



CATÁLOGO

K25

575

TC	TERMOS E CONDIÇÕES Página 5	09	FERRAMENTA ELÉTRICA Página 353-362
SB	SIMBOLOGIA Página 7	10	FERRAMENTA PNEUMÁTICA Página 365-378
01	FERRAMENTA MANUAL Página 11-106	11	FERRAMENTA HIDRÁULICA Página 381-404
02	ALICATES Página 109-120	12	FERRAMENTA LUBRIFICAÇÃO Página 407-414
03	BITS E CONJUNTOS Página 123-134	13	EQUIPAMENTO GARAGEM Página 417-502
04	FERRAMENTA ESPECÍFICA Página 137-214	RT	ROUPA DE TRABALHO Página 505-508
05	FERRAMENTA CARROÇARIA Página 217-222	MR	MERCHANDISING Página 511-514
06	REGULAÇÃO E TESTE Página 225-246	EP	EXPOSITORES Página 517-524
07	FERRAMENTA MOTOR Página 249-276	LR	LOCALIZAÇÃO REFERÊNCIAS Página 527-538
08	KITS SINCRONIZAÇÃO Página 279-350		

ÍNDICE

TC	TERMINOS Y CONDICIONES Página 6	09	HERRAMIENTA ELÉCTRICA Página 353-362
SB	SIMBOLOGÍA Página 8	10	HERRAMIENTA NEUMÁTICA Página 365-378
01	HERRAMIENTA MANUAL Página 11-106	11	HERRAMIENTA HIDRÁULICA Página 381-404
02	ALICATES Página 109-120	12	HERRAMIENTA LUBRICACIÓN Página 407-414
03	PUNTAS Y CONJUNTOS Página 123-134	13	EQUIPAMIENTO PARA TALLER Página 417-502
04	HERRAMIENTA ESPECÍFICA Página 137-214	RT	ROPA DE TRABAJO Página 505-508
05	HERRAMIENTA DE CARROCERIA Página 217-222	MR	MERCHANDISING Página 511-514
06	REGULACIÓN Y PRUEBAS Página 225-246	EP	EXPOSITORES Página 517-524
07	HERRAMIENTA PARA MOTOR Página 249-276	LR	LOCALIZACIÓN REFERENCIAS Página 527-538
08	KIT CALADO Página 279-350		

I - Âmbito de Aplicação

- a) As condições estabelecem os princípios gerais de venda e serviços pelos quais se devem pautar as relações entre a Kroftools e os seus clientes.

II - Fornecimentos

- a) Para abertura de crédito, será necessária a aprovação da Companhia de Seguros Coface e segundo critérios internos estabelecidos. A análise de concessão será feita após preenchimento de questionário em impresso próprio, pelo cliente.
- b) As faturas têm um prazo de 60 dias. No caso do crédito ser aprovado, a primeira encomenda será a pré-pagamento.
- c) A Kroftools reserva-se no direito de, em qualquer momento, cancelar os fornecimentos, nomeadamente nos casos em que os limites de crédito, em valor ou em prazo sejam ultrapassados.
- d) No caso de não apresentar os requisitos necessários para obtenção de crédito a mercadoria será enviada a pronto pagamento ou outra condição previamente acordada com a Kroftools.

III - Preços

- a) As encomendas aceitam-se nas condições bem expressas de que nos reservam o direito de alterar tanto o preço como os descontos estabelecidos enquanto não faturado (em virtude de alterações de preço de fabrico, câmbios, etc.) sem obrigatoriedade de aviso prévio.

IV - Expedição

- a) O transportador será escolhido pela Kroftools, salvo indicação contrária por parte do cliente.
- b) Os portes são por conta do cliente, salvo acordo entre a Kroftools e o cliente.
- c) A entrega considera-se feita no estabelecimento do cliente ou no local onde o cliente ou qualquer representante desta o receba.
- d) É responsabilidade do cliente no ato e receção do pedido, verificar o número de volumes e estado dos mesmos, devendo efetuar no momento a reclamação à transportadora de qualquer erro / defeito detetado. A Kroftools não se responsabilizará por qualquer reclamação posterior por danos e/ou perdas de material onde fique comprovado que as mesmas eram detetáveis no ato de receção.

V - Reclamações, devoluções

- a) As reclamações e/ou devoluções relativas a fornecimentos só são aceites no prazo máximo de quinze dias a contar da data de receção da mercadoria. Qualquer reclamação fora desse prazo, deverá ser formalizada com o respetivo justificativo para análise do Departamento Comercial.
- b) A mercadoria a devolver terá de ser sempre acompanhada por uma Nota de Devolução com menção de número(s) de documento(s) a que respeita o(s) artigo(s) devolvido (artigo 36º alínea b do código do Civa), ou cópia do documento de venda.
- c) Não serão aceites devoluções de artigos rececionados, com marcas de utilização ou danos na embalagem original

VI - Garantias

- a) Todos os produtos têm garantia prevista na lei.
- b) Para beneficiar da garantia, o cliente deverá informar a Kroftools no prazo máximo de 2 semanas a contar da data de deteção da falta de conformidade do produto.
- c) O material enviado para garantia deverá vir acompanhado por documento onde identifique data de compra e/ou data de venda ao consumidor final, assim como descritivo do problema detetado no equipamento.
- d) A Kroftools não se responsabiliza por situações em que o material não se encontre em conformidade com os desenhos ou especificações de fábrica.

VII - Pagamentos

Condições gerais de pagamento:

- a) A data do vencimento das faturas é de 60 dias, no caso de existir aprovação de crédito por parte da seguradora.
- b) A Kroftools reserva-se no direito de debitar juros de mora à taxa legal nos atrasos de pagamento de documentos vencidos e não pagos.
- c) A Kroftools reserva-se no direito de alterar as condições gerais em qualquer altura.

VIII - Dados Bancários

SANTANDER TOTTA IBAN: PT50 0018 000332301673020 43
SWIFT/BIC: TOTAPTPL
BANKINTER IBAN: PT50 0269 066300209377509 04
SWIFT/BIC: BKBKPTPL
BPI IBAN: PT50 0010 0000 16151620001 86
SWIFT/BIC: BBPIPTPL
CGD IBAN: PT50 0035 0776 00000462130 60
SWIFT/BIC: CGDIPTPL
CCAM IBAN: PT50 0045 1450 40314809010 93
SWIFT/BIC: CCCMPTPL

IX - Compartilhamento de Dados (RGPD)

- a) A kroftools responsabiliza-se pelo uso dos dados dos nossos clientes única e exclusivamente para efeitos comerciais.
- b) Serão partilhados com terceiros apenas os dados necessários à expedição das mercadorias.
- c) É responsabilidade do distribuidor Kroftools assegurar a boa prática da RGPD no fornecimento de dados de terceiros (consumidor final).

X - Outros

- a) Para julgar toda ou qualquer ação judicial, o Tribunal da Comarca de Braga é o único competente.

I - Ámbito de Aplicación

- a) Los términos y condiciones establecen los principios generales de venta y servicio que deben guiar la relación entre Kroftools y sus clientes.

II - Suministros

- a) Para abrir un préstamo, será necesaria la aprobación de la Compañía de Seguros Coface, de acuerdo con los criterios internos establecidos. El proceso de aprobación se analizará después de que el cliente haya cumplimentado un cuestionario en un formulario aparte.
b) Las facturas vencen a los 60 días. Si se aprueba el crédito, el primer pedido se pagará por adelantado.
c) Kroftools se reserva el derecho de cancelar las entregas en cualquier momento, especialmente en los casos en que se superen los límites de crédito, en términos de valor o de tiempo.
d) Si no cumple los requisitos para obtener crédito, la mercancía le será enviada al contado o bajo otra condición previamente acordada con Kroftools.

III - Precios

- a) Los pedidos se aceptan con la condición expresa de que nos reservamos el derecho a modificar sin previo aviso tanto el precio como los descuentos establecidos mientras no se facturen (debido a variaciones en los precios de fabricación, tipos de cambio, etc.).

IV - Envío

- a) El transporte será elegido por Kroftools, salvo que el cliente indique lo contrario.
b) Los gastos de envío correrán a cargo del cliente, salvo acuerdo entre Kroftools y el cliente.
c) La entrega se considerará efectuada en los locales del cliente o en el lugar donde el cliente o cualquier representante del mismo la reciba.
d) Es responsabilidad del cliente al recibir el pedido comprobar el número de bultos y su estado, así como reclamar con el transporte cualquier error / defecto detectado en el momento. Kroftools no se hará responsable de reclamaciones posteriores por daños y/o pérdidas de material cuando se demuestre que eran detectables en el momento de la recepción.

V - Reclamaciones, Devoluciones

- a) Sólo se aceptarán reclamaciones y/o devoluciones relativas a entregas en un plazo máximo de ocho días desde la fecha de recepción de la mercancía. Cualquier reclamación fuera de este plazo deberá formalizarse con la correspondiente justificación para su análisis por el departamento de Ventas.
b) La mercancía a devolver debe ir siempre acompañada de una Nota de Devolución en la que se mencione el número o números de documento a los que se refiere el artículo o artículos devueltos (artículo 36(b) del código Civa), o de una copia del artículo de venta.
c) No se aceptarán devoluciones de artículos recibidos con marcas de uso o daños en el embalaje original.

VI - Garantías

- a) Todos los productos están garantizados por ley.
b) Para beneficiarse de la garantía, el cliente deberá informar a Kroftools en un plazo máximo de 2 semanas a partir de la fecha de detección de la falta de conformidad del producto.
c) El material enviado en garantía debe ir acompañado de un documento que identifique la fecha de compra y/o la fecha de venta al consumidor final, así como una descripción del problema detectado en el equipo.
d) Kroftools no se hace responsable de situaciones en las que el material no se ajuste a los planos o especificaciones de fábrica.

VII - Pago

Condiciones generales de pago

- a) La fecha de vencimiento de las facturas es de 60 días, en caso de aprobación del crédito por parte de la aseguradora.
b) Kroftools Lda se reserva el derecho de cobrar intereses al tipo legal por demora en el pago de documentos vencidos e impagados.
c) Kroftools se reserva el derecho de modificar las condiciones generales en cualquier momento.

VIII - Datos Bancarios

SANTANDER TOTTA IBAN: PT50 0018 000332301673020 43
SWIFT/BIC: TOTAPTPL
BANKINTER IBAN: PT50 0269 066300209377509 04
SWIFT/BIC: BKBKPTPL
BPI IBAN: PT50 0010 0000 16151620001 86
SWIFT/BIC: BBPIPTPL
CGD IBAN: PT50 0035 0776 00000462130 60
SWIFT/BIC: CGDIPTPL
CCAM IBAN: PT50 0045 1450 40314809010 93
SWIFT/BIC: CCCMPTPL

IX - Intercambio de datos (GDPR)

- a) Kroftools es responsable del uso de los datos de nuestros clientes única y exclusivamente con fines comerciales.
b) Sólo se compartirán con terceros los datos necesarios para el envío de las mercancías.
c) Es responsabilidad del distribuidor de kroftools garantizar las buenas prácticas del GDPR en el suministro de datos de terceros (consumidor final).

X - Otros

- a) El Tribunal de Braga es el único competente para conocer de cualquier acción judicial.

 Quantidade por caixa	 Peso líquido artigo	 Altura	 Comprimento	 Hexagonal
 Bi-hexagonal	 Torx	 Bit hexagonal	 Fenda	 Bit Torx
 Bit Phillips	 Bit Pozidriv	 Bit Torx Furado	 Ribe Furado	 Bit Ribe
 Bit Torx TS	 Bit XZN	 Bit XZN furado	 Bit Quadrado	 Bit hex furado
 Martelo mecânico	 Martelo Bola	 Abraçadeira	 Quadra	 Abertura
 Diâmetro	 Medidas Gerais	 Magnetismo	 Capacidade Líquido	 Capacidade Peso
 Rotação	 Quantidade	 Pressão manómetro	 Temperatura	 Amperagem Voltagem
 Bidón	 Cilindrada motor	 Iluminação	 Carregamento	 Comprimento Cabo
 Diâmetro	 Desaperto	 Aperto	 Abertura	 Peso suportado
 Informação	 Escala	 Voltagem Motor	 Bit Clutch	 Bit Torq
	 Bit Triwing	 Bit Spanner	 Bit Torx Plus	
		 Bit Robertson		



Cantidad por caja



Peso neto



Altura



Longitud



Hexagonal



Bihexagonal



Torx



Punta hexagonal



Plano



Punta torx



Punta Phillips



Punta Pozidriv



Punta Torx Inviolable



Ribe inviolable



Punta Ribe



Punta Torx TS



Punta XZN



Punta XZN inviolable



Punta Cuadrada



Punta Hex inviolable



Martillo mecánico



Martillo Bola



Abrazadera



Cuadrado



Apertura



Diámetro



Medidas Generales



Magnetismo



Capacidad Líquido



Capacidad Peso



Rotación



Cantidad



Presión manómetro



Temperatura



Amperaje Tensión



Bidón



Cilindrada motor



Iluminación



Cargamento



Longitud Cable



Diámetro



Afloje



Apriete



Apertura



Peso soportado



Información



Escala



Voltaje motor



Punta Clutch



Punta Torq



Punta Triwing



Punta Spanner



Punta Torx Plus



Punta Cuadrada

FERRAMENTA MANUAL
HERRAMIENTA MANUAL

01



 FAMÍLIA	PÁGINAS
01 FERRAMENTA MANUAL	11-106
02 ALICATES	109-120
03 BITS E CONJUNTOS	123-134
04 FERRAMENTA ESPECÍFICA	137-214
05 FERRAMENTA CARROÇARIA	217-222
06 REGULAÇÃO E TESTE	225-246
07 FERRAMENTA MOTOR	249-276
08 KITS SINCRONIZAÇÃO	279-350
09 FERRAMENTA ELÉTRICA	353-362
10 FERRAMENTA PNEUMÁTICA	365-378
11 FERRAMENTA HIDRÁULICA	381-404
12 FERRAMENTA LUBRIFICAÇÃO	407-414
13 EQUIPAMENTO GARAGEM	417-502
RT ROUPA DE TRABALHO	505-508
MR MERCHANDISING	511-514
EP EXPOSITORES	517-524
LR LOCALIZAÇÃO REFERÊNCIAS	527-538

 FAMILIA	PÁGINAS
01 HERRAMIENTA MANUAL	11-106
02 ALICATES	109-120
03 PUNTAS Y CONJUNTOS	123-134
04 HERRAMIENTA ESPECÍFICA	137-214
05 HERRAMIENTA DE CARROCERIA	217-222
06 REGULACIÓN Y PRUEBAS	225-246
07 HERRAMIENTA PARA MOTOR	249-276
08 KIT CALADO	279-350
09 HERRAMIENTA ELÉCTRICA	353-362
10 HERRAMIENTA NEUMÁTICA	365-378
11 HERRAMIENTA HIDRÁULICA	381-404
12 HERRAMIENTA LUBRICACIÓN	407-414
13 EQUIPAMENTO PARA TALLER	417-502
RT ROPA DE TRABAJO	505-508
MR MERCHANDISING	511-514
EP EXPOSITORES	517-524
LR LOCALIZACIÓN REFERENCIAS	527-538



 Bancada trabalho móvel 1.14x0.73M
 Banco de trabajo móvil 1.14x0.73M

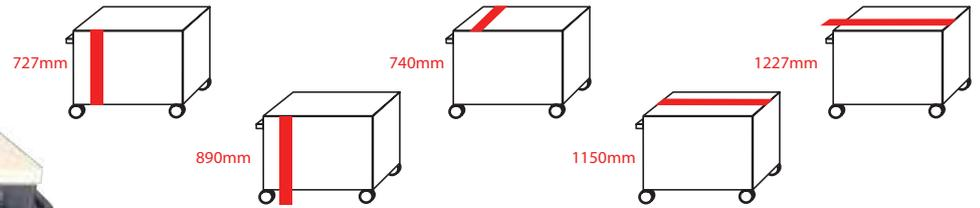

 **Medidas gavetas:**
(6x) 570x410x83mm
(2x) 570x410x112mm
(2x) 570x410x228mm

Medidas armário:
600x190x600mm

 **Dimensiones de los cajones:**
(6x) 570x410x83mm
(2x) 570x410x112mm
(2x) 570x410x228mm

Medidas del armario:
600x190x600mm

REF

8700



140kg



1x

 Bancada de trabalho com gavetas 2,85M
 Banco de trabajo con cajones 2,85M

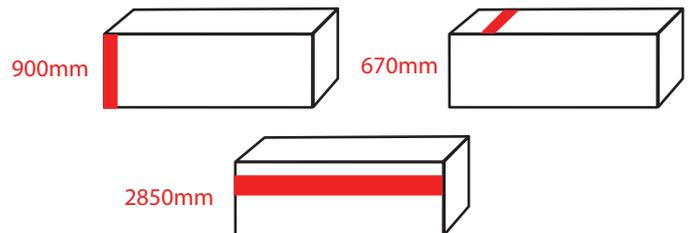
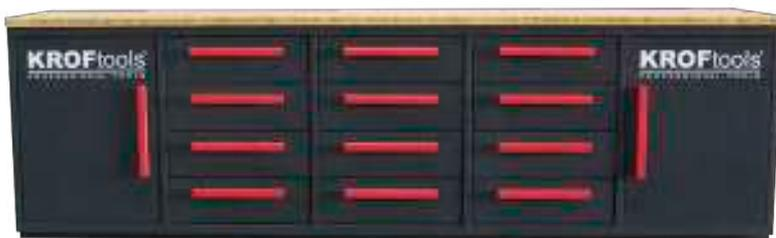

 **Características:**
Dimensões: 2850x670x900mm
Espessura bamboo topo: 35mm
Espessura: aço estrutura 0.9mm, aço gavetas: 0.7mm
Capacidade de carga máxima (total): 500kg; 35kg (gavetas); 45kg (armários)
Medidas gavetas: 505x133x600mm
Armário: 600x560x680mm

 **Características:**
Dimensiones: 2850x670x900mm
Espesor de la cubierta de bambú: 35 mm
Espesor: estructura de acero de 0,9 mm, cajones de acero: 0,7 mm
Capacidad de carga máxima (total): 500 kg; 35 kg (cajones); 45 kg (armarios)
Dimensiones cajones: 505x133x600mm
Armario: 600x560x680mm

REF

8670



206kg



1x

 Carro trabalho 72" - 15 gavetas

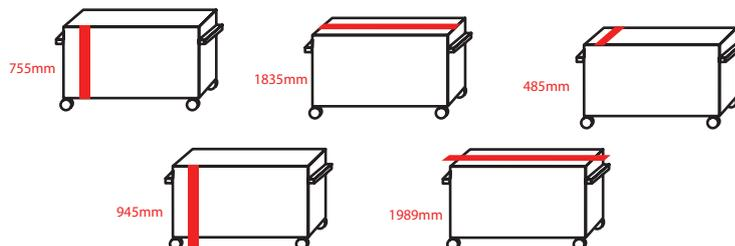
 Carro trabajo 72" - 15 cajones

 **Medidas gavetas:**

(6x) 397mmx75mm, (2x) 397mmx235mm, (3x) 877mmx75mm, (1x) 877mmx152mm, (2x) 397mmx152mm, (1x) 877mmx235mm

Descrição:

Tampo de madeira com 30mm de espessura
 (2x) Pegas laterais
 (2x) Rodas giratórias 150mm com travão
 (2x) Rodas giratórias 150mm
 Gavetas com forro

 **Medidas cajones:**

(6x) 397mmx75mm, (2x) 397mmx235mm, (3x) 877mmx75mm, (1x) 877mmx152mm, (2x) 397mmx152mm, (1x) 877mmx235mm

Descripción:

Tapa de madera con 30mm de espesor
 (2x) Asas laterales
 (2x) Ruedas giratorias de 150mm con freno
 (2x) Ruedas giratorias de 150mm
 Cajones con forro

REF

8672



105kg



1x

 Carro trabalho 84" c/ led e tomada elétrica

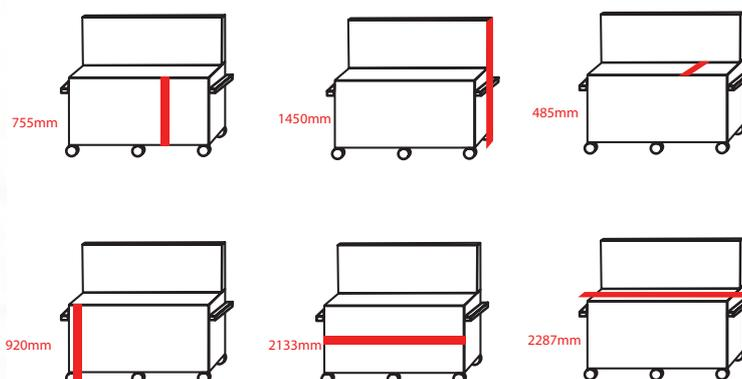
 Carro trabajo 84" con led y toma eléctrica

Kit 13 ganchos

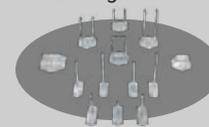

REF 8630G

 **Medidas gavetas:**

(3x) 950,2x398,2x65,7mm
 (1x) 950,2x398,2x144,7mm
 (1x) 950,2x398,2x224,7mm
 (3x) 430,7x398,2x65,7mm
 (1x) 430,7x398,2x144,7mm
 (1x) 430,7x398,2x224,7mm

 **Medidas cajones:**

(3x) 950,2x398,2x65,7mm
 (1x) 950,2x398,2x144,7mm
 (1x) 950,2x398,2x224,7mm
 (3x) 430,7x398,2x65,7mm
 (1x) 430,7x398,2x144,7mm
 (1x) 430,7x398,2x224,7mm

REF

8631



145kg



1x

 Carro trabalho 61" - 9 gavetas
 Carro trabajo 61" - 9 cajones

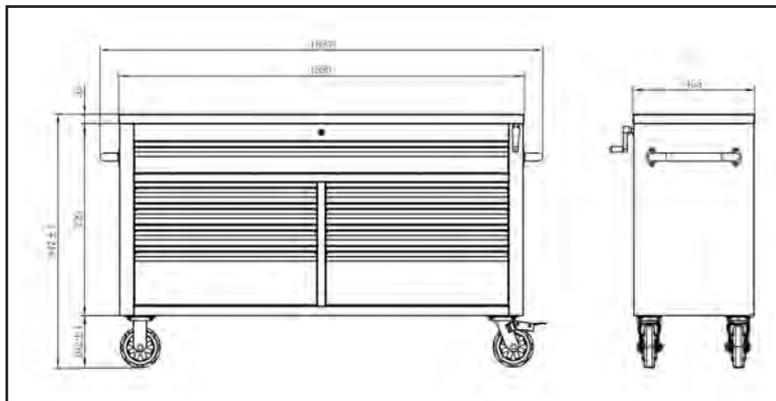

Descrição:
(1x) Tampo de madeira com 35mm de espessura
(2x) Pegas laterais
(9x) Gavetas corrediças com capacidade de 45kg (com forro)
(2x) Rodas giratórias de 101,6x152,4mm (4x6") com travão
(2x) Rodas giratórias de 101,6x152,4mm (4x6") sem travão
(2x) Chaves incluídas

Descripción:
(1x) Tapa de madera de 35mm de grosor
(2x) Mangos laterales
(9x) Cajones guía con capacidad de 45kg (forrados)
(2x) Ruedas giratorias de 101,6x152,4mm (4x6") con freno
(2x) Ruedas giratorias de 101,6x152,4mm (4x6") sin freno
(2x) Llaves incluida

REF		
8661	110kg	1x

 Carro ferramenta 14 gavetas
 Carro herramientas 14 cajones

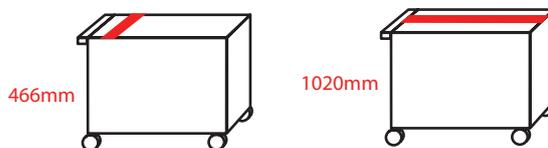
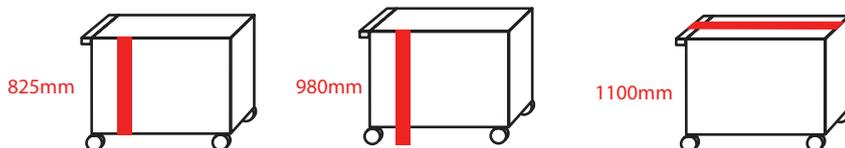

Dimensões gavetas:
Grandes:
(5x) 560x395x65mm
(2x) 560x395x145mm
Pequenas:
(5x) 250x395x65mm
(2x) 250x395x145mm

Dimensiones cajones:
Grandes:
(5x) 560x395x65mm,
(2x) 560x395x145mm
Pequeños:
(5x) 250x395x65mm,
(2x) 250x395x145mm

REF		
8660	90,2kg	1x

-  Carro de ferramenta 7 gavetas vazio
 Carro de herramientas 7 cajones vacio



Possibilidade de escolha na cor:

Possibilidad de elegir en color:

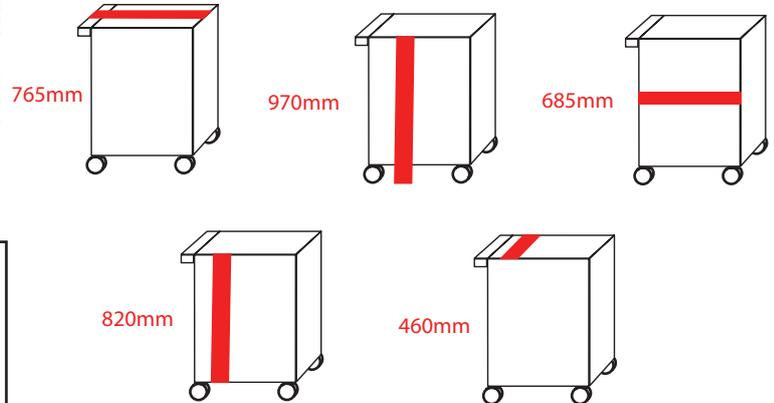

-  **Dimensões gavetas:**
 (5x) Gaveta S: 538 x 397 x 67mm
 (1x) Gaveta M: 538 x 397 x 125mm
 (1x) Gaveta L: 538 x 397 x 145mm

-  **Dimensiones cajones:**
 (5x) Cajón S: 538 x 397 x 67mm
 (1x) Cajón M: 538 x 397 x 125mm
 (1x) Cajón L: 538 x 397 x 145mm

REF

8611



51kg



1x

-  Carrinho com 3 prateleiras
 Carro con 3 bandejas

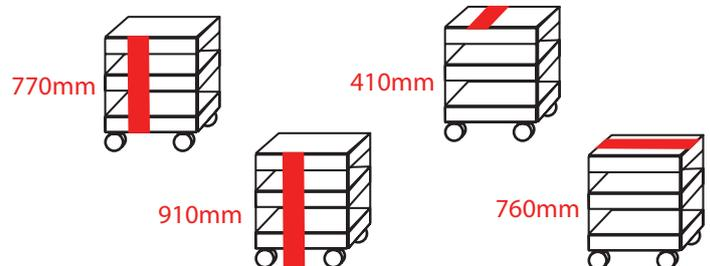

-  **Características:**
 Espessura colunas: 1.2mm
 Espessura bandejas: 0.7mm
 Peso máximo suportado por bandeja: 50kg
 (4x) Ruedas 4"

-  **Características:**
 Espesor columnas: 1.2mm
 Espesor bandejas: 0.7 mm
 Peso máximo suportado por bandeja: 50kg
 (4x) Ruedas 4"

REF

8590



14,6kg



1x

 Carrinho 3 prateleiras com suportes
 Carro 3 bandejas con soportes

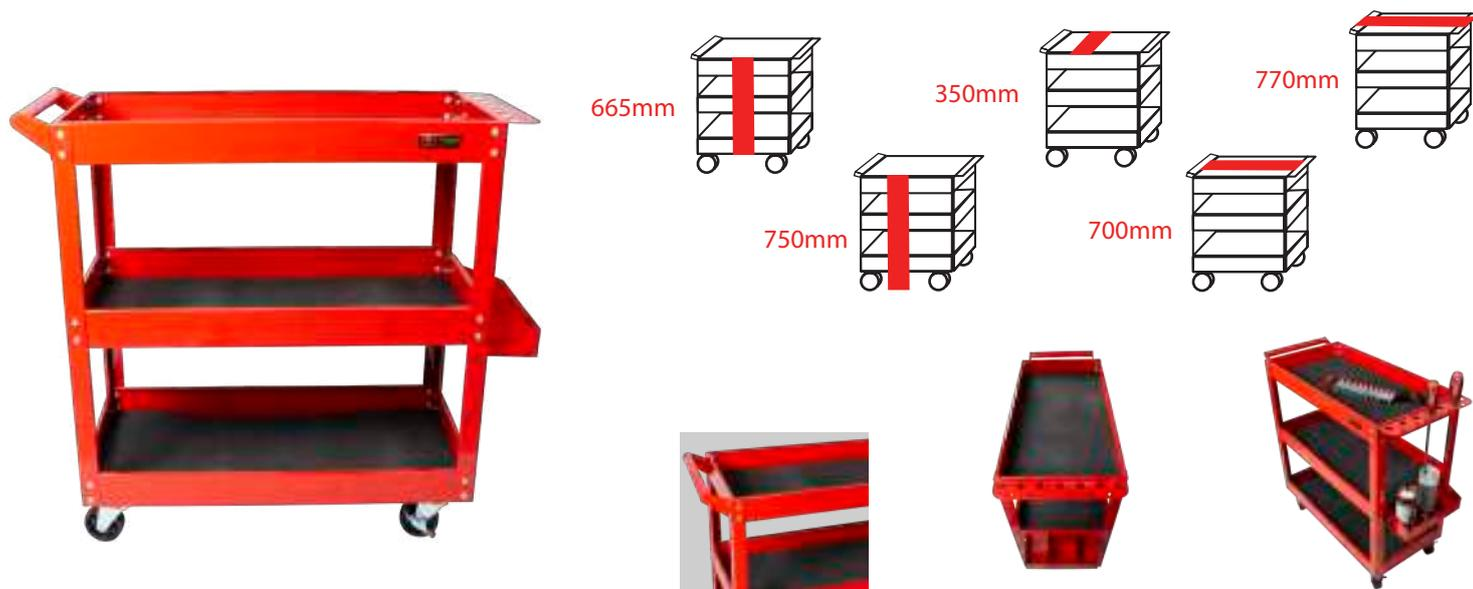

 **Acessórios:**
(1x) Pega
(1x) Porta ferramentas
(1x) Caixa para peças
(4x) Rodas 3" (2x com travão)
Peso máximo suportado por prateleira 20kg

 **Accesorios:**
(1x) Mango
(1x) Porta herramientas
(1x) Caja para piezas
(4x) Ruedas 3" (2x con frenos)
Peso máximo suportado por estante 20kg

REF		
8690	10,4kg	1x

 Suporte papel magnético
 Soporte papel magnético



 **Características:** Suporte para caixa de luvas ou papel descartável com tamanho padrão. Com quatro ímanes que mantém o suporte fixado
Capacidade ímanes: 3,6kg
Dimensões: 143x95x253mm

 **Características:** Soporte para guanteras o papel desechable de tamaño estándar. Compuesto por cuatro imanes que mantienen fijo el soporte
Capacidad del ímán: 3,6 kg
Dimensiones: 143x95x253mm

REF		
8632	958gr	24x

 Suporte sprays magnético
 Soporte sprays magnético



 **Características:** Suporte para lata de spray e duas chaves de punho. Três ímanes revestidos para não riscar as superfícies. Conecta-se facilmente a uma caixa de ferramentas ou qualquer superfície de metal. Construção de aço resistente.

 **Características:** Soporte para latas y destornilladores. Tres imanes revestidos para evitar rayar las superficies. Se conecta fácilmente a una caja de herramientas o cualquier superficie metálica. Construcción robusta de acero.

REF		
8633	416gr	12x

 Suporte chaves magnético
 Soporte llaves magnético



 **Características:**
 Suporte magnético, segura até 12 chaves
 Capacidade até 3,5kg
 Possibilidade de fixar na parede
 Fabrico em ABS para maior resistência

 **Características:**
 Soporte magnético, admite hasta 12 llaves
 Capacidad hasta 3,5kg
 Posibilidad de fijar en la pared
 Fabricado en ABS para mayor resistencia

REF

8634



708gr



24x

 Armário lateral para carro de ferramentas
 Armário lateral para carro de herramientas



50mm



297mm



670mm



REF

8530



5kg



1x

 Divisões para gavetas do carro de ferramentas
 Divisiones para cajones de carro de herramientas

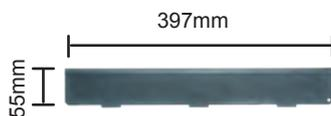

8581

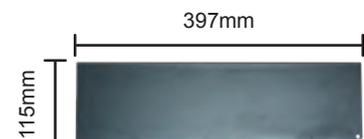

8582

REF

8581
85821kg
1kg1x
1x

- Gancho de suporte para carro de ferramentas
- Gancho de soporte para carro de herramientas



Dimensões:
8535: 50mm comprimento
8536: 75mm comprimento

Dimensiones:
8535: 50mm longitudud
8536: 75mm longitudud

REF			
8535	10gr		1x
8536	10gr		1x

- Módulo 42 peças chaves de caixa 1/4"
- Módulo 42 piezas llaves de vaso 1/4"



9x			5, 6, 7, 8, 9, 10, 11,12, 13mm
23x			T8, T10, T15, T20, T25, T27, T30, T40
			PH1, 2, 3; PZ1, 2, 3
			4, 5.5, 7; H 3, 4, 5, 6, 7, 8mm
10x			1.5, 2, 2.5, 3, 4, 5, 5.5, 6, 8, 10mm

REF			
8510	385x170mm	1,08kg	10x

- Módulo 20 peças chaves de caixa 3/8" 8-24mm
- Módulo 20 piezas llaves de vaso 3/8" 8-24mm



15x			8, 9, 10, 11, 12, 13, 14, 15, 16, 17, 18,19, 21, 22, 24mm
1x			3/8" 50mm
1x			3/8" 160mm
2x			3/8" 75mm, 150mm
1x			3/8"

REF			
8573	385x170mm	1,44kg	10x

 Módulo 19 peças chaves de caixa 1/4"

 Módulo 19 piezas llaves de vaso 1/4"



Módulo vazio / Módulo vacío



REF 8511V

13x			4, 4.5, 5, 5.5, 6, 7, 8, 9, 10, 11, 12, 13, 14mm
1x			1/4" 40mm
1x			1/4" 115mm
2x			1/4" 50mm, 100mm
1x			1/4"
1x			1/4"

REF

8511



385x170mm



640gr



5x

 Módulo 25 peças chaves de caixa e roquete 1/2"

 Módulo 25 piezas llaves de vaso y carraca 1/2"



Módulo vazio / Módulo vacío



REF 8515V

20x			8, 10, 11, 12, 13, 14, 15, 16, 17, 18, 19, 20, 21, 22, 23, 24, 27, 28, 30, 32mm
1x			1/2"
1x			1/2" 250mm
2x			1/2" 125mm, 250mm
1x			1/2"

REF

8515



385x170mm



3,56kg



5x

 Módulo chaves caixa 1/2" bihexagonal 21 peças

 Módulo llaves vaso 1/2" bihexagonal 21 piezas



21x			8, 9, 10, 11, 12, 13, 14, 15, 16, 17, 18, 19, 20, 21, 22, 24, 27, 30, 32, 34, 36mm
-----	---	---	--

REF

2125



375x170x30mm



2,18kg



5x

 Módulo 23 peças chaves caixa 1/2" impacto curtas e longas

 Módulo 23 piezas llaves de vaso 1/2" impacto cortas y largas



14x			8, 9, 10, 11, 12, 13, 14, 15, 16, 17, 18, 19, 20, 22mm
6x			13, 14, 15, 17, 18, 19mm
2x			1/2": 75mm, 125mm
1x			1/2"

REF

8604



385x170mm



2,9kg



10x

Módulo chaves caixa 1/2" isolada 20pcs
Módulo llaves de vaso 1/2" aisladas 20pzs



   1000V
IEC 60900

13x		10mm, 11mm, 12mm, 13mm, 14mm, 16mm, 17mm, 18mm, 19mm, 21mm, 22mm, 24mm, 27mm
4x		H4*80mm, H5*80mm, H6*80mm, H8*80mm
1x		1/2": 75mm, 125mm
1x		1/2": 200mm
1x		1/2": 250mm

REF			
8360	410x260mm	3kg	5x

Módulo chaves boca isoladas 24-32mm 4pcs
Módulo llaves bocas 4pzs 24-32mm aislada



   1000V
IEC 60900

4x		24mm, 27mm, 30mm, 32mm
----	--	------------------------

REF			
8361	390x240mm	1,8kg	10x

Módulo chaves boca isoladas 6-21mm 14pcs
Módulo llaves bocas 14pzs 6-21mm aislada



   1000V
IEC 60900

14x		6mm, 7mm, 8mm, 9mm, 10mm, 11mm, 12mm, 13mm, 14mm, 15mm, 16mm, 17mm, 19mm, 21mm
-----	--	--

REF			
8362	390x240mm	1,3kg	10x

Módulo chaves luneta isoladas 7-19mm 8pcs
Módulo llaves estrella aisladas 7-19mm 8pzs



   1000V
IEC 60900

8x		7mm, 8mm, 10mm, 12mm, 13mm, 14mm, 17mm, 19mm
----	--	--

REF			
8364	390x240mm	1,26kg	10x

Módulo chaves em L hexagonal Isoladas 3-12mm 7pcs
 Módulo llaves en L aisladas 7pzs 3-12mm



7x		3mm, 4mm, 5mm, 6mm, 8mm, 10mm, 12mm
----	--	-------------------------------------

REF			
8363	390x240mm	1,17kg	10x

Módulo alicates/fita/chave inglesa isolada 8pcs
 Módulo herramientas aisladas 8pzs



1x		250mm
1x		6"
1x		10"
1x		160mm
3x		10/20/30mm
1x		Isolante / aislante

REF			
8365	390x240mm	1,45kg	10x

Módulo chaves luneta longas 8-19mm 6pcs
 Módulo llaves estrella extra largas 8-19mm 6pzs



6x		CR-V - 8x9mm, 10x12mm, 11x13mm, 14x15mm, 16x17mm, 18x19mm
----	--	---

REF			
8366	390x240mm	1,7kg	10x

Módulo mini roquetes + acessórios 12pcs
 Kit mini carracas con accesorios 12pzs



3x		1/4", 3/8", 1/2"
3x		1/4" x 150mm, 3/8" x 250mm, 1/2" x 350mm
3x		1/4" x 100mm, 3/8" x 125mm, 1/2" x 125mm
3x		Adaptadores

REF			
8368	390x240mm	2,56kg	10x

 Módulo chaves pé de galo 3/8" 25pcs
 Módulo llaves pies de gallo 25pzs

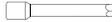

13x		8mm, 9mm, 10mm, 11mm, 12mm, 13mm, 14mm, 15mm, 16mm, 17mm, 18mm, 19mm, 22mm
9x		SAE: 5/16", 3/8", 7/16", 1/2", 9/16", 5/8", 11/16", 3/4", 7/8"
2x		75mm, 150mm
1x		250mm

REF			
8369	390x240mm	1,8kg	10x

 Módulo chave dinamométrica 1/2" + acessórios 8pcs
 Módulo llave dinamométrica con accesorios 8pzs



1x		1/2" - 20-120Nm
3x		1/2"- 17mm, 19mm, 21mm
1x		1/2" - 125mm
1x		Para marcação / para marcar
1x		Para pneus / para neumáticos
1x		Magnético / magnética

REF			
8367	390x240mm	2,4kg	10x

 Módulo 4 alicates
 Módulo 4 alicates



Módulo vazio / Módulo vacío



REF 8605V

1x		200mm
1x		200mm
1x		150mm
1x		180mm

REF			
8605	385x170mm	1,23kg	10x

 Módulo 3 alicates
 Módulo 3 alicates

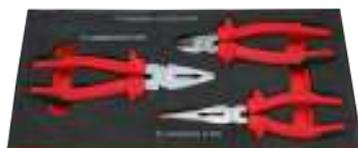

Módulo vazio / Módulo vacío



REF 8512V

1x		7.5"
1x		8"
1x		8"

REF			
8512	385x170mm	1,03kg	1x

 Módulo 3 alicates isolados (1000v)
 Módulo 3 alicates aislados (1000v)



1x		150mm
1x		150mm
1x		180mm

REF			
8600	385x170mm	1,3kg	1x

 Módulo 3 alicates extra longos
 Módulos 3 alicates extralargos



1x		280mm
1x		90° 250mm
1x		45° 280mm

REF			
8593	385x170mm	1,3kg	10x

 Módulo 4 alicates para chapeiro
 Módulo alicates carroceiro 4pzs



1x		150mm Ø
1x		280mm
1x		240mm
1x		160mm

REF			
8576	385x345mm	2,5kg	5x

 Módulo 3 alicates de pressão
 Módulo 3 mordazas grip



1x		7" - 180mm
1x		6" - 150mm
1x		10" - 250mm

REF			
8601	385x170mm	1,1kg	10x

 Módulo alicates pressão bloqueio automático 3pcs
 Módulo 3pzs mordazas grip autoajustable automatica



Módulo vazio / Módulo vacío



REF 2406V

1x		7" - 203mm
1x		6" - 173mm
1x		10" - 244mm

REF			
2406	385x170mm	1,26kg	10x

Módulo 2 alicates
Módulo alicates 2pzs



Módulo vazio / Módulo vacío



REF 8523V

1x		250mm
1x		250mm

REF			
8523	385x170mm	990gr	10x

Módulo 4 alicates de freios
Módulo 4 alicates de arandelas



Módulo vazio / Módulo vacío



REF 8513V

1x		175mm
1x		175mm
1x		175mm
1x		175mm

REF			
8513	385x170mm	1kg	1x

Módulo 4 alicates de freios
Módulo 4 alicates de arandelas



1x		175mm
1x		175mm
1x		175mm
1x		175mm

REF			
14001	380x170mm	920gr	5x

Módulo 101 peças alicates de rebites e rebites
Módulo 101 piezas remachadora y remaches



Módulo vazio / Módulo vacío



REF 8529V

1x		
25x		2,5mm Ø
25x		3mm Ø
25x		4mm Ø
25x		5mm Ø

REF			
8529	385x170mm	1kg	1x

 Módulo 8 peças chaves em T articuladas

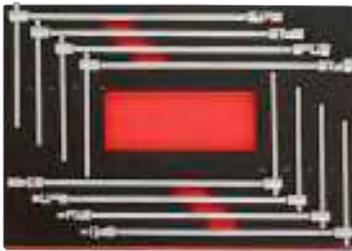
 Módulo 8 piezas llaves en T articuladas

Módulo vazio / Módulo vacío



REF 8607V

Módulo vazio / Módulo vacío

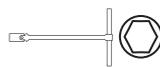

REF 8607VV

8x		T6x400mm, T8x400mm, T10x400mm, T12x400mm, T13x400mm, T14x400mm, T17x400mm, T19x400mm
----	--	--

REF			
8607	375x345mm	3,2kg	5x

 Módulo 6 peças chaves T torx



 Módulo 6 piezas llaves T torx

6x		T10x100mm, T15x100mm, T20x100mm, T25x150mm, T27x150mm, T30x150mm
----	--	--

REF			
8608	385x170mm	550gr	10x

 Módulo chaves de caixa hexagonal em T 4 pcs

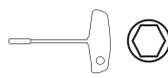
 Módulo llave de vaso hex en T 4 pzs

4x		7mm, 8mm, 10mm, 13mm
----	--	----------------------

REF			
8588	385x170mm	1,3kg	1x

 Módulo 6 chaves em T umbrako

 Módulo 6 llaves en T umbrako

Módulo vazio / Módulo vacío



REF 8514V

6x		2x100mm, 2.5x100mm, 3x100mm, 4x150mm, 5x150mm, 6x150mm
----	--	--

REF			
8514	385x170mm	880gr	10x

Módulo 6 chaves de caixa hexagonais com punho
Módulo 6 llaves de vaso hexagonales con mango

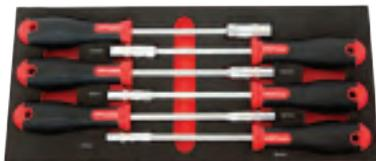

6x		6mm, 7mm, 8mm, 9mm, 10mm, 12mm
----	--	--------------------------------

REF			
8589	385x170mm	1,3kg	1x

Módulo 7 chaves de punho Torx T10-T40
Módulo 7 destornilladores Torx T10-T40

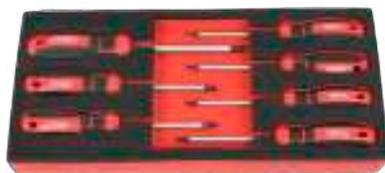

7x		T10x100mm, T15x100mm, T20x100mm, T25x100mm, T27x100mm, T30x100mm, T40x125mm
----	--	---

REF			
8519	385x170mm	800gr	10x

Módulo 7 peças chaves de fenda e cruz isoladas
Módulo 7 piezas destornillador planos y phillips aislados

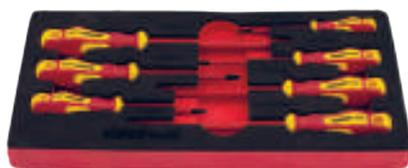

3x		PH1x80mm, PH2x100mm, PH3x150mm
4x		SL3x75mm, SL4x100mm, SL5.5x125mm, SL6.5x150mm

REF			
8599	385x170mm	700gr	10x

Módulo 8 chaves de fenda e cruz
Módulo 8 destornilladores planos y phillips

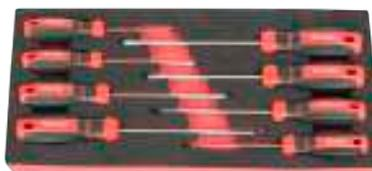

4x		PH2x38mm, PH1x100mm, PH2x100mm, PH3x150mm
4x		6x38mm, 4x100mm, 5x100mm, 6x150mm

REF			
8520	385x170mm	750gr	10x

 Módulo 14 peças chaves fenda e cruz eletrônica
 Módulo 14 piezas destorn. planos y phillips electrónica



4x			3x75mm, 4x100mm, 5.5x125mm, 6.5x150mm
4x			1.8mm, 2mm, 2.4mm, 3mm
2x			PH1x100mm, PH2x100mm
3x			PH0, PH00, PH000
1x			T9, T10, T15, T20, T25, T27, T30, T40

REF			
8570	385x170mm	1kg	5x

 Módulo 85 peças bits
 Módulo 85 piezas puntas



Módulo vazio / Módulo vacío



REF 8516V

1/4" x25mm	7x		T10H, T15H, T20H, T25H, T27H, T30, T40H	 
	7x		T10, T15, T20, T25, T27, T30, T40	
	3x		4mm, 5mm, 6mm	
	6x		PH1, PH1, PH2, PH2, PH3, PH3	
	6x		PZ1, PZ1, PZ2, PZ2, PZ3, PZ3	
	4x		4mm, 4mm, 6mm, 6mm	

10x30mm	7x		4mm, 4mm, 5mm, 5mm, 6mm, 7mm, 10mm	
	6x		T20, T25, T30, T40, T50, T55	
	5x		XZN: M5, M5, M6, M8, M10	
10x75mm	7x		4mm, 4mm, 5mm, 5mm, 6mm, 7mm, 10mm	
	6x		T20, T25, T30, T40, T50, T55	
	5x		XZN: M5, M5, M6, M8, M10	
	5x		1/4" - E4, E5, E6, E7, E8	
	7x		1/2" - E10, E11, E12, E14, E16, E18, E20	
	1x		1/2" x 10mm	
	1x		3/8" x 10mm	
	1x		1/4" magnético	
	1x		1/4" encaixe rápido	

REF			
8516	385x170mm	2,05kg	10x

 Módulo chaves bit hexagonal torx 1/2" 12pcs
 Módulo llave de vaso hexagonal 1/2" con punta xzn 12pzs

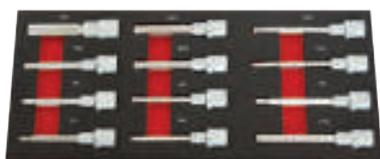

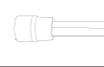
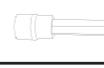
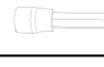
4x			T40x120mm, T45x120mm, T50x100mm, T70x100mm
4x			XZN: M6x100mm, M8x100mm, M10x100mm, M12x100mm
4x			6x120mm, 7x100mm, 8x100mm, 10x120mm

REF			
8603	385x170mm	1,3kg	1x

Módulo 43 peças chaves torx em L e torx interior
Módulo 43 piezas llaves torx en L y torx interior

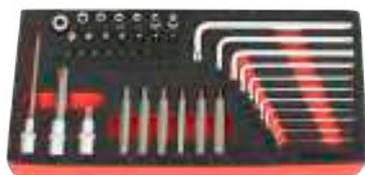

11x		T8, T10, T15, T20, T25, T27, T30, T40, T45, T50, T55
6x		10x75mm: T20, T25, T30, T40, T45, T50
7x		10x30mm: T20, T25, T30, T40, T45, T50, T55
9x		1/4"x25mm: T8, T9, T10, T15, T20, T25, T27, T30, T40
1x		1/4"x1/4"
1x		1/2"x10mm
3x		T60x25mm, T70x65mm, T50x100mm
5x		E4, E5, E6, E7, E8

REF			
8575	385x170mm	1,45kg	10x

Módulo 5 limas
Módulo 5 limas



1x	8"	
1x	8"	
1x	8"	
1x	8"	
1x	8"	

REF			
8521	385x170mm	950gr	10x

Módulo 6 peças martelo de pena e nylon com saca troços
Módulo 6 piezas martillo pluma y nylon con botadores



1x		500gr
1x		40mm
4x		3x150mm, 4x150mm, 5x150mm, 6x150mm

REF			
8592	385x170mm	1,65kg	10x

Módulo 9 peças punções e saca cavilhas
Módulo 9 piezas botadores conicos y cilindricos

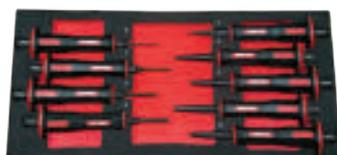

1x		6mm
4x		2mm, 3mm, 4mm, 5mm
4x		2mm, 3mm, 4mm, 5mm

REF			
8574	385x170mm	1,13kg	10x

 Módulo 2 martelos

 Módulo 2 martillos

Módulo vazio / Módulo vacío



REF 8522V

1x		500gr
1x		40mm

REF

8522



385x170mm



1,42kg



10x

 Módulo 7 ferramentas de medição

 Módulo 7 herramientas de medición

Módulo vazio / Módulo vacío



REF 8528V

1x		300mm / 12"
1x		
1x		0.05, 0.06, 0.07, 0.08, 0.09, 0.10 0.15, 0.20, 0.25, 0.30, 0.35, 0.40, 0.75, 1.00
1x		3m
1x		150mm
1x		
1x		

REF

8528



385x170mm



770gr



10x

 Módulo 12 compartimentos de arrumação

 Módulo 12 compartimientos de arrumación

 **Composição:**
 (6x) Compartimentos 20x45x95mm
 (6x) Compartimentos 20x45x70mm

 **Composición:**
 (6x) Compartimientos 20x45x95mm
 (6x) Compartimientos 20x45x70mm

REF

8537



385x170mm



100gr



10x

 Módulo 7 peças, chaves inglesas, agrafador, x-ato

 Módulo 7 piezas, llaves inglesas, grapadora, cutter

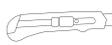
1x		
1x		
2x		160mm, 210mm
1x		x500UN
1x		x500UN
1x		x500UN

REF

8571



385x170mm



1,21kg



10x

 Módulo 11 chaves de cachimbo hexagonais 8-19mm
 Módulo 11 llaves de pipa hexagonales 8-19mm

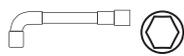

11x		8mm, 10mm, 11mm, 12mm, 13mm, 14mm, 15mm, 16mm, 17mm, 18mm, 19mm
-----	--	---

REF			
8572	385x170mm	2,5kg	5x

 Módulo 7 peças chave hexagonal tubular
 Módulo 7 piezas llave hexagonal tubo

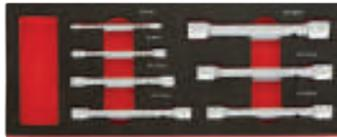

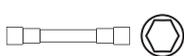
7x		6-7x104mm, 8-9x110mm, 10-11x118mm, 12-13x138mm, 14-15x145mm, 16-17x155mm, 18-19x164mm
----	--	---

REF			
8598	385x170mm	1,3kg	1x

 Módulo 6 chaves de travão 6-24mm
 Módulo 6 llaves de freno 6-24mm

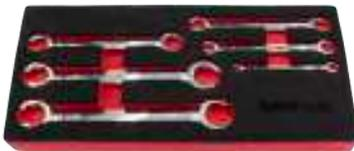

Módulo vazio / Módulo vacío



REF 8517V

6x		6-8mm, 10-12mm, 13-14mm, 15-17mm, 19-21mm, 22-24mm
----	--	--

REF			
8517	385x170mm	800gr	10x

 Módulo 6 chaves articuladas 8-19mm
 Módulo 6 llaves articuladas 8-19mm



Módulo vazio / Módulo vacío



REF 8606V

6x		8-9x200mm, 10-11x215mm, 12-13x235mm, 14-15x245mm, 16-17x260mm, 18-19x275mm
----	--	--

REF			
8606	385x170mm	1,5kg	10x

-  Módulo 8 chaves de luneta 6-22mm
 Módulo 8 llaves de estrella 6-22mm



Módulo vazio / Módulo vacío



REF 8524V

8x		6-7mm, 8-9mm, 10-11mm, 12-13mm, 14-15mm, 16-17mm, 18-19mm, 20-22mm
----	--	--

REF			
8524	385x170mm	1,3kg	1x

-  Módulo 17 chaves boca luneta 6-22mm
 Módulo 17 llaves combinadas 6-22mm



Módulo vazio / Módulo vacío



REF 8518V

17x		6mm, 7mm, 8mm, 9mm, 10mm, 11mm, 12mm, 13mm, 14mm, 15mm, 16mm, 17mm, 18mm, 19mm, 20mm, 21mm, 22mm
-----	--	--

REF			
8518	385x170mm	1,9kg	1x

-  Módulo 5 chaves luneta curva 8-22mm
 Módulo 5 llaves estrella media luna 8-22mm



5x		8-10x125mm, 11-13x145mm, 14-15x170mm, 17-19x190mm, 20-22x225mm
----	--	--

REF			
8596	385x170mm	1,3kg	10x

-  Módulo 4 chaves de luneta 21-32mm
 Módulo 4 llaves estrella acodadas 21-32mm



Módulo vazio / Módulo vacío



REF 8525V

4x		21-23mm, 24-27mm, 25-28mm, 30-32mm
----	--	------------------------------------

REF			
8525	385x170mm	2,15kg	1x

Módulo 6 chaves de luneta em S 8-19mm
Módulo 6 llaves de estrella en S 8-19mm



6x		8-9x125mm, 10-11x140mm, 12-13x160mm, 14-15x190mm, 16-17x225mm, 18-19x235mm
----	--	--

REF			
8594	385x170mm	950gr	10x

Módulo 10 chaves de boca 6-32mm
Módulo 10 llaves fijas 6-32mm



Módulo vazio / Módulo vacío



REF 8526V

10x		6-7mm, 8-9mm, 10-11mm, 12-13mm, 14-15mm, 16-17mm, 18-19mm, 20-22mm, 24-27mm, 30-32mm
-----	--	--

REF			
8526	385x170mm	1,4kg	1x

Módulo 12 chaves boca luneta roquete 8-19mm
Módulo 12 llaves combinadas con carraca 8-19mm



Módulo vazio / Módulo vacío

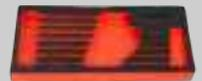

REF 8591V

12x		8x140mm, 9x150mm, 10x160mm, 11x165mm, 12x170mm, 13x180mm, 14x190mm, 15x200mm, 16x205mm, 17x225mm, 18x240mm, 19x250mm
-----	--	--

REF			
8591	385x170mm	1,6kg	10x

Módulo 5 chaves boca luneta 24-32mm
Módulo 5 llaves combinadas estrella 24-32mm



Módulo vazio / Módulo vacío



REF 8527V

5x		24mm, 27mm, 29mm, 30mm, 32mm
----	--	------------------------------

REF			
8527	375x343mm	1,1kg	1x

-  Módulo chaves combinadas c/ roquete flexível 8 pcs
 Módulo llaves combinadas c/ carraca flexible 8 pzs

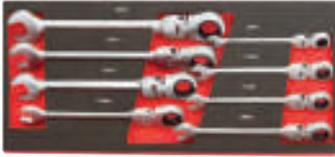

Módulo vazio / Módulo vacío



REF 8597V

8x		8x140mm, 10x160mm, 11x160mm, 13x180mm, 14x190mm, 16x210mm, 18x230mm, 19x250mm
----	--	---

REF			
8597	385x170mm	1,3kg	10x

-  Módulo chaves pé de galo 3/8"+1/2"+3/4" 32 pcs
 Módulo llaves pies de gallo 3/8"+1/2"+3/4" 32 pzs



27x CR-MO		3/8": 10, 11, 12, 13, 14, 15, 16, 17, 18, 19mm
		1/2": 20, 21, 22, 23, 24, 25, 26, 27, 28, 30, 32, 33, 36mm
		3/4": 38, 41, 46, 50mm
1x		1/2" (F/H) para 3/8" (M)
1x		1/2" (F/H) para 3/4" (M)
1x		125mm x 1/2"
1x		100mm x 3/4"
1x		375mm 1/2"

REF			
8568	520x390mm	6kg	2x

-  Módulo chaves boca roquete e bits 1/4"
 Módulo llaves combinadas con carraca y puntas 1/4"



13x		8, 9, 10, 11, 12, 13, 14, 15, 16, 17, 19, 21, 22mm
9x		1.5, 2, 2.5, 3, 4, 5, 6, 8, 10mm
23x		T8, T10, T15, T20, T25, T30, T40
		3, 4, 5, 6, 7, 8mm
		PH1, PH2, PH3
		PZ1, PZ2, PZ3
		SL3, SL4, SL5, SL6

REF			
8569	545x425mm	2,95kg	2x

 **Kit módulos 236 peças para 6 gavetas**
 **Kit módulos 236 piezas para 6 cajones**

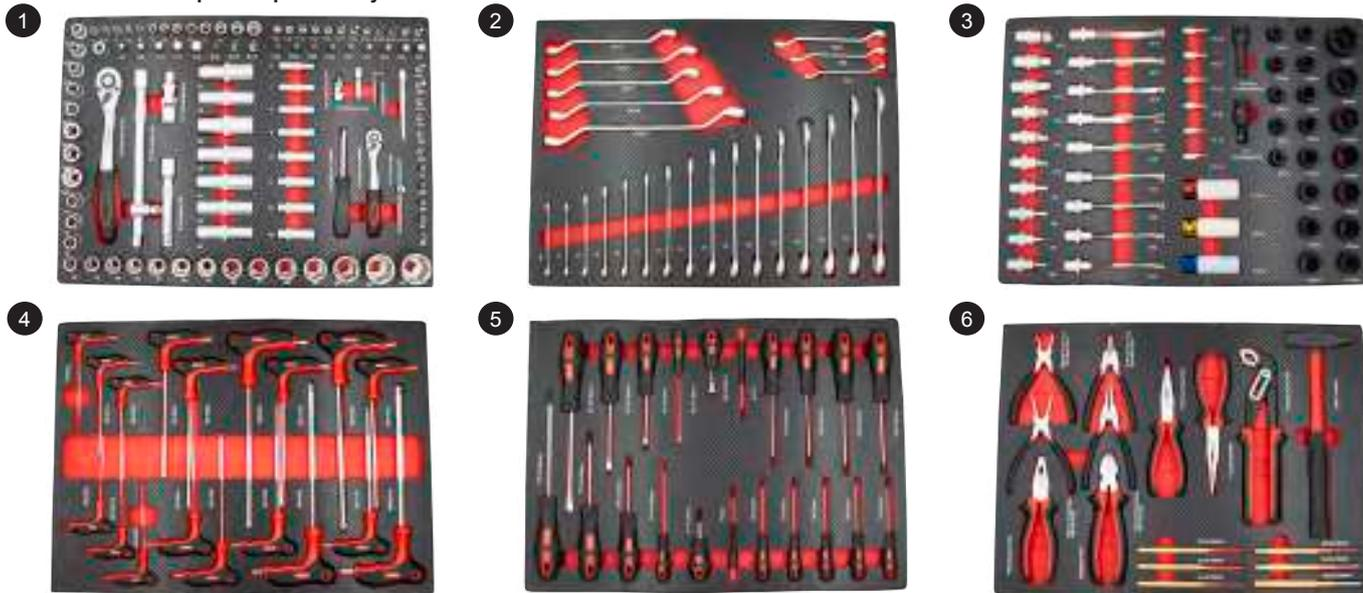

-  
- (2x) Roquetes/Carracas: 1/2", 1/4" (40CR+CRMO)
 - (4x) Aumentos/Alargaderas: 1/4" (100mm, 50mm), 1/2"(125mm, 250mm) (CRV)
 - (2x) Cardans/Articulaciones: 1/2", 1/4" (CRV)
 - (1x) Adaptador: 3/8" fêmea para 1/2" macho/3/8" hembra a 1/2" macho (CRV)
 - (1x) Corrediço/Corredizo: 1/4" (CRV)
 - (1x) Adaptador: 1/4" (aço carbono/acero al carbono)
 - (3x) Chave/Llaves hexagonal: 1.5,2,2.5mm (aço carbono/acero al carbono)
 - (13x) Chaves caixa/Llaves de vaso 1/4": 4,4.5,5,5.5,6,7,8,9,10,11,12,13,14mm (CRV)
 - (17x) Chaves caixa/Llaves de vaso 1/2": 10,11,12,13,14,15,16,17,18,19, 20,21,22,24,27,30,32mm (CRV)
 - (8x) Chaves caixa longa/Llaves de vaso largas: 1/4": 6,7,8,9,10,11,12,13mm (CRV)
 - (7x) Chaves caixa longa/Llaves de vaso largas 1/2": 14,15,16,17,19, 21,22mm (CRV)
 - (1x) Adaptador 1/2"
 - (5x) Chaves caixa Torx interior/Llaves de vaso torx interior 1/4": E4, E5, E6, E7, E8
 - (8x) Chaves caixa Torx interior/Llaves de vaso torx interior 1/2": E10, E11, E12, E14, E16, E18, E20, E24
 - (17x) Bits/Puntas: H7, H8, H10, H12, H14, SL8, SL10, SL12, PH3,PH4,PZ3, PZ4, T40,T45,T50,T55,T60
 - (18x) Chaves de caixa com bit/Llaves de vaso con punta: T30, T27, T25, T20, T15, T10, T8, SL4, SL5.5, SL6.5, HW3, HW4, HW5, HW6, PH1, PH2, PZ1, PZ2
 - (16x) Chaves combinadas/Llaves combinadas: 6,7,8,9,10,11,12,13,14,15,16,17,18,19,21,22mm (aço carbono/carbono acero)
 - (8x) Chaves luneta/Llaves acodadas: 6*7-8*9-10*11-12*13-14*15-16*17-18*19-20*22mm (aço carbono/carbono acero)
 - (20x) Chaves de caixa impacto/Llaves de impacto de 1/2": 8,9,10,11,12,13,14,15,16,17,18,19,20,21,22,23,24,27,30,32mm (CRV)
 - (1x) Cardan universal impacto/Articulacion impacto de 1/2" (CRV)
 - (1x) Aumento impacto/Alargadera impacto 1/2" 75mm (CRV)
 - (3x) Chaves de impacto 1/2"(com revestimento)/Llaves de impacto 1/2" (con revestimiento): 17,19,21mm (CRV)
 - (6x) Bits/Puntas 1/4": T10, T15, T20, T25, T27, T30 (CRV)
 - (10x) Chaves de caixa 1/2"com bit/Llaves de vaso de 1/2" con puntas: H6, H7, H8, H9, H10, H12, H14, H17, H19, H22, Comprimento/Longitud: 55mm (CRV)
 - (9x) Chaves de caixa 1/2"com bit longo/Llaves de vaso de 1/2" con punta larga: T40-T45-T50-T55-T60-T70-M10-M12-M14, Comprimento/Longitud:139mm (CRV)
 - (18x) Chaves em T/Llaves en T: 2*100,2.5*100,3*100, 4*150,5*150,6*150,7*150, 8*200, 10*200mm; T10*75, T15*100,T20*100,T25*150,T27*150, T30*150, T40*150, T45*200,T50*200mm
 - (19x) Chaves de punho/Destornilladores: PH0*100,PH1*75, PH2*100, PH2*38,PH3*150, SL3*100, SL5*75, SL6*100, SL6*38, SL8*150,T6*75,T7*75,T8*75, T9*75,T10*75,T15*100, T20*100-T25*100, T30*100 (CRV)
 - (2x) Chaves de punho/Destornilladores: SL2,PH0 (CRV)
 - (1x) Alicata de bomba de água/agua 250mm (aço carbono/acero al carbono)
 - (1x) Martelo mecânico/Martillo mecánico 300gr (aço carbono/acero al carbono)
 - (1x) Alicata universal 175mm (aço carbono/acero al carbono)
 - (1x) Alicata pontas longas curvo/de punta larga curvada 200mm (aço carbono/acero al carbono)
 - (1x) Alicata pontas/de punta larga 200mm (aço carbono/acero al carbono)
 - (1x) Alicata corte 175mm (aço carbono/acero al carbono)
 - (4x) Alicata freios fechar curvo / alicata freios abrir curvo / alicata freios abrir reto / alicata freios fechar reto/ Alicates puntas interior curvo / alicata puntas exterior curvo / alicata puntas interior recto / alicata puntas interior curvo 150mm (aço carbono/acero al carbono)
 - (6x) Punções cilíndricas/Punzones cilindros 3*150-4*150-5*150-6*150-8*150-10*150mm (CRV)

REF

86236



21kg



1x

 Conjunto 6 módulos ferramenta isolada
 Juego de 6 módulos de herramientas aisladas



1000V
IEC 60900

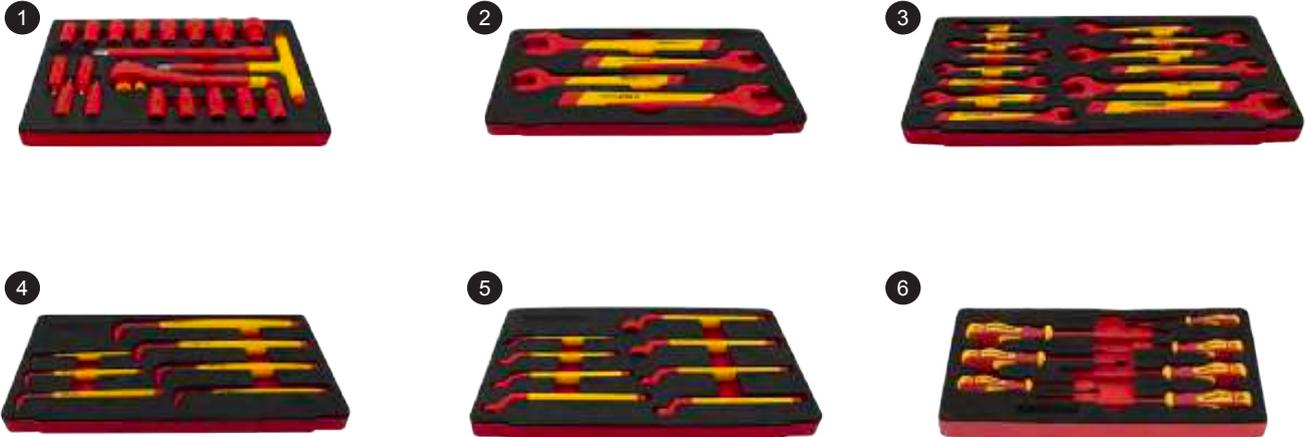

1			
13x			10mm, 11mm, 12mm, 13mm, 14mm, 16mm, 17mm, 18mm, 19mm, 21mm, 22mm, 24mm, 27mm
4x			H4*80mm, H5*80mm, H6*80mm, H8*80mm
1x			1/2": 75mm, 125mm
1x			1/2": 200mm
1x			1/2": 250mm
2			
4x			24mm, 27mm, 30mm, 32mm
3			
14x			6mm, 7mm, 8mm, 9mm, 10mm, 11mm, 12mm, 13mm, 14mm, 15mm, 16mm, 17mm, 19mm, 21mm
4			
7x			3mm, 4mm, 5mm, 6mm, 8mm, 10mm, 12mm
5			
8x			7mm, 8mm, 10mm, 12mm, 13mm, 14mm, 17mm, 19mm
6			
3x			PH1x80mm, PH2x100mm, PH3x150mm
4x			SL3x75mm, SL4x100mm, SL5.5x125mm, SL6.5x150mm

- Carro de ferramenta isolada - 6 módulos
- Carro con herramienta aislada - 6 módulos

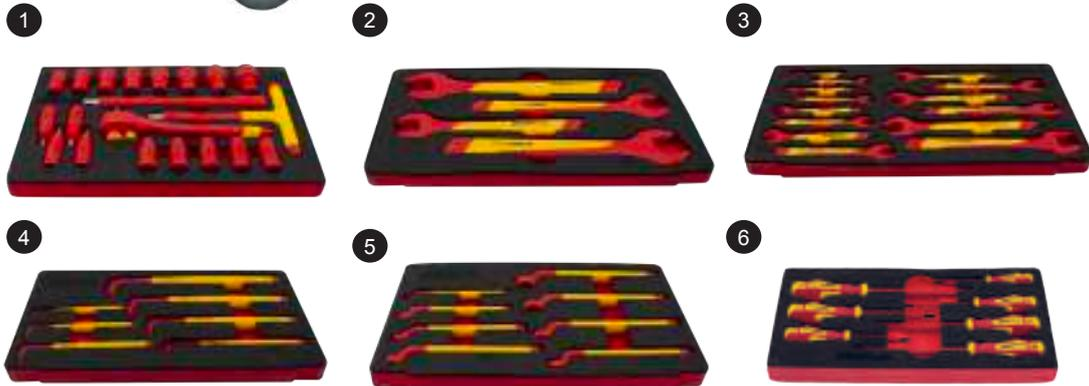
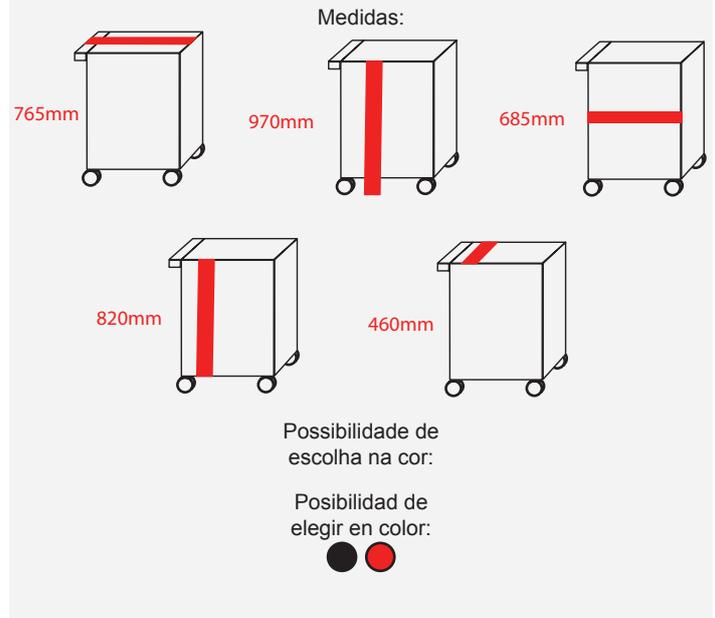

1	13x		10mm, 11mm, 12mm, 13mm, 14mm, 16mm, 17mm, 18mm, 19mm, 21mm, 22mm, 24mm, 27mm
	4x		H4*80mm, H5*80mm, H6*80mm, H8*80mm
	1x		1/2": 75mm, 125mm
	1x		1/2": 200mm
	1x		1/2": 250mm

4	7x		3mm, 4mm, 5mm, 6mm, 8mm, 10mm, 12mm
---	----	--	-------------------------------------

5	8x		7mm, 8mm, 10mm, 12mm, 13mm, 14mm, 17mm, 19mm
---	----	--	--

6	3x		PH1x80mm, PH2x100mm, PH3x150mm
	4x		SL3x75mm, SL4x100mm, SL5.5x125mm, SL6.5x150mm

2	4x		24mm, 27mm, 30mm, 32mm
---	----	--	------------------------

3	14x		6mm, 7mm, 8mm, 9mm, 10mm, 11mm, 12mm, 13mm, 14mm, 15mm, 16mm, 17mm, 19mm, 21mm
---	-----	--	--

Dimensões gavetas:
(5x) 530x400x65mm, (2x) 530x400x145mm

Dimensiones cajones:
(5x) 530x400x65mm, (2x) 530x400x145mm

REF	Cor / Color		
8498PRE	Preto / Negro	60,23kg	1x
8498VER	Vermelho / Rojo	60,23kg	1x

 Carro de ferramentas 7 gavetas 173 peças
 Carro de herramientas 7 cajones 173 piezas

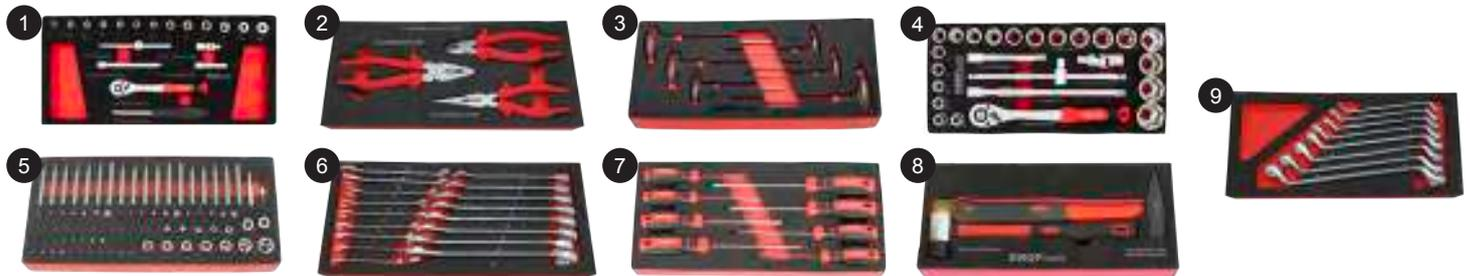
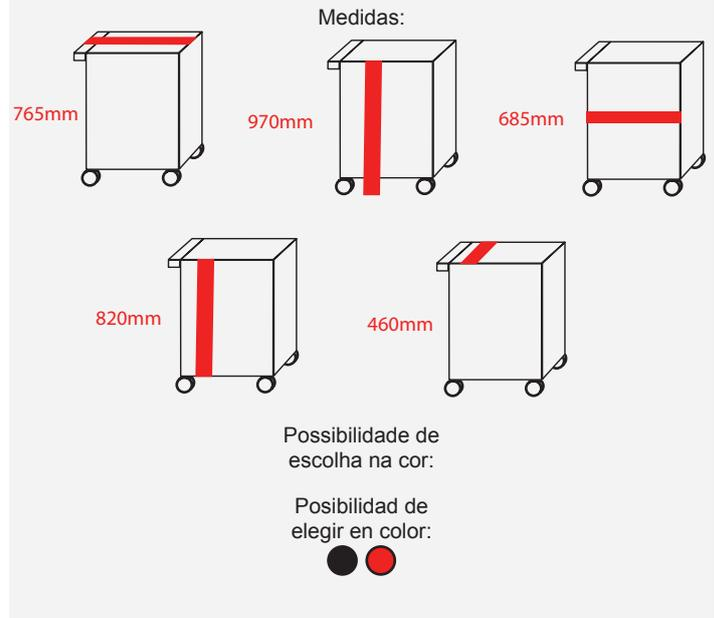

Módulo	Referência	Quantidade	Descrição
1	8511	19x	Chaves caixa 1/4"
2	8512	3x	Alicates
3	8514	6x	Chaves T umbrako
4	8515	25x	Chaves caixa 1/2" e roquete
5	8516	85x	Bits
6	8518	17x	Boca luneta 6-22mm
7	8520	8x	Chaves fenda e cruz
8	8522	2x	Martelos
9	8524	8x	Chaves luneta curva 6-22mm

Módulo	Referencia	Cantidad	Descripción
1	8511	19x	Llaves vaso 1/4"
2	8512	3x	Alicates
3	8514	6x	Llaves T umbrako
4	8515	25x	Llaves vaso 1/2" y carraca
5	8516	85x	Puntas
6	8518	17x	Llaves combinadas 6-22mm
7	8520	8x	Destornilladores planos y phillips
8	8522	2x	Martillos
9	8524	8x	Llaves estrella 6-22mm

 **Dimensões gavetas:**
 (5x) 530x400x65mm, (2x) 530x400x145mm

 **Dimensiones cajones:**
 (5x) 530x400x65mm, (2x) 530x400x145mm

REF	Cor / Color		
8501PRE	Preto / Negro	63,51kg	1x
8501VER	Vermelho / Rojo	63,51kg	1x

 Carro de ferramentas 7 gavetas 236 peças
 Carro de herramientas 7 cajones 236 piezas

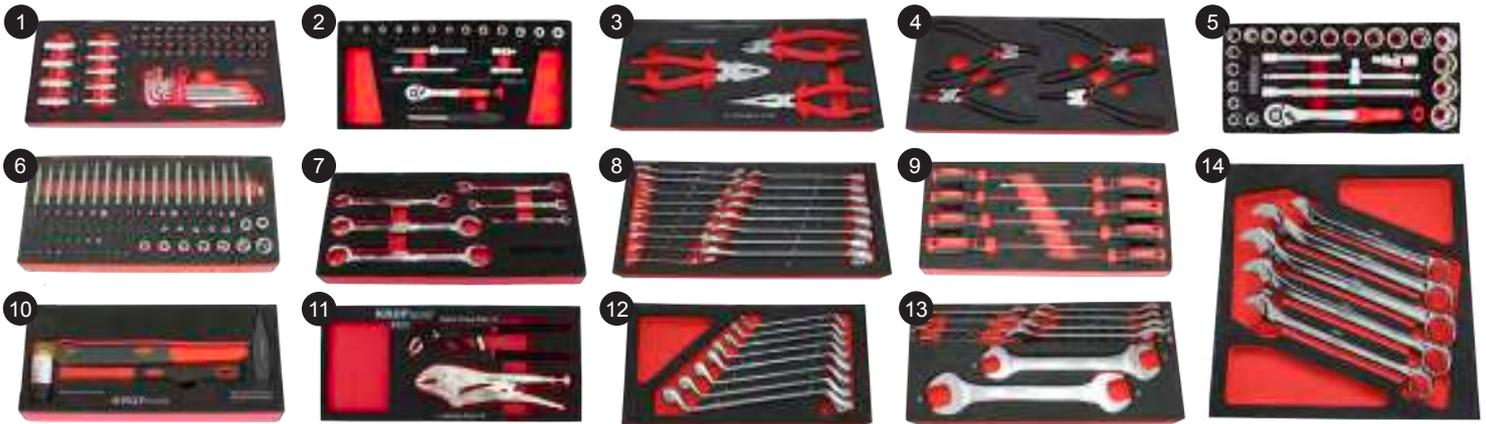
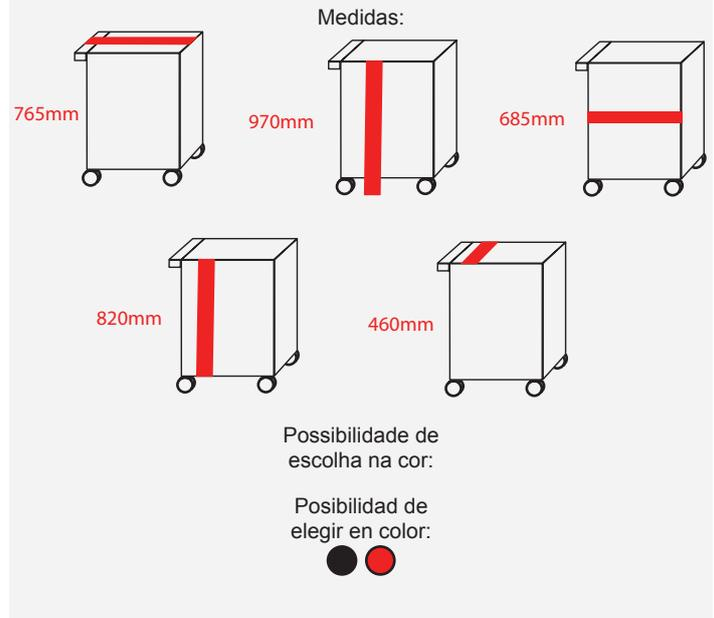

Módulo	Referência	Quantidade	Descrição
1	8510	42x	Chaves de caixa 1/4"
2	8511	19x	Chaves de caixa 1/4"
3	8512	3x	Alicates
4	8513	4x	Alicates de freios
5	8515	25x	Ch. de caixa 1/2" e roquete
6	8516	85x	Bits
7	8517	6x	Chaves de travão 6~24mm
8	8518	17x	Boca luneta 6~22mm
9	8520	8x	Chaves de fenda e cruz
10	8522	2x	Martelos
11	8523	2x	Alicates
12	8524	8x	Chaves luneta 6-22mm
13	8526	10x	Chaves de boca 6-32mm
14	8527	5x	Ch. boca luneta 24-32mm

Módulo	Referencia	Cantidad	Descripción
1	8510	42x	Llaves de vaso de 1/4"
2	8511	19x	Llaves de vaso de 1/4"
3	8512	3x	Alicates
4	8513	4x	Alicates de arandelas
5	8515	25x	Ll. vaso de 1/2" y carraca
6	8516	85x	Puntas
7	8517	6x	Ll. de freno 6-24mm
8	8518	17x	Ll. combinadas 6-22mm
9	8520	8x	Destornill. planos y phillips
10	8522	2x	Martillos
11	8523	2x	Alicates
12	8524	8x	Llaves estrella 6-22mm
13	8526	10x	Llaves combinadas 6-32mm
14	8527	5x	Lla. combinadas 24-32mm

 Dimensões gavetas:
(5x) 530x400x65mm, (2x) 530x400x145mm

 Dimensiones cajones:
(5x) 530x400x65mm, (2x) 530x400x145mm

REF	Cor / Color		
8500PRE	Preto / Negro	68,90kg	1x
8500VER	Vermelho / Rojo	68,90kg	1x

 Carro de ferramentas 7 gavetas 267 peças
 Carro de herramientas 7 cajones 267 piezas

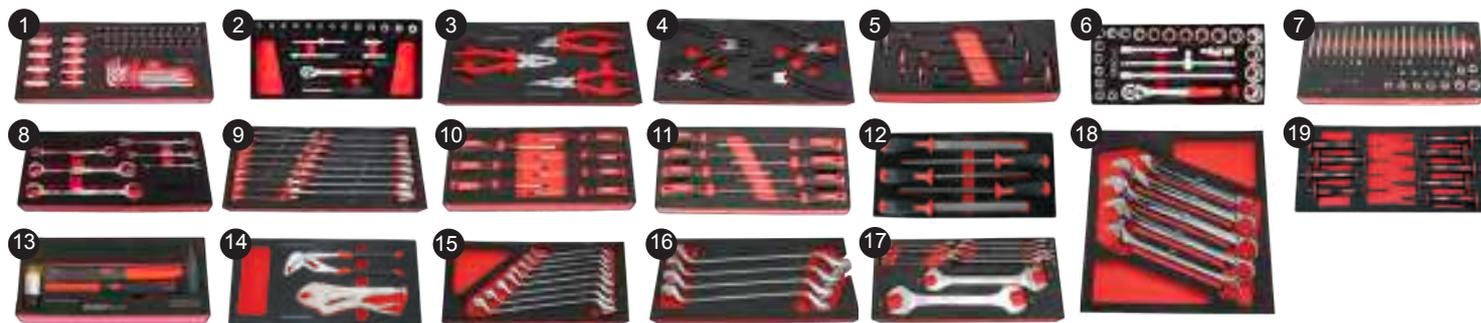
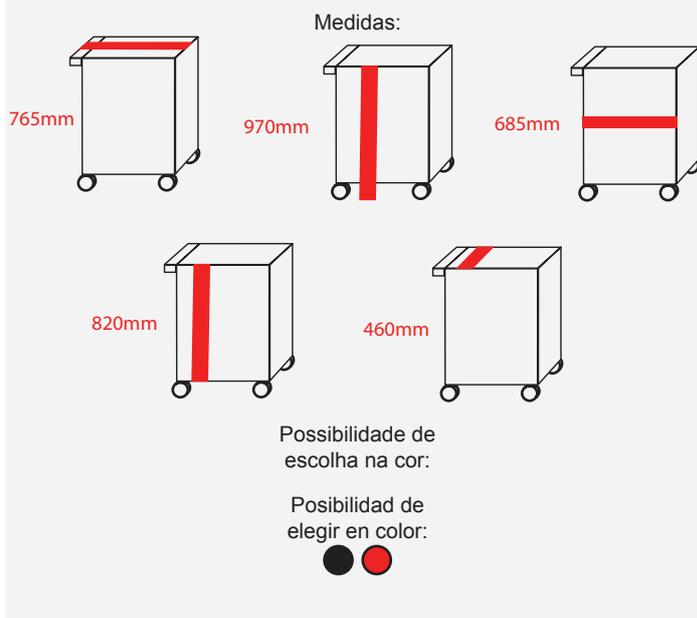

Módulo	Referência	Quantidade	Descrição
1	8510	42x	Chaves caixa 1/4"
2	8511	19x	Chaves caixa 1/4"
3	8512	3x	Alicates
4	8513	4x	Alicates de freios
5	8514	6x	Chaves T umbrako
6	8515	25x	Chaves caixa 1/2" e roquetes
7	8516	85x	Bits
8	8517	6x	Chaves de travão 6-24mm
9	8518	17x	Chaves boca luneta 6-22mm
10	8519	7x	Chaves torx T10-T40
11	8520	8x	Chaves fenda e cruz
12	8521	5x	Limas
13	8522	2x	Martelos
14	8523	2x	Alicates
15	8524	8x	Chaves luneta 6-22mm
16	8525	4x	Chaves luneta 21-32mm
17	8526	10x	Chaves boca 6-32mm
18	8527	5x	Ch. boca luneta 24-32mm
19	8574	9x	Punções e saca cavilhas

Módulo	Referencia	Cantidad	Descripción
1	8510	42x	Llaves vaso 1/4"
2	8511	19x	Llaves vaso 1/4"
3	8512	3x	Alicates
4	8513	4x	Alicates arandelas
5	8514	6x	Llaves umbrako
6	8515	25x	Llaves de vaso 1/2" y carraca
7	8516	85x	Puntas
8	8517	6x	Llaves de frenos
9	8518	17x	Llaves combinadas
10	8519	7x	Destornilladores Torx
11	8520	8x	Destor Planos y Phillips
12	8521	5x	Limas
13	8522	2x	Martillos
14	8523	2x	Alicates
15	8524	8x	Llaves acodadas 6-22mm
16	8525	4x	Llaves acodadas 21-32mm
17	8526	10x	Llaves boca 6-32mm
18	8527	5x	Llaves combinadas 24-32mm
19	8574	9x	Botadores

 **Dimensões gavetas:**
 (5x) 530x400x65mm, (2x) 530x400x145mm

 **Dimensiones cajones:**
 (5x) 530x400x65mm, (2x) 530x400x145mm

REF	Cor / Color		
8502VER	Vermelho / Rojo	74,32kg	1x
8502PRE	Preto / Negro	74,32kg	1x

 Carro ferramenta 7 gavetas 352 peças
 Carro herramientas 7 cajones 352 piezas

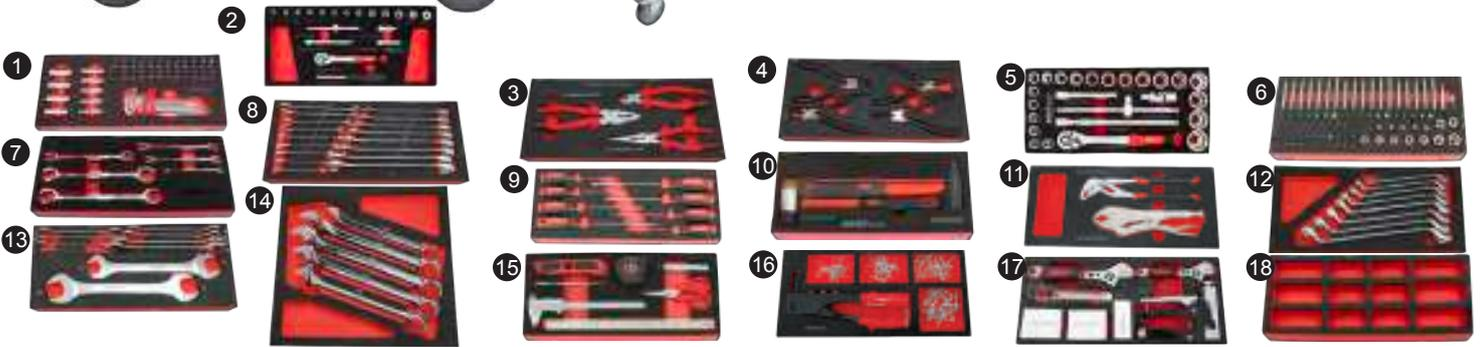
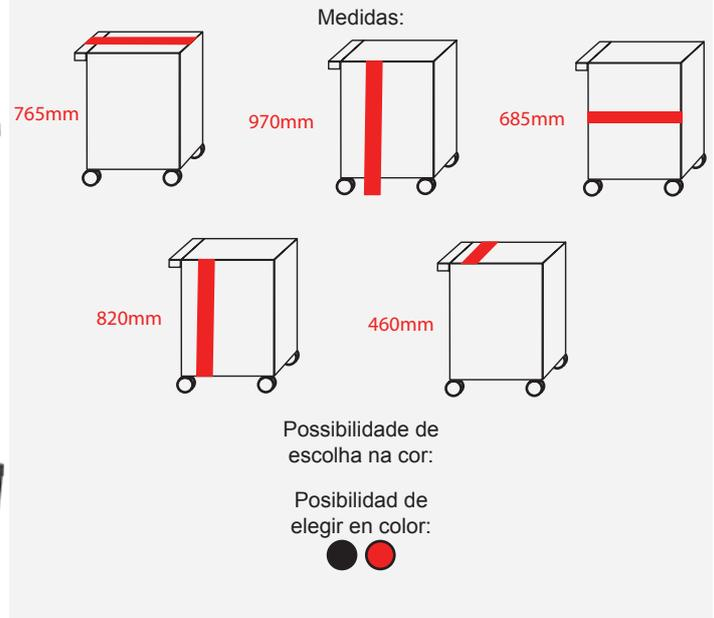

Módulo	Referência	Quantidade	Descrição
1	8510	42x	Chaves caixa 1/4"
2	8511	19x	Chaves caixa 1/4"
3	8512	3x	Alicates
4	8513	4x	Alicates freios
5	8515	25x	Chaves caixa e roquete 1/2"
6	8516	85x	Bits
7	8517	6x	Chaves travão 6-24mm
8	8518	17x	Chaves boca luneta 6-22mm
9	8520	8x	Chaves fenda e cruz
10	8522	2x	Martelos
11	8523	2x	Alicates
12	8524	8x	Chaves luneta 6-22mm
13	8526	10x	Chaves boca 6-32mm
14	8527	5x	Chaves boca luneta 24-32mm
15	8528	7x	Ferramentas medição
16	8529	101x	Alicate de rebites e rebites
17	8571	7x	Chaves inglesa e agrafador e x-ato
18	8537	1x	12 Compartimentos arrumação

Módulo	Referencia	Cantidad	Descripción
1	8510	42x	Llaves vaso 1/4"
2	8511	19x	Llaves vaso 1/4"
3	8512	3x	Alicates
4	8513	4x	Alicates arandelas
5	8515	25x	Llaves vaso y carraca 1/2"
6	8516	85x	Puntas
7	8517	6x	Llaves de freno
8	8518	17x	Llaves combinadas 6-22mm
9	8520	8x	Destornilladores planos y phillips
10	8522	2x	Martillos
11	8523	2x	Alicates
12	8524	8x	Llaves estrella 6-22mm
13	8526	10x	Llaves bocas 6-32mm
14	8527	5x	Llaves combinadas 24-32mm
15	8528	7x	Herramientas medición
16	8529	101x	Remachadora y remaches
17	8571	7x	Grapadora, llaves inglesas y cutter
18	8537	1x	12 Compartimentos arrumación

 Dimensões gavetas:
(5x) 530x400x65mm, (2x) 530x400x145mm

 Dimensiones cajones:
(5x) 530x400x65mm, (2x) 530x400x145mm

REF	Cor / Color		
8353VER	Vermelho / Rojo	72,36kg	1x
8353PRE	Preto / Negro	72,36kg	1x

 Carro de ferramentas 7 gavetas 160 peças
 Carro de herramientas 7 cajones 160 piezas



Medidas:

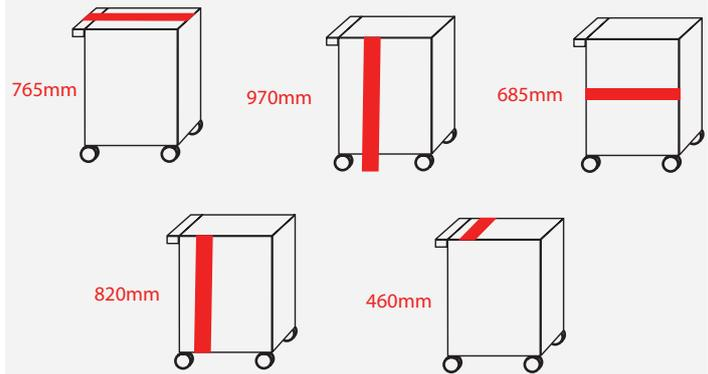

Possibilidade de escolha na cor:

Possibilidade de elegir en color:



1



2



3



4



5



Módulo	Quantidade	Descrição
1	68x	Chaves de caixa e roquete 1/4", 3/8", 1/2"
2	35x	Chaves boca luneta, luneta e bocas
3	34x	Chaves fenda e cruz electricista
4	9x	Alicates
5	14x	Martelos e chaves T umbrako e torx

Módulo	Cantidad	Descripción
1	68x	Llaves de vaso y carraca 1/4", 3/8", 1/2"
2	35x	Llaves combinadas, estrella y bocas
3	34x	Llaves planas y phillips electricista
4	9x	Alicates
5	14x	Martillos y llaves T umbrako y torx

 **Dimensões gavetas:**
 (5x) 554x58x410mm
 (1x) 554x128x410mm
 (1x) 554x196x410mm

 **Dimensiones cajones:**
 (5x) 554x58x410mm
 (1x) 554x128x410mm
 (1x) 554x196x410mm

REF

8612



65kg



1x

 Carro ferramenta 14 gavetas 353 peças
 Carro herramientas 14 cajones 353 piezas

Medidas:

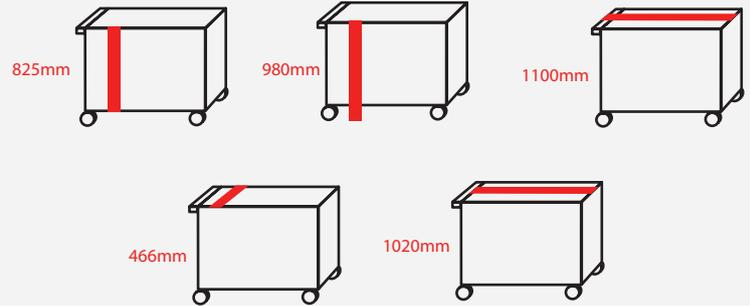

Módulos	Referência	Quantidade	Descrição
1	8511	19x	Chave caixa 1/4"
2	8512	3x	Alicates
3	8513	4x	Alicates de freios
4	8514	6x	Chaves T umbrako
5	8515	25x	Chaves caixa 1/2" e roquete
6	8516	85x	Bits
7	8517	6x	Chaves travão
8	8518	17x	Chaves boca luneta
9	8519	7x	Torx com punho T10-T40
10	8520	8x	Fenda e cruz
11	8522	2x	Martelos
12	8523	2x	Alicates
13	8524	8x	Chaves luneta 6-22mm
14	8525	4x	Chaves luneta 21-32mm
15	8526	10x	Chaves bocas 6-32mm
16	8528	7x	Ferramenta medição
17	8529	101x	Alicate de rebites e rebites
18	8537	-	Compartimentos de arrumação
19	8571	7x	Ch. inglesas, agrafador e x-ato
20	8572	11x	Chaves de cachimbo 8-19mm
21	8573	20x	Chave de caixa 3/8" 8-24mm

Módulos	Referencia	Cantidad	Descripción
1	8511	19x	Llaves vaso 1/4"
2	8512	3x	Alicates
3	8513	4x	Alicates de arandelas
4	8514	6x	Llaves T umbrako
5	8515	25x	Llaves vaso 1/2" y carraca
6	8516	85x	Puntas
7	8517	6x	Llaves freno 6-24mm
8	8518	17x	Llaves combinadas
9	8519	7x	Destornilladores torx T10-T40
10	8520	8x	Desornilladores planos y phillips
11	8522	2x	Martillos
12	8523	2x	Alicates
13	8524	8x	Llaves estrella 6-22mm
14	8525	4x	Llaves estrella 21-32mm
15	8526	10x	Llaves bocas 6-32mm
16	8528	7x	Herramienta medición
17	8529	101x	Remachadora y remaches
18	8537	-	Compartimentos de arrumación
19	8571	7x	Llaves ajust., grapadora, cutter
20	8572	11x	Llaves pipa 8-19mm
21	8573	20x	Llaves de vaso 3/8" 8-24mm

 **Dimensões gavetas:**
Grandes: (5x) 560x395x65mm, (2x) 560x395x145mm
Pequenas: (5x) 250x395x65mm, (2x) 250x395x145mm

 **Dimensiones cajones:**
Grandes: (5x) 560x395x65mm, (2x) 560x395x145mm
Pequeños: (5x) 250x395x65mm, (2x) 250x395x145mm

REF

8354



116,12kg



1x

Armário 2 portas com 3 prateleiras

Armario 2 puertas con 3 estantes



Características:
 Espessura: 0,7-0,8mm
 Prateleira: 3 unidades
 Pés ajustáveis: 40mm
 Medidas: 660mm (Comprimento) x 457mm (Largura) x 1981mm (Altura)

Características:
 Espesor: 0,7-0,8mm
 Estante: 3 uni
 Pies ajustables: 40mm
 Medidas: 660mm (Largo) x 457mm (Ancho) x 1981mm (Alto)

REF

8801



42,05kg



1x

Módulo fixo 5 gavetas

Cajonera fijo con 5 cajones



Características:
 Espessura: 0,7-0,8mm; Pés ajustáveis: 40mm
 Medidas: 660mm (Comprimento) x 457mm (Largura) x 864mm (Altura)
 Pé ajustável: 80mm (Altura)

Características:
 Espesor: 0,7-0,8mm; Pies ajustables: 40mm
 Medidas: 660mm (Largo) x 457mm (Ancho), 864mm (Alto)
 Pies ajustables: 80mm (Alto)

REF

8802



35,6kg



1x

Módulo fixo 2 portas com 1 prateleira

Modulo fijo con 2 puertas con 1 estante



Características:
 Espessura: 0,7-0,8mm
 Prateleira: 1 unidade
 Pés ajustáveis: 40mm
 Medidas: 660mm (Comprimento) x 457mm (Largura) x 864mm (Altura)

Características:
 Espesor: 0,7-0,8 mm
 Estante: 1 Unidad
 Pies ajustables: 40mm
 Medidas: 660mm (Largo) x 457mm (Ancho) x 864mm (Alto)

REF

8803



20,35kg



1x

Módulo carro com 4 gavetas

Cajonera móvil con 4 cajones



Características:
 Espessura: 0,7-0,8mm
 Rodas: 100mm
 Medidas: 610mm (Comprimento) x 432mm (Largura) x 838mm (Altura)

Características:
 Espesor: 0,7-0,8mm
 Ruedas: 100mm
 Medidas: 610mm (Largo) x 432mm (Ancho) x 838mm (Altura)

REF

8804



35kg



1x

 **Módulo fixo para papel e lixo**
 **Modulo fijo porta-papel**



 **Características:**
Espessura: 0,7-0,8mm
Pés ajustáveis: 40mm
Medidas: 660mm (Comprimento) x 457mm (Largura) x 864mm (Altura)

 **Características:**
Espesor: 0,7-0,8mm
Pies ajustables: 40mm
Medidas: 660mm (Largo) x 457mm (Ancho) x 864mm (Alto)

REF		
8805	27,5kg	1x

 **Módulo fixo parede 2 portas**
 **Armario alto 2 puertas**



 **Características:**
Espessura: 0,7-0,8mm
Medidas: 660mm (Comprimento) x 305mm (Largura) x 406mm (Altura)

 **Características:**
Espesor: 0,7-0,8 mm
Medidas: 660mm (Largo) x 305mm (Ancho) x 406mm (Alto)

REF		
8806	8,9kg	1x

 **Painel perfurado para 1 módulo**
 **Panel perforado para 1 modulo**



 **Características:**
Espessura: 1,0mm
Tamanho malha: 10x10mm
Medidas: 660mm (Comprimento) x 684mm (Largura) x 20mm (Altura)

 **Características:**
Espesor: 1,0mm
Tamaño malla: 10x10mm
Medidas: 660mm (Largo) x 684mm (Ancho) x 20mm (Alto)

REF		
8807	2,95kg	1x

 **Painel Madeira para 2 módulos**
 **Encimera para 2 modulos**



 **Características:**
Espessura: 30mm
Material: Madeira
Medidas: 1320mm (Comprimento) x 457mm (Largura) x 25mm (Altura)
Nota: Compatível com os módulos Ref: 8802 / 8803 / 8804 / 8805

 **Características:**
Espesor: 30mm
Material: Madera
Medidas: 1320mm (Largo) x 457mm (Ancho) x 25mm (Alto)
Nota: Compatible con los módulos Ref: 8802 / 8803 / 8804 / 8805

REF		
8808	10,5kg	1x

-  Painel aço inoxidável para 2 módulos
 Encimera acero inoxidable para 2 modulos



-  **Características:**
 Espessura: 30mm
 Material: Aço inoxidável
 Medidas: 1320mm (Comprimento) x 457mm (Largura) x 25mm (Altura)
Nota: Compatível com os módulos Ref: 8802 / 8803 / 8804 / 8805

-  **Características:**
 Espesor: 30mm
 Material: Acero inoxidable
 Medidas: 1320mm (Largo) x 457mm (Ancho) x 25mm (Alto)
Nota: Compatible con los módulos Ref: 8802 / 8803 / 8804 / 8805

REF



8832

10,5kg

1x

-  Painel madeira para 3 módulos
 Encimera para 3 modulos



-  **Características:**
 Espessura: 30mm
 Material: Madeira
 Medidas: 1980mm (Comprimento) x 457mm (Largura) x 25mm (Altura)
Nota: Compatível com os módulos Ref: 8802 / 8803 / 8804 / 8805

-  **Características:**
 Espesor: 30mm
 Material: Madera
 Medidas: 1980mm (Largo) x 457mm (Ancho) x 25mm (Alto)
Nota: Compatible con los módulos Ref: 8802 / 8803 / 8804 / 8805

REF



8809

15,8kg

1x

-  Painel aço inoxidável para 3 módulos
 Encimera acero inoxidable para 3 modulos

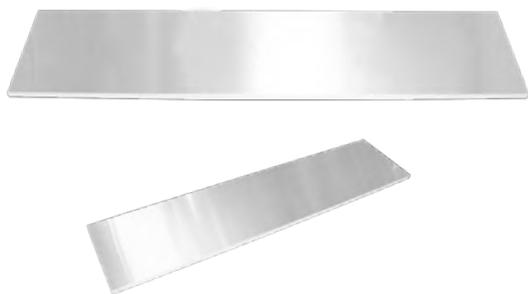

-  **Características:**
 Espessura: 30mm
 Material: Aço inoxidável
 Medidas: 1980mm (Comprimento) x 457mm (Largura) x 25mm (Altura)
Nota: Compatível com os módulos Ref: 8802 / 8803 / 8804 / 8805

-  **Características:**
 Espesor: 30mm
 Material: Acero inoxidable
 Medidas: 1980mm (Largo) x 457mm (Ancho) x 25mm (Alto)
Nota: Compatible con los módulos Ref: 8802 / 8803 / 8804 / 8805

REF



8833

15,8kg

1x

-  Painel madeira para canto
 Encimera para esquina



-  **Características:**
 Espessura: 30mm
 Material: Madeira
 Medidas: 924mm (Comprimento) x 684mm (Largura) x 20mm (Altura)
Nota: Compatível com o Módulo Ref: 8810

-  **Características:**
 Espesor: 30mm
 Material: Madera
 Medidas: 924mm (Largo) x 684mm (Ancho) x 20mm (Alto)
Nota: Compatible con el Modulo Ref: 8810

REF



8813

13kg

1x

 Painel madeira para canto
 Encimera para esquina



 **Características:**
Espessura: 30mm
Material: Aço inoxidável
Medidas: 924mm (Comprimento) x 684mm (Largura) x 20mm (Altura)
Nota: Compatível com o Módulo Ref: 8810

 **Características:**
Espesor: 30mm
Material: Acero inoxidable
Medidas: 924mm (Largo) x 684mm (Ancho) x 20mm (Alto)
Nota: Compatible con el Modulo Ref: 8810

REF		
8834	13kg	1x

 Módulo fixo 2 portas para canto
 Módulo de esquina 2 puertas



 **Características:**
Espessura: 0.7-0.8mm
Pés ajustáveis: 40mm
Medidas: 924mm (Comprimento) x 457mm (Largura) x 864mm (Altura)

 **Características:**
Espesor: 0,7-0,8mm
Pies ajustables: 40mm
Medidas: 924mm (Largo) x 457mm (Ancho) x 864mm (Alto)

REF		
8810	42,3kg	1x

 Módulo fixo parede para canto
 Módulo esquina superior



 **Características:**
Espessura: 0,7-0,8mm
Medidas: 924mm (Comprimento) x 305mm (Largura) x 406mm (Altura)

 **Características:**
Espesor: 0,7-0,8mm
Medidas: 924mm (Largo) x 305mm (Ancho) x 406mm (Alto)

REF		
8811	22,4kg	1x

 Painel perfurado para canto
 Panel perforado para esquina

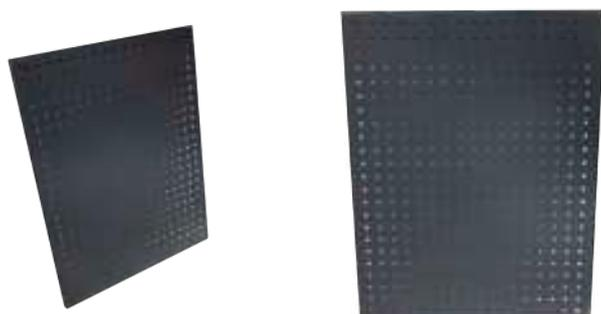

 **Características:**
Espessura: 1.0mm
Tamanho malha: 10x10mm
Medidas: 924mm (Comprimento) x 20mm (Largura) x 684mm (Altura)

 **Características:**
Espesor: 1,0 mm
Tamaño malla: 10x10mm
Medidas: 924mm (Largo) x 20mm (Ancho) x 684mm (Alto)

REF		
8812	5kg	1x

-  Módulo carro com 7 gavetas
 Cajonera móvil con 7 cajones



-  **Características:**
 Espessura: 0,7-0,8mm
 Rodas: Duas rodas com travões e duas sem travões
 Medidas: 610mm (Comprimento) x 432mm (Largura) x 838mm (Altura)

-  **Características:**
 Espesor: 0,7-0,8mm
 Ruedas: Dos ruedas con freno y dos sin freno
 Medidas: 610mm (Largo) x 432mm (Ancho) x 838mm (Alto)

REF

8816



43,7kg



1x

-  Suporte para fixar módulos de canto
 Soporte para modulo esquina



-  **Descrição:**
Nota: Para suportar módulos Ref.: 8811

-  **Descripción:**
Nota: Para soportar (3x) armarios Ref.: 8811

REF

8831



16,9kg



1x

-  Suporte para fixar 2 módulos de parede
 Soporte para 2x armario alto

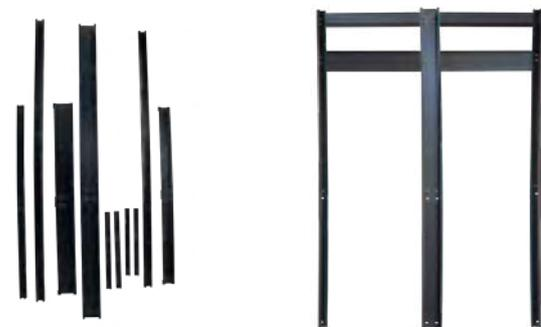

-  **Descrição:**
Nota: Para suportar (2x) módulos Ref.: 8806

-  **Descripción:**
Nota: Para soportar (2x) armarios Ref.: 8806

REF

8814



14,7kg



1x

-  Suporte para fixar 3 módulos de parede
 Soporte para 3x armario alto



-  **Descrição:**
Nota: Para suportar (3x) módulos Ref.: 8806

-  **Descripción:**
Nota: Para soportar (3x) armarios Ref.: 8806

REF

8815



21,5kg



1x

 Kit 8801+8802+8803+8808+8806x2+8807x2
 Kit 8801+8802+8803+8808+8806x2+8807x2



Composição:
8801 (1x) - Armário 2 portas c/ 3 prateleiras
8802 (1x) - Módulo fixo 5 gavetas
8803 (1x) - Módulo fixo 2 portas c/ 1 prateleira
8808 (1x) - Painel madeira para 2 módulos
8806 (2x) - Módulo fixo parede 2 portas
8807 (2x) - Painel perfurado para 1 módulo
Medidas gerais: 1980x457x1981mm

Composición:
8801 (1x) - Armario 2 puertas con 3 estantes
8802 (1x) - Cajonera fijo con 5 cajones
8803 (1x) - Modulo fijo con 2 puertas con 1 estante
8808 (1x) - Encimera para 2 modulos
8806 (2x) - Armario alto 2 puertas
8807 (2x) - Panel perforado para 1 modulo
Medidas generales: 1980x457x1981mm

REF		
8880	132,2kg	1x

 Kit 8801+8802+8803+8804+8809+8807x3+8806x3
 Kit 8801+8802+8803+8804+8809+8807x3+8806x3



Composição:
8801 (1x) - Armário 2 portas c/ 3 prateleiras
8802 (1x) - Módulo fixo 5 gavetas
8803 (1x) - Módulo fixo 2 portas c/ 1 prateleira
8804 (1x) - Módulo Carro C/ 4 Gavetas
8809 (1x) - Painel madeira para 3 módulos
8806 (3x) - Módulo fixo parede 2 portas
8807 (3x) - Painel perfurado para 1 módulo
Medidas gerais: 2640x457x1981mm

Composición:
8801 (1x) - Armario 2 puertas con 3 estantes
8802 (1x) - Cajonera fijo con 5 cajones
8803 (1x) - Modulo fijo con 2 puertas con 1 estante
8804 (1x) - Cajonera móvil con 4 cajones
8809 (1x) - Encimera para 3 modulos
8806 (3x) - Armario alto 2 puertas
8807 (3x) - Panel perforado para 1 modulo
Medidas generales: 2640x457x1981mm

REF		
8881	146,4kg	1x

 KIT 8810+8811+8813+8812x2

 KIT 8810+8811+8813+8812x2

Composição:
 8810 (1x) - Módulo fixo 2 portas p/ canto
 8811 (1x) - Módulo fixo parede p/ canto
 8813 (1x) - Painel madeira para canto
 8812 (2x) - Painel perfurado para canto
Dimensões gerais: 1466*457*1981

Composición:
 8810 (1x) - Módulo de esquina 2 puertas
 8811 (1x) - Módulo esquina superior
 8813 (1x) - Encimera para esquina
 8812 (2x) - Panel perforado para esquina
Dimensiones generales: 1466*457*1981

REF

8882



87,7kg



1x

 KIT 8801+8802+8803+8816+8809+8807x3+8806x3

 KIT 8801+8802+8803+8808+8806x2+8807x2

Composição:
 8801 (1x) - Armário 2 portas c/ 3 prateleiras
 8802 (1x) - Módulo fixo 5 gavetas
 8803 (1x) - Módulo fixo 2 portas c/ 1 prateleira
 8816 (1x) - Módulo carro c/ 7 gavetas
 8809 (1x) - Painel madeira para 3 módulos
 8806 (3x) - Módulo fixo parede 2 portas
 8807 (3x) - Painel perfurado para 1 módulo
Dimensões gerais: 2640x457x1981mm

Composición:
 8801 (1x) - armario 2 puertas con 3 estantes
 8802 (1x) - cajonera fijo con 5 cajones
 8803 (1x) - modulo fijo con 2 puertas con 1 estante
 8816 (1x) - cajonera móvil con 7 cajones
 8809 (1x) - encimera para 3 modulos
 8806 (3x) - armario alto 2 puertas
 8807 (3x) - panel perforado para 1 modulo
Medidas generales: 2640x457x1981mm

REF

8883



155,1kg



1x

 KIT 8801+8802+8805+8804+8809+8807x3+8806x3

 KIT 8801+8802+8805+8804+8809+8807x3+8806x3

Composição:
 8801 (x1) - Armário 2 portas c/ 3 prateleiras
 8802 (x1) - Módulo fixo 5 gavetas
 8805 (x1) - Módulo fixo p/ papel e lixo
 8804 (x1) - Módulo carro c/ 4 gavetas
 8809 (x1) - Painel madeira para 3 módulos
 8806 (x3) - Módulo fixo parede 2 portas
 8807 (x3) - Painel perfurado para 1 módulo
Dimensões gerais: 2640x457x1981mm

Composición:
 8801 (1x) - Armario 2 puertas con 3 estantes
 8802 (1x) - Cajonera fijo con 5 cajones
 8803 (1x) - Modulo fijo con 2 puertas con 1 estante
 8804 (1x) - Cajonera móvil con 4 cajones
 8809 (1x) - Encimera para 3 modulos
 8806 (3x) - Armario alto 2 puertas
 8807 (3x) - Panel perforado para 1 modulo
Medidas generales: 2640x457x1981mm

REF

8884



153,15kg



1x

Imagem demonstrativa com sugestão de composição
 Imagen demostrativa con composición sugerida



Composição:

- Ref: 8801 - (2x) ARMÁRIO 2 PORTAS C/ 3 PRATELEIRAS
- Ref: 8802 - (2x) MÓDULO FIXO 5 GAVETAS
- Ref: 8803 - (1x) MÓDULO FIXO 2 PORTAS C/ 1 PRATELEIRA
- Ref: 8804 - (1x) MÓDULO CARRO C/ 4 GAVETAS
- Ref: 8805 - (1x) MÓDULO FIXO P/ PAPEL E LIXO
- Ref: 8806 - (5x) MÓDULO FIXO PAREDE 2 PORTAS
- Ref: 8807 - (5x) PAINEL PERFURADO PARA 1 MÓDULO
- Ref: 8808 - (1x) PAINEL MADEIRA PARA 2 MÓDULOS
- Ref: 8809 - (1x) PAINEL MADEIRA PARA 3 MÓDULOS
- Ref: 8810 - (1x) MÓDULO FIXO 2 PORTAS P/ CANTO
- Ref: 8811 - (1x) MÓDULO FIXO PAREDE P/ CANTO
- Ref: 8812 - (2x) PAINEL PERFURADO PARA CANTO
- Ref: 8813 - (1x) PAINEL MADEIRA PARA CANTO

Nota: Também pode colocar a Ref.: 8816

Composición:

- Ref: 8801 - (2x) ARMARIO 2 PUERTAS CON 3 ESTANTES
- Ref: 8802 - (2x) CAJONERA FIJO CON 5 CAJONES
- Ref: 8803 - (1x) MODULO FIJO CON 2 PUERTAS CON 1 ESTANTE
- Ref: 8804 - (1x) CAJONERA MÓVIL CON 4 CAJONES
- Ref: 8805 - (1x) MODULO FIJO PORTA-PAPEL
- Ref: 8806 - (5x) ARMARIO ALTO 2 PUERTAS
- Ref: 8807 - (5x) PANEL PERFORADO PARA 1 MODULO
- Ref: 8808 - (1x) ENCIMERA PARA 2 MODULOS
- Ref: 8809 - (1x) ENCIMERA PARA 3 MODULOS
- Ref: 8810 - (1x) MÓDULO DE ESQUINA 2 PUERTAS
- Ref: 8811 - (1x) MÓDULO ESQUINA SUPERIOR
- Ref: 8812 - (2x) PANEL PERFORADO PARA ESQUINA
- Ref: 8813 - (1x) ENCIMERA PARA ESQUINA

Nota: También puede colocar la Ref.: 8816

-  Gancho p/ alicates 150mm
 Gancho especial tenazas 150mm



 **Descrição:**
 Medidas: 150mm
 Compatível com REF. 8807/8812

 **Descripción:**
 Medidas: 150mm
 Compatible con REF. 8807/8812

REF		
8817	137gr	50x

-  Gancho redondo
 Gancho redondo



 **Descrição:**
 Medidas: 40mm; 60mm; 80mm
 Compatível com REF. 8807/8812

 **Descripción:**
 Medidas: 40mm; 60mm; 80mm
 Compatible con REF. 8807/8812

REF			
8818	40mm	70gr	100x
8819	60mm	80gr	100x
8820	80mm	97gr	100x

-  Gancho simples
 Gancho simples



 **Descrição:**
 Medidas: 75mm; 100mm
 Compatível com REF. 8807/8812

 **Descripción:**
 Medidas: 75mm; 100mm
 Compatible con REF. 8807/8812

REF			
8821	75mm	34gr	300x
8822	100mm	39gr	300x

-  Gancho duplo
 Gancho 2 picos



 **Descrição:**
 Medidas: 75mm; 100mm
 Compatível com REF. 8807/8812

 **Descripción:**
 Medidas: 75mm; 100mm
 Compatible con REF. 8807/8812

REF			
8823	75mm	68gr	300x
8824	100mm	79gr	300x

-  Suporte p/ brocas 390x26MM
 Porta taladro 390x26MM



 **Descrição:**
 Medidas: 390x26mm
 Compatível com REF. 8807/8812

 **Descripción:**
 Medidas: 390x26mm
 Compatible con REF. 8807/8812

REF			
8825	390x26mm	507gr	50x

 Suporte chaves 145mm
 Gancho especial llaves 145mm

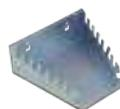

 **Descrição:**
Medidas: 145mm
Compatível com REF. 8807/8812

 **Descripción:**
Medidas: 145mm
Compatible con REF. 8807/8812

REF		
8826	372gr	50x

 Suporte chaves fenda 370mm
 Gancho especial destornilladores 370mm



 **Descrição:**
Medidas: 370mm
Compatível com REF. 8807/8812

 **Descripción:**
Medidas: 370mm
Compatible con REF. 8807/8812

REF		
8827	418gr	50x

 Suporte garrafas 342x80x75mm
 Soporte botellas 342x80x75mm



 **Descrição:**
Medidas: Comprimento: 342mm x Profundidade: 80mm x Altura: 75mm
Compatível com REF. 8807/8812

 **Descripción:**
Medidas: Largo: 342mm x Fondo: 80mm x Alto: 75mm
Compatible con REF. 8807/8812

REF		
8828	758gr	12x

 Caixa plástica 190x105x75mm
 Caja plástica 190x105x75mm



 **Descrição:**
Medidas: 190x105x75mm
Compatível com REF. 8807/8812

 **Descripción:**
Medidas: 190x105x75mm
Compatible con REF. 8807/8812

REF		
8829	150gr	24x

 Caixa plástica 110x105x50mm
 Caja plástica 110x105x50mm



 **Descrição:**
Medidas: 110x105x50 mm
Compatível com REF. 8807/8812

 **Descripción:**
Medidas: 110x105x50mm
Compatible con REF. 8807/8812

REF		
8830	118gr	60x

-  Armário com persiana 1,5M
 Armário con persiana 1,5M

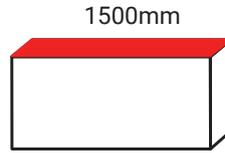
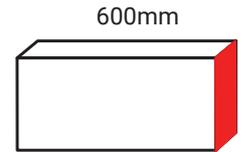
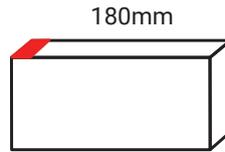

REF

8507



29kg



1x

-  Bancada de trabalho 2MT c/ 2 gavetas
 Banco de trabajo 2MT con 2 cajones

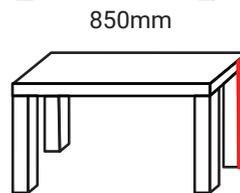
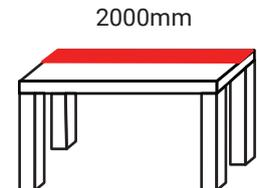
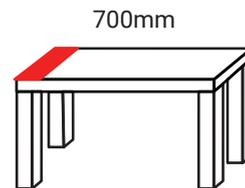

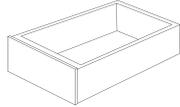
2x		<p>Dimensões internas/Dimensiones interiores: 568x420x120mm</p> <p>Dimensões externas/Dimensiones exteriores: 590x444x122mm</p>
----	---	---

REF

8480



80kg



1x

-  Armário de ferramentas com 4 gavetas vazio
 Cofre de herramientas con 4 cajones vacío

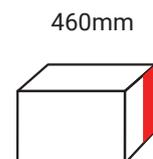
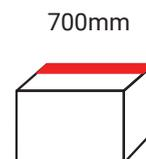
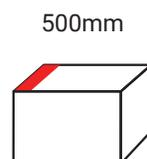

4x		535mm x 400mm x 60mm
----	--	----------------------

REF

8504



29kg



1x

- Torno de bancada base fixa - 4" (100mm)
- Tornillo de banco con base fija - 4" (100mm)

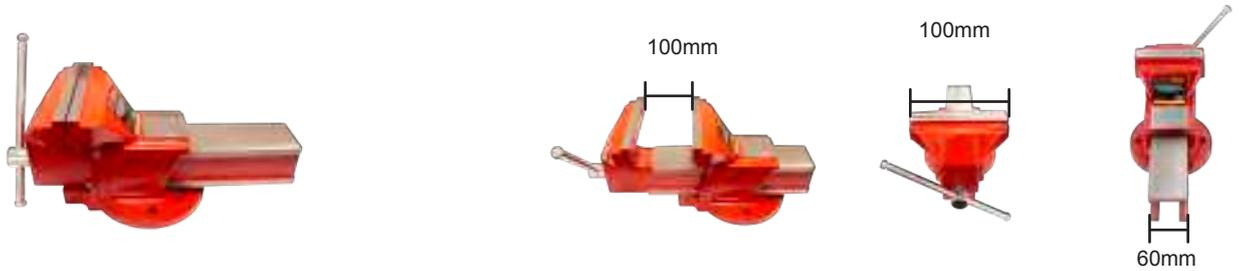

REF	Medida	Peso	Cantidad
8004	100mm (4")	6,3kg	2x

- Torno de bancada base fixa - 6" (150mm)
- Tornillo de banco con base fija - 6" (150mm)

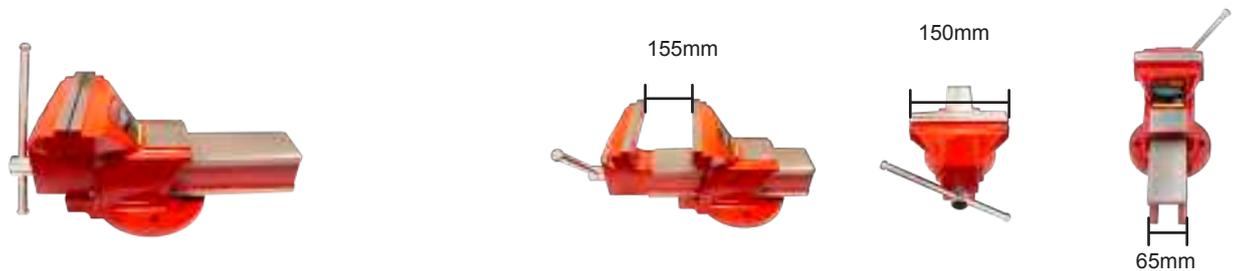

REF	Medida	Peso	Cantidad
8006	155mm (6")	11,3kg	1x

- Torno de bancada base fixa - 8" (200mm)
- Tornillo de banco con base fija - 8" (200mm)

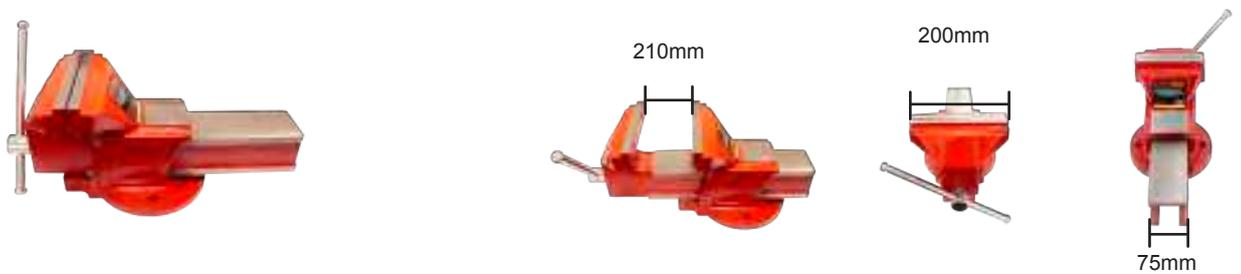

REF	Medida	Peso	Cantidad
8008	210mm (8")	14,6kg	1x

- Kit 2 painéis perfurados com 32 acessórios
- Kit 2 paneles perforados con 32 accesorios

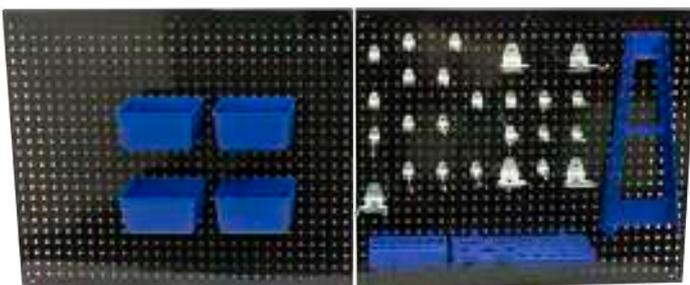

- Medidas:** 550x455mm
Espessura/Espesora: 0,5mm
Composição/Composición:
 (32x) Acessórios/Accesorios
 (15x) Ganchos simples curtos/cortos
 (5x) Ganchos longos simples/simples largos
 (2x) Ganchos duplos/dobles
 (3x) Ganchos de laço/bucle
 (4x) Caixas/Cajas de plástico
 (1x) Suporte chaves/Soporte llaves
 (1x) Suporte chaves de punho/Soporte destornilladores
 (1x) Suporte brocas/Soporte taladros

REF	Peso	Cantidad
8685	3,4kg	1x

 Kit acessórios para painéis perfurados 32 peças
 Kit accesorios para paneles perforados 32 piezas

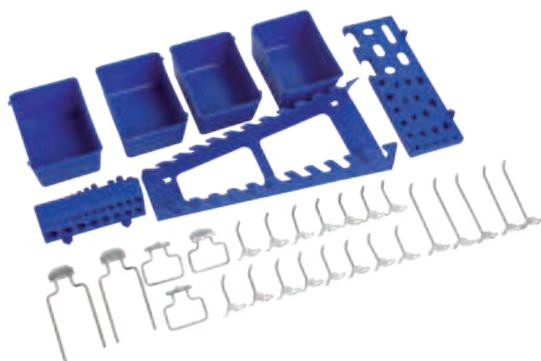
**Composição/Composición:**

(32x) Acessórios/Accesorios
 (15x) Ganchos simples curtos/cortos
 (5x) Ganchos longos simples/simples largos
 (2x) Ganchos duplos/dobles
 (3x) Ganchos de laço/bucle
 (4x) Caixas/Cajas de plástico
 (1x) Suporte chaves/Soporte llaves
 (1x) Suporte chaves de punho/Soporte destornilladores
 (1x) Suporte brocas/Soporte taladros

REF



8686

900gr

20x

 Chave de caixa 1/4"
 Llave de vaso 1/4"   



REF	⊕	⊥	TIPO	FACES/ CARAS	⚖	📄
140604	4mm	25mm	CURTA/CORTO	Hex	16gr	200x
140645	4,5mm	25mm	CURTA/CORTO	Hex	16gr	200x
140605	5mm	25mm	CURTA/CORTO	Hex	16,5gr	200x
140655	5,5mm	25mm	CURTA/CORTO	Hex	15gr	200xx
140606	6mm	25mm	CURTA/CORTO	Hex	16,6gr	300x
140607	7mm	25mm	CURTA/CORTO	Hex	15gr	500x
140608	8mm	25mm	CURTA/CORTO	Hex	16gr	500x
140609	9mm	25mm	CURTA/CORTO	Hex	10gr	1x
140610	10mm	25mm	CURTA/CORTO	Hex	22gr	500x
140611	11mm	25mm	CURTA/CORTO	Hex	10gr	1x
140612	12mm	25mm	CURTA/CORTO	Hex	10gr	100x
140613	13mm	25mm	CURTA/CORTO	Hex	10gr	1x
140614	14mm	25mm	CURTA/CORTO	Hex	15gr	1x
140604L	4mm	50mm	LONGA/LARGA	Hex	26gr	150x
140605L	5mm	50mm	LONGA/LARGA	Hex	10gr	250x
140606L	6mm	50mm	LONGA/LARGA	Hex	23gr	500x
140607L	7mm	50mm	LONGA/LARGA	Hex	10gr	1x
140608L	8mm	50mm	LONGA/LARGA	Hex	10gr	250x
140609L	9mm	50mm	LONGA/LARGA	Hex	30gr	150x
140610L	10mm	60mm	LONGA/LARGA	Hex	34gr	500x
140611L	11mm	50mm	LONGA/LARGA	Hex	44gr	250x
140612L	12mm	50mm	LONGA/LARGA	Hex	10gr	1x
140613L	13mm	60mm	LONGA/LARGA	Hex	10gr	1x
140614L	14mm	50mm	LONGA/LARGA	Hex	10gr	1x
141204	4mm	25mm	CURTA/CORTO	Bihex	15gr	1x
1412045	4,5mm	25mm	CURTA/CORTO	Bihex	15gr	1x
141205	5mm	25mm	CURTA/CORTO	Bihex	15gr	1x
1412055	5,5mm	25mm	CURTA/CORTO	Bihex	15gr	1x

REF	⊕	⊥	TIPO	FACES/ CARAS	⚖	📄
141206	6mm	25mm	CURTA/CORTO	Bihex	15gr	1x
141207	7mm	25mm	CURTA/CORTO	Bihex	15gr	1x
141208	8mm	25mm	CURTA/CORTO	Bihex	15gr	1x
141209	9mm	25mm	CURTA/CORTO	Bihex	20gr	1x
141210	10mm	25mm	CURTA/CORTO	Bihex	20gr	1x
141211	11mm	25mm	CURTA/CORTO	Bihex	20gr	1x
141212	12mm	25mm	CURTA/CORTO	Bihex	25gr	1x
141213	13mm	25mm	CURTA/CORTO	Bihex	26gr	1x
141214	14mm	25mm	CURTA/CORTO	Bihex	33gr	1x
141204L	4mm	50mm	LONGA/LARGA	Bihex	20gr	1x
141205L	5mm	50mm	LONGA/LARGA	Bihex	20gr	1x
141206L	6mm	50mm	LONGA/LARGA	Bihex	20gr	1x
141207L	7mm	50mm	LONGA/LARGA	Bihex	20gr	1x
141208L	8mm	50mm	LONGA/LARGA	Bihex	25gr	1x
141209L	9mm	50mm	LONGA/LARGA	Bihex	25gr	1x
141210L	10mm	50mm	LONGA/LARGA	Bihex	35gr	1x
141211L	11mm	50mm	LONGA/LARGA	Bihex	44gr	1x
141212L	12mm	50mm	LONGA/LARGA	Bihex	44gr	1x
141213L	13mm	50mm	LONGA/LARGA	Bihex	55gr	1x
141214L	14mm	50mm	LONGA/LARGA	Bihex	58gr	1x
1404E	E4	25mm	CURTA/CORTO	Torx	10gr	500x
1405E	E5	25mm	CURTA/CORTO	Torx	10gr	500x
1406E	E6	25mm	CURTA/CORTO	Torx	15gr	200x
1407E	E7	25mm	CURTA/CORTO	Torx	11,5gr	1000x
1408E	E7	25mm	CURTA/CORTO	Torx	15gr	1x
1410E	E10	25mm	CURTA/CORTO	Torx	16gr	500x
1411E	E11	25mm	CURTA/CORTO	Torx	20gr	1x

Chave de caixa 3/8"  
Llave de vaso 3/8"



REF	⊕	ℓ	TIPO	FACES/ CARAS	⚖	📄
130608	8mm	28mm	CURTA/CORTO	Hex	30gr	1x
130609	9mm	28mm	CURTA/CORTO	Hex	30gr	150x
130610	10mm	28mm	CURTA/CORTO	Hex	30gr	1x
130611	11mm	28mm	CURTA/CORTO	Hex	30gr	1x
130612	12mm	28mm	CURTA/CORTO	Hex	34gr	200x
130613	13mm	28mm	CURTA/CORTO	Hex	40gr	200x
130614	14mm	28mm	CURTA/CORTO	Hex	41gr	200x
130615	15mm	28mm	CURTA/CORTO	Hex	50gr	1x
130616	16mm	28mm	CURTA/CORTO	Hex	50gr	1x
130617	17mm	28mm	CURTA/CORTO	Hex	52,5gr	200x
130618	18mm	28mm	CURTA/CORTO	Hex	72gr	1x
130619	19mm	28mm	CURTA/CORTO	Hex	78gr	1x
130621	21mm	28mm	CURTA/CORTO	Hex	80gr	200x
130622	22mm	28mm	CURTA/CORTO	Hex	80gr	200x
130624	24mm	28mm	CURTA/CORTO	Hex	105gr	100x

REF	⊕	ℓ	TIPO	FACES/ CARAS	⚖	📄
130630	30mm	28mm	CURTA/CORTO	Hex	90gr	1x
130610L	10mm	47mm	LONGA/LARGA	Hex	45gr	200x
130611L	11mm	47mm	LONGA/LARGA	Hex	60gr	1x
130612L	12mm	47mm	LONGA/LARGA	Hex	66gr	200x
130613L	13mm	47mm	LONGA/LARGA	Hex	65gr	200x
130614L	14mm	47mm	LONGA/LARGA	Hex	75gr	1x
130615L	15mm	47mm	LONGA/LARGA	Hex	80gr	1x
3808E	E8	28mm	CURTA/CORTO	Torx	26gr	500x
3810E	E10	28mm	CURTA/CORTO	Torx	35gr	200x
3811E	E11	28mm	CURTA/CORTO	Torx	36gr	200x
3812E	E12	28mm	CURTA/CORTO	Torx	37gr	500x
3814E	E14	28mm	CURTA/CORTO	Torx	40gr	200x
3816E	E16	28mm	CURTA/CORTO	Torx	45gr	1x
3818E	E18	28mm	CURTA/CORTO	Torx	50gr	1x

Chave de caixa 1/2"  
Llave de vaso 1/2"



REF	⊕	ℓ	TIPO	FACES/ CARAS	⚖	📄
120608	8mm	8mm	CURTA/CORTO	Hex	50gr	200x
120609	9mm	38mm	CURTA/CORTO	Hex	50gr	1x
120610	10mm	38mm	CURTA/CORTO	Hex	50gr	1x
120611	11mm	38mm	CURTA/CORTO	Hex	50gr	1x
120612	12mm	38mm	CURTA/CORTO	Hex	52,5gr	200x
120613	13mm	38mm	CURTA/CORTO	Hex	50gr	1x
120614	14mm	38mm	CURTA/CORTO	Hex	60gr	100x
120615	15mm	38mm	CURTA/CORTO	Hex	60gr	100x
120616	16mm	38mm	CURTA/CORTO	Hex	60gr	100x
120617	17mm	38mm	CURTA/CORTO	Hex	70gr	200x
120618	18mm	38mm	CURTA/CORTO	Hex	60gr	1x
120619	19mm	38mm	CURTA/CORTO	Hex	80gr	200x
120620	20mm	38mm	CURTA/CORTO	Hex	90gr	1x
120621	21mm	38mm	CURTA/CORTO	Hex	95gr	200x
120622	22mm	38mm	CURTA/CORTO	Hex	90gr	100x
120623	23mm	38mm	CURTA/CORTO	Hex	100gr	1x
120624	24mm	38mm	CURTA/CORTO	Hex	110gr	200x
120625	25mm	38mm	CURTA/CORTO	Hex	150gr	100x
120626	26mm	38mm	CURTA/CORTO	Hex	132gr	1x
120627	27mm	38mm	CURTA/CORTO	Hex	160gr	1x
120628	28mm	38mm	CURTA/CORTO	Hex	170gr	1x
120629	29mm	38mm	CURTA/CORTO	Hex	180gr	1x
120630	30mm	38mm	CURTA/CORTO	Hex	215gr	50x

REF	⊕	ℓ	TIPO	FACES/ CARAS	⚖	📄
120632	32mm	38mm	CURTA/CORTO	Hex	190gr	50x
120610L	10mm	77mm	LONGA/LARGA	Hex	86gr	1x
120611L	11mm	77mm	LONGA/LARGA	Hex	106gr	100x
120612L	12mm	77mm	LONGA/LARGA	Hex	100gr	100x
120613L	13mm	77mm	LONGA/LARGA	Hex	100gr	100x
120614L	14mm	77mm	LONGA/LARGA	Hex	100gr	200x
120615L	15mm	77mm	LONGA/LARGA	Hex	100gr	50x
120616L	16mm	77mm	LONGA/LARGA	Hex	100gr	80x
120617L	17mm	77mm	LONGA/LARGA	Hex	121gr	200x
120618L	18mm	77mm	LONGA/LARGA	Hex	137gr	200x
120619L	19mm	77mm	LONGA/LARGA	Hex	160gr	1x
120620L	20mm	77mm	LONGA/LARGA	Hex	164gr	50x
120621L	21mm	77mm	LONGA/LARGA	Hex	175gr	120x
120622L	22mm	77mm	LONGA/LARGA	Hex	195gr	100x
120624L	24mm	77mm	LONGA/LARGA	Hex	200gr	50x
120627L	27mm	77mm	LONGA/LARGA	Hex	286gr	60x
120629L	29mm	77mm	LONGA/LARGA	Hex	290gr	1x
120630L	30mm	77mm	LONGA/LARGA	Hex	340gr	1x
120632L	32mm	77mm	LONGA/LARGA	Hex	360gr	1x
121208	8mm	38mm	CURTA/CORTO	Bihex	50gr	1x
121209	9mm	38mm	CURTA/CORTO	Bihex	52,5gr	200x
121210	10mm	38mm	CURTA/CORTO	Bihex	52,5gr	200x
121211	11mm	38mm	CURTA/CORTO	Bihex	55gr	1x

REF	⊕	⊥	TIPO	FACES/ CARAS	📏	📄
121212	12mm	38mm	CURTA/CORTO	Bihex	55gr	1x
121213	13mm	38mm	CURTA/CORTO	Bihex	59gr	100x
121214	14mm	38mm	CURTA/CORTO	Bihex	75gr	200x
121215	15mm	38mm	CURTA/CORTO	Bihex	55gr	200x
121216	16mm	38mm	CURTA/CORTO	Bihex	52gr	200x
121217	17mm	38mm	CURTA/CORTO	Bihex	60gr	200x
121218	18mm	38mm	CURTA/CORTO	Bihex	73gr	1x
121219	19mm	38mm	CURTA/CORTO	Bihex	80gr	200x
121220	20mm	38mm	CURTA/CORTO	Bihex	87gr	100x
121221	21mm	38mm	CURTA/CORTO	Bihex	96gr	1x
121222	22mm	38mm	CURTA/CORTO	Bihex	95gr	100x
121223	23mm	38mm	CURTA/CORTO	Bihex	120gr	100x
121224	24mm	38mm	CURTA/CORTO	Bihex	120gr	108x
121225	25mm	38mm	CURTA/CORTO	Bihex	110gr	1x
121226	26mm	38mm	CURTA/CORTO	Bihex	120gr	1x
121227	27mm	38mm	CURTA/CORTO	Bihex	130gr	1x
121228	28mm	38mm	CURTA/CORTO	Bihex	130gr	100x
121229	29mm	38mm	CURTA/CORTO	Bihex	130gr	1x
121230	30mm	38mm	CURTA/CORTO	Bihex	180gr	1x
121232	32mm	38mm	CURTA/CORTO	Bihex	192gr	40x
121210L	10mm	77mm	LONGA/LARGA	Bihex	90gr	1x
121211L	11mm	77mm	LONGA/LARGA	Bihex	90gr	1x
121212L	12mm	77mm	LONGA/LARGA	Bihex	110gr	100x
121213L	13mm	77mm	LONGA/LARGA	Bihex	100gr	1x
121214L	14mm	77mm	LONGA/LARGA	Bihex	120gr	100x
121215L	15mm	77mm	LONGA/LARGA	Bihex	130gr	1x
121216L	16mm	77mm	LONGA/LARGA	Bihex	98gr	100x
121217L	17mm	77mm	LONGA/LARGA	Bihex	150gr	1x
121218L	18mm	77mm	LONGA/LARGA	Bihex	160gr	100x
121219L	19mm	77mm	LONGA/LARGA	Bihex	150gr	200x

REF	⊕	⊥	TIPO	FACES/ CARAS	📏	📄
121220L	20mm	77mm	LONGA/LARGA	Bihex	350gr	50x
121221L	21mm	77mm	LONGA/LARGA	Bihex	170gr	100x
121222L	22mm	77mm	LONGA/LARGA	Bihex	215gr	100x
121223L	23mm	77mm	LONGA/LARGA	Bihex	200gr	1x
121224L	24mm	77mm	LONGA/LARGA	Bihex	210gr	1x
121226L	26mm	77mm	LONGA/LARGA	Bihex	230gr	1x
121227L	27mm	77mm	LONGA/LARGA	Bihex	240gr	1x
121228L	28mm	77mm	LONGA/LARGA	Bihex	290gr	50x
121229L	29mm	77mm	LONGA/LARGA	Bihex	270gr	1x
121230L	30mm	77mm	LONGA/LARGA	Bihex	280gr	1x
121232L	32mm	77mm	LONGA/LARGA	Bihex	300gr	1x
1210E	E10	38mm	CURTA/CORTO	Torx	52,5gr	200x
1211E	E11	38mm	CURTA/CORTO	Torx	50gr	1x
1212E	E12	38mm	CURTA/CORTO	Torx	50gr	1x
1214E	E14	38mm	CURTA/CORTO	Torx	50gr	1x
1216E	E16	38mm	CURTA/CORTO	Torx	65gr	200x
1218E	E18	38mm	CURTA/CORTO	Torx	72,5gr	200x
1220E	E20	38mm	CURTA/CORTO	Torx	80gr	1x
1222E	E22	38mm	CURTA/CORTO	Torx	85gr	200x
1224E	E24	38mm	CURTA/CORTO	Torx	105gr	100x
1210EL	E10	78mm	LONGA/LARGA	Torx	96gr	60x
1211EL	E11	78mm	LONGA/LARGA	Torx	108gr	60x
1212EL	E12	78mm	LONGA/LARGA	Torx	108gr	60x
1214EL	E14	78mm	LONGA/LARGA	Torx	110gr	60x
1216EL	E16	78mm	LONGA/LARGA	Torx	110gr	60x
1218EL	E18	78mm	LONGA/LARGA	Torx	145gr	60x
1220EL	E20	78mm	LONGA/LARGA	Torx	155gr	60x
1222EL	E22	78mm	LONGA/LARGA	Torx	175gr	60x
1224EL	E24	78mm	LONGA/LARGA	Torx	203gr	60x

 Chave de caixa 1/2" impacto     
 Llave de vaso 1/2" impacto



REF	⊕	⊥	TIPO	FACES/ CARAS	📏	📄
1210	10mm	38mm	CURTO/CORTA	Hex	70gr	100x
1211	11mm	38mm	CURTO/CORTA	Hex	80gr	1x
1212	12mm	38mm	CURTO/CORTA	Hex	75gr	100x
1213	13mm	38mm	CURTO/CORTA	Hex	80gr	1x
1214	14mm	38mm	CURTO/CORTA	Hex	78gr	100x
1215	15mm	38mm	CURTO/CORTA	Hex	120gr	1x
1216	16mm	38mm	CURTO/CORTA	Hex	120gr	1x
1217	17mm	38mm	CURTO/CORTA	Hex	120gr	100x
1218	18mm	38mm	CURTO/CORTA	Hex	120gr	1x
1219	19mm	38mm	CURTO/CORTA	Hex	105gr	200x
1220	20mm	38mm	CURTO/CORTA	Hex	120gr	1x
1221	21mm	39mm	CURTO/CORTA	Hex	125gr	100x
1222	22mm	39mm	CURTO/CORTA	Hex	140gr	100x

REF	⊕	⊥	TIPO	FACES/ CARAS	📏	📄
1223	23mm	41mm	CURTO/CORTA	Hex	140gr	1x
1224	24mm	41mm	CURTO/CORTA	Hex	137gr	1x
1225	25mm	44mm	CURTO/CORTA	Hex	170gr	1x
1226	26mm	44mm	CURTO/CORTA	Hex	180gr	1x
1227	27mm	44mm	CURTO/CORTA	Hex	195gr	100x
1228	28mm	44mm	CURTO/CORTA	Hex	215gr	1x
1229	29mm	44mm	CURTO/CORTA	Hex	200gr	1x
1230	30mm	50mm	CURTO/CORTA	Hex	207gr	50x
1232	32mm	50mm	CURTO/CORTA	Hex	222gr	1x
1210L	10mm	80mm	LONGO/LARGA	Hex	140gr	50x
1211L	11mm	80mm	LONGO/LARGA	Hex	140gr	100x
1212L	12mm	80mm	LONGO/LARGA	Hex	160gr	100x
1213L	13mm	80mm	LONGO/LARGA	Hex	160gr	100x

REF	⊕	⊥	TIPO	FACES/ CARAS	⚖	📄
1214L	14mm	80mm	LONGO/LARGA	Hex	140gr	50x
1215L	15mm	80mm	LONGO/LARGA	Hex	155gr	100x
1216L	16mm	80mm	LONGO/LARGA	Hex	150gr	100x
1217L	17mm	80mm	LONGO/LARGA	Hex	125gr	100x
1218L	18mm	80mm	LONGO/LARGA	Hex	190gr	100x
1219L	19mm	80mm	LONGO/LARGA	Hex	220gr	50x
1220L	20mm	80mm	LONGO/LARGA	Hex	260gr	100x
1221L	21mm	80mm	LONGO/LARGA	Hex	275gr	50x
1222L	22mm	80mm	LONGO/LARGA	Hex	270gr	50x
1223L	23mm	80mm	LONGO/LARGA	Hex	300gr	1x
1224L	24mm	80mm	LONGO/LARGA	Hex	320gr	50x
1225L	25mm	80mm	LONGO/LARGA	Hex	350gr	1x
1226L	26mm	80mm	LONGO/LARGA	Hex	350gr	1x
1227L	27mm	80mm	LONGO/LARGA	Hex	360gr	50x
1228L	28mm	80mm	LONGO/LARGA	Hex	350gr	1x
1229L	29mm	80mm	LONGO/LARGA	Hex	400gr	1x
1230L	30mm	80mm	LONGO/LARGA	Hex	375gr	40x
1232L	32mm	80mm	LONGO/LARGA	Hex	450gr	100x
125004	4mm	78mm	LONGO/LARGA	Hex	70gr	1x
125005	5mm	78mm	LONGO/LARGA	Hex	75gr	1x
125006	6mm	78mm	LONGO/LARGA	Hex	100gr	100x
125008	8mm	78mm	LONGO/LARGA	Hex	85gr	1x
125010	10mm	78mm	LONGO/LARGA	Hex	110gr	1x
125012	12mm	78mm	LONGO/LARGA	Hex	120gr	1x
125014	14mm	78mm	LONGO/LARGA	Hex	138gr	60x
125017	17mm	78mm	LONGO/LARGA	Hex	173gr	60x
125019	19mm	78mm	LONGO/LARGA	Hex	215gr	1x
125020	T20	78mm	LONGO/LARGA	Torx	57,5gr	60x

REF	⊕	⊥	TIPO	FACES/ CARAS	⚖	📄
125025	T25	78mm	LONGO/LARGA	Torx	62gr	1x
125027	T27	78mm	LONGO/LARGA	Torx	62gr	60x
125030	T30	78mm	LONGO/LARGA	Torx	215gr	100x
125040	T40	78mm	LONGO/LARGA	Torx	90gr	100x
125045	T45	78mm	LONGO/LARGA	Torx	85gr	100x
125050	T50	78mm	LONGO/LARGA	Torx	95gr	100x
125055	T55	78mm	LONGO/LARGA	Torx	105gr	100x
125060	T60	78mm	LONGO/LARGA	Torx	74gr	1x
125070	T70	78mm	LONGO/LARGA	Torx	140gr	1x
124004	M4	78mm	LONGO/LARGA	xzn	62gr	1x
124005	M5	78mm	LONGO/LARGA	xzn	62gr	1x
124006	M6	78mm	LONGO/LARGA	xzn	64gr	100x
124008	M8	78mm	LONGO/LARGA	xzn	64gr	1x
124009	M9	78mm	LONGO/LARGA	xzn	67gr	1x
124010	M10	78mm	LONGO/LARGA	xzn	100gr	100x
124012	M12	78mm	LONGO/LARGA	xzn	109gr	100x
124014	M14	78mm	LONGO/LARGA	xzn	124gr	100x
124016	M16	78mm	LONGO/LARGA	xzn	160gr	100x
123005	R5	78mm	LONGO/LARGA	ribe	220gr	1x
123006	R6	78mm	LONGO/LARGA	ribe	70gr	1x
123007	R7	78mm	LONGO/LARGA	ribe	86gr	100x
123008	R8	78mm	LONGO/LARGA	ribe	89gr	100x
123009	R9	78mm	LONGO/LARGA	ribe	90gr	1x
123010	R10	78mm	LONGO/LARGA	ribe	99gr	100x
123011	R11	78mm	LONGO/LARGA	ribe	117gr	80x
123012	R12	78mm	LONGO/LARGA	ribe	187gr	80x
123013	R13	78mm	LONGO/LARGA	ribe	85gr	1x
123014	R14	78mm	LONGO/LARGA	ribe	100gr	1x

 **Chave de caixa 3/4"** 
Llave de vaso 3/4"



REF	⊕	⊥	TIPO	FACES/ CARAS	⚖	📄
340617	17mm	50mm	CURTA/CORTO	Hex	150gr	1x
340619	19mm	50mm	CURTA/CORTO	Hex	177gr	1x
340621	21mm	50mm	CURTA/CORTO	Hex	235gr	100x
340622	22mm	51mm	CURTA/CORTO	Hex	360gr	50x
340623	23mm	51mm	CURTA/CORTO	Hex	222gr	1x
340624	24mm	51mm	CURTA/CORTO	Hex	240gr	50x
340626	26mm	52mm	CURTA/CORTO	Hex	280gr	1x
340627	27mm	53mm	CURTA/CORTO	Hex	360gr	50x
340628	28mm	53mm	CURTA/CORTO	Hex	300gr	1x
340629	29mm	53mm	CURTA/CORTO	Hex	360gr	50x
340630	30mm	54mm	CURTA/CORTO	Hex	283gr	60x
340632	32mm	56mm	CURTA/CORTO	Hex	330gr	50x
340633	33mm	56mm	CURTA/CORTO	Hex	340gr	30x

REF	⊕	⊥	TIPO	FACES/ CARAS	⚖	📄
340634	34mm	56mm	CURTA/CORTO	Hex	390gr	30x
340635	35mm	58mm	CURTA/CORTO	Hex	425gr	20x
340636	36mm	58mm	CURTA/CORTO	Hex	360gr	50x
340638	38mm	60mm	CURTA/CORTO	Hex	275gr	50x
340641	41mm	60mm	CURTA/CORTO	Hex	600gr	30x
340646	46mm	68mm	CURTA/CORTO	Hex	700gr	20x
340650	50mm	73mm	CURTA/CORTO	Hex	600gr	30x
340655	55mm	76mm	CURTA/CORTO	Hex	1,05kg	20x
340660	60mm	76mm	CURTA/CORTO	Hex	1,1kg	1x
341217	17mm	50mm	CURTA/CORTO	Bihex	150gr	1x
341219	19mm	50mm	CURTA/CORTO	Bihex	170gr	1x
341221	21mm	51mm	CURTA/CORTO	Bihex	200gr	1x
341222	22mm	51mm	CURTA/CORTO	Bihex	360gr	50x

REF	⊕	⊥	TIPO	FACES/ CARAS	📏	📦
341223	23mm	51mm	CURTA/CORTO	Bihex	200gr	1x
341224	24mm	52mm	CURTA/CORTO	Bihex	240gr	50x
341225	25mm	52mm	CURTA/CORTO	Bihex	222gr	1x
341226	26mm	52mm	CURTA/CORTO	Bihex	360gr	50x
341227	27mm	53mm	CURTA/CORTO	Bihex	270gr	50x
341228	28mm	53mm	CURTA/CORTO	Bihex	280gr	1x
341229	29mm	53mm	CURTA/CORTO	Bihex	290gr	1x
341230	30mm	54mm	CURTA/CORTO	Bihex	300gr	30x
341232	32mm	56mm	CURTA/CORTO	Bihex	330gr	1x
341233	33mm	56mm	CURTA/CORTO	Bihex	340gr	1x

REF	⊕	⊥	TIPO	FACES/ CARAS	📏	📦
341234	34mm	56mm	CURTA/CORTO	Bihex	360gr	20x
341235	35mm	58mm	CURTA/CORTO	Bihex	400gr	20x
341236	36mm	58mm	CURTA/CORTO	Bihex	360gr	50x
341238	38mm	60mm	CURTA/CORTO	Bihex	375gr	50x
341241	41mm	60mm	CURTA/CORTO	Bihex	550gr	40x
341246	46mm	68mm	CURTA/CORTO	Bihex	600gr	20x
341250	50mm	73mm	CURTA/CORTO	Bihex	840gr	1x
341255	55mm	76mm	CURTA/CORTO	Bihex	1kg	20x
341260	60mm	78mm	CURTA/CORTO	Bihex	1,1kg	1x

Chave de caixa 3/4" impacto 

Llave de vaso 3/4" impacto



REF	⊕	⊥	TIPO	FACES/ CARAS	📏	📦
3417	17mm	54mm	CURTO/CORTA	Hex	300gr	1x
3419	19mm	54mm	CURTO/CORTA	Hex	293gr	60x
3421	21mm	54mm	CURTO/CORTA	Hex	320gr	1x
3422	22mm	54mm	CURTO/CORTA	Hex	350gr	40x
3423	23mm	54mm	CURTO/CORTA	Hex	360gr	1x
3424	24mm	54mm	CURTO/CORTA	Hex	300gr	60x
3426	26mm	54mm	CURTO/CORTA	Hex	350gr	1x
3427	27mm	54mm	CURTO/CORTA	Hex	450gr	40x
3428	28mm	54mm	CURTO/CORTA	Hex	360gr	1x
3429	29mm	54mm	CURTO/CORTA	Hex	390gr	1x
3430	30mm	54mm	CURTO/CORTA	Hex	380gr	20x
3432	32mm	54mm	CURTO/CORTA	Hex	490gr	1x
3433	33mm	54mm	CURTO/CORTA	Hex	550gr	1x
3434	34mm	54mm	CURTO/CORTA	Hex	470gr	1x
3435	35mm	57mm	CURTO/CORTA	Hex	590gr	1x
3436	36mm	57mm	CURTO/CORTA	Hex	412gr	20x

REF	⊕	⊥	TIPO	FACES/ CARAS	📏	📦
3438	38mm	58mm	CURTO/CORTA	Hex	700gr	1x
3441	41mm	58mm	CURTO/CORTA	Hex	740gr	1x
3446	46mm	61mm	CURTO/CORTA	Hex	940gr	1x
3417L	17mm	80mm	LONGO/LARGA	Hex	400gr	25x
3419L	19mm	80mm	LONGO/LARGA	Hex	470gr	25x
3421L	21mm	80mm	LONGO/LARGA	Hex	510gr	1x
3423L	23mm	80mm	LONGO/LARGA	Hex	530gr	1x
3424L	24mm	80mm	LONGO/LARGA	Hex	512gr	25x
3426L	26mm	89mm	LONGO/LARGA	Hex	570gr	1x
3427L	27mm	89mm	LONGO/LARGA	Hex	552gr	25x
3429L	29mm	89mm	LONGO/LARGA	Hex	650gr	1x
3433L	33mm	89mm	LONGO/LARGA	Hex	800gr	1x
3435L	35mm	89mm	LONGO/LARGA	Hex	940gr	1x
3436L	36mm	89mm	LONGO/LARGA	Hex	632gr	25x
3438L	38mm	89mm	LONGO/LARGA	Hex	1,04kg	20x
3441L	41mm	89mm	LONGO/LARGA	Hex	1,07kg	20x

Chave de caixa 1" 

Llave de vaso 1"



REF	⊕	⊥	TIPO	FACES/ CARAS	📏	📦
100636	36mm	65mm	CURTA/CORTA	Hex	551gr	16x
100637	37mm	65mm	CURTA/CORTA	Hex	563gr	16x
100638	38mm	65mm	CURTA/CORTA	Hex	607gr	16x
100639	39mm	65mm	CURTA/CORTA	Hex	608gr	16x
100640	40mm	70mm	CURTA/CORTA	Hex	620gr	16x
100641	41mm	75mm	CURTA/CORTA	Hex	668gr	16x
100642	42mm	75mm	CURTA/CORTA	Hex	690gr	16x
100643	43mm	75mm	CURTA/CORTA	Hex	706gr	16x
100644	44mm	75mm	CURTA/CORTA	Hex	775gr	20x

REF	⊕	⊥	TIPO	FACES/ CARAS	📏	📦
100645	45mm	77mm	CURTA/CORTA	Hex	709gr	16x
100646	46mm	77mm	CURTA/CORTA	Hex	687gr	16x
100647	47mm	77mm	CURTA/CORTA	Hex	976gr	16x
100648	48mm	77mm	CURTA/CORTA	Hex	993gr	16x
100649	49mm	77mm	CURTA/CORTA	Hex	1,07kg	16x
100650	50mm	77mm	CURTA/CORTA	Hex	1,07kg	16x
100652	52mm	77mm	CURTA/CORTA	Hex	812gr	16x
100654	54mm	77mm	CURTA/CORTA	Hex	916kg	12x
100655	55mm	80mm	CURTA/CORTA	Hex	1kg	12x

REF	⊕	⊥	TIPO	FACES/ CARAS	📏	📦
100656	56mm	80mm	CURTA/CORTA	Hex	1,22kg	8x
100657	57mm	80mm	CURTA/CORTA	Hex	1,41kg	12x
100658	58mm	80mm	CURTA/CORTA	Hex	1,24kg	8x
100659	59mm	80mm	CURTA/CORTA	Hex	1,24kg	8x
100660	60mm	84mm	CURTA/CORTA	Hex	1,16kg	12x

REF	⊕	⊥	TIPO	FACES/ CARAS	📏	📦
100663	63mm	84mm	CURTA/CORTA	Hex	1,52kg	8x
100665	65mm	87mm	CURTA/CORTA	Hex	1,65kg	12x
100670	70mm	76mm	CURTA/CORTA	Hex	1,83kg	12x
100675	75mm	81mm	CURTA/CORTA	Hex	1,75kg	8x
100680	80mm	85mm	CURTA/CORTA	Hex	2,42kg	6x

 Chave impacto 1" 
 Llave impacto 1"



REF	⊕	⊥	TIPO	FACES/ CARAS	📏	📦
200119	19mm	58mm	CURTA/CORTA	Hex	583gr	25x
200121	21mm	58mm	CURTA/CORTA	Hex	583gr	24x
200123	23mm	58mm	CURTA/CORTA	Hex	583gr	24x
200124	24mm	58mm	CURTA/CORTA	Hex	516gr	24x
200126	26mm	58mm	CURTA/CORTA	Hex	583gr	25x
200127	27mm	58mm	CURTA/CORTA	Hex	629gr	25x
200128	28mm	58mm	CURTA/CORTA	Hex	583gr	24x
200129	29mm	58mm	CURTA/CORTA	Hex	583gr	25x
200130	30mm	62mm	CURTA/CORTA	Hex	625gr	25x
200132	32mm	62mm	CURTA/CORTA	Hex	666gr	20x
200133	33mm	62mm	CURTA/CORTA	Hex	716gr	25x
200134	34mm	62mm	CURTA/CORTA	Hex	666gr	12x
200136	36mm	65mm	CURTA/CORTA	Hex	750gr	12x
200138	38mm	65mm	CURTA/CORTA	Hex	808gr	20x

REF	⊕	⊥	TIPO	FACES/ CARAS	📏	📦
200140	40mm	65mm	CURTA/CORTA	Hex	835gr	20x
200141	41mm	70mm	CURTA/CORTA	Hex	883gr	12x
200142	42mm	70mm	CURTA/CORTA	Hex	906gr	16x
200146	46mm	75mm	CURTA/CORTA	Hex	1kg	10x
200150	50mm	75mm	CURTA/CORTA	Hex	1,06kg	16x
200155	55mm	83mm	CURTA/CORTA	Hex	1,3kg	10x
200156	56mm	83mm	CURTA/CORTA	Hex	1,3kg	8x
200160	60mm	87mm	CURTA/CORTA	Hex	1,6kg	10x
200163	63mm	87mm	CURTA/CORTA	Hex	1,7kg	8x
200165	65mm	90mm	CURTA/CORTA	Hex	1,7kg	8x
200170	70mm	90mm	CURTA/CORTA	Hex	1,9kg	8x
200175	75mm	90mm	CURTA/CORTA	Hex	2,4kg	6x
200180	80mm	90mm	CURTA/CORTA	Hex	2,65kg	6x

 Chave transmissão 1/2" 
 Llave transmisiones 1/2"



Info: Chaves que constam no jogo REF 3055
Info: Llaves contenidas en el juego REF 3055

REF	⊕	⊥	TIPO	FACES/ CARAS	📏	📦
128529	29mm	85mm	Transmissão/Transmisiones	BiHex	479gr	24x
128530	30mm	85mm	Transmissão/Transmisiones	BiHex	500gr	24x
128531	31mm	85mm	Transmissão/Transmisiones	BiHex	520gr	24x
128532	32mm	85mm	Transmissão/Transmisiones	BiHex	520gr	40x
128533	33mm	85mm	Transmissão/Transmisiones	BiHex	520gr	24x
128534	34mm	85mm	Transmissão/Transmisiones	BiHex	562gr	24x
128535	35mm	85mm	Transmissão/Transmisiones	BiHex	625gr	24x
128536	36mm	85mm	Transmissão/Transmisiones	BiHex	645gr	24x
128538	38mm	85mm	Transmissão/Transmisiones	BiHex	666gr	24x

Chave de caixa 1/4" con bit
 Llave de vaso 1/4" con punta



REF	⊕	ℓ	TIPO	FACES/ CARAS	📦	📄
14203	3mm	32mm	CURTO/CORTA	Hex	14gr	1x
14204	4mm	32mm	CURTO/CORTA	Hex	18gr	250x
14205	5mm	32mm	CURTO/CORTA	Hex	14gr	1x
14216	6mm	32mm	CURTO/CORTA	Hex	14gr	500x
14224	7mm	32mm	CURTO/CORTA	Hex	14gr	500x
14225	8mm	32mm	CURTO/CORTA	Hex	22gr	250x
14308	T8	37mm	CURTO/CORTA	Torx	14gr	400x
14309	T9	32mm	CURTO/CORTA	Torx	20gr	250x
14310	T10	32mm	CURTO/CORTA	Torx	18gr	400x
14315	T15	32mm	CURTO/CORTA	Torx	18gr	500x
14316	T20	32mm	CURTO/CORTA	Torx	20gr	500x
14325	T25	32mm	CURTO/CORTA	Torx	14gr	500x
14327	T27	32mm	CURTO/CORTA	Torx	10gr	1x
14330	T30	32mm	CURTO/CORTA	Torx	16gr	600x
14331	T40	32mm	CURTO/CORTA	Torx	20gr	400x
235510	TS10H	32mm	CURTO/CORTA	Torx TS	16,4gr	1x
235515	TS15H	32mm	CURTO/CORTA	Torx TS	16,4gr	1x
235520	TS20H	32mm	CURTO/CORTA	Torx TS	16,4gr	1x
235525	TS25H	32mm	CURTO/CORTA	Torx TS	16,4gr	1x
235527	TS27H	32mm	CURTO/CORTA	Torx TS	16,4gr	1x
235530	TS30H	32mm	CURTO/CORTA	Torx TS	16,4gr	1x
235540	TS40H	32mm	CURTO/CORTA	Torx TS	16,4gr	1x
235545	TS45H	32mm	CURTO/CORTA	Torx TS	16,4gr	1x
235550	TS50H	32mm	CURTO/CORTA	Torx TS	22gr	400x

REF	⊕	ℓ	TIPO	FACES/ CARAS	📦	📄
14235	3,5mm	32mm	CURTO/CORTA	Fenda/Plana	9gr	1x
14240	4mm	32mm	CURTO/CORTA	Fenda/Plana	13gr	1x
14255	5,5mm	32mm	CURTO/CORTA	Fenda/Plana	14gr	1x
14260	6mm	32mm	CURTO/CORTA	Fenda/Plana	15gr	1x
14270	7mm	32mm	CURTO/CORTA	Fenda/Plana	15gr	1x
14308H	T8H	32mm	CURTO/CORTA	Torx furado/ inviolable	10gr	1x
14309H	T9H	32mm	CURTO/CORTA	Torx furado/ inviolable	14gr	1x
14310H	T10H	32mm	CURTO/CORTA	Torx furado/ inviolable	14gr	1x
14315H	T15H	32mm	CURTO/CORTA	Torx furado/ inviolable	14gr	1x
14316H	T20H	32mm	CURTO/CORTA	Torx furado/ inviolable	16gr	100x
14325H	T25H	32mm	CURTO/CORTA	Torx furado/ inviolable	14gr	500x
14327H	T27H	32mm	CURTO/CORTA	Torx furado/ inviolable	14gr	1x
14330H	T30H	32mm	CURTO/CORTA	Torx furado/ inviolable	18gr	200x
14111	PH1	32mm	CURTO/CORTA	Phillips, Pozidriv	15gr	1x
14112	PH2	32mm	CURTO/CORTA	Phillips, Pozidriv	14gr	1x
14116	PH3	32mm	CURTO/CORTA	Phillips, Pozidriv	20gr	1x
14113	PZ1	32mm	CURTO/CORTA	Phillips, Pozidriv	14gr	1x
14114	PZ2	32mm	CURTO/CORTA	Phillips, Pozidriv	15gr	1x
14115	PZ3	32mm	CURTO/CORTA	Phillips, Pozidriv	15gr	1x

Chave de caixa 1/2" con bit
 Llave de vaso 1/2" con punta



REF	⊕	ℓ	TIPO	FACES/ CARAS	📦	📄
126004	4mm	60mm	CURTO/CORTA	Hex	77gr	1x
126005	5mm	60mm	CURTO/CORTA	Hex	75gr	200x
126006	6mm	60mm	CURTO/CORTA	Hex	77gr	200x
126007	7mm	60mm	CURTO/CORTA	Hex	80gr	100x
126008	8mm	60mm	CURTO/CORTA	Hex	80gr	100x
126010	10mm	60mm	CURTO/CORTA	Hex	100gr	100x
125511	11mm	60mm	CURTO/CORTA	Hex	200gr	100x
126012	12mm	60mm	CURTO/CORTA	Hex	100gr	200x
126014	14mm	60mm	CURTO/CORTA	Hex	110gr	1x
126017	17mm	60mm	CURTO/CORTA	Hex	170gr	1x
126019	19mm	60mm	CURTO/CORTA	Hex	200gr	100x
1261004	4mm	100mm	LONGO/LARGA	Hex	100gr	100x
1261005	5mm	100mm	LONGO/LARGA	Hex	100gr	100x

REF	⊕	ℓ	TIPO	FACES/ CARAS	📦	📄
1261006	6mm	100mm	LONGO/LARGA	Hex	100gr	1x
1261008	8mm	100mm	LONGO/LARGA	Hex	100gr	1x
1261010	10mm	100mm	LONGO/LARGA	Hex	100gr	1x
1261111	11mm	110mm	LONGO/LARGA	Hex	140gr	50x
1261012	12mm	100mm	LONGO/LARGA	Hex	135gr	80x
1261014	14mm	100mm	LONGO/LARGA	Hex	160gr	100x
1261405	5mm	140mm	LONGO/LARGA	Hex	100gr	1x
1261406	6mm	140mm	LONGO/LARGA	Hex	100gr	1x
1261408	8mm	140mm	LONGO/LARGA	Hex	120gr	1x
1261410	10mm	140mm	LONGO/LARGA	Hex	140gr	100x
1261412	12mm	140mm	LONGO/LARGA	Hex	197gr	1x
126020	T20	60mm	CURTO/CORTA	Torx	60gr	1x
126025	T25	60mm	CURTO/CORTA	Torx	60gr	1x

REF	⊕	∓	TIPO	FACES/ CARAS	⚖	📄
126027	T27	60mm	CURTO/CORTA	Torx	60gr	1x
126030	T30	60mm	CURTO/CORTA	Torx	81gr	200x
126040	T40	60mm	CURTO/CORTA	Torx	75gr	100x
126045	T45	60mm	CURTO/CORTA	Torx	80gr	250x
126050	T50	60mm	CURTO/CORTA	Torx	60gr	300x
126055	T55	60mm	CURTO/CORTA	Torx	100gr	100x
126060	T60	60mm	CURTO/CORTA	Torx	80gr	1x
1261020	T20	100mm	LONGO/LARGA	Torx	80gr	1x
1261025	T25	100mm	LONGO/LARGA	Torx	80gr	100x
1261027	T27	100mm	LONGO/LARGA	Torx	130gr	100x
1261030	T30	100mm	LONGO/LARGA	Torx	120gr	100x
1261040	T40	100mm	LONGO/LARGA	Torx	97gr	100x
1261045	T45	100mm	LONGO/LARGA	Torx	85gr	1x
1261050	T50	100mm	LONGO/LARGA	Torx	90gr	1x
1261055	T55	100mm	LONGO/LARGA	Torx	110gr	1x
1261060	T60	100mm	LONGO/LARGA	Torx	150gr	150x
1261070	T70	100mm	LONGO/LARGA	Torx	260gr	1x
1261440	T40	140mm	LONGO/LARGA	Torx	190gr	100x
1261445	T45	140mm	LONGO/LARGA	Torx	200gr	1x
1261450	T50	140mm	LONGO/LARGA	Torx	200gr	150x
1261455	T55	140mm	LONGO/LARGA	Torx	139gr	1x
1261460	T60	140mm	LONGO/LARGA	Torx	260gr	1x
1261470	T70	140mm	LONGO/LARGA	Torx	280gr	1x
12106	M6	60mm	CURTO/CORTA	xzn	70gr	1x
12108	M8	60mm	CURTO/CORTA	xzn	70gr	1x
12109	M9	60mm	CURTO/CORTA	xzn	200gr	1x
12110	M10	60mm	CURTO/CORTA	xzn	70gr	1x
12112	M12	60mm	CURTO/CORTA	xzn	80gr	1x
12114	M14	60mm	CURTO/CORTA	xzn	80gr	1x
12117	M17	60mm	CURTO/CORTA	xzn	100gr	100x
1211005	M5	100mm	LONGO/LARGA	xzn	100gr	1x
1211006	M6	100mm	LONGO/LARGA	xzn	100gr	1x
1211008	M8	100mm	LONGO/LARGA	xzn	100gr	1x
1211009	M9	100mm	LONGO/LARGA	xzn	100gr	60x
1211010	M10	100mm	LONGO/LARGA	xzn	100gr	1x

REF	⊕	∓	TIPO	FACES/ CARAS	⚖	📄
1211012	M12	100mm	LONGO/LARGA	xzn	100gr	1x
1211014	M14	100mm	LONGO/LARGA	xzn	100gr	1x
1211016	M16	100mm	LONGO/LARGA	xzn	100gr	1x
1211405	M5	140mm	LONGO/LARGA	xzn	100gr	1x
1211406	M6	140mm	LONGO/LARGA	xzn	100gr	1x
1211408	M8	140mm	LONGO/LARGA	xzn	111gr	100x
12109L	M9	140mm	LONGO/LARGA	xzn	110gr	1x
1211410	M10	140mm	LONGO/LARGA	xzn	147gr	100x
1211412	M12	140mm	LONGO/LARGA	xzn	110gr	1x
1211414	M14	140mm	LONGO/LARGA	xzn	113gr	1x
12304	R4	55mm	CURTO/CORTA	ribe	63gr	1x
12305	R5	55mm	CURTO/CORTA	ribe	60gr	1x
12306	R6	55mm	CURTO/CORTA	ribe	70gr	1x
12307	R7	55mm	CURTO/CORTA	ribe	70gr	1x
12308	R8	55mm	CURTO/CORTA	ribe	100gr	100x
12309	R9	55mm	CURTO/CORTA	ribe	87gr	200x
12310	R10	55mm	CURTO/CORTA	ribe	78gr	160x
12312	R12	55mm	CURTO/CORTA	ribe	100gr	100x
12313	R13	55mm	CURTO/CORTA	ribe	85gr	1x
12314	R14	55mm	CURTO/CORTA	ribe	112gr	1x
123104	R4	100mm	LONGO/LARGA	ribe	120gr	1x
123105	R5	100mm	LONGO/LARGA	ribe	120gr	1x
123106	R6	100mm	LONGO/LARGA	ribe	120gr	1x
123107	R7	100mm	LONGO/LARGA	ribe	120gr	60x
123108	R8	100mm	LONGO/LARGA	ribe	120gr	1x
123109	R9	100mm	LONGO/LARGA	ribe	120gr	100x
123110	R10	100mm	LONGO/LARGA	ribe	120gr	1x
123112	R12	100mm	LONGO/LARGA	ribe	135gr	200x
123113	R13	100mm	LONGO/LARGA	ribe	155gr	100x
123114	R14	100mm	LONGO/LARGA	ribe	179gr	100x
2101	R9	140mm	LONGO/LARGA	ribe	140gr	250x
1261208	8mm	120mm	LONGO/LARGA	6x	120gr	100x
1261250	T50	120mm	LONGO/LARGA	torx	120gr	100x
1211210	M10	120mm	LONGO/LARGA	xzn	120gr	100x
1211410R	M10	140mm	LONGO/LARGA	xzn	140gr	100gr

 Régua para chaves de caixa 1/4" 14 peças
 Guía para vasos 1/4" 14 piezas



REF	↔	⚖	📄
1414	350mm	220gr	100x

 Régua 13 chaves de caixa 1/4" hexagonais
 Juego 13 llaves de vaso 1/4" hexagonales 



  Medidas: 4, 4.5, 5, 5.5, 6, 7, 8, 9, 10, 11, 12, 13, 14mm

REF	↔	⚖	📄
1415	350mm	270gr	1x

 Régua 8 chaves de caixa 1/4" longas hexagonais 
 Juego con 8 llaves de vaso 1/4" largas hexagonales



Medidas: 6, 7, 8, 9, 10, 11, 12, 13mm

REF



1416

350mm

385gr

1x

 Régua 13 chaves caixa 1/4" curtas bihexagonais 
 Juego 13 llaves vaso 1/4" cortas bihexagonales



Medidas: 4, 4.5, 5, 5.5, 6, 7, 8, 9, 10, 11, 12, 13, 14mm

REF



1419

350mm

272gr

1x

 Régua 8 chaves de caixa 1/4" longas bihexagonais 
 Juego 8 llaves de vaso 1/4" largas bihexagonales



Medidas: 6, 7, 8, 9, 10, 11, 12, 13mm

REF



1420

350mm

291gr

1x

 Régua com 7 chaves de caixa 1/4" torx fêmea 
 Juego con 7 llaves de vaso 1/4" torx hembra



Medidas: E4, E5, E6, E7, E8, E10, E11

REF



1417

350mm

274gr

1x

 Régua para 12 chaves de caixa 1/2"
 Guía para vasos 1/2" 12 piezas



REF



1412

350mm

800gr

100x

 Régua com 10 chaves de caixa 1/2" hexagonais 
 Juego con 10 llaves de vaso 1/2" hexagonales



Medidas: 10, 11, 13, 14, 15, 16, 17, 19, 20, 22mm

REF



1233

350mm

800gr

1x

 Régua com 10 chaves de caixa 1/2" bihexagonais 
 Juego con 10 llaves de vaso 1/2" bihexagonales



Medidas: 10, 11, 13, 14, 15, 16, 17, 19, 20, 22mm

REF



1234

350mm

800gr

1x

Régua com 9 chaves de caixa 1/2" longas hexagonais
Juego con 9 llaves de vaso 1/2" largas hexagonales



Medidas: 10, 13, 14, 17, 19, 21, 22, 24, 27mm

REF	↔	📏	📄
1237	350mm	1,7kg	1x

Régua com 9 chaves de caixa 1/2" longas bihexagonais
Juego con 9 llaves de vaso 1/2" largas bihexagonales



Medidas: 10, 13, 14, 17, 19, 21, 22, 24, 27mm

REF	↔	📏	📄
1238	350mm	1,7kg	1x

Régua com 9 chaves de caixa 1/2" torx fêmea
Juego con 9 llaves de vaso 1/2" torx hembra



Medidas: E10, E11, E12, E14, E16, E18, E20, E22, E24

REF	↔	📏	📄
1418	350mm	800gr	1x

Régua com 9 chaves de caixa 1/2" impacto
Juego con 9 llaves de vaso 1/2" impacto



Medidas: 10, 12, 14, 17, 19, 21, 22, 24, 27mm

REF	↔	📏	📄
1235	350mm	1,7kg	1x

Régua com 9 chaves de caixa 1/2" impacto longas
Juego con 9 llaves de vaso 1/2" impacto largas



Medidas: 10, 11, 13, 17, 19, 21, 22, 24, 27mm

REF	↔	📏	📄
1236	350mm	1,7kg	1x

-  Organizador chaves de caixa 1/4"
 Organizador llaves de vaso 1/4"



-  **Medidas encaixe:** 4, 4.5, 5, 5.5, 6, 7, 8, 9, 10, 11, 12, 13, 14, 15mm
Características: Segura e organiza as chaves de caixa curtas, longas e acessórios

 **Medidas de encaje:** 4, 4.5, 5, 5.5, 6, 7, 8, 9, 10, 11, 12, 13, 14, 15mm
Características: Segura y organiza las llaves de vaso cortas, largas y accesorios

REF		
4014	64gr	96x

-  Organizador chaves de caixa 3/8"
 Organizador llaves de vaso 3/8"



-  **Medidas encaixe:** 6, 7, 8, 9, 10, 11, 12, 13, 14, 15, 16,17, 18, 19, 20mm
Características: Segura e organiza as chaves de caixa curtas, longas e acessórios

 **Medidas de encaje:** 6, 7, 8, 9, 10, 11, 12, 13, 14, 15, 16,17, 18, 19, 20mm
Características: Segura y organiza las llaves de vaso cortas, largas y accesorios

REF		
4038	166gr	48x

-  Organizador chaves caixa 1/2"
 Organizador llaves vaso 1/2"



-  **Medidas encaixe:** 10, 11, 12, 13, 14, 15, 16, 17, 18, 19, 20, 21, 22, 23, 24, 25, 27mm
Características: Segura e organiza as chaves de caixa curtas, longas e acessórios

 **Medidas de encaje:** 10, 11, 12, 13, 14, 15, 16, 17, 18, 19, 20, 21, 22, 23, 24, 25, 27mm
Características: Segura y organiza las llaves de vaso cortas, largas y accesorios

REF		
4012	270gr	48x

-  Kit aumentos 1/4", 3/8", 1/2" com íman
 Juego alargaderas 1/4", 3/8", 1/2" con imán



REF			
4123	37,43,60mm	225gr	20x

 Cardan universal 1/4"
 Articulación universal 1/4"



 Ângulo: 90°-50°

 Ángulo: 90°-50°

REF	↕	⚖️	📦
4521	35mm	32gr	250x

 Cardan universal 1/2"
 Articulación universal 1/2"



REF	↕	⚖️	📦
4541	72mm	139gr	1x

 Aumento 1/4"
 Alargadera 1/4"



REF	↔	⚖️	📦
4050	50mm	20gr	1x
4100	100mm	40gr	1x

 Aumento 3/8"
 Alargadera 3/8"



REF	↔	⚖️	📦
4380	125mm	110gr	1x

 Cardan universal 3/8"
 Articulación universal 3/8"



REF	↕	⚖️	📦
4542	57mm	58gr	400x

 Cardan universal 1"
 Articulación universal 1"



REF	⚖️	📦
100005	1,2kg	25x

 Aumento flexível 1/4"
 Alargadera flexible 1/4"



REF	↔	⚖️	📦
4145	145mm	40gr	1x

-  Aumento 1/2" com ângulo 15°
 Alargadera 1/2" con ángulo 15°



REF	↕	⚖	📦
4120	50mm	105gr	1x

-  Aumento quadra 1/2" com ímã
 Alargadera cuadrado 1/2" con imán



REF	↕	⚖	📦
4122	85mm	58gr	1x

-  Jogo de 3 aumentos 1/2"
 Juego de 3 alargaderas 1/2"



 Comprimento: 450, 600, 750mm

 Longitud: 450, 600, 750mm

REF	⚖	📦
2237	450gr	1x

-  Aumento 1"
 Alargadera 1"



REF	↔	⚖	📦
100002	200mm	1,19kg	10x
100003	400mm	2,14kg	5x

-  Aumento impacto 1/2" 500mm
 Alargadera impacto 1/2" 500mm

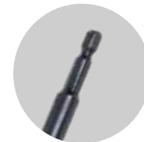
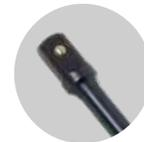

REF	↔	⚖	📦
12500	500mm	310gr	80x

-  Aumento impacto 1/4" 500mm
 Alargadera impacto 1/4" 500mm



REF	↔	⚖	📦
14500	500mm	295gr	80x

-  Aumentos quadra 1/2"
 Alargaderas cuadrado 1/2"



REF	↔	📏	📦
4125	125mm	220gr	1x
4251	250mm	400gr	50x
4252	450mm	675gr	20x
4253	600mm	933gr	15x
4254	750mm	1,17kg	15x

-  Aumentos 3/4"
 Alargaderas 3/4"



REF	↔	📏	📦
34022	100mm	400gr	1x
34023	200mm	700gr	1x
34024	400mm	700gr	10x

-  Aumento impacto 1"
 Alargadera impacto 1"



REF	↔	📏	📦
200006	125mm	1kg	15x
200007	250mm	1,9kg	10x
200008	400mm	2,1kg	5x

-  Braço corredeço 1/4"
 Mango corredizo 1/4"



REF	↔	📏	📦
8314	115mm	44gr	1x

-  Punho t corredeço 3/4"
 Mango t corredizo 3/4"



REF	↔	📏	📦
3420	500mm	1,4kg	12x

-  Braço t correção impacto 1"
 Mango t corredizo impacto 1"



REF	↔	📏	📦
200009	510mm	2,3kg	5x

-  Braço correção 1/2" DR
 Mango corredizo 1/2" DR



Cabeça corr. / Cabeza corr.



REF 12443

REF	↔	📏	📦
8312	300mm	428gr	50x

-  Braço t correção 1"
 Brazo t corredizo 1"



REF	↔	📏	📦
100004	510mm	2,36kg	5x

-  Cabo articulado 1/2"
 Mango articulado 1/2"



Kit reparação / Kit reparación



REF 8112S

REF	↔	📏	📦
8112	600mm	1,79kg	10x

-  Cabo articulado 3/4"
 Mango articulado 3/4"



Kit reparação / Kit reparación



REF 6113S

REF	↔	📏	📦
6113	990mm	3,15kg	4x

-  Punho quadra macho 1/4"
 Mango cuadrado macho 1/4"



REF	↔	📏	📦
14150	150mm	9gr	1x

 Roquete reversível 1/4"
 Carraca reversible 1/4"



Kit reparação / Kit reparación



REF 12014K

REF	↔	🔩	📄
12014	154mm	172gr	50x

 Roquete reversível 1/4" longo 304mm
 Carraca reversible 1/4" larga 304mm



REF	↔	🔩	📄
12015	304mm	297gr	48x

 Roquete reversível 1/4" articulado longo 304mm
 Carraca reversible 1/4" articulado largo 304mm



REF	↔	🔩	📄
12018	304mm	281gr	48x

 Roquete 1/4" gearless
 Carraca 1/4" gearless



 **Características:**

Menos de 1° de arco de rotação
Aperta instantaneamente para maior precisão
Engate magnético do rolo
Desbloqueio rápido da chave
Corpo CR-V niquelado

 **Características:**

Menos de 1° de arco de rotación
Apriete instantáneo para mayor precisión
Acoplamiento magnético de rodillos
Cierre rápido con llave
Cuerpo CR-V niquelado

REF	🔩	📄
1132	225gr	16x

 Roquete reversível 3/8"
 Carraca reversible 3/8"



Kit reparação / Kit reparación



REF 12038K

REF	↔	🔩	📄
12038	193mm	380gr	50x

 Roquete reversível 3/8" longo 457mm
 Carraca reversible 3/8" largo 457mm



REF	↔	🔩	📄
12039	457mm	812gr	24x

-  Roquete reversível 3/8" articulado longo 457mm
 Carraca reversible 3/8" articulado largo 457mm



REF	↔	⚙️	📦
12040	457mm	704gr	24x

-  Roquete 3/8" gearless
 Carraca 3/8" gearless



-  **Características:**
 Menos de 1° de arco de rotação
 Aperta instantaneamente para maior precisão
 Engate magnético do rolo
 Desbloqueio rápido da chave
 Corpo CR-V niquelado

-  **Características:**
 Menos de 1° de arco de rotación
 Apriete instantáneo para mayor precisión
 Acoplamiento magnético de rodillos
 Cierre rápido con llave
 Cuerpo CR-V niquelado

REF	⚙️	📦
1131	387,5gr	16x

-  Roquete reversível 1/2"
 Carraca reversible 1/2"



Kit reparação / Kit reparación



REF 12012K

REF	↔	⚙️	📦
12012	245mm	600gr	20x

-  Quadra para roquete 1/2"
 Cuadrado para llave de carraca 1/2"



REF	↔	⚙️	📦
12012Q	35mm	40gr	250x

-  Roquete reversível 1/2" longo 609mm
 Carraca reversible 1/2" largo 609mm



REF	↔	⚙️	📦
12013	609mm	1,27kg	12x

Roquete reversível 1/2" articulado longo 609mm
Carraca reversible 1/2" articulado largo 609mm



REF	↔	📏	📦
12017	609mm	1,29kg	12x

Roquete 1/2" gearless
Carraca 1/2" gearless



Características:
Menos de 1° de arco de rotação
Aperta instantaneamente para maior precisão
Engate magnético do rolo
Desbloqueio rápido da chave
Corpo CR-V niquelado

Características:
Menos de 1° de arco de rotación
Apriete instantáneo para mayor precisión
Acoplamiento magnético de rodillos
Cierre rápido con llave
Cuerpo CR-V niquelado

REF	📏	📦
1133	700gr	16x

Roquete reversível 3/4"
Carraca reversible 3/4"



Kit reparação / Kit reparación



REF 34021K

REF	↔	📏	📦
34021	500mm	2,7kg	10x

Roquete reversível 1"
Carraca reversible 1"



Kit reparação / Kit reparación



REF 100001K

REF	↔	📏	📦
100001	510mm	4,8kg	5x

Kit mini roquetes 1/4", 3/8", 1/2" 3 peças
Kit mini carracas 1/4", 3/8", 1/2" 3 piezas



Medidas: 1/4" 85mm, 3/8" 100mm, 1/2" 130mm (72D)

REF	📏	📦
8557	840kg	12x

 Chaves luneta roquete multi-ângulos 9pcs
 Llaves de estrella con carraca multiangular 9pzs



 **Características:**
 Punho articulado de alta resistência possui 2 articulações de bloqueio para até 34 posições diferentes da chave e acesso a espaços de difícil alcance
 Extremidades da chave intercambiáveis possuem 90 dentes de engrenagem para um arco de oscilação de 3.5°
 Liga de aço 5140 para uma resistência e durabilidade superiores
 Níquel cromado para resistência à ferrugem e à corrosão

 **Características:**
 Mango articulado resistente con 2 articulaciones de bloqueo para hasta 34 posiciones de llave diferentes y acceso a espacios de difícil acceso
 Extremos de llave intercambiables con 90 dientes para un arco de oscilación de 3.5°
 Acero de aleación 5140 para una resistencia y durabilidad superiores
 superior
 Níquel cromado para mayor resistencia al óxido y la corrosión

REF

1130



1,666kg



6x

 Chaves boca-luneta roquete gearless 8pcs
 Juego 8 llaves combinadas gearless



8x



8, 10, 12, 13, 14, 15, 17, 19mm

 **Características:**
 Aperta um parafuso num 1° de arco de rotação
 Agarra instantaneamente para maior precisão
 Rolamentos de rolos em aço cromado
 Corpo CR-V revestido a Nickel

 **Características**
 Gira una fijación en tan sólo 1° de arco de giro
 Agarre instantáneo para mayor precisión
 Rodamientos de rodillos de acero al cromo
 Cuerpo CR-V niquelado

REF

1134



1,10kg



12x

 Aumento 3/8" F x 1/2" M
 Adaptador 3/8" H x 1/2" M



REF		
14340	50gr	200x

 Aumento 1/4" F x 3/8" M
 Adaptador 1/4" H x 3/8" M



REF		
14230	50gr	200x

 Redução 3/8" F x 1/4" M
 Reductor 3/8" H x 1/4" M



REF		
14320	24gr	250x

 Aumento de impacto 1/4" F x 3/8" M
 Adaptador de impacto 1/4" H x 3/8" M



REF		
12432	21gr	1x

 Redução 1/2" F x 3/8" M
 Reductor 1/2" H x 3/8" M



REF		
12430	105gr	200x

 Aumento 1/2" F x 3/4" M
 Adaptador 1/2" H x 3/4" M



REF		
12460	125gr	100x

 Redução 3/4" F x 1/2" M
 Reductor 3/4" H x 1/2" M



  **Aviso:** Dadas as especiais condições de trabalho deste produto não garantimos a contra rotura do quadrado macho

  **Advertencia:** Dadas las condiciones especiales de trabajo deste producto no garantizamos la contra rotura del cuadrado macho

REF		
34640	100gr	100x

-  Redução de impacto 3/8" F x 1/4" M
 Reductor de impacto 3/8" H x 1/4" M



REF		
14321	31gr	1x

-  Aumento de impacto 1/2" F x 3/4" M
 Adaptador de impacto 1/2" H x 3/4" M



REF		
34613	134gr	120x

-  Aumento de impacto 3/8" F x 1/2" M
 Adaptador de impacto 3/8" H x 1/2" M



REF		
34615	48gr	100x

-  Redução de impacto 1/2" F x 3/8" M
 Reductor de impacto 1/2" H x 3/8" M



REF		
34614	55gr	1x

-  Redução de impacto 3/4" F x 1/2" M
 Reductor de impacto 3/4" H x 1/2" M



-   **Aviso:** Dadas as especiais condições de trabalho deste produto não garantimos a contra rotura do quadrado macho
  **Advertencia:** Dadas las condiciones especiales de trabajo deste producto no garantizamos la contra rotura del cuadrado macho

REF		
34612	212gr	40x

-  Redução de impacto 1" F x 3/4" M
 Reductor de impacto 1" H x 3/4" M



-   **Aviso:** Dadas as especiais condições de trabalho deste produto não garantimos a contra rotura do quadrado macho
  **Advertencia:** Dadas las condiciones especiales de trabajo deste producto no garantizamos la contra rotura del cuadrado macho

REF		
34641	650gr	40x

 Aumento de impacto 3/4" F x 1" M
 Adaptador de impacto 3/4" H x 1" M



REF		
34642	500gr	20x

 Redução de impacto 1" F x 3/4" M 250mm
 Reductor de impacto 1" H x 3/4" M 250mm



REF		
200010	1,1kg	10x

 Jogo reduções 6pcs
 Juego adaptadores 6pzs



 **Composição:** 1/4" F x 3/8" M; 3/8" F x 1/4" M, 3/8" F x 1/2" M, 1/2" F x 3/8" M, 1/2" F x 3/4" M, 3/4" F x 1/2" M

 **Composición:** 1/4" H x 3/8" M; 3/8" H x 1/4" M, 3/8" H x 1/2" M, 1/2" H x 3/8" M, 1/2" H x 3/4" M, 3/4" H x 1/2" M

REF		
8199	500gr	20x

 Jogo reduções impacto 6pcs
 Juego adaptadores impacto 6pzs



 **Composição:** 1/4" F x 3/8" M; 3/8" F x 1/4" M, 3/8" F x 1/2" M, 1/2" F x 3/8" M, 1/2" F x 3/4" M, 3/4" F x 1/2" M

 **Composición:** 1/4" H x 3/8" M; 3/8" H x 1/4" M, 3/8" H x 1/2" M, 1/2" H x 3/8" M, 1/2" H x 3/4" M, 3/4" H x 1/2" M

REF		
8200	550gr	20x

 Kit chaves longas 1/4" torx interior E4-E10 6 peças
 Kit llaves largas 1/4" torx Interior E4-E10 6 piezas

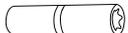

6x		E4, E5, E6, E7, E8, E10
----	--	-------------------------

REF		
6104	205gr	20x

-  Kit chaves longas 3/8" torx interior E8-E14 5 peças
 Kit llaves largas 3/8" torx interior E8-E14 5 piezas

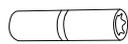

5x		E8, E10, E11, E12, E14
----	--	------------------------

REF		
6105	350gr	20x

-  Kit 9 chaves de caixa 1/2" torx interior E10-E24 
 Kit 9 llaves de vaso 1/2" torx interior E10-E24



9x		E10, E11, E12, E14, E16, E18, E20, E22, E24
----	--	---

REF			
6103	78mm	1,48kg	10x

-  Kit 6 chaves 1/2" longas torx interior E10-E20 
 Kit 6 llaves 1/2" largas torx interior E10-E20



6x		E10, E12, E14, E16, E18, E20
----	--	------------------------------

REF			
1440	140mm	2,05kg	10x

-  Kit 9 chaves 1/2" com bit torx T25-T70 
 Kit 9 llaves 1/2" con punta torx T25-T70



9x		T25, T27, T30, T40, T45, T50, T55, T60, T70
----	---	---

REF			
6102	60mm	550gr	12x

-  Kit 8 chaves 1/2" com bit torx longo T27-T70 
 Kit 8 llaves 1/2" con punta torx largo T27-T70



8x		T27, T30, T40, T45, T50, T55, T60, T70
----	--	--

REF			
6101	100mm	800gr	10x

 Kit 8 chaves 1/2" com bit hexagonal longo 4-17mm
 Kit 8 llaves 1/2" con punta hexagonal larga 4-17mm



8x		4, 5, 6, 8, 10, 12, 14, 17mm
----	--	------------------------------

REF	↕		
6100	100mm	1,55kg	10x

 Kit 11 chaves 1/2" com bit hexagonal 4-19mm
 Kit 11 llaves 1/2" con punta hexagonal 4-19mm



11x		4, 5, 6, 7, 8, 9, 10, 12, 14, 17, 19mm
-----	--	--

REF	↕		
6099	60mm	800gr	10x

 Kit chaves H14-H23 3/4" 6 peças
 Kit llaves H14-H23 3/4" 6 piezas



6x		H14, H17, H19, H21, H22, H23mm
----	---	--------------------------------

REF	↕		
2126	60mm	1,63kg	10x

 Kit chaves torx plus exterior 6f 19 peças
 Kit de vasos torx plus externos de 19 piezas



19x		(5x) 6f/pt 1/4" 24mm: EP4, EP5, EP6, EP7, EP8 (5x) 6f/pt 3/8": EP10 24mm, EP11 24mm, EP12 36mm, EP14 36mm, EP16 36mm (8x) 6f/pt 1/2": EP18 36mm, EP20 36mm, EP22 44mm, EP24 44mm, EP26 44mm, EP28 44mm, EP30 44mm, EP32 44mm (1x) 5f/pt 1/2" 24mm: EP8.8 - para o parafuso da tampa da bateria Tesla / para el tornillo de la tapa de la batería Tesla.
-----	--	--

REF	↕		
6106	24/36/44mm	1,2kg	10x

 Kit chaves torx plus exterior 5f 16pcs EP6-EP32
 Kit de vasos torx plus externos de 16 piezas 5pt EP6-EP32



16x		(5x) 1/4" 25mm: EPR, 7EPR, 8EPR, 10EPR, 11EPR (5x) 3/8" 37mm: 12EPR, 14EPR, 16EPR, 18EPR, 20EPR (6x) 1/2" 45mm: 22EPR, 24EPR, 26EPR, 28EPR, 30EPR, 32EPR
-----	--	--

REF	↕		
6107	25/37/45mm	1,33kg	20x

 Kit 9 chaves 1/2" impacto xzn M4-M16
 Kit 9 llaves 1/2" impacto xzn M4-M16



9x		M4, M5, M6, M8, M9, M10, M12, M14, M16
----	--	--

REF	∓	⚖	📦
6095	78mm	1,13kg	10x

 Kit 9 chaves 1/2" impacto ribe R5-R14
 Kit 9 llaves 1/2" impacto ribe R5-R14



9x		R5, R6, R7, R8, R9, R10, R12, R13, R14
----	--	--

REF	∓	⚖	📦
6096	78mm	1,13kg	10x

 Kit 8 chaves 1/2" impacto hexagonais 5-19mm
 Kit 8 llaves 1/2" impacto hexagonales 5-19mm



8x		5, 6, 8, 10, 12, 14, 17, 19mm
----	--	-------------------------------

REF	∓	⚖	📦
6097	78mm	1,15kg	10x

 Kit 9 chaves 1/2" impacto torx T20-T70
 Kit 9 llaves 1/2" impacto torx T20-T70



9x		T20, T25, T30, T40, T45, T50, T55, T60, T70
----	--	---

REF	∓	⚖	📦
6098	78mm	1,3kg	10x

 Kit chaves caixa com bit xzn 1/2" 26 peças
 Kit llaves vaso con punta xzn 1/2" 26 piezas

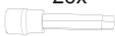

 26x	55mm	1/2": M5, M6, M8, M9, M10, M12, M14, M16
	100mm	1/2": M5, M6, M8, M9, M10, M12, M14
	140mm	1/2": M5, M6, M8, M9, M10, M12, M14
	200mm	1/2": M8, M10, M12, M14

REF		
6026	4,25kg	4x

 Jogo chaves caixa com bit hex 1/2" 30 peças
 Juego llaves vaso con punta hex 1/2" 30 piezas

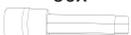

 30x	55mm	1/2": H5, H6, H7, H8, H10, H12, H14, H17, H19
	100mm	1/2": H5, H6, H7, H8, H10, H11, H12, H13
	140mm	1/2": H5, H6, H7, H8, H10, H12, H14
	200mm	1/2": H5, H6, H7, H8, H10, H12

REF		
6030	4,25kg	4x

 Kit chaves caixa com bit torx 1/2" 32 peças
 Kit llaves vaso con punta torx 1/2" 32 piezas

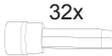

 32x	55mm	1/2": T20, T25, T27, T30, T40, T45, T50, T55, T60, T70
	100mm	1/2": T20, T25, T27, T30, T40, T45, T50, T55, T60, T70
	140mm	1/2": T40, T45, T50, T55, T60, T70
	200mm	1/2": T40, T45, T50, T55, T60, T70

REF

6032



4,25kg



4x

 Kit chaves caixa com bit 1/2" 88 peças
 Kit llaves vaso con punta 1/2" 88 piezas

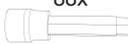

 88x	55mm	 1/2": M5, M6, M8, M9, M10, M12, M14, M16
	55mm	 1/2": H5, H6, H7, H8, H10, H12, H14, H17, H19
	55mm	 1/2": T20, T25, T27, T30, T40, T45, T50, T55, T60, T70
	100mm	 1/2": M5, M6, M8, M9, M10, M12, M14
	100mm	 1/2": H5, H6, H7, H8, H10, H11, H12, H13
	100mm	 1/2": T20, T25, T27, T30, T40, T45, T50, T55, T60, T70
	140mm	 1/2": M5, M6, M8, M9, M10, M12, M14
	140mm	 1/2": H5, H6, H7, H8, H10, H12, H14
	140mm	 1/2": T40, T45, T50, T55, T60, T70
	200mm	 1/2": M8, M10, M12, M14
	200mm	 1/2": H5, H6, H7, H8, H10, H12
	200mm	 1/2": T40, T45, T50, T55, T60, T70

REF

6088



13,3kg



1x

 Jogo chaves de caixa 1/4" 46 peças
 Juego llaves de vaso 1/4" 46 piezas

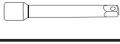

13x		1/4": 4, 4.5, 5, 5.5, 6, 7, 8, 9, 10, 11, 12, 13, 14 mm
6x	 	T10, T15, T20, T25, T30, T40
6x	 	3, 4, 5, 6, 7, 8mm
4x		1.27, 1.5, 2, 2.5mm
3x	 	PZ1, PZ2, PZ3
3x	 	PH1, PH2, PH3
3x	 	4, 5.5, 7mm
2x		50mm, 100mm
1x		
1x		72D
1x		115mm
1x		150mm
1x		1/4"
1x		30mm

REF

2046



1,43kg



10x

 Jogo chaves de caixa 35 peças 3/8"
 Juego llaves de vaso 35 piezas 3/8"

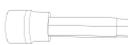

13x		3/8": 6, 7, 8, 9, 10, 11, 12, 13, 14, 15, 16, 17, 18, 19, 20, 21, 22, 24mm
10x		3/8": 8, 9, 10, 11, 12, 13, 14, 15, 17, 19mm
1x		
2x		75, 250mm
1x		72D
1x		
2x		16, 21mm

REF

2035



3,44kg



5x

 Kit chaves de caixa 110 peças 1/4", 1/2"

 Kit llaves de vaso 110 piezas 1/4", 1/2"

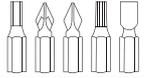
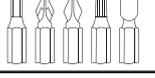
17x			1/2": 10, 11, 12, 13, 14, 15, 16, 17, 18, 19, 20, 21, 22, 24, 27, 30, 32mm
5x			1/2": 14, 15, 17, 19, 22mm
8x			1/2": E10, E11, E12, E14, E16, E18, E20, E24
1x			
2x		125mm, 250mm	
1x		72D	
1x			
2x		16mm, 21mm	
1x			
17x		30mm: TX: 40, 45, 50, 55, 60; PH: 3,4; PZ: 3,4 FD:8,10,12; HEX: 7,8,10,12,14	
13x			1/4": 4, 4.5, 5, 5.5, 6, 7, 8, 9, 10, 11, 12, 13, 14mm
8x			1/4": 6, 7, 8, 9, 10, 11, 12, 13mm
1x			
2x		50mm, 100mm	
1x		72D	
1x		115mm	
1x		150mm	
4x			
1x			
5x			1/4": E4, E5, E6, E7, E8
18x		TX: 8, 10, 15, 20, 25, 27, 30; PH: 1, 2; PZ: 1, 2 FD: 4, 5.5, 7; HEX: 3, 4, 5, 6	

 REF
 21110



 7,6kg

 4x

 Kit chaves de caixa 219 peças 1/4", 3/8", 1/2"
 Kit llaves de vaso 219 piezas 1/4", 3/8", 1/2"

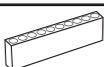

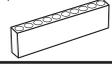
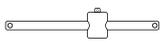
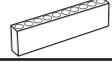
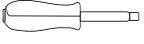
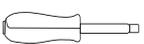
15x		1/2": 10-11-12-13-14-15-17-19-20 21-22-24-27-30-32mm
5x		1/2": 16-17-18-19-22mm
4x	 	1/2": E18-E20-E22-E24
2x		1/2": 16, 21mm
2x		125mm, 250mm
1x		1/2"
1x		1/2"
2x	 	T55-T60
1x		1/2" 72D
12x		8-9-10-11-12-13-14-15-16-17-18-19mm
1x		1/2" x 5/16"
1x		3/8": 18mm
10x		3/8": 10-11-12-13-14-15-16-17-18-19mm
6x		3/8": 10-11-12-13-14-15mm

5x	 	3/8": E8-E10-E12-E14-E16
1x		3/8": 125mm
1x		3/8"
1x		3/8" x 5/16"
1x		3/8" 72D
13x		1/4": 4-4.5-5-5.5-6-7-8-9-10-11-12-13-14mm
7x		1/4": 4-5-6-7-8-9-10mm
2x		1/4": 100mm, 50mm
5x	 	E4-E5-E6-E7-E8
1x		1/4"
1x		1/4": 115mm
1x		1/4" 72D
10x	 	1/4" (1.27-1.5-2)X2pc-2.5-3-4-5mm
1x		1/4"
1x		1/4" CRV - cromado prateado/plateado
1x		1/4" CRV
4x	 	1/4": 4, 5.5, 6.5, 7mm
3x	 	1/4": 1. 2. 3
8x	 	1/4": 8, 9, 10, 15, 20, 25, 27, 30
8x	 	1/4": 8. 9. 10. 15. 20. 25. 27. 30
4x	 	1/4": 3.4.5.6
3x	 	1/4": 1.2.3
30x	           	30mm: TX: 25,27x(2pcs), 30x(2pcs), 35x(2pcs), 40x(3pcs), 45x(2pcs), 50x(2pcs) H5.5, 6, 6, 7, 8, SL6, 6.5, 8, PH3, 4, PZ3, 4, M5, 6, 8, 10
44x	          	25mm: (4x) H3, H4, H5, H6, (4x) H3, H4, H5, H6 (com/con soporte) (2x) PH1, 2, (2x) PZ1, 2, (5x) T8, 10, 15, 20, 25 (10x) TT: 8.10x(2pcs). 15.20x(2pcs). 25x(2pcs). 40 (3x) M5, 6, 8, (3x) SL4, 5, 5.5, (3x) TRI-WING 1 2 3 (3x) TORQ 6, 8, 10, (2x) S1, 2, (3x) SL4 6 8

REF

2218



11kg



2x

-  Kit 9 chaves caixa 1/2" bihexagonais para transmissões
 Kit 9 llaves vaso 1/2" bihexagonales para transmisiones



9x			29, 30, 31, 32, 33, 34, 35, 36, 38mm
			PSA, VAG, BMW

REF

3055



4,6kg



4x

-  Kit chaves impacto 1/2" 40 peças
 Kit llaves impacto 1/2" 40 piezas



19x			9, 10, 11, 12, 13, 14, 15, 16, 17, 18, 19, 20, 21, 22, 23, 24, 26, 27, 30mm
19x			9, 10, 11, 12, 13, 14, 15, 16, 17, 18, 19, 20, 21, 22, 23, 24, 26, 27, 30mm
1x			
1x			125mm

REF

2124



8,2kg



2x

-  Kit chaves caixa 3/4" 12PT 21 peças
 Kit llaves vaso 3/4" 12PT 21 piezas

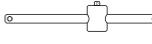

16x			19, 20, 22, 23, 24, 26, 27, 28, 30, 32, 34, 36, 38, 41, 46, 50mm
1x			3/4"
2x			100mm, 200mm
1x			500mm
1x			

REF

2122



12,5kg



1x

-  Kit chaves caixa 3/4" 6PT 21 peças
 Kit llaves vaso 3/4" 6PT 21 piezas

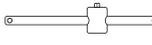

16x			19, 20, 22, 23, 24, 26, 27, 28, 30, 32, 34, 36, 38, 41, 46, 50mm
1x			3/4"
2x			100mm, 200mm
1x			500mm
1x			

REF

2123



11,5kg



1x

 Kit chaves caixa 21 peças 1" 6PT
 Kit llaves vaso 21 piezas 1" 6PT



1x		
1x		510mm
2x		200mm, 400mm
17x	 	36, 38, 41, 43, 45, 46, 48, 50, 54, 56, 57, 60, 63, 65, 70, 75, 80mm

REF		
100000	35,2kg	2x

 Kit chaves caixa impacto 1" 8 peças
 Kit llaves vaso impacto 1" 8 piezas



8x		CR-MO: 24, 27, 29, 30, 32, 33, 36, 38mm
----	--	---

REF		
200000	6kg	2x

 Alavanca de pneu para motos
 Palanca de neumáticos para motos



REF			
5406	370mm	281gr	48x

 Jogo de 4 alavancas 8", 12", 18", 24" reforçadas
 Juego de 4 palancas 8", 12", 18", 24" reforzadas



 Medidas: 200, 300, 450, 600mm	 Medidas: 200, 300, 450, 600mm	
REF		
5405	2kg	10x

-  Ferro desmonta
 Desmontador de neumáticos



REF	↔	📏	📦
3380	380mm	500gr	20x
3400	400mm	480gr	50x
3500	500mm	610gr	20x
3600	600mm	1,1kg	20x

-  Apalpa folgas 14 lâminas
 Juego de galgas espesores 14 hojas



0.05, 0.06, 0.07, 0.08, 0.09, 0.10, 0.15, 0.20, 0.25, 0.30, 0.35, 0.40, 0.75, 1.00

REF	📏	📦
8123	45gr	192x

-  Apalpa folgas 32 lâminas
 Juego de galgas espesores 32 hojas



0.04, 0.05, 0.06, 0.08, 0.10, 0.13, 0.15, 0.18, 0.20, 0.23, 0.25, 0.28, 0.30, 0.33, 0.35, 0.38, 0.40, 0.43, 0.45, 0.48, 0.50, 0.55, 0.58, 0.60, 0.63, 0.65, 0.70, 0.75, 0.80, 0.88

REF	📏	📦
8124	117gr	100x

-  Alavanca deteta folgas
 Probador de holguras



-  **Aplicações:** Rolamento amortecedor, rolamento borracha, suspensão articulada, cabeça barra direção, barra acoplamento, rolamento da roda, braço axial, caixa direção e estabilizador

Para localizar fontes de falha comuns ao redor do eixo da roda Adequado para testes sob condições de carga em carros de até 3.5T

-  **Aplicaciones:** Cojinete de amortiguación, cojinete de goma, suspensión articulada, cabezal de barra de dirección, barra de acoplamiento, cojinete de rueda, brazo axial, caja de dirección y estabilizador

Para localizar fuentes de fallas alrededor del eje de la rueda Adequado para pruebas en condiciones de carga en coches hasta 3.5T

REF	📏	📦
8125	2kg	10x

- Escova de arame de aço 4 filas com cabo madeira
- Cepillo alambre acero 4 filas con mango madera



REF	↔	📏	📦
2226	200mm	108gr	120x

- Kit extractor perfis danificados TORX/HEX 19 peças
- Kit extractor perfiles dañados TORX/HEX 19 piezas



7x		1/4" x 50mm: HE1.5, HE2, HE2,5, HE3, HE4, HE5, HE6
2x		10mm x 38mm: HE8, HE10
7x		1/4" x 50mm: TE10, TE15, TE20, TE25, TE27, TE30, TE40
2x		10mm x 38mm: TE50, TE55
1x		1/2" x H10

REF	📏	📦
3074	590gr	20x

- Extractor de pernos M3-M25 6 peças
- Extractor de tornillos M3-M25 6 piezas



<p>Medidas:</p> <ul style="list-style-type: none"> N.º1 M3-M6 N.º2 M6-M8 N.º3 M8-M11 N.º4 M11-M14 N.º5 M14-M18 N.º6 M18-M25 	<p>Medidas:</p> <ul style="list-style-type: none"> N.º1 M3-M6 N.º2 M6-M8 N.º3 M8-M11 N.º4 M11-M14 N.º5 M14-M18 N.º6 M18-M25
--	--

REF	📏	📦
1295	215gr	72x

- Kit limitador profundidade brocas 7 peças
- Kit limitador de profundidad de taladro 7 piezas



6x		3, 4, 5, 6, 8, 10mm
1x		

REF	📏	📦
4451	45g	72x

- Kit para verificar medida de rosca mm e polegadas
- Kit para verificar medida de rosca mm y pulgadas



<p>Medidas:</p> <ul style="list-style-type: none"> (Prateado) M14x2.00 (Rosa) M12x1.75 (Roxo) M12x1.25 (Verde) 7/16"-20 (Preto) M14x1.50 (Dourado) M12x1.5 (Vermelho) 9/16"-18 	<p>Medidas:</p> <ul style="list-style-type: none"> (Plateado) M14x2.00 (Rosa) M12x1.75 (Morado) M12x1.25 (Verde) 7/16"-20 (Negro) M14x1.50 (Dorado) M12x1.5 (Rojo) 9/16"-18
--	---

REF	📏	📦
3051	120gr	100x

 Lima de roscas polegadas

 Lima de roscas pulgadas

Medidas lima 1: 9-10, 12-16, 20-27, 28-32

Medidas lima 2: 11-12, 13-14, 16-18, 20-24

REF



1033

373gr

30x

 Lima de roscas mm

 Lima de roscas mm

Medidas: 9, 10, 12, 16, 20, 27, 28, 32mm

REF



1032

186gr

50x

 Jogo 9 peças vazadores 3-12mm

 Juego 9 piezas sacabocados 3-12mm

Medidas: 3, 4, 5, 6, 7, 8, 10, 11, 12mm

REF



8566

733gr

15x

 Folha serra HSS 24" x 12" 10 peças

 Hoja sierra HSS 24" x 12" 10 piezas

REF



3740

197gr

100x

 Martelo ferro

 Martillo hierro

REF



1111

708gr

24x

 Martelo nylon
 Martillo nylon



Nylon preto / negro



REF 1110NP

Nylon amarelo / amarillo



REF 1110NA

REF			
1110	40mm	590gr	20x

 Martelo mecânico
 Martillo mecánico

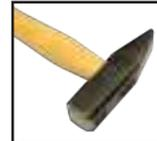

Punho para martelo mecânico
Mango para martillo mecánico



REF 11300P 300gr
REF 11500P 500gr
REF 11800P 800gr

REF			
11300	300gr	462gr	6x
11500	500gr	680gr	6x
11800	800gr	1kg	4x

 Martelo de bola
 Martillo de bola



Punho para martelo de bola
Mango para martillo de bola



REF 13300P 300gr
REF 13500P 500gr
REF 13800P 800gr

REF			
13300	300gr	458gr	6x
13500	500gr	694gr	6x
13800	800gr	1,03kg	6x

 Régua metálica graduada
 Regla metálica graduada



REF			
1330	500x28mm	115gr	1x
1335	1000x28mm	425gr	60x

 Régua metálica flexível com ímã graduada
 Regla metálica flexible con imán graduada



REF			
1340	600mm	52gr	1x

- Paquímetro aço
Pie de rey metálico



REF 1300

REF 1305



REF	↔	⚖️	📦
1300	150mm	270gr	50x
1305	200mm	360gr	50x

- Paquímetro aço escala em milímetros 150mm
Pie de rey metálico 150mm



REF	↔	⚖️	📦
1301	150mm	270gr	50x

- Paquímetro digital 150mm
Pie de rey digital 150mm



REF	↔	⚖️	📦
1310	150mm	400gr	50x

- Paquímetro digital 200mm
Pie de rey digital 200mm



REF	↔	⚖️	📦
1315	200mm	1,5kg	10x

- Micrómetro exterior 0-25mm
Micrómetro exterior 0-25mm



- Características:**
Diâmetro de abertura: 0-25mm
Graduação: 0,01mm

- Características:**
Diámetro de apertura: 0-25mm
Graduaciones de 0,01mm

REF	⊕	⚖️	📦
1320	0-25mm	200gr	50x

- Micrómetro exterior 25-50mm
Micrómetro exterior 25-50mm



- Características:**
Diâmetro de abertura: 25-50mm
Graduação: 0,01mm

- Características:**
Diámetro de apertura: 25-50mm
Graduaciones de 0,01mm

REF	⊕	⚖️	📦
1325	25-50mm	360gr	50x

 Chaves de bocas
 Llaves fijas



REF	⊕	↔	⚖	📄
100607	6x7mm	126mm	23gr	1x
100809	8x9mm	142mm	25gr	1x
101011	10x11mm	157mm	56gr	1x
101213	12x13mm	170mm	80gr	1x
101415	14x15mm	187mm	105gr	1x
101617	16x17mm	202mm	130gr	1x
101819	18x19mm	220mm	180gr	1x
102022	20x22mm	232mm	225gr	1x
102123	21x23mm	246mm	262gr	1x
102427	24x27mm	265mm	316gr	1x
102528	25x28mm	275mm	350gr	1x
103032	30x32mm	298mm	475gr	1x

 Chave boca luneta aberta com roquete
 Llave combinadas abiertas con carraca



REF	⊕	↔	⚖	📄
120208	8mm	155mm	89gr	1x
120209	9mm	155mm	85gr	1x
120210	10mm	155mm	106gr	120x
120211	11mm	170mm	200gr	120x
120212	12mm	170mm	110gr	1x
120213	13mm	185mm	154gr	120x
120214	14mm	185mm	149gr	120x
120215	15mm	185mm	214gr	1x
120216	16mm	215mm	211gr	1x
120217	17mm	215mm	203gr	1x
120218	18mm	230mm	294gr	1x
120219	19mm	230mm	289gr	1x

 Chaves de bocas DIN 3110
 Llaves fijas DIN 3110



REF	⊕	↔	⚖	📄
200607	6x7mm	120mm	20gr	100x
200809	8x9mm	140mm	40gr	100x
201011	10x11mm	155mm	55gr	100x
201213	12x13mm	170mm	75gr	100x
201415	14x15mm	185mm	110gr	100x
201617	16x17mm	200mm	145gr	100x
201819	18x19mm	220mm	330gr	50x
202022	20x22mm	235mm	220gr	50x
202123	21x23mm	245mm	280gr	50x
202427	24x27mm	260mm	360gr	50x
202528	25x28mm	270mm	480gr	25x
203032	30x32mm	295mm	520gr	25x

 Chave boca luneta com roquete
 Llave combinada con carraca



REF	⊕	↔	⚖	📄
14008	8mm	140mm	200gr	150x
14009	9mm	150mm	300gr	150x
14010	10mm	160mm	800gr	100x
14011	11mm	165mm	500gr	150x
14012	12mm	170mm	700gr	150x
14013	13mm	180mm	126gr	150x
14014	14mm	190mm	800gr	120x
14015	15mm	200mm	900gr	120x
14016	16mm	210mm	1kg	120x
14017	17mm	225mm	1,1kg	100x
14018	18mm	235mm	1,2kg	100x
14019	19mm	245mm	1,3kg	80x
14020	20mm	245mm	1,4kg	80x
14021	21mm	290mm	1,5kg	40x
14022	22mm	290mm	1,6kg	40x
14023	23mm	290mm	1,7kg	40x

 Chaves de bocas AMERICAN TYPE
 Llaves fijas AMERICAN TYPE



REF	⊕	↔	⚖	📄
203236	32x36mm	285mm	600gr	20x
203641	36x41mm	321mm	900gr	20x
204146	41x46mm	371mm	1kg	10x
204650	46x50mm	403mm	1,4kg	10x

 Chave boca luneta roquete
 Llave combinada carraca



REF	⊕	↔	⚖	📄
17008	8mm	140mm	55gr	100x
17009	9mm	150mm	55gr	100x
17010	10mm	159mm	70gr	100x
17011	11mm	165mm	85gr	100x
17012	12mm	171mm	95gr	100x
17013	13mm	178mm	130gr	100x
17014	14mm	191mm	145gr	100x
17015	15mm	200mm	160gr	50x
17016	16mm	209mm	180gr	50x
17017	17mm	225mm	200gr	50x
17018	18mm	237mm	220gr	50x
17019	19mm	245mm	223gr	50x
17020	20mm	290mm	320gr	50x
17021	21mm	290mm	330gr	50x
17022	22mm	290mm	340gr	50x
17023	23mm	335mm	480gr	25x

 Chaves de boca luneta
 Llaves combinadas

REF	⊖	↔	⚖	📦
120006	6mm	100mm	20gr	1x
120007	7mm	110mm	22gr	1x
120008	8mm	115mm	30gr	1x
120009	9mm	125mm	35gr	1x
120010	10mm	135mm	13gr	1x
120011	11mm	145mm	53gr	1x
120012	12mm	155mm	63gr	1x
120013	13mm	165mm	30gr	1x
120014	14mm	171mm	50gr	1x
120015	15mm	185mm	100gr	1x
120016	16mm	195mm	111gr	1x
120017	17mm	210mm	60gr	1x
120018	18mm	220mm	158gr	1x
120019	19mm	230mm	166gr	1x
120020	20mm	240mm	130gr	1x
120021	21mm	245mm	140gr	1x
120022	22mm	248mm	150gr	1x
120023	23mm	260mm	275gr	1x
120024	24mm	270mm	300gr	1x
120025	25mm	282mm	300gr	1x
120026	26mm	290mm	333gr	1x
120027	27mm	300mm	383gr	1x
120028	28mm	310mm	433gr	1x
120029	29mm	330mm	425gr	1x
120030	30mm	350mm	475gr	1x
120032	32mm	380mm	575gr	1x
120034	34mm	380mm	800gr	1x
120036	36mm	370mm	850gr	1x
120038	38mm	400mm	900gr	1x
120040	40mm	400mm	950gr	1x
120041	41mm	452mm	1kg	1x
120042	42mm	497mm	1,05kg	1x
120046	46mm	497mm	1,37kg	1x
120048	48mm	540mm	1,4kg	1x
120050	50mm	540mm	2,08kg	1x

 Chaves de boca luneta DIN 3113
 Llaves combinadas DIN 3113

REF	⊖	↔	⚖	📦
220006	6mm	110mm	20gr	100x
220007	7mm	120mm	20gr	100x
220008	8mm	130mm	40gr	100x
220009	9mm	140mm	40gr	100x
220010	10mm	150mm	50gr	100x
220011	11mm	160mm	55gr	100x
220012	12mm	170mm	65gr	100x
220013	13mm	180mm	80gr	100x
220014	14mm	190mm	90gr	100x
220015	15mm	200mm	110gr	100x
220016	16mm	210mm	120gr	100x
220017	17mm	220mm	150gr	100x
220018	18mm	230mm	160gr	100x
220019	19mm	240mm	220gr	100x
220020	20mm	250mm	240gr	50x
220021	21mm	260mm	260gr	50x
220022	22mm	270mm	300gr	50x
220023	23mm	280mm	320gr	50x
220024	24mm	290mm	320gr	50x
220025	25mm	300mm	360gr	50x
220026	26mm	310mm	360gr	50x
220027	27mm	320mm	400gr	20x
220028	28mm	330mm	500gr	20x
220029	29mm	340mm	500gr	20x
220030	30mm	350mm	600gr	20x
220032	32mm	370mm	700gr	20x

 Chaves de luneta
 Llaves de estrella

 Chaves de boca luneta AMERICAN TYPE
 Llaves combinadas AMERICAN TYPE

REF	⊖	↔	⚖	📦
220033	33mm	425mm	1kg	20x
220034	34mm	425mm	1kg	20x
220035	35mm	460mm	1,2kg	20x
220036	36mm	460mm	1,2kg	20x
220038	38mm	460mm	1,1kg	20x
220041	41mm	500mm	1,4kg	10x
220042	42mm	500mm	1,4kg	10x
220046	46mm	540mm	1,85kg	10x
220048	48mm	570mm	1,95kg	10x
220050	50mm	598mm	2,2kg	10x

REF	⊖	↔	⚖	📦
110607	6x7mm	175mm	60gr	400x
110809	8x9mm	185mm	76gr	200x
111011	10x11mm	198mm	90gr	200x
111213	12x13mm	215mm	125gr	200x
111415	14x15mm	228mm	145gr	150x
111617	16x17mm	246mm	200gr	100x
111819	18x19mm	268mm	290gr	100x
112022	20x22mm	292mm	330gr	60x
112123	21x23mm	315mm	350gr	60x
112427	24x27mm	328mm	375gr	40x
112528	25x28mm	342mm	425gr	40x
113032	30x32mm	370mm	575gr	40x

 Chave boca luneta c/ roquete flexível
 Llave combinada carraca flexible



 Chaves de luneta DIN 838
 Llaves de estrella DIN 838



REF	⊖	↔	⚖	📦	REF	⊖	↔	⚖	📦
18008	8mm	140mm	60gr	100x	210607	6x7mm	165mm	40gr	100x
18009	9mm	150mm	60gr	100x	210809	8x9mm	180mm	65gr	100x
18010	10mm	161mm	75gr	100x	211011	10x11mm	195mm	85gr	100x
18011	11mm	167mm	90gr	100x	211213	12x13mm	215mm	120gr	100x
18012	12mm	173mm	100gr	100x	211415	14x15mm	230mm	150gr	100x
18013	13mm	180mm	105gr	100x	211617	16x17mm	250mm	200gr	100x
18014	14mm	191mm	160gr	100x	211819	18x19mm	265mm	260gr	100x
18015	15mm	200mm	180gr	50x	212022	20x22mm	285mm	300gr	50x
18016	16mm	210mm	200gr	50x	212123	21x23mm	305mm	360gr	50x
18017	17mm	227mm	220gr	50x	212427	24x27mm	325mm	400gr	50x
18018	18mm	238mm	224gr	50x	212528	25x28mm	340mm	480gr	25x
18019	19mm	248mm	280gr	50x	213032	30x32mm	375mm	600gr	20x

 Chaves de luneta AMERICAN TYPE
 Llaves de estrella AMERICAN TYPE



REF	⊖	↔	⚖	📦
213236	32x36mm	408mm	850gr	20x
213641	36x41mm	448mm	1,05kg	20x

 Jogo 8 chaves de boca 6-22mm
 Juego 8 llaves fijas 6-22mm



 Jogo 8 chaves de boca 6-22mm
 Juego 8 llaves fijas 6-22mm



8x		6x7, 8x9, 10x11, 12x13, 14x15, 16x17, 18x19, 20x22mm
REF	⚖	📦
100008	790gr	1x

8x		6x7, 8x9, 10x11, 12x13, 14x15, 16x17, 18x19, 20x22mm
REF	⚖	📦
300008	933gr	15x

 Jogo 12 chaves de bocas 6-32mm
 Juego 12 llaves fijas 6-32mm



12x		6x7, 8x9, 10x11, 12x13, 14x15, 16x17, 18x19, 20x22, 21x23, 24x27, 25x28, 30x32mm
-----	---	--

REF		
100012	1,8kg	1x

 Jogo 12 chaves de bocas 6-32mm
 Juego 12 llaves fijas 6-32mm



12x		6x7, 8x9, 10x11, 12x13, 14x15, 16x17, 18x19, 20x22, 21x23, 24x27, 25x28, 30x32mm
-----	--	--

REF		
200012	2,3kg	8x

 Jogo 12 chaves boca luneta 6-22mm
 Juego 12 llaves combinadas 6-22mm



12x		6, 7, 8, 9, 10, 11, 12, 13, 14, 17, 19, 22mm
-----	---	--

REF		
1200012	1,33kg	12x

 Jogo 12 chaves boca luneta 6-22mm
 Juego 12 llaves combinadas 6-22mm



12x		6, 7, 8, 9, 10, 11, 12, 13, 14, 17, 19, 22mm
-----	--	--

REF		
1300012	1kg	10x

 Jogo 25 chaves boca luneta 6-32mm
 Juego 25 llaves combinadas 6-32mm



25x		6, 7, 8, 9, 10, 11, 12, 13, 14, 15, 16, 17, 18, 19, 20, 21, 22, 23, 24, 25, 26, 27, 28, 30, 32mm
-----	---	--

REF		
1200025	5,75kg	4x

 Jogo 25 chaves boca luneta 6-32mm
 Juego 25 llaves combinadas 6-32mm



25x		6, 7, 8, 9, 10, 11, 12, 13, 14, 15, 16, 17, 18, 19, 20, 21, 22, 23, 24, 25, 26, 27, 28, 30, 32mm
-----	--	--

REF		
1300025	5kg	2x

 Jogo chaves boca luneta 8 peças 33-50mm
 Juego llaves combinadas 8 piezas 33-50mm



8x		33, 34, 35, 36, 38, 41, 46, 50mm
----	--	----------------------------------

REF		
1200008	10,25kg	2x

 Chave rodas cruzada 17x19x21x23mm
 Llave cruz para rueda 17x19x21x23mm



 **Descrição:**
Aço: EN-8D
Acabamento: Cromado mate, totalmente endurecido
Tamanho: 14mm de diâmetro e 14" de comprimento

 **Descripción:**
Acero: EN-8D
Acabado: Cromado mate, totalmente templado
Tamaño: 14mm de diámetro y 14" de longitud

REF		
3067	1,05kg	10x

 Jogo 8 chaves de luneta 6-22mm
 Juego 8 llaves de estrella 6-22mm

 Jogo chave de luneta 06-22 8pcs
 Juego llaves de estrella 6-22mm 8pzs



8x		6x7, 8x9, 10x11, 12x13, 14x15, 16x17, 18x19, 20x22mm
----	---	--

8x		6x7, 8x9, 10x11, 12x13, 14x15, 16x17, 18x19, 20x22mm
----	--	--

REF		
110008	1,18kg	1x

REF		
210008	1,2kg	10x

 Jogo 12 chaves luneta 6-32mm
 Juego 12 llaves estrella 6-32mm



12x		6x7, 8x9, 10x11, 12x13, 14x15, 16x17, 18x19, 20x22, 21x23, 24x27, 25x28, 30x32mm
REF		
110012	2,8kg	6x

 Jogo 12 chaves luneta 6-32mm
 Juego 12 llaves estrella 6-32mm



12x		6x7, 8x9, 10x11, 12x13, 14x15, 16x17, 18x19, 20x22, 21x23, 24x27, 25x28, 30x32mm
REF		
210012	3,2kg	5x

 Kit chaves boca luneta roquete mm e polegadas
 Kit llaves combinadas carraca mm y polegadas



11x		6mm, 8mm, 9mm, 10mm, 12mm, 13mm, 14mm, 15mm, 16mm, 17mm, 18mm
11x		1/4", 9/32", 5/16", 11/32", 3/8", 7/16", 1/2", 9/16", 5/8", 11/16", 3/4"
REF		
122200	4,25kg	4x

 Kit chave boca roquete 14x19mm com adaptadores 8-17mm
 Kit llave boca carraca 14x19mm con adaptadores 8-17mm



5x		8, 10, 12, 13, 17 mm
REF		
8370	290gr	50x

 Chave de boca luneta aberta roquete jogo 12pcs
 Juego 12 llaves combinadas abiertas con carraca



11x		8, 9, 10, 11, 12, 13, 14, 15, 16, 17, 18, 19mm
-----	--	--

REF		
120200	2,1kg	10x

 Kit 12 peças chaves pé de galo articuladas 8-19mm 3/8"
 Kit 12 piezas llaves pies de gallo articuladas 8-19mm 3/8"



Cabeça flexível dobra até 200°
La cabeza flexible se dobla hasta 200°



12x		8, 9, 10, 11, 12, 13, 14, 15, 16, 17, 18, 19mm
-----	---	--

REF		
3830	1,7kg	10x

 Kit chaves pé de galo 3/8" 10 peças
 Kit llaves pies de gallo 3/8" 10 piezas

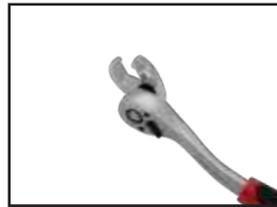

10x		10, 11, 13, 14, 15, 16, 17, 18, 19, 22mm
-----	---	--

REF		
3835	583gr	12x

 Jogo 11 chaves cachimbo 8-19mm 
 Juego 11 llaves pipa 8-19mm

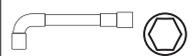

11x		8, 10, 11, 12, 13, 14, 15, 16, 17, 18, 19mm
-----	--	---

REF		
110200	2,2kg	10x

 Jogo 4 chaves curvas torx 
 Juego 4 llaves curvas torx



4x		E6xE8, E10xE12, E14xE18, E20xE24
----	--	----------------------------------

REF		
1185	530gr	36x

 Jogo chave de luneta extra longas 5 peças 
 Juego llaves estrella extra largas 5 piezas



5x			8x10 232mm, 11x13 330mm, 14x15 372mm, 16x17 410mm, 18x19mm 410mm
----	---	---	--

REF

110005L



1,33kg



12x

 Jogo chaves torx extra longas E6-E24 6 peças 
 Juego llaves torx extra largas E6-E24 6 piezas



6x			E6xE7 232mm, E8xE10 232mm, E11xE12 330mm, E14xE16 372mm, E18xE20 410mm, E22xE24 430mm
----	---	---	---

REF

150006L



1,5kg



12x

 Chave inglesa ajustável
 Llave inglesa ajustable



REF



10106	152mm	19mm	150gr	120x
10108	203mm	24mm	266gr	60x
10110	254mm	30mm	437gr	48x
10112	305mm	36mm	666gr	24x
10115	381mm	43mm	1,25kg	12x
10118	457mm	52mm	2kg	12x
10124	610mm	62mm	3,6kg	6x

 Chave em T com cardan 
 Llave en T con cardan

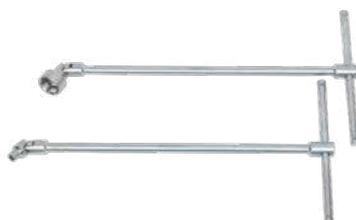

REF



2306	6mm	400mm	520gr	20x
2308	8mm	400mm	387gr	20x
2310	10mm	400mm	520gr	20x
2311	11mm	400mm	525gr	20x
2312	12mm	400mm	387gr	20x
2313	13mm	400mm	387gr	20x
2314	14mm	400mm	530gr	20x
2315	15mm	400mm	530gr	20x
2317	17mm	400mm	530gr	20x
2319	19mm	400mm	530gr	20x
2320	20mm	400mm	545gr	20x
2321	21mm	400mm	550gr	20x
2322	22mm	400mm	555gr	20x
2323	23mm	400mm	560gr	20x
2324	24mm	400mm	560gr	20x

Chave phillips
Destornillador phillips



REF	⊕	ℓ	⚖	📦
234201	PH0	100mm	40gr	360x
234202	PH1	125mm	74gr	240x
234203	PH2	150mm	108gr	144x
234204	PH2	200mm	117gr	144x
234205	PH3	200mm	172gr	96x

Chave phillips
Destornillador phillips



REF	⊕	ℓ	⚖	📦
235201	PH0	100mm	40gr	360x
235202	PH1	125mm	74gr	240x
235203	PH2	150mm	108gr	144x
235204	PH2	200mm	117gr	144x
235205	PH3	200mm	172gr	96x

Chave phillips com batente
Destornillador phillips de golpe



REF	⊕	ℓ	⚖	📦
234601	PH1	100mm	103gr	240x
234602	PH2	125mm	157gr	144x
234603	PH2	150mm	162gr	144x
234604	PH3	200mm	258gr	96x

Chave phillips com batente
Destornillador phillips de golpe



REF	⊕	ℓ	⚖	📦
235601	PH1	100mm	103gr	240x
235602	PH2	125mm	157gr	144x
235603	PH2	150mm	162gr	144x
235604	PH3	200mm	258gr	96x

Chave fenda
Destornillador plano



REF	⊖	ℓ	⚖	📦
234101	0.5x3.0	75mm	38gr	360x
234102	0.5x3.0	100mm	40gr	360x
234103	0.8x4.0	100mm	45gr	360x
234104	1.0x5.5	125mm	74gr	240x
234105	1.0x5.5	150mm	77gr	240x
234106	1.2x6.5	125mm	101gr	144x
234107	1.2x6.5	150mm	108gr	144x
234108	1.2x6.5	200mm	117gr	144x
234109	1.6x8.0	200mm	172gr	96x

Chave fenda
Destornillador plano



REF	⊖	ℓ	⚖	📦
235101	0.5x3.0	75mm	38gr	360x
235102	0.5x3.0	100mm	40gr	360x
235103	0.8x4.0	100mm	45gr	360x
235104	1.0x5.5	125mm	74gr	240x
235105	1.0x5.5	150mm	77gr	240x
235106	1.2x6.5	125mm	101gr	144x
235107	1.2x6.5	150mm	108gr	144x
235108	1.2x6.5	200mm	117gr	144x
235109	1.6x8.0	200mm	172gr	96x

Chave fenda com batente
Destornillador plano de golpe



REF	⊖	ℓ	⚖	📦
234501	1.0x5.5	100mm	103gr	240x
234502	1.2x6.5	125mm	157gr	144x
234503	1.2x6.5	150mm	162gr	144x
234504	1.6x8.0	200mm	258gr	96x
234505	1.6x8.0	250mm	278gr	96x

Chave fenda com batente
Destornillador plano de golpe



REF	⊖	ℓ	⚖	📦
235501	1.0x5.5	100mm	103gr	240x
235502	1.2x6.5	125mm	157gr	144x
235503	1.2x6.5	150mm	162gr	144x
235504	1.6x8.0	200mm	258gr	96x
235505	1.6x8.0	250mm	278gr	96x

Chave torx
 Destornillador torx



REF	⊖	ℓ	📦	📄
234301	T7	75mm	38gr	360x
234302	T8	75mm	38gr	360x
234303	T9	75mm	38gr	360x
234304	T10	100mm	70gr	240x
234305	T15	100mm	70gr	240x
234306	T20	100mm	70gr	240x
234307	T25	100mm	94gr	144x
234308	T27	100mm	94gr	144x
234309	T30	100mm	94gr	144x
234310	T40	125mm	138gr	96x

Chave torx
 Destornillador torx



REF	⊖	ℓ	📦	📄
235301	T7	75mm	44gr	360x
235302	T8	75mm	38gr	360x
235303	T9	75mm	38gr	360x
235304	T10	100mm	70gr	240x
235305	T15	100mm	70gr	240x
235306	T20	100mm	70gr	240x
235307	T25	100mm	94gr	144x
235308	T27	100mm	94gr	144x
235309	T30	100mm	94gr	144x
235310	T40	125mm	138gr	96x

Chave pozidriv
 Destornillador pozidriv



REF	⊕	ℓ	📦	📄
234401	PZ0	75mm	38gr	360x
234402	PZ1	100mm	70gr	240x
234403	PZ2	100mm	94gr	144x
234404	PZ3	150mm	151gr	96x

Chave pozidriv
 Destornillador pozidriv



REF	⊕	ℓ	📦	📄
235401	PZ0	75mm	42gr	360x
235402	PZ1	100mm	70gr	240x
235403	PZ2	100mm	94gr	144x
235404	PZ3	150mm	151gr	96x

Kit chave fenda e cruz 8 peças
 Kit destornilladores plano y phillips 8 piezas



Kit chaves torx T10-T40 7 peças
 Kit destornilladores torx T10-T40 7 piezas

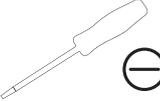
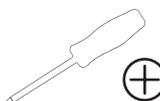

5x		CRV: 3x75mm, 4x100mm, 5.5x125mm, 6.5x125mm, 6.5x150mm
3x		CRV: PH0X100mm, PH1X125mm, PH2X150mm

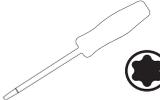
7x		T10x100mm, T15x100mm, T20x100mm, T25x100mm, T27x100mm, T30x100mm, T40x125mm
----	--	---

REF	📦	📄
3803	700gr	20x

REF	📦	📄
3804	700gr	20x

Chave em T torx
Llave en T torx



REF	⊖	ℓ	⚖	📦
120510	T10	100mm	15gr	144x
120515	T15	100mm	52gr	144x
120520	T20	100mm	55gr	144x
120525	T25	150mm	55gr	96x
120527	T27	150mm	60gr	96x
120530	T30	150mm	70gr	96x

Chave em T umbrako
Llave en T umbrako



REF	⊖	ℓ	⚖	📦
120402	2mm	100mm	43,4gr	144x
1204025	2.5mm	100mm	45,8gr	144x
120403	3mm	100mm	49,6gr	144x
120404	4mm	150mm	73,4gr	96x
120405	5mm	150mm	87,5gr	96x
120406	6mm	150mm	104gr	96x

Kit 8 chaves hexagonais com cabo em T 2-10mm
Kit 8 llaves hexagonales con cable en T 2-10mm



8x		⊖	2mm, 2,5mm, 3mm, 4mm, 5mm, 6mm, 8mm, 10mm
----	--	---	---



Descrição:
Conjunto de chaves com 3 extremidades de utilização
Cada chave é fabricada em chrome vanadium, um aço resistente para uma maior durabilidade e precisão quando usada em parafusos de cabeça hexagonal

Descripción:
Juego de llaves con 3 puntas de uso
Cada llave está hecha de chrome vanadium, un acero resistente para mayor durabilidad y precisión cuando se usa con tornillos de cabeza hexagonal

REF	⚖	📦
234700	1,25gr	8x

 Kit 9 chaves allen macho torx cabo em T deslizante T10-T50
 Kit 9 llaves en T con tres extremidades macho torx T10-T50

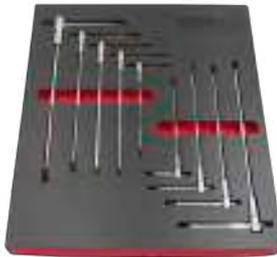

8x		T10, T15, T20, T25, T27, T30, T40, T45, T50
----	---	---



 **Descrição:**
 Conjunto de chaves em T deslizantes e com três extremidades de utilização
 Podem ser colocadas em L para um aperto com maior força ou em T caso pretenda um aperto mais rápido
 Cada chave é fabricada em chrome vanadium, um aço resistente para uma maior durabilidade

 **Descripción:**
 Juego de llaves en T deslizantes con tres extremidades de utilización
 Pueden colocarse en L para un agarre más fuerte o en T si se requiere un agarre más rápido
 Cada llave está hecha de cromo vanadio, un acero resistente para mayor durabilidad

REF		
234800	1,25gr	8x

 Chave allen macho hex com cabo T deslizante
 Llave en T con tres extremidades macho hex



REF				
234702	2mm	125mm	45gr	200x
2347025	2,5mm	150mm	45gr	200x
234703	3mm	150mm	45gr	200x
2347035	3,5mm	175mm	45gr	200x
234704	4mm	175mm	61gr	200x
2347045	4,5mm	195mm	75gr	200x
234705	5mm	195mm	92gr	200x
234706	6mm	215mm	150gr	100x
234707	7mm	230mm	155gr	100x
234708	8mm	250mm	270gr	50x
234710	10mm	280mm	425gr	40x
234712	12mm	305mm	600gr	20x
234714	14mm	330mm	800gr	20x

Chave allen macho torx com cabo T deslizante 
Llave en T con tres extremidades macho torx



REF				
234810	T10	125mm	40gr	200x
234815	T15	153mm	42gr	200x
234820	T20	196mm	67gr	200x
234825	T25	195mm	70gr	200x
234827	T27	215mm	105gr	200x
234830	T30	215mm	120gr	50x
234840	T40	230mm	250gr	20x
234845	T45	255mm	300gr	20x
234850	T50	269mm	300gr	20x

Jogo 9 chaves umbrako longas esféricas 
Juego 9 llaves umbrako largas esféricas

Jogo 9 chaves torx longas 
Juego 9 llaves torx largas



9x			1.5, 2, 2.5, 3, 4, 5, 6, 8, 10mm
----	---	---	----------------------------------

9x			T10, T15, T20, T25, T27, T30, T40, T45, T50
----	--	---	---

REF		
5516	466gr	60x

REF		
5517	437gr	60x

-  Caixa de ferramentas com 5 compartimentos
 Caja de herramientas con 5 compartimientos



 Medidas: 535x210x220mm

 Medidas: 535x210x220mm

REF

7836



4,5kg



1x

-  Jogo chaves caixa isoladas VDE 1/2" 20 peças
 Juego llaves vaso aisladas VDE 1/2" 20 piezas



13x		10mm, 11mm, 12mm, 13mm, 14mm, 16mm, 17mm, 18mm, 19mm, 21mm, 22mm, 24mm, 27mm
4x		H4*80mm, H5*80mm, H6*80mm, H8*80mm
1x		1/2": 250mm
1x		1/2": 200mm
1x		1/2": 250mm

Norma: DIN EN 60900 (VDE 0682-201):2019-04.

REF

3020



4,5kg



5x

 Jogo chaves boca e inglesa isoladas VDE 20 peças
 Juego llaves fijas e inglesa aisladas VDE 20 piezas



19x		6mm, 7mm, 8mm, 9mm, 10mm, 11mm, 12mm, 13mm, 14mm, 15mm, 16mm, 17mm, 18mm, 19mm, 21mm, 24mm, 27mm, 30mm, 32mm
1x		10"

Norma: DIN EN 60900 (VDE 0682-201):2019-04.

REF		
3021	5,1kg	4x

 Jogo chaves isoladas intercambiáveis 13pcs
 Juego destornilladores aislados intercambiables 13pzs



1x		
4x	 	0.5x3.0x75, 0.8x4.0x100, 1.0x5.5x100, 1.2x6.5x100
2x	 	PH1x100, PH2x100
2x	 	PZ1x100, PZ2x100
3x	 	T10x75, T15x100, T20x100
1x		200-250V

REF		
3805	766gr	12x

 Mala ferramenta isolada VDE 111 peças
 Malétin herramienta aislada VDE 111 piezas



Norma: DIN EN 60900 (VDE 0682-201):2013-04.

 **Composição:**
 (20x) Chaves de boca VDE: 6, 7, 8, 9, 10, 11, 12, 13, 14, 15, 16, 17, 18, 19, 21, 22, 24, 27, 30, 32mm
 (5x) Chaves de punho VDE: SL3*0.5*100mm, SL5.5*1*125mm, SL6.5*1.2*150mm, PH1*80mm, PH2*100mm
 (2x) Chaves ajustáveis VDE: 200mm, 250mm
 (8x) Alicates VDE: combinado 8", ponta longa 8", ponta curva 8", diagonal 6", ponta longa 6", descarnador de fios 6", corta cabos 10", bomba de água 10"
 (4x) Facas: 52*190mm, 38*180mm, 60*200mm, 45*180mm
 (1x) Serra: 150mm
 (4x) Pinças: ponta afiada, 135mm, ponta redondo, 160mm, ponta curva, 155mm, ponta larga, 145mm
 (1x) Grampo: 150mm
 (1x) Alicate plano: 180mm
 (3x) Tampas de plástico encaixe: 1#, 2#, 3#
 (3x) Tampas de plástico ajustáveis: 10mm, 20mm, 30mm
 (7x) Jogo de chaves de fendas de precisão: 1.5*0.23*50mm, 1.8*0.3*50mm, 2.0*0.4*50mm, 2.5*0.4*50mm, 3.0*0.5*50mm, PH00*50mm, PH0*50mm
 (50x) Jogo chaves de punho intercambiáveis isoladas: 3*70 125-250V
 (1x) Gambiarra: 28*100*5mm
 (1x) Mala trolley

 **Composición:**
 (20x) Llaves de boca VDE: 6, 7, 8, 9, 10, 11, 12, 13, 14, 15, 16, 17, 18, 19, 21, 22, 24, 27, 30, 32mm
 (5x) Destornilladores VDE: SL3*0.5*100mm, SL5.5*1*125mm, SL6.5*1.2*150mm, PH1*80mm, PH2*100mm
 (2x) Llaves ajustables VDE: 200mm, 250mm
 (8x) Alicates VDE: combinado 8", punta larga 8", punta curva 8", diagonal 6", punta larga 6", pelacables 6", cortacables 10", bomba de agua 10"
 (4x) Cuchillos: 52*190mm, 38*180mm, 60*200mm, 45*180mm
 (1x) Sierra: 150mm
 (4x) Pinzas: punta afilada 135mm, punta redonda 160mm, punta curva 155mm, punta larga 145mm
 (1x) Clip: 150mm
 (1x) Alicate plano: 180mm
 (3x) Tapas de plástico encaje: 1#, 2#, 3#
 (3x) Tapas de plástico ajustables: 10mm, 20mm, 30mm
 (7x) Juego de destornilladores precisión: 1.5*0.23*50mm, 1.8*0.3*50mm, 2.0*0.4*50mm, 2.5*0.4*50mm, 3.0*0.5*50mm, PH00*50mm, PH0*50mm
 (50x) Juego destornilladores aislados intercambiables: 3*70, 125-250V
 (1x) Lámpara: 28*100*5mm
 (1x) Maleta trolley

REF
3022

15kg

1x

ALICATES
ALICATES

02



KROFtools[®]
PROFESSIONAL TOOLS

 FAMÍLIA	PÁGINAS
01 FERRAMENTA MANUAL	11-106
02 ALICATES	109-120
03 BITS E CONJUNTOS	123-134
04 FERRAMENTA ESPECÍFICA	137-214
05 FERRAMENTA CARROÇARIA	217-222
06 REGULAÇÃO E TESTE	225-246
07 FERRAMENTA MOTOR	249-276
08 KITS SINCRONIZAÇÃO	279-350
09 FERRAMENTA ELÉTRICA	353-362
10 FERRAMENTA PNEUMÁTICA	365-378
11 FERRAMENTA HIDRÁULICA	381-404
12 FERRAMENTA LUBRIFICAÇÃO	407-414
13 EQUIPAMENTO GARAGEM	417-502
RT ROUPA DE TRABALHO	505-508
MR MERCHANDISING	511-514
EP EXPOSITORES	517-524
LR LOCALIZAÇÃO REFERÊNCIAS	527-538

 FAMILIA	PÁGINAS
01 HERRAMIENTA MANUAL	11-106
02 ALICATES	109-120
03 PUNTAS Y CONJUNTOS	123-134
04 HERRAMIENTA ESPECÍFICA	137-214
05 HERRAMIENTA DE CARROCERIA	217-222
06 REGULACIÓN Y PRUEBAS	225-246
07 HERRAMIENTA PARA MOTOR	249-276
08 KIT CALADO	279-350
09 HERRAMIENTA ELÉCTRICA	353-362
10 HERRAMIENTA NEUMÁTICA	365-378
11 HERRAMIENTA HIDRÁULICA	381-404
12 HERRAMIENTA LUBRICACIÓN	407-414
13 EQUIPAMENTO PARA TALLER	417-502
RT ROPA DE TRABAJO	505-508
MR MERCHANDISING	511-514
EP EXPOSITORES	517-524
LR LOCALIZACIÓN REFERENCIAS	527-538



 Alicates para abraçadeiras elásticas
 Alicates abrazaderas elásticas



Cabo subs.
Sirga reemp.



REF 2416-1

 **Aplicação:** Indicado para aceder a locais de espaço reduzido

 **Aplicación:** Diseñado para acceder a lugares con espacio limitado

REF				
2416	18-54mm	560mm	535gr	20x

 Alicates desconector com cabo flexível
 Alicates desconector con cable flexible



 **Aplicação:** Permite desmontagem rápida dos conectores de 2 botões

 **Aplicación:** Permite desmontaje rápida de los conectores de 2 botones

REF				
2419	3-32mm	650mm	625gr	20x

 Alicates para abraçadeiras elásticas reforçado
 Alicates abrazaderas reforzado



 **Aplicação:** Indicado para aceder a locais de espaço reduzido

 **Aplicación:** Diseñado para acceder a lugares con espacio limitado

REF				
2415	18-54mm	550mm	790gr	20x

 Alicates para abraçadeiras cabo rígido
 Alicates para abrazaderas cable rígido



 **Aplicação:** Indicado para aceder a locais de espaço reduzido

 **Aplicación:** Diseñado para acceder a lugares con espacio limitado

REF				
2418	18-54mm	550mm	708gr	24x

 Alicates de abraçadeiras clic
 Alicates de abrazaderas clic



 **Aplicação:** Para abraçadeiras clic e clic-r

 **Aplicación:** Para abrazaderas clic y clic-r

REF			
7962	170mm	240gr	50x

 Alicates de abraçadeiras multidireccional
 Alicates de abrazaderas multidireccional



 **Aplicação:** Com mandíbulas grandes (16mm) proporciona que seja mais fácil remover os grampos das abraçadeiras. Mandíbulas com forma de cruz faz com que aumente capacidade de segurar objetos, adequado para trabalhar em espaços limitados

 **Aplicación:** Con mordazas grandes (16mm) es más fácil quitar las abrazaderas. Las mandíbulas en forma de cruz aumentan la capacidad de sostener objetos, apto para trabajar en espacios limitados

REF		
7963	320gr	50x

-  Alicates abraçadeiras 8 multidireções
 Alicates abrazaderas 8 multidirecciones



REF		
7964	320gr	50x

-  Alicates de abraçadeiras OETIKER
 Alicates de abrazaderas OETIKER



-  **Aplicação:** Para instalar as juntas CV
 Usado em filtros, sistemas de refrigeração e tubos de vácuo
-  **Aplicación:** Para instalar juntas CV
 Adecuado para su uso en filtros, sistemas de refrigeración y tubos de vacío

REF			
5086	240mm	555gr	36x

-  Alicates abraçadeiras de tubo
 Alicates de abrazaderas de tubo



-  **Aplicação:** Para fácil instalação e remoção das abraçadeiras
 Punho ergonómico para maior conforto na sua utilização
-  **Aplicación:** Para una fácil instalación y extracción de abrazaderas
 Mango ergonómico para mayor comodidad de uso

REF				
6180	12-55mm	215mm	260gr	50x

-  Jogo 3 alicates desconectar tubos de combustível
 Juego 3 alicates desconexión tubos 3pzs



	Citroën, Fiat, Ford, General Motors, Peugeot, Renault
	Aplicação/Aplicación especial
	5/16" Ø 8mm
	3/8" Ø 10mm

REF			
6258	120mm	325gr	48x

-  Alicates para molas de travão
 Tenaza para muelles de freno



-  **Aplicação:** Pode ser utilizado na maioria dos travões de tambor de carros ligeiros e comerciais. Abertura máxima da mandíbula 130mm
-  **Aplicación:** Para extraer los muelles de freno del tambor de automóviles ligeros y comerciales. Apertura máxima de la mandíbula 130mm

REF			
0220	220mm	290gr	50x

-  Alicates para molas
 Tenaza para muelles



-  **Comprimento:** 300mm
-  **Longitud:** 300mm

REF			
6510	300mm	520gr	25x

 Kit 3 alicates angulares para tubos
 Juego 3 alicates angulares para tubos



 **Características:**
Tamanhos: 155mm, 165mm, 220mm
Capacidade de aperto: 10-35mm

 **Características:**
Tamaños: 155mm, 165mm, 220mm
Capacidad de sujeción: 10-35mm

REF		
6256	350gr	20x

 Kit 3 alicates para tubos
 Juego 3 alicates para tubos



 **Características:**
Tamanhos: 155mm, 185mm, 255mm
Capacidade de aperto: 3-40mm

 **Características:**
Medidas: 155mm, 185mm, 255mm
Capacidad de sujeción: 3-40mm

REF		
6257	325gr	40x

 Alicates tubo combustível VAG
 Alicates tubo combustible VAG



 **Aplicação:** Alicates para abraçadeiras 3 terminais VAG
Mandíbulas móveis ideais para áreas estreitas
Para uso em grampos de mangueira 'estilo tag'
Aperto assistido por mola **Medidas:** Abertura: 24mm

 **Aplicación:** Alicates para pinzas 3 terminales VAG
Mandíbulas móviles ideales para áreas estrechas
Para uso en abrazaderas de manguera 'estilo tag'
Apriete asistido por resorte **Medidas:** Apertura: 24mm

REF			
6250	190mm	187gr	48x

 Alicates para desconectar tubos filtro de combustível
 Alicates para desconectar conectores de combustible



 **Aplicação:** Retira sem danificar os tubos de combustível

 **Aplicación:** Retira sin dañar los tubos de combustible

REF			
6259	180mm	251gr	1x

 Alicates abraçadeira para foles transmissão 3/8" DR
 Alicates abrazadera para fuelle palier 3/8" DR



 **Aplicação:** Para apertar as abraçadeiras de aço inoxidável em combinação com um roquete 3/8"

 **Aplicación:** Para apretar las abrazaderas de acero fino en combinación con una carraca 3/8"

REF			
6187	3/8"	925gr	20x

 Alicates abraçadeiras transmissões homocinéticas
 Alicates abrazaderas juntas homocineticas



 **Aplicação:** Funciona com um roquete 1/2" uma chave ou uma alavanca para criar tensão na abraçadeira

 **Aplicación:** Funciona con una carraca 1/2" una llave o una palanca para crear tensión en la abrazadera

REF			
6186	1/2"	277gr	36x

 Alicates para abraçadeiras de tubo de escape
 Alicates para abrazaderas escape



PSA, Renault

REF



20-60mm



300mm



444gr



36x

 Alicates remoção apoios borracha tubo escape
 Tenaza para retirar soportes de caucho tubos escape

 VW, Audi, Mercedes, Saab, Mitsubishi Nissan,
 Honda, Ford, Land Rover, Mazda, Toyota,
 Opel

REF



406gr



32x

 Alicates p/ abraçadeiras 260mm
 Alicates abrazadera 260mm

 Alfa Romeo, Citroën, Fiat, Ford, Hyundai,
 Lancia, Mercedes, Opel, Peugeot Porsche,
 Renault, Seat, Škoda, Toyota, Volvo, etc.

 **Aplicação:** Especialmente concebido para braçadeiras de mangueira que ocupam pouco espaço
 Mecanismo de torniquete para manter as pinças abertas
 Adequado para o novo tipo de braçadeiras de mangueira nas tubagens de combustível VAG

 **Aplicación:** Especialmente diseñado para abrazaderas de manguera que ahorran espacio
 Mecanismo de torniquete para mantener las abrazaderas abiertas
 Especialmente adecuado para el nuevo tipo de abrazaderas de manguera en las líneas de combustible VAG

REF



400gr



20x

 Rebitador porcas e rebites
 Kit remachadora tuercas y remaches



 **Aplicação:**
 Rebites: 3,2, 4,0, 4,8 e 6,4mm
 Rebites porca: M4, M5, M6, M8, M10, M12
 Rebites parafuso: M4, M5, M6, M8

 **Aplicación:**
 Remaches: 3,2, 4,0, 4,8 y 6,4mm
 Remaches tuerca: M4, M5, M6, M8, M10, M12
 Remaches tornillo: M4, M5, M6, M8

REF



3,66kg



6x

Rebitadora de porcas M3-M12
Remachadora de tuercas M3-M12



Características:
Curso máximo de trabalho: 9mm
Adaptadores de rebites: M3, M4, M5, M6, M8, M10, M12

Características:
Curso máximo de trabalho: 9mm
Adaptadores de remaches: M3, M4, M5, M6, M8, M10, M12

REF		
3739	3,14kg	5x

Alicate segmentos
Alicate anillos pistón

Rebitador profesional
Remachadora profesional



REF 7966



REF 7967



REF 7968



Aplicação: Esta ferramenta destina-se a ser usada para instalar os seguintes tamanhos de rebites e tipo de materiais:
Alumínio: 2.4mm (3/32) - 3.2mm (1/8) - 4.0mm (5/32) - 4.8mm (3/16)
Aço: 2.4mm (3/32) - 3.2mm (1/8) - 4.0mm (5/32)
Aço inoxidável: 2.4mm (3/32) - 3.2mm (1/8) - 4.0mm (5/32)
Datos técnicos: Comprimento: 200mm, Curso máximo: 7mm
Curso efetivo de trabalho: 5-6mm

Aplicación: Esta herramienta está destinada a la instalación de los siguientes tamaños de remaches y tipos de materiales:
Aluminio: 2,4mm (3/32) - 3,2mm (1/8) - 4,0mm (5/32) - 4,8mm (3/16)
Acero: 2,4mm (3/32) - 3,2mm (1/8) - 4,0mm (5/32)
Acero inoxidable: 2,4mm (3/32) - 3,2mm (1/8) - 4,0mm (5/32)
Datos técnicos: Longitud: 200mm, Carrera máxima: 7mm
Carrera efectiva: 5-6mm

REF			
7966	4" 40-100mm	325gr	40x
7967	6" 80-120mm	325gr	40x
7968	8" 110-160mm	450gr	40x

REF			
3735	200mm	500gr	20x

-  Alicates bomba de água ajuste rápido
 Tenaza para bomba de agua ajuste rapido



 **Descrição:** Ajuste 24 posições. Revestimento pega PVC

 **Descripción:** Ajuste 24 posiciones. Revestimiento mango PVC

REF	⌀	K-H	📦	📄
13007	42mm	180mm	150gr	100x

-  Alicates bomba de água ajuste rápido 7"
 Tenaza para bomba de agua ajuste rápido 7"



 **Descrição:** Forjado com CrV

 **Descripción:** Forjado con CrV

REF	⌀	K-H	📦	📄
15007	25mm	183mm	203gr	120x

-  Alicates bomba de água ajuste automático 7"
 Tenaza para bomba de agua ajuste automático 7"



 **Descrição:** Forjado com CrV

 **Descripción:** Forjado con CrV

REF	⌀	K-H	📦	📄
16007	25mm	174mm	160gr	120x

-  Alicates bomba de água ajuste rápido 10"
 Tenaza para bomba de agua ajuste rápido 10"



 **Descrição:** Ajuste 7 posições. Revestimento pega PVC

 **Descripción:** Ajuste 7 posiciones. Revestimiento mango PVC

REF	⌀	K-H	📦	📄
13010	50mm	250mm	300gr	50x

-  Alicates bomba de água ajuste rápido 10"
 Tenaza para bomba de agua ajuste rápido 10"



 **Descrição:** Forjado com CrV

 **Descripción:** Forjado con CrV

REF	⌀	K-H	📦	📄
15010	30mm	240mm	321gr	60x

-  Alicates bomba de água ajuste automático 10"
 Tenaza para bomba de agua ajuste automático 10"



 **Descrição:** Forjado com CrV

 **Descripción:** Forjado con CrV

REF	⌀	K-H	📦	📄
16010	35mm	240mm	360gr	60x

 Alicata bomba de água ajuste rápido 12"
 Tenaza para bomba de agua ajuste rapido 12"



 **Descrição:** Forjado com CrV

 **Descripción:** Forjado con CrV

REF				
15012	40mm	310mm	555gr	36x

 Alicata bomba de água ajuste automático 12"
 Tenaza para bomba de agua ajuste automático 12"



 **Descrição:** Forjado com CrV

 **Descripción:** Forjado con CrV

REF				
16012	40mm	300mm	555gr	36x

 Alicata bomba de água ajuste rápido 16"
 Tenaza para bomba de agua ajuste rápido 16"



 **Descrição:** Forjado com CrV

 **Descripción:** Forjado con CrV

REF				
15016	80mm	415mm	1,05kg	24x

 Alicata cabos velas ignição
 Tenaza para cables de bujias



 **Descrição:** Remove com segurança os cabos das velas de ignição e evita que estes se danifiquem
As pegas e mandíbulas dos alicates são revestidas de borracha resistente para uma melhor aderência

 **Descripción:** Retira con seguridad los cables de las bujias y evita que se dañen
Los mangos y las mordazas de los alicates estan recubiertos de goma resistente para un mejor agarre

REF		
7969	275gr	40x

 Alicata para retenção de válvulas
 Alicata para juntas de válvulas



VW, Opel, Ford, etc

 **Aplicação:** Para fácil remoção do vedante da válvula
Comprimento: 250mm

 **Aplicación:** Para facilitar la extracción de la junta de la válvula
Longitud: 250mm

REF			
2985	250mm	375gr	40x

 Alicata soldar fios 240mm
 Alicata para solar alambre 240mm



 **Aplicação:** Concebido para segurar dois fios enquanto são soldados em conjunto

 **Aplicación:** Diseñado para mantener dos cables juntos mientras se sueldan entre sí

REF			
7965	240mm	250gr	48x

-  Alicates freios rolamentos
 Alicates frenos rodamientos



Citroën: C1; 1.0 Petrol, 1.4Hdi (05-15)
 Peugeot: 107; 1.0 gasolina, 1.4Hdi (05-15);
 Renault: Clio; Mk2 2.0 16V Sport (98-05);
 Toyota: Aygo; 1.0 Petrol, 1.4Hdi (05-15)

REF			
2414	41mm	200gr	30x

-  Alicates longo reto p/ abraçadeiras - articulado duplo
 Alicates larga recta p/ abrazaderas - doble articulación



-  **Descrição:**
 Os mordentes angulares especiais tornam-no adequado para uma variedade de anéis e braçadeiras de fita plana
 Capacidade 0 - 50 mm com um comprimento de 430mm
 A característica de junta dupla significa que é útil em áreas apertadas
 O bloqueio de posição mantém a abraçadeira aberta
 Pega apoiada com mola

-  **Descripción:**
 Las mordazas anguladas especiales la hacen adecuada para una gran variedad de abrazaderas de anillo y banda plana
 Capacidad de 0 - 50 mm con una longitud de 430 mm
 La característica de doble articulación la hace útil en espacios reducidos
 El bloqueo de posición mantiene la abrazadera abierta
 Mango con resorte

REF			
2412	430mm	650gr	20x

-  Alicates pressão auto-ajustável 6"
 Mordazas grip autoajustable automatica 6"



-  **Descrição:**
 Maxilas: Aço-Crómio-Vanádio (CrV)
 Cabo: Aço-carbono

-  **Descripción:**
 Mandíbulas: Acero Cromo-Vanadio (CrV)
 Mango: Acero al carbono

REF				
2401	20mm	173mm	260gr	60x

-  Alicates pressão auto-ajustável 10"
 Mordazas grip autoajustable automatica 10"



-  **Descrição:**
 Maxilas: Aço-Crómio-Vanádio (CrV)
 Cabo: Aço-carbono

-  **Descripción:**
 Mandíbulas: Acero Cromo-Vanadio (CrV)
 Mango: Acero al carbono

REF				
2402	25mm	244mm	633gr	24x

-  Alicates de pressão 10"
 Mordaza grip 10"



-  **Abertura:** 63mm

-  **Apertura:** 63mm

REF				
0111	63mm	250mm	527gr	24x

 Alicates pressão de pontas finas auto-ajustável 7"
 Mordazas grip autoajustable automatica 7"



 **Descrição:**
Maxilas: Aço-Crómio-Vanádio (CrV)
Cabo: Aço-carbono

 **Descripción:**
Mandíbulas: Acero Cromo-Vanadio (CrV)
Mango: Acero al carbono

REF				
2403	30mm	203mm	279gr	48x

 Alicates de pressão para fêmeas e tubos
 Mordaza grip para tuercas



 **Aplicação:** Para fêmeas 26mm

 **Aplicación:** Para tuercas 26mm

REF				
6509	35mm	210mm	300gr	1x

 Alicates pressão tipo-c auto-ajustável 7"
 Mordazas grip c-type autoajustable automatica 7"



 **Descrição:**
Maxilas e cabo: Aço-carbono

 **Descripción:**
Mandíbulas y mango: Acero al carbono

REF				
2404	45mm	226mm	358gr	36x

 Alicates pressão tipo-c auto-ajustável 10"
 Mordazas grip c-type autoajustable automatica 10"



 **Descrição:**
Maxilas e cabo: Aço-carbono

 **Descripción:**
Mandíbulas y mango: Acero al carbono

REF				
2405	105mm	288mm	900gr	24x

 Jogo de alicates de pressão 3 peças
 Juego mordazas grip 3 piezas



 **Descrição:** Alicates ponta reta, ponta curva 90°
Ponta curva 45°

 **Descripción:** Mordaza grip punta recta, punta curva 90°
Punta curva 45°

REF			
1115	380mm	1,5kg	8x

 Alicates cortar tubos escape com corrente
 Mordaza grip corta tubos con cadena



 **Características:**
Ideal para cortar tubos de plástico, cobre, alumínio e aço
Capacidade de corte: Ø85mm
Adequado para cortar tubos de parede fina com espessura até 2,5mm

 **Características:**
Ideal para cortar tubos de plástico, cobre, aluminio y acero
Capacidad de corte: Ø85mm
Adequado para cortar tubos de pared delgada con espesor hasta 2,5mm

REF			
6178	160mm	666gr	12x

 Alicates corte diagonal
 Alicates corte diagonal

138200

141150-141200



REF	↔	⚖	📦
138200	200mm	383gr	60x
141150	150mm	216gr	60x
141200	200mm	300gr	60x

 Alicates de corte
 Alicates de corte



REF	↔	⚖	📦
131150	150mm	177gr	1x
131175	175mm	304gr	1x

 Alicates universal isolado
 Alicates universal aislado



REF	⊘	↔	⚖	📦
140150	28mm	6" 150mm	250gr	60x
140175	34mm	7" 175mm	333gr	60x
140200	42mm	8" 200mm	383gr	60x

 Alicates universal
 Alicates universal



REF	↔	⚖	📦
130150	6" 150mm	239gr	1x
130175	7" 175mm	288gr	1x
130200	8" 200mm	388gr	1x

 Alicates de pontas direitas
 Alicates de puntas rectas



REF	⊘	↔	⚖	📦
143150	48mm	6" 150mm	200gr	60x
143200	64mm	8" 200mm	283gr	60x

 Alicates de pontas direitas
 Alicates de puntas rectas



REF	↔	⚖	📦
133150	150mm	197gr	1x
133175	175mm	229gr	1x
133200	200mm	333gr	1x

 Alicates de pontas curvas
 Alicates de puntas curvas



REF	↻	↔	⚖	📄
144150	48mm	6" 150mm	200gr	60x
144200	64mm	8" 200mm	283gr	60x

 Alicates de pontas curvas
 Alicates de puntas curvas



REF	↔	⚖	📄
134150	150mm	197gr	1x
134175	175mm	200gr	1x
134200	200mm	266gr	1x

 Alicates de freios fechar direito
 Alicates de puntas interior recto



REF	↔	⚖	📄
132125	125mm	125gr	1x
132175	175mm	125gr	1x

 Alicates freios abrir direito
 Alicates puntas exterior recto



REF	↔	⚖	📄
136125	125mm	125gr	1x
136175	175mm	183gr	1x

 Alicates freios fechar curvo
 Alicates puntas interior curvo



REF	↔	⚖	📄
135125	125mm	125gr	1x
135175	175mm	183gr	1x

 Alicates freios abrir curvo
 Alicates de puntas exterior curvo



REF	↔	⚖	📄
137125	125mm	125gr	1x
137175	175mm	183gr	1x

 Kit alicate freios 4 peças interior e exterior curvo e direito
 Juego alicate puntas 4 piezas interior y exterior curvo y recto

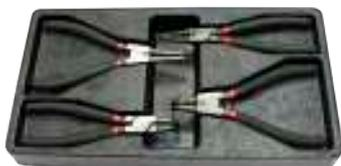

 **Composição:**
 (1x) Alicates de freios fechar direito, (1x) Alicates de freios abrir direito
 (1x) Alicates de freios fechar curvo, (1x) Alicates de freios abrir curvo

 **Composición:**
 (1x) Alicates de puntas exterior recto, (1x) Alicates de puntas exterior curvo
 (1x) Alicates de puntas interior curvo, (1x) Alicates de freios abrir curvo

REF	↔	📏	📦
132500	175mm	850gr	1x

 Jogo 4 alicates para freios 175mm 19-60mm
 Juego 4 alicate puntas 175mm 19-60mm



 **Descrição:**
 Mola encastrada: Uma flexibilidade de utilização ideal / Limita os riscos de perda e/ou ejeção da mola
 Ponteiras em corda de piano: Melhor manutenção dos freios / Reforçada para limitar os riscos de rutura

 **Descripción:**
 Muelle encastrado: Una flexibilidad óptima de utilización
 Conteras Cuerda de piano: Mejor mantenimiento de los frenos / Reforzada para limitar los riesgos de rotura

REF	↔	📏	📦
140000	175mm	1,6kg	5x

 Alicates freios interiores puntas 90°
 Alicates puntas interior 90°



REF	↔	📏	📦
140002	8-13mm	133gr	24x
140003	12-25mm	133gr	24x
140004	19-60mm	216gr	24x
140005	40-100mm	304gr	24x
140006	85-200mm	625gr	12x

 Alicates freios interiores puntas dereitas
 Alicates puntas recto interior

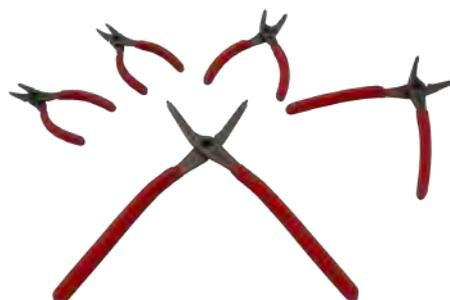

REF	↔	📏	📦
140007	8-13mm	131gr	48x
140008	12-25mm	135gr	48x
140009	19-60mm	216gr	24x
140010	40-100mm	304gr	24x
140011	85-200mm	625gr	12x

 Alicates freios exteriores puntas 90°
 Alicates puntas exterior 90°



REF	↔	📏	📦
140012	3-9mm	137gr	24x
140013	10-25mm	137gr	24x
140014	19-60mm	191gr	24x
140015	40-100mm	350gr	24x
140016	85-200mm	603gr	12x

 Alicates freios exteriores puntas dereitas
 Alicates puntas recto exterior



REF	↔	📏	📦
140017	3-9mm	135gr	48x
140018	10-25mm	135gr	48x
140019	19-60mm	191gr	24x
140020	40-100mm	350gr	24x
140021	85-200mm	603gr	12x

BITS E CONJUNTOS
PUNTAS Y CONJUNTOS

03



KROFtools[®]
PROFESSIONAL TOOLS

 FAMÍLIA	PÁGINAS
01 FERRAMENTA MANUAL	11-106
02 ALICATES	109-120
03 BITS E CONJUNTOS	123-134
04 FERRAMENTA ESPECÍFICA	137-214
05 FERRAMENTA CARROÇARIA	217-222
06 REGULAÇÃO E TESTE	225-246
07 FERRAMENTA MOTOR	249-276
08 KITS SINCRONIZAÇÃO	279-350
09 FERRAMENTA ELÉTRICA	353-362
10 FERRAMENTA PNEUMÁTICA	365-378
11 FERRAMENTA HIDRÁULICA	381-404
12 FERRAMENTA LUBRIFICAÇÃO	407-414
13 EQUIPAMENTO GARAGEM	417-502
RT ROUPA DE TRABALHO	505-508
MR MERCHANDISING	511-514
EP EXPOSITORES	517-524
LR LOCALIZAÇÃO REFERÊNCIAS	527-538

 FAMILIA	PÁGINAS
01 HERRAMIENTA MANUAL	11-106
02 ALICATES	109-120
03 PUNTAS Y CONJUNTOS	123-134
04 HERRAMIENTA ESPECÍFICA	137-214
05 HERRAMIENTA DE CARROCERIA	217-222
06 REGULACIÓN Y PRUEBAS	225-246
07 HERRAMIENTA PARA MOTOR	249-276
08 KIT CALADO	279-350
09 HERRAMIENTA ELÉCTRICA	353-362
10 HERRAMIENTA NEUMÁTICA	365-378
11 HERRAMIENTA HIDRÁULICA	381-404
12 HERRAMIENTA LUBRICACIÓN	407-414
13 EQUIPAMENTO PARA TALLER	417-502
RT ROPA DE TRABAJO	505-508
MR MERCHANDISING	511-514
EP EXPOSITORES	517-524
LR LOCALIZACIÓN REFERENCIAS	527-538



Bits 1/4" 
Puntas 1/4"



REF		∅	TIPO	FACES/ CARAS		
14121	PH1	25mm	CURTO/CORTA	Phillips	10gr	100x
14122	PH2	25mm	CURTO/CORTA	Phillips	10gr	100x
14131	PZ1	25mm	CURTO/CORTA	Pozidriv	10gr	100x
14132	PZ2	25mm	CURTO/CORTA	Pozidriv	10gr	100x
14161	0,5x3	25mm	CURTO/CORTA	Fenda/Plana	5gr	100x
14162	0,8x4	25mm	CURTO/CORTA	Fenda/Plana	5gr	100x
14163	0,8x5	25mm	CURTO/CORTA	Fenda/Plana	10gr	100x
14164	1,0x6	25mm	CURTO/CORTA	Fenda/Plana	10gr	100x
14181	3mm	25mm	CURTO/CORTA	Hex	10gr	100x
14182	4mm	25mm	CURTO/CORTA	Hex	10gr	100x
14183	5mm	25mm	CURTO/CORTA	Hex	10gr	100x
14184	6mm	25mm	CURTO/CORTA	Hex	10gr	100x

REF		∅	TIPO	FACES/ CARAS		
14185	7mm	25mm	CURTO/CORTA	Hex	10gr	100x
14186	8mm	25mm	CURTO/CORTA	Hex	10gr	100x
14187	10mm	25mm	CURTO/CORTA	Hex	10gr	100x
14191	T8	25mm	CURTO/CORTA	Torx	10gr	100x
14192	T10	25mm	CURTO/CORTA	Torx	10gr	100x
14193	T15	25mm	CURTO/CORTA	Torx	10gr	100x
14194	T20	25mm	CURTO/CORTA	Torx	10gr	100x
14190	T25	25mm	CURTO/CORTA	Torx	10gr	100x
14195	T27	25mm	CURTO/CORTA	Torx	10gr	100x
14196	T30	25mm	CURTO/CORTA	Torx	10gr	100x
14197	T40	25mm	CURTO/CORTA	Torx	10gr	100x

Bits 5/16" 
Puntas 5/16"



REF		∅	TIPO	FACES/ CARAS		
14141	PH1	30mm	CURTO/CORTA	Phillips	10gr	100x
14142	PH2	30mm	CURTO/CORTA	Phillips	10gr	100x
14143	PH3	30mm	CURTO/CORTA	Phillips	10gr	100x
14151	PZ1	30mm	CURTO/CORTA	Pozidriv	10gr	100x
14152	PZ2	30mm	CURTO/CORTA	Pozidriv	10gr	100x
14153	PZ3	30mm	CURTO/CORTA	Pozidriv	10gr	100x
14171	0,8x3	30mm	CURTO/CORTA	Fenda/Plana	11gr	100x
14172	1x5.5	30mm	CURTO/CORTA	Fenda/Plana	11gr	100x
14173	1x6	30mm	CURTO/CORTA	Fenda/Plana	12gr	100x
14174	1,2x7	30mm	CURTO/CORTA	Fenda/Plana	12gr	100x
14201	T20	30mm	CURTO/CORTA	Torx	10gr	100x
14202	T25	30mm	CURTO/CORTA	Torx	10gr	100x
14207	T27	30mm	CURTO/CORTA	Torx	11gr	100x
14208	T30	30mm	CURTO/CORTA	Torx	11gr	100x
14209	T40	30mm	CURTO/CORTA	Torx	12gr	100x

REF		∅	TIPO	FACES/ CARAS		
14210	T45	30mm	CURTO/CORTA	Torx	11gr	100x
14211	T50	30mm	CURTO/CORTA	Torx	13gr	100x
14223	T55	30mm	CURTO/CORTA	Torx	13gr	100x
14212	T60	30mm	CURTO/CORTA	Torx	13gr	100x
14213	3mm	30mm	CURTO/CORTA	Hex	10gr	100x
14214	4mm	30mm	CURTO/CORTA	Hex	11gr	100x
14215	5mm	30mm	CURTO/CORTA	Hex	13gr	100x
14217	6mm	30mm	CURTO/CORTA	Hex	13gr	100x
14218	7mm	30mm	CURTO/CORTA	Hex	12gr	100x
14219	8mm	30mm	CURTO/CORTA	Hex	14gr	100x
14220	10mm	30mm	CURTO/CORTA	Hex	18gr	100x
14221	12mm	30mm	CURTO/CORTA	Hex	21gr	100x
14222	14mm	30mm	CURTO/CORTA	Hex	26gr	100x
14305	M5	30mm	CURTO/CORTA	Hex	11gr	100x
14306	M6	30mm	CURTO/CORTA	Hex	12gr	100x

Bits 10mm 
Puntas 10mm



REF		∅	TIPO	FACES/ CARAS		
10430	4mm	30mm	CURTO/CORTA	Hex	12gr	100x
10530	5mm	30mm	CURTO/CORTA	Hex	12gr	100x
10630	6mm	30mm	CURTO/CORTA	Hex	13gr	100x

REF		∅	TIPO	FACES/ CARAS		
10730	7mm	30mm	CURTO/CORTA	Hex	14gr	100x
10830	8mm	30mm	CURTO/CORTA	Hex	15gr	100x
11030	10mm	30mm	CURTO/CORTA	Hex	18gr	100x

REF	⊕	↓	TIPO	FACES/ CARAS	⚖	📄
10475	4mm	75mm	LONGO/LARGA	Hex	40gr	300x
10575	5mm	75mm	LONGO/LARGA	Hex	40gr	300x
10675	6mm	75mm	LONGO/LARGA	Hex	41gr	300x
10775	7mm	75mm	LONGO/LARGA	Hex	42gr	300x
10875	8mm	75mm	LONGO/LARGA	Hex	41gr	300x
11075	10mm	75mm	LONGO/LARGA	Hex	49gr	300x
20530	M5	30mm	CURTO/CORTA	xzn	13gr	200x
20630	M6	30mm	CURTO/CORTA	xzn	14gr	200x
20830	M8	30mm	CURTO/CORTA	xzn	15gr	200x
21030	M10	30mm	CURTO/CORTA	xzn	17gr	200x
21230	M12	30mm	CURTO/CORTA	xzn	20gr	200x
20575	M5	75mm	LONGO/LARGA	xzn	42gr	200x
20675	M6	75mm	LONGO/LARGA	xzn	42gr	200x
20875	M8	75mm	LONGO/LARGA	xzn	43gr	200x
21075	M10	75mm	LONGO/LARGA	xzn	46gr	200x
21275	M12	75mm	LONGO/LARGA	xzn	57gr	200x

REF	⊕	↓	TIPO	FACES/ CARAS	⚖	📄
22030	T20	30mm	CURTO/CORTA	Torx	10gr	200x
22530	T25	30mm	CURTO/CORTA	Torx	10gr	200x
22730	T27	30mm	CURTO/CORTA	Torx	11gr	200x
23030	T30	30mm	CURTO/CORTA	Torx	14gr	200x
24030	T40	30mm	CURTO/CORTA	Torx	14gr	200x
25030	T50	30mm	CURTO/CORTA	Torx	19gr	200x
25530	T55	30mm	CURTO/CORTA	Torx	19gr	200x
26030	T60	30mm	CURTO/CORTA	Torx	23gr	200x
22075	T20	75mm	LONGO/LARGA	Torx	42gr	300x
22575	T25	75mm	LONGO/LARGA	Torx	41gr	300x
22775	T27	75mm	LONGO/LARGA	Torx	41gr	300x
23075	T30	75mm	LONGO/LARGA	Torx	43gr	300x
24075	T40	75mm	LONGO/LARGA	Torx	44gr	300x
24575	T45	75mm	LONGO/LARGA	Torx	75mm	300x
25075	T50	75mm	LONGO/LARGA	Torx	47gr	300x
25575	T55	75mm	LONGO/LARGA	Torx	51gr	300x
26075	T60	75mm	LONGO/LARGA	Torx	57gr	300x

Bits 10mm ● para jogo 6160
 Puntas 10mm ● para juego 6160

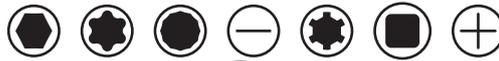

REF	⊕	↓	TIPO	FACES/ CARAS	⚖	📄
6160H04	4mm	30mm	CURTO/CORTA	Hex	12gr	200x
6160H05	5mm	30mm	CURTO/CORTA	Hex	12gr	200x
6160H06	6mm	30mm	CURTO/CORTA	Hex	13gr	200x
6160H07	7mm	30mm	CURTO/CORTA	Hex	14gr	200x
6160H08	8mm	30mm	CURTO/CORTA	Hex	15gr	200x
6160H09	9mm	30mm	CURTO/CORTA	Hex	16gr	200x
6160H10	10mm	30mm	CURTO/CORTA	Hex	18gr	200x
6160H12	12mm	30mm	CURTO/CORTA	Hex	21gr	200x
6160H14	14mm	30mm	CURTO/CORTA	Hex	22gr	200x
6160H17	17mm	30mm	CURTO/CORTA	Hex	23gr	200x
6160H04L	4mm	75mm	LONGO/LARGA	Hex	40gr	200x
6160H05L	5mm	75mm	LONGO/LARGA	Hex	41gr	200x
6160H06L	6mm	75mm	LONGO/LARGA	Hex	41gr	200x
6160H07L	7mm	75mm	LONGO/LARGA	Hex	42gr	200x
6160H08L	8mm	75mm	LONGO/LARGA	Hex	42gr	200x
6160H09L	9mm	75mm	LONGO/LARGA	Hex	48gr	200x
6160H10L	10mm	75mm	LONGO/LARGA	Hex	49gr	200x
6160H12L	12mm	75mm	LONGO/LARGA	Hex	53gr	200x
6160T20	T20	30mm	CURTO/CORTA	Torx	10gr	200x
6160T25	T25	30mm	CURTO/CORTA	Torx	10gr	200x
6160T27	T27	30mm	CURTO/CORTA	Torx	11gr	200x
6160T30	T30	30mm	CURTO/CORTA	Torx	12gr	200x
6160T40	T40	30mm	CURTO/CORTA	Torx	14gr	200x
6160T45	T45	30mm	CURTO/CORTA	Torx	14gr	200x
6160T50	T50	30mm	CURTO/CORTA	Torx	14gr	200x
6160T55	T55	30mm	CURTO/CORTA	Torx	19gr	200x

REF	⊕	↓	TIPO	FACES/ CARAS	⚖	📄
6160T60	T60	30mm	CURTO/CORTA	Torx	23gr	200x
6160T20HL	T20	75mm	LONGO/LARGA	Torx	40gr	200x
6160T25HL	T25	75mm	LONGO/LARGA	Torx	40gr	200x
6160T27HL	T27	75mm	LONGO/LARGA	Torx	40gr	200x
6160T30HL	T30	75mm	LONGO/LARGA	Torx	40gr	200x
6160T40HL	T40	75mm	LONGO/LARGA	Torx	43gr	200x
6160T45HL	T45	75mm	LONGO/LARGA	Torx	43gr	200x
6160T50HL	T50	75mm	LONGO/LARGA	Torx	44gr	200x
6160T55HL	T55	75mm	LONGO/LARGA	Torx	45gr	200x
6160T60HL	T60	75mm	LONGO/LARGA	Torx	53gr	200x
6160X05	M5	30mm	CURTO/CORTA	xzn	13gr	200x
6160X06	M6	30mm	CURTO/CORTA	xzn	13gr	200x
6160X08	M8	30mm	CURTO/CORTA	xzn	15gr	200x
6160X10	M10	30mm	CURTO/CORTA	xzn	17gr	200x
6160X12	M12	30mm	CURTO/CORTA	xzn	20gr	200x
6160XM05L	M5	75mm	LONGO/LARGA	xzn	42gr	300x
6160XM06L	M6	75mm	LONGO/LARGA	xzn	42gr	300x
6160XM08L	M8	75mm	LONGO/LARGA	xzn	43gr	300x
6160XM09L	M9	75mm	LONGO/LARGA	xzn	46gr	300x
6160XM10L	M10	75mm	LONGO/LARGA	xzn	46gr	300x
6160XM12L	M12	75mm	LONGO/LARGA	xzn	57gr	300x
6160XM14L	M14	75mm	LONGO/LARGA	xzn	57gr	300x
6160XM16HL	M16H	75mm	LONGO/LARGA	xzn	57gr	300x
6160F08	8mm	30mm	CURTO/CORTA	Fenda/Plana	12gr	200x
6160R06L	R6	75mm	LONGO/LARGA	Ribe	13gr	300x
6160R08L	R8	75mm	LONGO/LARGA	Ribe	17gr	300x

REF	⊖	ℓ	TIPO	FACES/ CARAS	⚖	📦
6160R10L	R10	75mm	LONGO/LARGA	Ribe	17gr	300x
6160R12L	R12	75mm	LONGO/LARGA	Ribe	20gr	300x
6160H38	3/8"	75mm	LONGO/LARGA	Hex	45gr	300x

 **Ponteira magnética M6**
 **Punta magnética para tornillos M6**



REF	⊖	⚖	📦
1902S6	M6	4gr	200x

 **Adaptador de 1/4" para bits 1/4"**
 **Adaptador de 1/4" para puntas 1/4"**



REF	ℓ	⚖	📦
12411	60mm	10gr	150x

 **Adaptador para bits 1/4" com engate rápido**
 **Adaptador para puntas 1/4" con encaje rápido**



REF	ℓ	⚖	📦
12412	60mm	22gr	1x

 **Adaptador 3/8" para bits 5/16"**
 **Adaptador 3/8" para puntas 5/16"**



REF	ℓ	⚖	📦
12407	30mm	43gr	250x

REF	⊖	ℓ	TIPO	FACES/ CARAS	⚖	📦
6160Q08L	8mm	75mm	LONGO/LARGA	Quadrado/Cuadrado	20gr	300x
6160Q10L	10mm	75mm	LONGO/LARGA	Quadrado/Cuadrado	20gr	300x
6160CPH2	PH2	30mm	CURTO/CORTA	Phillips	12gr	200x

 **Bit 1/4" com ponta roscada**
 **Punta 1/4" roscada para tornillos**



REF	⊖	⚖	📦
1902M6	M6	4gr	200x
1902M8	M8	4gr	200x

 **Adaptador para bits 1/4" articulado**
 **Adaptador para puntas 1/4" articulado**



REF	ℓ	⚖	📦
5776	135mm	50gr	1x

 **Adaptador de 1/4" para bits 1/4"**
 **Adaptador de 1/4" para puntas 1/4"**



REF	ℓ	⚖	📦
14206	25mm	20gr	250x

 **Adaptador 3/8" de bits 10mm para jogo 6160**
 **Adaptador 3/8" de puntas 10mm para juego 6160**



REF	ℓ	⚖	📦
6160AD38	30mm	50gr	200x

Adaptador 1/2" para bits 5/16"
 Adaptador 1/2" para puntas 5/16"



REF	∅	⏱	📄
12408	30mm	40gr	250x

Adaptador 1/2" para jogo 6160
 Adaptador 1/2" juego 6160



REF	∅	⏱	📄
6160AD12	30mm	50gr	1x

Adaptador 1/2" para bits 10mm
 Adaptador 1/2" para puntas 10mm



REF	∅	⏱	📄
12410	30mm	55gr	100x

Punho com adaptador de bits 1/4"
 Mango con adaptador de puntas 1/4"



REF	↔	⏱	📄
14149	210mm	100gr	1x

Jogo de 100 peças bits 1/4"
 Juego de 100 piezas puntas 1/4"



3x		1,2,3mm
3x		6, 8, 10mm
3x		M5, M6, M8
4x		1, 2, 3, 4mm
4x		0, 1, 2, 3mm
4x		4, 6, 8, 10mm
9x		3, 4, 4.5, 5, 5.5, 6, 6.5, 7, 8mm

8x		PH0, PH1, PH2(X5), PH3
8x		PZ0, PZ1, PZ2(X5), PZ3
9x		1.5, 2, 2.5, 3, 4, 5, 5.5, 6, 8mm
10x		1/16", 5/64", 3/32", 7/64", 1/8", 9/64" 5/32", 3/16", 7/32", 1/4"
6x		2, 2.5, 3, 4, 5, 6mm
6x		5/32", 9/64", 1/8", 7/64", 3/32" 5/64"
9x		T8, 10, 15, 20, 25, 27, 30, 40, 45
9x		T8H, T10H, T15H, T20H, T25H, T27H, T30H, T35H, T40H
1x		Adaptador fêmeas orelhas Adaptador hembra con orejas
1x		1/4" 25mm
2x		1/4" x 25mm, 1/4"x 50mm
1x		1/4" 60mm

REF	∅	⏱	📄
2100	1/4"	700gr	20x

 Jogo de 60 peças bits curtos e longos 10mm
 Juego de 60 piezas puntas cortas y largas 10mm



1x		3/8" x 10mm / 30mm
1x		1/2" x 10mm / 30mm
2x	 	8, 10mm
4x	 	R6, R8, R10, R12
9x	 	T20, T25, T27, T30, T40, T45, T50, T55, T60
9x	 	4, 5, 6, 7, 8, 9, 3/8", 10, 12
8x	 	M5, M6, M8, M9, M10, M12, M14, M16
9x	 	T20, T25, T27, T30, T40, T45, T50, T55, T60
5x	 	M5, M6, M8, M10, M12
10x	 	4, 5, 6, 7, 8, 9, 10, 12, 14, 17
1x	 	8mm
1x	 	PH2

REF			
6160	10mm	2,8kg	8x

 Jogo de 75 peças bits 10mm
 Juego de 75 piezas puntas 10mm



8x	 	R5, R6, R7, R8, R9, R10, R12, R14
5x	 	M5, M6, M8, M10, M12
7x	 	4, 5, 6, 7, 8, 10, 12mm
8x	 	T20, T25, T30, T40, T45, T50, T55, T60
8x	 	T20H, T25H, T30H, T40H, T45H, T50H, T55H, T60H
8x	 	R5, R6, R7, R8, R9, R10, R12, R14
5x	 	M5, M6, M8, M10, M12
7x	 	4, 5, 6, 7, 8, 10, 12mm
8x	 	T20, T25, T30, T40, T45, T50, T55, T60
8x	 	T20H, T25H, T30H, T40H, T45H, T50H, T55H, T60H
1x		3/8" x 10mm
2x		1/2" x 10mm

REF			
6145	10mm	3,5kg	5x



 Jogo chaves 1/4" com bit torx inviolável 
 Juego llaves 1/4" con punta torx inviolable



Medidas: T10, T15, T20, T25, T27, T30, T40, T45, T50

REF



2356

204gr

48x



 Jogo 9 chaves 1/4" com bit torx inviolável 5PT 
 Juego 9 llaves 1/4" con punta torx inviolable 5PT



Medidas: TS T10, T15, T20, T25, T27, T30, T40, T45, T50

Aplicação: Usado na industria eletrónica automóvel como por exemplo medidores de fluxo Bosch e caixas de velocidades



Medidas: TS T10, T15, T20, T25, T27, T30, T40, T45, T50

Aplicación: Usado en la industria electrónica automóvil como por ejemplo medidores de flujo Bosch y cajas de velocidades

REF



2355

204gr

48x



 Régua 11 chaves de caixa 1/4", 3/8" com bit torx 
 Juego 11 llaves de vaso 1/4", 3/8" con punta torx



Composição:

(6x) Chaves de caixa 1/4" com bit torx: T10, T15, T20, T25, T27, T30
 (5x) Chaves de caixa 3/8" com bit torx: T40, T45, T50, T55, T60



Composición:

(6x) Llaves de vaso 1/4" con punta torx: T10, T15, T20, T25, T27, T30
 (5x) Llaves de vaso 3/8" con punta torx: T40, T45, T50, T55, T60

REF



1239

1,7kg

1x



 Kit chaves caixa 3/8 com bit torx plus 9 peças 
 Kit llaves vaso 3/8" con punta torx plus 9 piezas



Medidas: TP10, TP15, TP20, TP25, TP27, TP30, TP40, TP45 TP50
Altura: 48mm



Medidas: TP10, TP15, TP20, TP25, TP27, TP30, TP40, TP45 TP50
Altura: 48mm

REF



2370

48mm

408gr

24x



 Kit chaves caixa 1/2" com bit torx plus 6 peças 
 Kit llaves vaso 1/2" con punta torx plus 6 piezas



Medidas: TP45, TP50, TP55, TP60, TP70, TP80
Altura: 55mm



Medidas: TP45, TP50, TP55, TP60, TP70, TP80
Altura: 55mm

REF



2375

55mm

612gr

24x

 Jogo de 14 peças bits ribe 10mm 
 Juego de 14 piezas puntas ribe 10mm



6x			R5, R6, R7, R8, R10, R12
7x			R7, R8, R9, R10, R12, R13, R14
1x			1/2" x 10mm

REF			
3114	10mm	875gr	20x

<p>Bit / Punta R6</p>  <p>REF 3114-M6</p>	<p>Bit / Punta R7</p>  <p>REF 3114-M7</p>	<p>Bit / Punta R8</p>  <p>REF 3114-M8</p>
<p>Bit / Punta R9</p>  <p>REF 3114-M9</p>	<p>Bit / Punta R12</p>  <p>REF 3114-M12</p>	<p>Bit / Punta R14</p>  <p>REF 3114-M14</p>

 Kit pernos anti roubo 11 peças
 Set de tornillos seguridad 11 piezas



 **Diâmetros internos:** Ø 18.3 x Ø 16.4mm, Ø 19.5 x Ø 17.6mm, Ø 20.4 x Ø 18.5mm, Ø 21.6 x Ø 19.7mm, Ø 22.5 x Ø 20.6mm, Ø 25.5 x Ø 23.6mm, Ø 23.6 x Ø 21.7mm, Ø 24.5 x Ø 22.6mm

 **Diámetros interiores:** Ø 18.3 x Ø 16.4mm, Ø 19.5 x Ø 17.6mm, Ø 20.4 x Ø 18.5mm, Ø 21.6 x Ø 19.7mm, Ø 22.5 x Ø 20.6mm, Ø 25.5 x Ø 23.6mm, Ø 23.6 x Ø 21.7mm, Ø 24.5 x Ø 22.6mm

REF			
3053	60mm	2,6kg	10x

 Kit bits impacto 3/4" 12 peças  
 Kit puntas impacto 3/4" 12 piezas



5x			14, 17, 19, 21, 22mm
4x			T70, T80, T90, T100
1x			3/4" 200mm
1x			3/4" x 1/2"
1x			1" x 3/4"

REF			
6159	3/4"	3,1kg	5x

 Kit universal desmontar porcas rodas anti-roubo
 Kit universal desmontar tornillos ruedas



	BMW, Ford, Opel, PSA, VAG, Volvo
---	----------------------------------

 **Descrição:** Para a desmontagem de porcas com rosca direita no caso de porcas de jantes defeituosas ou das chaves especiais perdidas
Possibilita desapertar e desmontar mais de 24 tipos diferentes de porcas e os seus subgrupos com muitos perfis de bloqueio

 **Descripción:** Para retirar las tuercas roscadas de la derecha en caso de tuercas de llanta defectuosas o llaves especiales perdidas
Permite deshacer y quitar más de 24 tipos diferentes de tuercas y sus subgrupos con muchos perfiles de bloqueio

REF			
3078	2,25kg		2x

-  Kit chaves caixa extradoras 1/2" 5 peças 17-22mm
 Kit llaves vaso extradoras 1/2" 5 piezas 17-22mm



-  **Medidas:** 17, 19, 21, 22mm
Descrição:
 Pino impacto com diâmetro 12mm
 Para remover porcas gastas ou danificadas
 Possibilidade de usar com máquinas de impacto

-  **Medidas:** 17, 19, 21, 22mm
Descripción:
 Perno impacto con diámetro 12mm
 Para quitar tuercas gastadas o dañadas
 Posibilidad de utilizar con máquinas de impacto

REF		
3075	850gr	20x

-  Kit chaves caixa extradoras 1/2" 6 peças 17-27mm
 Kit llaves vaso extradores 1/2" 6 piezas 17-27mm



-  **Medidas:** 17, 19, 21, 22, 27mm.
Descrição:
 Pino impacto diâmetro 12mm
 Para remover porcas gastas ou danificadas
 Possibilidade de usar com máquinas de impacto

-  **Medidas:** 17, 19, 21, 22, 27mm.
Descripción:
 Perno impacto con diámetro 12mm
 Para quitar tuercas gastadas o dañadas
 Posibilidad de utilizar con máquinas de impacto

REF		
3076	1,1kg	20x

-  Jogo 8 chaves de caixa 1/2" anti-roubo
 Juego 8 llaves de vaso 1/2" anti-robo



8x		1/2": 17, 18.5, 20, 21.5, 23, 24.5, 26, 27.5mm
----	---	--

REF		
3052	1,3kg	10x

-  Jogo 8 peças torx 5PT-6PT
 Juego 8 destornilladores torx 5PT-6PT

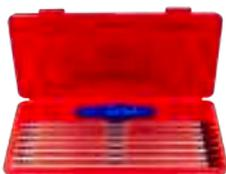

-  **Descrição:**
 Medidas Torx TS: T10, T15, T20, T25, T27, T30, T40
 Comprimento varetas: 300mm, comprimento punho: 112mm

-  **Descripción:**
 Medidas Torx TS: T10, T15, T20, T25, T27, T30, T40
 Longitud varillas: 300mm, longitud mango: 112mm

vareta/varilla TS10



REF 9239-T10

vareta/varilla TS15



REF 9239-T15

vareta/varilla TS20



REF 9239-T20

vareta/varilla TS25



REF 9239-T25

vareta/varilla TS27



REF 9239-T27

vareta/varilla TS30



REF 9239-T30

vareta/varilla TS40



REF 9239-T40

Punho / mango



REF 9239P

REF		
9239	916gr	18x

 Jogo 6 peças desaparafusador e bits
 Juego 6 piezas destornillador y puntas



 **Descrição:**
Quadra superior 1/2"
(4x) Bits SL8, SL10, PH2, PH3

 **Descripción:**
Cuadrado superior 1/2"
(4x) Puntas SL8, SL10, PH2, PH3

REF	⊕	⊖	⚖	📦
2001		15/16"	950gr	20x

 Chave de caixa 1/2" especial 17mm rodas Mercedes
 Llave de vaso 1/2" especial 17mm ruedas Mercedes



 **Aplicação:** Maybach, W221 (Classe S) e modelos mais recentes Classe CL, Mercedes com parafusos especiais Mercedes (Mercedes # 000 990 5407)

 **Aplicación:** Maybach, W221 (Clase S) y modelos mas recientes Clase CL, Mercedes con tornillos especiales Mercedes (Mercedes # 000 990 5407)

REF	⊕	⊖	⚖	📦
7005		25mm	45mm	200gr
				1x

 Jogo 3 chaves caixa 1/2" para jantes alumínio
 Juego 3 llaves vaso 1/2" para llantas aluminio



Chave / Llave 17mm



REF 700317

Chave / Llave 19mm



REF 700319

Chave / Llave 21mm



REF 700321

 **Aplicação:** Chaves de caixa com parede fina para desapertar as porcas das rodas

 **Aplicación:** Llaves de vaso con pared delgada para aflojar las tuercas de las ruedas

REF	⊕	⊖	⚖	📦
7003		17/19/21mm	825gr	20x

 Desmultiplicador 4800Nm relação 1:68 1"
 Multiplicador de par 4800Nm relación 1:68 1"



 **Composição:**
(1x) Chave de caixa hexagonal 1" 32mm
(1x) Chave de caixa hexagonal 1" 33mm
(1x) Desmultiplicador
(1x) Barra de Conexão
(1x) Pega

 **Composición:**
(1x) Llave de vaso hexagonal 1" 32mm
(1x) Llave de vaso hexagonal 1" 33mm
(1x) Multiplicador
(1x) Barra de conexión
(1x) Mango

REF	⚖	📦
8201	8,3kg	3x

-  Desmultiplicador 6200nm relação 1:68 1"
 Multiplicador de par 6200nm 1:68 1"



-  **Composição:**
 (1x) Pé de apoio
 (2x) Casquilhos: 32 mm e 33 mm
 (1x) Extensão
 (1x) Braço móvel

-  **Composición:**
 (1x) Pie de apoyo
 (2x) Casquillos: 32 mm y 33 mm
 (1x) Palo largo
 (1x) Brazo giratorio

REF		
8203	8,5kg	3x

-  Chave de rodas tubo hexagonal
 Llave de ruedas tubular hexagonal



Barra 19x400mm chave rodas
 Barra 19x400mm llave de rueda



REF 3063

REF				
3060	24x27	400mm	600gr	1x
3061	30x32	400mm	600gr	1x
3062	32x33	400mm	2,1kg	10x

-  Chave de rodas tubo hexagonal com barra
 Llave de ruedas tubular hexagonal con barra



REF				
3064	24x27	400mm	710gr	1x
3065	30x32	400mm	710gr	1x
3066	32x33	400mm	710gr	1x

-  Jogo de 10 bits xzn furados BMW 
 Juego de 10 puntas xzn inviolables BMW



10x			xzn: B30/13P, B31/15P, B32/16P, B33/17P, B34/18P B35/19, B36/20P, B37/21P, B38/22P, B40/23P
-----	---	--	---

REF			
3056	17mm	746gr	1x

-  Jogo de 10 bits xzn grupo VAG 
 Juego de 10 puntas xzn grupo VAG



8x			xzn: ABC0/10P, ABC1/11P, ABC2/13P, ABC3/14P, ABC4/15P, ABC5/16P, ABC6/17P, ABC7/19P, ABC8/20P, ABC9/21P
----	---	--	---

REF			
3057	17mm	750gr	10x

 Jogo de 10 bits ribe BMW 
 Juego de 10 puntas ribe BMW



10x	 	Ribe: B11 / 15 ribe, B12 / 14 ribe, B13 / 16 ribe, B14 / 12 ribe, B15 / 11 ribe, B16 / 10 ribe, B17 / 7 ribe, B18 / 13 ribe, B19 / 8 ribe, B20 / 9 ribe
-----	---	---

 **Aplicação:**
Usar com chave de caixa hex. 17mm

 **Aplicación:**
Usar con llave de vaso hex. 17mm

REF			
3058	17mm	746gr	1x

 Jogo 3 chaves 1/2" especiais parafusos trincos BMW
 Juego 3 llaves 1/2" especiales pernos BMW



3x		1/2": 17Fx14,5mm, 10Fx16mm, 21Fx16,5mm
----	--	--

REF			
3350	100mm	700gr	1x

 Jogo 23 peças bits xzn e ribe furados grupo VAG  
 Juego 23 piezas puntas xzn y ribe inviolables grupo VAG



12x	 	B51 / ribe 6, B52 / ribe 7, B53 / ribe 8, B54 / ribe 9, B55 / ribe 10, B56 / ribe 11, B57 / ribe 12, B58 / ribe 13, B59 / ribe 14, B60 / ribe 15, B61 / ribe 16, B62 / ribe 17
10x	 	xzn: ABC0/10P, ABC1/11P, ABC2/13P, ABC3/14P, ABC4/ 15P, ABC5/16P, ABC6/17P, ABC7/19P, ABC8/20P, ABC9/21P
1x		1/2" 17mm HEX

REF			
3059	17mm	746gr	10x

 Jogo 8 chaves 1/2" especiais para colaça    
 Juego 8 llaves 1/2" especiales para culatas



3x	 	1/2" ribe: R10x140mm, R12x65mm, R12x120mm
1x	 	1/2" hex: 10x140mm
2x	 	1/2" xzn: M10x140mm, M14x100mm
1x	 	1/2" torx: T60x140mm
1x	 	1/2" torx interior: E12x140mm

REF		
6093	1,9kg	10x



Jogo 39 chaves para colaças

Juego 39 llaves para culatas



Ribe R8x240mm



REF 6094-37

Torx ST T30x295mm



REF 6094-38

Ribe R10x140mm



REF 6094-34

Hex. 7x240mm



REF 6094-35

Ribe R7x240mm

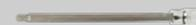

REF 6094-36

XZN M10x140mm



REF 1211410

XZN M12x140mm



REF 1211412

XZN M14x140mm



REF 1211414

Hex 11x140mm



REF 6094-22

Hex 13x140mm



REF 6094-23

Hex 5x140mm



REF 6094-24

Torx ST T55x140mm



REF 6094-28

Torx ST T60x140mm



REF 6094-29

Torx ST T70x140mm

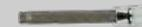

REF 6094-30

XZN M16x100mm



REF 1211016

Ribe R9x100mm



REF 123109

Hex 10x140mm



REF 1261410

Torx ST T40x140mm

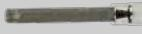

REF 6094-25

Torx ST T45x140mm



REF 6094-26

Torx ST T50x140mm

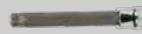

REF 6094-27

XZN M18x75mm



REF 6094-16

Torx ST T80x100mm



REF 6094-17

XZN M9x100mm



REF 1211009

Hex. 22x55mm



REF 6094-13

Hex. 24x55mm



REF 6094-14

XZN M16x55mm



REF 6094-15

Hex. 14x60mm



REF 126014

Hex. 17x60mm



REF 126017

Hex. 19x50mm



REF 126019

1/2" Hex. 10x140mm



REF 6094-21

1/2" XZN M10x140mm



REF 6094-31

1/2" XZN M12x140mm



REF 6094-32

Composição:

(6x) Chaves de caixa 1/2" com bit torx 140mm: T40, T45, T50, T55, T60, T70
 (2x) Chave de caixa com bit torx furado 100mm: T52, T80H
 (1x) Chave de caixa com bit torx furado 300mm: T30H
 (3x) Chaves de caixa 1/2" bit xzn 140mm: M10, M12, M14
 (1x) Chave de caixa 1/2" com bit xzn 55mm: M16H
 (2x) Chave de caixa 1/2" com bit xzn 100mm: M9, M16
 (1x) Chave de caixa 1/2" xzn impacto 78mm: M18
 (1x) Chave de caixa 1/2" com bit ribe 100mm: R9
 (1x) Chave de caixa 1/2" com bit 140mm: M10
 (2x) Chaves de caixa 1/2" com bit ribe 240mm: R7, R8
 (3x) Chaves de caixa 1/2" com bit hexagonal 140mm: 10, 11, 13mm
 (1x) Chave de caixa 1/2" com bit hexagonal 230mm: 7mm
 (5x) Chaves de caixa com bit hexagonal 55mm: 14, 17, 19, 22, 24mm
 (1x) Chave de caixa 1/2" com bit hexagonal esférico 5x160mm
 (9x) Chaves de caixa 1/4" com bit torx furado 37mm: T10H, T15H, T20H, T25H, T27H, T30H, T40H, T45H, T50H

Composición:

(6x) Llaves de vaso 1/2" con punta torx 140mm: T40, T45, T50, T55, T60, T70
 (2x) Llave de vaso con punta torx inviolable 100mm: T52H, T80
 (1x) Llave de vaso con punta torx inviolable 300mm: T30H
 (3x) Llaves de vaso 1/2" con punta xzn 140mm: M10, M12, M14
 (1x) Llave de vaso 1/2" con punta xzn 55mm: M16H
 (2x) Llave de vaso 1/2" con punta xzn 100mm: M9, M16
 (1x) Llave de vaso 1/2" xzn impacto 78mm: M18
 (1x) Llave de vaso 1/2" con punta ribe 100mm: R9
 (1x) Llave de vaos 1/2" con punta 140mm: M10
 (2x) Llaves de vaso 1/2" con punta ribe 230mm: R7, R8
 (3x) Llaves de vaso 1/2" con punta hexagonal 140mm: 10, 11, 13mm
 (1x) Llave de vaso 1/2" con punta hexagonal 230mm: 7mm
 (5x) Llaves de vaso con punta hexagonal 55mm: 14, 17, 19, 22, 24mm
 (1x) Llave de vaso 1/2" con punta hexagonal esférica 5x160mm
 (9x) Llaves de vaso 1/4" con punta torx inviolable 37mm: T10H, T15H, T20H, T25H, T27H, T30H, T40H, T45H, T50H

REF

6094



6,4kg



4x

FERRAMENTA ESPECÍFICA
HERRAMIENTA ESPECÍFICA

04



KROFtools[®]
PROFESSIONAL TOOLS

 FAMÍLIA	PÁGINAS
01 FERRAMENTA MANUAL	11-106
02 ALICATES	109-120
03 BITS E CONJUNTOS	123-134
04 FERRAMENTA ESPECÍFICA	137-214
05 FERRAMENTA CARROÇARIA	217-222
06 REGULAÇÃO E TESTE	225-246
07 FERRAMENTA MOTOR	249-276
08 KITS SINCRONIZAÇÃO	279-350
09 FERRAMENTA ELÉTRICA	353-362
10 FERRAMENTA PNEUMÁTICA	365-378
11 FERRAMENTA HIDRÁULICA	381-404
12 FERRAMENTA LUBRIFICAÇÃO	407-414
13 EQUIPAMENTO GARAGEM	417-502
RT ROUPA DE TRABALHO	505-508
MR MERCHANDISING	511-514
EP EXPOSITORES	517-524
LR LOCALIZAÇÃO REFERÊNCIAS	527-538

 FAMILIA	PÁGINAS
01 HERRAMIENTA MANUAL	11-106
02 ALICATES	109-120
03 PUNTAS Y CONJUNTOS	123-134
04 HERRAMIENTA ESPECÍFICA	137-214
05 HERRAMIENTA DE CARROCERIA	217-222
06 REGULACIÓN Y PRUEBAS	225-246
07 HERRAMIENTA PARA MOTOR	249-276
08 KIT CALADO	279-350
09 HERRAMIENTA ELÉCTRICA	353-362
10 HERRAMIENTA NEUMÁTICA	365-378
11 HERRAMIENTA HIDRÁULICA	381-404
12 HERRAMIENTA LUBRICACIÓN	407-414
13 EQUIPAMENTO PARA TALLER	417-502
RT ROPA DE TRABAJO	505-508
MR MERCHANDISING	511-514
EP EXPOSITORES	517-524
LR LOCALIZACIÓN REFERENCIAS	527-538



Capa proteção frontal universal
Protector cubre aletas universal



Descrição:
Velcro ajustável para retrovisores laterais
Nylon lavável
Capa de malha para radiador
Recorte transparente para faróis

Descripción:
Velcro ajustable para espejos laterales
Nailon lavable
Cubierta de malla para radiador
Recorte transparente para faros

REF		
0014	740gr	20x

Protetor de guarda lamas
Protector magnetico cubre aletas



REF			
0013	1200X1000mm	900gr	20x

Íman flexível com led 600mm 1.5kg
Imán flexible con led 600mm 1.5kg



REF				
2335	1500gr	17,5mm	166gr	48x

Íman flexível 300gr
Imán flexible 300gr



REF				
2331	300gr	510mm	109gr	100x

Espelho inspeção flexível
Espejo inspección flexible



REF				
2146	55mm	470mm	105gr	120x

Íman extensível 500mm 500gr
Imán extensible 500mm 500gr



REF				
2336	500gr	7mm	66,67gr	120x

 Espelho inspeção telescópico com LED 285-870mm

 Espejo inspección telescópico con LED 285-870mm



 Extensível: 285-870mm

 Extensible: 285-870mm

REF	↔	⚖	📦
2340	41x62mm	133gr	60x

 Espelho inspeção telescópico extensível 280-430mm

 Espejo inspección telescópico extensible 280-430mm



 Extensível: 280-430mm

 Extensible: 280-430mm

REF	↔	⚖	📦
2341	50mm	66,67gr	120x

 Espelho inspeção telesc. 30mm extensível 170-495mm

 Espejo inspección telesc. 30mm extensible 170-495mm



 Extensível: 170-495mm

 Extensible: 170-495mm

REF	↔	⚖	📦
2342	30mm	37,5gr	120x

 Pega longa flexível com ímã e led

 Garra larga flexible con imán y led



 Características:

Comprimento: 600mm

Diâmetro extremidade: 15mm

Diâmetro abertura garra: 25mm

Capacidade magnética: 680gr

 Características:

Largo: 600mm

Diâmetro final: 15mm

Diâmetro abertura garra: 25mm

Capacidade magnética: 680gr

REF	⚖	↔	⚖	📦
2338	680gr	600mm	120gr	100x

 Pega de 4 garras 300mm

 Pega de 4 garras 300mm



 Características:

Comprimento: 300mm

Diâmetro extremidade: 15mm

Diâmetro abertura garra: 25mm

 Características:

Largo: 300mm

Diâmetro final: 15mm

Diâmetro abertura garra: 25mm

REF	↔	⚖	📦
2339	330mm	100gr	100x

 Ímã flexível com pinça e luz 3 em 1

 Imán flexible con pinza y luz



 Descrição:

Ferramenta útil 3 em 1: garra, ímã, luz
Comprimento total com luz: 585mm

 Descripción:

Herramienta útil 3 en 1: pinza, imán, luz
Longitud total con luz: 585mm

REF	⚖	📦
2333	270gr	48x

 Kit estrangulador fluídos tubo
 Kit 4 Abrazaderas de línea de Acero



 **Especificações:** Banjo, 3/8", 5/16", 1/2"
Descrição:
Utilizado para ligar tubos de aço uma vez desconectados
Evita fugas de líquidos e contaminação durante a utilização

 **Especificaciones:** Banjo, 3/8", 5/16", 1/2"
Descripción:
Se utiliza para conectar tubos de acero una vez desconectados
Evita fugas de líquido y contaminación durante su uso

REF		
6255	135gr	20x

 Kit 4 bandejas magnéticas
 Kit 4 bandejas imantadas

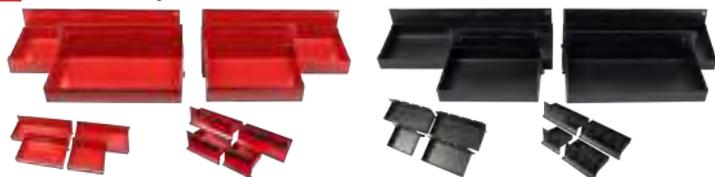

 **Dimensões:**
110x150mm, 110x210mm, 110x270mm, 110x310mm
Nota: Disponível na cor preta ou vermelha

 **Dimensiones:**
110x150mm, 110x210mm, 110x270mm, 110x310mm
Nota: Disponible en color negro o rojo

REF		
8609	3kg	4x

 Bandeja magnética
 Bandeja imantada



REF			
9404	240x140mm	625gr	24x

 Bandeja metálica para peças
 Bandeja metálica para piezas



 **Dimensões:** 450x330x90mm **Material:** Folha galvanizada

 **Dimensiones:** 450x330x90mm **Material:** Hoja galvanizada

REF		
8939	1,7kg	10x

 Bandeja magnética retrátil
 Bandeja imantada retráctil



REF			
9405	225mm	458gr	24x

 Aparador óleo 15L
 Recogedor aceite 15L

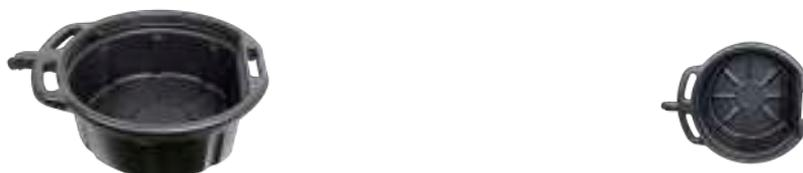

REF				
2044	420mm	178mm	1kg	8x

 Chave para pólia alternador xzn M10 

 Llave para polea alternador xzn M10



Adaptador XZN M10



REF 3307A



VAG, PSA, Mercedes, Ford, Fiat, Alfa Romeo, BMW, alternadores BOSCH

REF



3307

M10

113mm

175gr

60x

 Chave para polias alternador M10 

 Llave para poleas alternador M10



Bit / punta hex. 10mm



REF 3306BIT



Mercedes Classe A, alternadores BOSCH



Adaptador: 33 dentes/dientes

REF



3306

M10

90mm

200gr

1x

 Chave para polia alternador torx 1/2" T50 

 Llave para polea alternador torx 1/2" T50



Bit / punta 5/16" T50



REF 3310-T50



Mercedes Classe A, alternadores BOSCH



Adaptador: 33 dentes/dientes

REF



3404

T50

113mm

170gr

40x

 Adaptador para martelo pneumático para extração injetores

 Adaptador de martillo neumatico para extractor de inyectores



 **Descrição:**

O adaptador permite que o martelo pneumático seja utilizado por vibração e soltar o injetor, em vez de utilizar um martelo deslizante. Ideal para injetores presos, quando é necessário um método alternativo de remoção. Fornecido em estojo de armazenamento. Tamanho do adaptador de haste: .401" Parker Taper

 **Descripción:**

El adaptador permite utilizar el martillo neumático para hacer vibrar y liberar el inyector, en lugar de utilizar un martillo deslizante. Ideal para inyectores atascados que requieren un método alternativo de extracción. Se suministra en estuche. Tamaño del adaptador de varilla: .401" Parker Taper de extracción

REF



8458

1,4kg

10x

 Kit escovas limpeza injetores diesel 3pcs
 Kit escobillas limpieza de inyectores diesel 3pzs



 **Especificações:**
Escova de tubo longo em espiral: 150mm de comprimento da escova, 25 mm de largura da escova, 290mm de comprimento total
Escova de tubo em espiral: 80mm de comprimento da escova, 35mm de largura da escova, 275mm de comprimento total
Escova de fundo plano: 50mm de comprimento da escova, 17mm de largura da escova, 260mm de comprimento total

 **Especificações:**
Cepillo de tubo en espiral largo: 150mm de longitud de cepillo, 25mm de anchura de cepillo, 290mm de longitud total
Cepillo de tubo en espiral: 80mm de longitud de cepillo, 35mm de anchura de cepillo, 275mm de longitud total
Cepillo de fondo plano: 50mm de longitud de cepillo, 17mm de anchura de cepillo, 260mm de longitud total

REF

4404



281gr



48x

 Kit escovas limpeza 6pcs
 Kit escobillas limpieza 6pzs



 **Especificações:**
Diâmetros de 13, 19, 25, 31, 41 e 50mm, com orifícios para pendurar facilitando o armazenamento conveniente
Comprimento total: 153mm

 **Especificaciones:**
Diámetros de 13, 19, 25, 31, 41 y 50mm, con orifícios para colgar y guardar cómodamente
Longitud total: 153mm

REF

4407



177gr



48x

 Jogo limpeza pernos da roda 9pcs
 Juego limpieza de pernos de rueda 9pzs



 **Especificações:**
(6x) Cabeças de limpeza: 12mm (7/16"), 13mm (1/2"), 14mm (9/16"), 16mm (5/8"), 22mm (7/8"), 28mm (1-1/8")
(1x) Adaptador de encaixe rápido com quadra 1/2"
(1x) Adaptador 1/4" hex para quadra 1/2"
(1x) Adaptador SDS para quadra 1/2"

 **Especificações:**
(6x) Cabezales de limpieza: 12mm (7/16"), 13mm (1/2"), 14mm (9/16"), 16mm (5/8"), 22mm (7/8"), 28mm (1-1/8")
(1x) Adaptador rápido con escuadra de 1/2"
(1x) Adaptador hexagonal de 1/4" para escuadra de 1/2"
(1x) Adaptador SDS para escuadra de 1/2"

REF

6306



800gr



10x

 Jogo limpeza pernos da roda 9pcs
 Juego limpieza de pernos de rueda 9pzs



Bit / punta hex. 10mm



REF 9073-01

 **Características:**
Diâmetro externo: 150 mm
Diâmetro interno: 90 mm
Velocidade máxima de rotação: 1500 RPM

 **Características:**
Diámetro exterior: 150 mm
Diámetro interior: 90 mm
Velocidad máxima de rotación: 1500 RPM

REF

9073



608gr



24x

 Jogo 6 peças para polias alternador Renault  
 Juego 6 piezas para poleas alternador Renault



Bit / punta T50

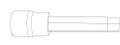

REF 3310-T50C

1x			1/2" xzn M10 100mm
1x			1/2" xzn M10 140mm
1x			Adaptador sextavado / Adaptador hexagonal
1x			Adaptador estriado / Adaptador bihexagonal
1x			T50
1x			xzn M10

REF

3309



1,3kg



5x

 Jogo 23 peças chaves para polias alternador   
 Juego poleas alternador 23 pzs

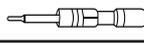
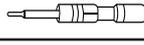
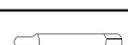
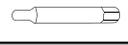
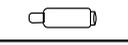

1x		1/2" torx T50 110mm
1x		1/2" xzn M10 110mm
1x		3/8" xzn M10 88mm
1x		1/2" xzn M10 140mm
1x		Hex. 15x19mm 33 dentes/dientes
1x		Hex. 22mm 33 dentes/dientes
1x		Hex. 15x17mm 33 dentes/dientes
1x		1/2" hex. 21mm
1x		1/2" hex. 17mm
1x		1/2" hex. 22x28mm
1x		1/2" hex. 22x28mm 33 dentes//dientes
1x		1/2" hex. 19x28mm
1x		Chave/Llave especial 35mm 4 pinos
1x		Chave/Llave especial 38mm 3 pinos
1x		Adaptador 1/2" para bits/puntas 10mm
1x		10mm xzn M10: 64mm
1x		10mm torx: T40 75mm
1x		10mm torx: T50 75mm
1x		10mm xzn M8: 75mm
1x		10mm xzn M10: 75mm
1x		hex. H8: 75mm
1x		hex. H10: 75mm
1x		hex. H17x35x15

Bit / Punta 10X75 H8



REF 3311H08

Bit / Punta 10X75 H10



REF 3311H10

Bit / Punta 10X75 M8



REF 3311M08

Bit / Punta 10X75 M10



REF 3311M10

Bit / punta 10X75 T40



REF 3311T40

Bit / punta 10X75 T50



REF 3311T50

REF

3311



4kg



2x

 Jogo 30 peças chaves para polias alternador
 Juego 30 piezas llaves para poleas alternador

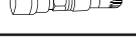

2x		xzn M8, M10 75mm	1x		22mm 33 dentes/dientes
2x		T40, T50 75mm	1x		17x15mm
2x		Hex. 8,10mm	1x		1/4" hex 10mm
2x		10x71mm, 10x50mm	1x		Hex. 17mm
1x		1/2" xzn M10 110mm	1x		Hex. 22mm
1x		1/2" xzn M10 140mm	1x		Hex. 28x22mm
1x		xzn M10 64mm	1x		Hex. 28x22mm
1x		3/8" xzn M10x87mm 31 dentes/dientes	1x		Hex. 28x19mm
1x		1/2" hex. 8mm 110mm	1x		Hex. 17x19mm
1x		1/2" torx T50 110mm	1x		Hex. 17x21mm
1x		(L) 15mm 33 dentes/dientes	1x		Hex. 17mm 4 pinos
1x		(S) 15mm 33 dentes/dientes	1x		Hex. 38mm 3 pinos
1x		17mm 33 dentes/dientes	1x		Adaptador 1/2" bits 10mm

REF
3312

2,4kg

5x

 Alinhador de embraiagem universal
 Alineador de embrague universal



 **Características:** Para alinhar o conjunto da embraiagem e o seu mecanismo antes da montagem
 Adaptadores: 14-28mm. Cone: 35-67mm

 **Características:** Para alinear el conjunto del embrague y el suyo mecanismo antes del montaje
 Adaptadores: 14-28mm. Cono: 35-67mm

REF
3111

150gr

24x

 Ferramenta alinhar embraiagem universal
 Herramienta alinear embrague universal



 **Aplicação universal:** Para ligeiros e pequenos camiões (abaixo de 3500cc)

Adaptadores: 10, 12, 14, 15, 16, 17, 19, 25, 27, 30

 **Aplicación universal:** Para automóviles y camiones pequeños (menos de 3500cc)

Adaptadores: 10, 12, 14, 15, 16, 17, 19, 25, 27, 30

REF



3113

2,44kg

10x

 Jogo para montagem e desmontagem embraiagens SAC
 Juego compresor de embragues SAC



SAC 3/4 furos/agujeros VAG, Mercedes, Opel, Volvo, Renault.

Audi A3, A4, A6, A8; VW Passat, Golf Sharan, Tiguan; Ford Mondeo, S-Max, Galaxy, Transit; Mercedes C E, CLS, S, CLK, SLK, SL, BMW 320, 330, 520, 530; Alfa Romeo 147 159, 166; Fiat Ulysse, Croma, Ducato, Lancia Phedra, Thesis

REF



3118

9,3kg

1x

 Jogo para montagem e desmontagem embraiagem
 Juego centrador de embragues



Audi, BMW, Fiat, Mercedes Renault, Opel, Volvo



Descrição/Descripción: Ferramenta especializada para compressão de embraiagens autoajustáveis / Herramienta especializada para la compresión de embragues autoajustables Audi, BMW, Fiat, Mercedes Renault, Opel e Volvo

REF



3112

10,5kg

1x

 Instalação / remoção transmissão dupla embraiagem DPS6
 Instalación / remoción transmisión doble embrague DPS6



	Volvo, Ford, transmissão/transmisión DPS6
	307675

REF		
3119	11kg	2x

 Kit reset embraiagem dupla Ford powershift
 Kit reset embrague doble Ford powershift



	Ford Transit Connect (2014-), Fiesta (2008-), Focus (2010-), B-Max (2012-)
	307-676

REF		
3121	7,1kg	1x

 Kit desmontagem carcaça DSG VAG
 Kit desmontaje cuerpo DSG VAG



	Land Rover, Volvo, Mazda
---	--------------------------

 **Descrição:** Ferramenta para desmontagem da carcaça de transmissão automática DSG VW Oam

 **Descripción:** Herramienta para desmontar cuerpo de la transmisión automática DSG VW Oam

REF		
3122	5kg	2x

 Kit desmontar embraiagem 7vel. DSG grupo VAG

 Kit para embragues 7 vel. DSG VAG

	VW Golf (2004-), Golf Plus (2005-) Audi A3 (2004-) caixa/caja 7 velocidades (código 0 AM) Touareg (2003-) caixa/caja 6 velocidades (código 08 D)
OEM	T10323, T10373, T10374

REF

3116



5,5kg



2x

 Ferramenta remoção veio transmissão BMW 4x4

 Herramienta remocion eje transmision BMW 4x4

	BMW 4WD
OEM	1 315110 BMW

 **Características:**

Para remover o eixo de transmissão dianteiro
Torna a desmontagem muito mais fácil
Pega isolada por imersão

 **Características:**

Para desmontar el eje de transmisión delantero
Facilita el desmontaje
Mango aislado por inmersión

REF

3125



510gr



20x

 Ferramenta alinhar / centrar embraiagem sac 6pcs BMW

 Herramienta para alinear / centrar embrague sac 6pzs BMW

 **Descrição:**

Para centrar o disco de embraiagem no volante do motor enquanto instala a embraiagem autoajustável
Também pode ser utilizada para alinhar embraiagens novas e usadas
SAC pré-tensionadas
Medidas: 15mm x 23mm, 26,5mm, 28mm, 32,5mm e 34mm
Manga centralizadora: 15mm, 32,5mm

 **Descripción:**

Para centrar el disco de embrague en el volante mientras se instala el embrague autoajustable
También se puede utilizar para alinear embragues previamente tensados
Tallas: 15mm x 23mm, 26,5mm, 28mm, 32,5mm y 34mm
Casquillo de centrado: 15mm, 32,5mm



BMW

REF

3115



2kg



10x

 Jogo 14 chaves injetor e sonda lambda
 Juego 14 llaves inyector y sonda lambda



1x		1/2" x 20 mm, 6 pontas/puntas, ranhurado/ranurado, - 80mm: Universal
1x		1/2" x 27 mm, 6 pontas/puntas, ranhurado/ranurado - 78mm: Universal
1x		1/2" x 22 mm, 6 pontas/puntas, - 50mm, offset
1x		3/8" x 22 mm, 6 pontas/puntas, - 30mm, offset
1x		1/2" x 17 mm, 12 pontas/puntas, - 78mm: BMW, Mercedes-Benz, Renault
1x		1/2" x 19 mm, 12 pontas/puntas, - 78mm: VW, Audi, Seat
1x		1/2" x 21 mm, 12 pontas/puntas, - 85mm: Ford, VAG
1x		1/2" x 22 mm, 12 pontas/puntas, - 89mm
1x		1/2" x 22 mm, 12 pontas/puntas, - 110mm: Audi, BMW, Mercedes-Benz, VW, Volvo
1x		1/2" x 22 mm, 12 pontas/puntas, - 150mm: BMW
1x		1/2" x 27 mm, 12 pontas/puntas, - 78mm: BMW, Fiat, Ford, Peugeot
1x		1/2" x 27 mm, 12 pontas/puntas, - 110mm: PSA
1x		1/2" x 28 mm, 12 pontas/puntas, - 78mm: Volvo, Scania, HGV
1x		1/2" x 30 mm, 12 pontas/puntas, - 78mm: Bosch, General motors, Mercedes-Benz

Nota: Estas chaves não podem ser utilizadas com chaves de impacto

Nota: Estas llaves no pueden utilizarse con llaves de impacto



BMW, Mercedes-Benz, Renault, VW, Audi, Seat, Ford, VAG, Volvo

 **Descrição:**
Uma gama abrangente de chaves de caixa especializadas para aplicações automóveis, incluindo a instalação e remoção de sensores lambda e injetores diesel

 **Descripción:**
Una amplia gama de llaves de vaso especializadas para aplicaciones de automoción, incluida la instalación y extracción de sondas lambda e inyectores diésel

REF

6717



4kg



5x

 Jogo 3 chaves 14-17-19 abertas para injetores
 Juego llaves abiertas para inyectores 3pzs



1x		14mm: BMW, VW
1x		17mm: BMW, Opel 2.5TD, Mercedes
1x		19mm: Mercedes

REF

6825



14/17/19mm



500gr



20x

 Chave 1/2" injetor 10mm furada
 Llave 1/2" inyector 10mm inviolable



 **Aplicação:** Para desapertar o anel de retenção (anilha) dos injetores

 **Aplicación:** Para aflojar el anillo de retención (arandela) de los inyectores

REF	⊕	⊖	⚖	📦
8730	10mm		150gr	60x

 Chave 1/2" injetor hexagonal com janela 22mm
 Llave 1/2" inyector hexagonal con ventana 22mm



REF	⊕	⊖	⊖	⚖	📦
6122	22mm		105mm	281gr	60x

 Chave estriada para injetores Bosch
 Llave vaso inyectoros Bosch



Mercedes 601, 602, 603, 605, 606, 615, 616, 617

REF	⊕	⊖	⊖	⚖	📦
1583	20mm		56mm	90gr	50x

 Chave 1/2" bomba injetora bosh vp37 12.5MM
 Llave 1/2" bomba inyectora bosh vp37 12.5MM



 **NOTA:** Compatível com Jogo 5 chaves 1/2" para bombas injetoras Bosch, Ref: 2585

 **NOTA:** Compatible con el Juego 5 de llaves de 1/2" para bombas de inyección Bosch, Ref: 2585

REF	⚖	📦
6460	120gr	100x

 Chave de injetor estriada com janela
 Llave de inyector estriada con ventana



 Chave impacto xzn 1/2" inviolavel MT18
 Llave vaso impacto inviolable xzn 1/2" MT18



REF				
6827	27mm	80mm	250gr	20x
6828	28mm	80mm	193gr	48x

 Descrição: Chave especial para eixo traseiro Volkswagen, Golf e Seat Leon				
 Descripción: Llave especial para eje trasero Volkswagen, Golf y Seat Leon				
REF				
1445	45mm	90gr	150x	

 Jogo 5 chaves 1/2" para bombas injetoras Bosch
 Juego 5 llaves 1/2" para bombas inyectoras Bosch



1x		Para Bomba Injetora diesel Bosch VE (Bosch VE)	Chave triangular para encaixe do fecho central Llave triangular para la ranura de bloqueo central
1x			Chave para tampa regulador Llave para tapa regulador
1x		Para Bomba inyectora diesel Bosch VE (Bosch VE)	Chave triangular para parafusos que regulam a alavanca de rolamentos Llave triangular para la regulación de los cojinetes de palanca tornillos
1x		Para bomba injetora diesel Bosch VP EDC TDI (Bosch TDI): Chave triangular para o parafuso da tampa superior Para bomba injetora diesel Bosch VP EDC TDI (Bosch TDI): Llave triangular para el tornillo tapa superior	
1x		Para bomba injetora diesel Bosch VP 37 (Bosch CR): Chave triangular para o corpo Para bomba injetora diesel Bosch VP 37 (Bosch CR): Llave triangular para el cuerpo	

REF		
2585	700gr	20x

 Extrator carroto bomba diesel VAG
 Extractor de engranaje bomba diesel VAG



	VW Golf (13), Audi A3 (13), Škoda Rapid (12), Octavia (13), Fabia (14) Superb (15), Kodiaq (16), Seat Alhambra (11), Ibiza (08), Leon (13), Ateca
	T10489

 **Descrição:**
Especialmente projetado para remover a bomba de combustível de alta pressão em motores 1.4, 1.6, 2.0TDI
Aplicações: Parafuso de força hexagonal de 15mm e hexágono de retenção de 24mm

 **Descripción:**
Especialmente diseñado para quitar la bomba de combustible de alta presión en motores 1.4, 1.6, 2.0TDI
Aplicações: Tornillo de resistencia hexagonal de 15mm y hexágono de retención de 24mm

REF		
6454	530gr	20x

 Extrator bomba de injeção BMW N47/N57
 Extractor bomba de inyección BMW N47/N57



REF	⊕	📏	📦
6443	32mm	82gr	100x

 Extrator bomba de injeção diesel
 Extractor bomba de inyección diesel



Ford 2.2 TDCI, Transit 2.2 TDCI (2011-),
Land Rover 2.2 TD4 (01-15)

REF	📏	📦
6439	243gr	1x

 Extrator bomba injeção diesel BMW
 Extractor bomba inyección diesel BMW



M47, M47T2, M47TU, M57, M57TU



E46: 318D, 320D (98-05), E60, E61: 318TD,-
320TD, 525D, 530D, 530, 535 (00-06),
E38: 730D, E53: X5 3.0D



13.5.190 / 13.5.191 / 13.5.192

REF	⊕	📏	📦
6453	M30x1.5	525gr	20x

 Extrator bomba de injeção
 Extractor bomba inyectora



M47, M47T2, M47TU, M57, M57TU



E46: 318D, 320D (98-05), E60, E61: 318TD,-
320TD, 525D, 530D, 530, 535 (00-06), E38:
730D, E53: X5 3.0D



13.5.190 / 13.5.191 / 13.5.192

REF	⊕	📏	📦
6441	M40x1.5mm/M30x1.5mm	340gr	50x

 Extrator bomba de injeção
 Saca poleas bomba inyección



BMW 6 cili. 2.5D (M51), 2.5TDS (E34/ E36/ E38) Opel Omega 2.5TD, Land Rover

REF	⊕	⚖	📦
6440	M27x1.5	200gr	50x

 Extrator bomba injeção M28
 Saca poleas bomba inyección M28



 Ferramenta remoção transmissão embraiagem dupla
 Herramienta de extracción de transmisión de doble embrague



Volvo: C30, C70, S60, 580, S80L, V40, V40, V50, V60, V70, XC60
Ford: Focus, C-Max, Smax, Galaxy, Mondeo, Kuga
Dodge Avenger, Journey, Chrysler Sebring

REF	⊕	⚖	📦
6450	M28x1.5	200gr	50x

 **Descrição:**
Para permitir a remoção da caixa da embraiagem completa com os pratos da embraiagem da transmissão automática Getrag de 6 velocidades
Transmissão automática 6DCT450

 **Descripción:**
Para poder desmontar el cárter del embrague completo con los discos de embrague de la transmisión automática Getrag de 6 velocidades
Transmisión automática 6DCT450

REF

⚖

📦

3126

2kg

5x

 Kit extrair / montar bomba injeção Ford 2.0 ecoblue diesel
 Kit extraer / montaje bomba inyección Ford 2.0 ecoblue diesel



AWD, FWD, RWD (16), Focus, Galaxy, S Max (18) Ranger (2019-)



YLFS, YMFS, YNFS, YLF6, YMF6, YNF6, YLR6, YMR6, YMR6, YNR6, YLDA ,BCCC, YMCB, YNCA



Ford Transit, Transit Custom, Tourneo Custom 2.0, Ecoblue TDCi



303 1635

REF	⚖	📦
6455	1,62kg	5x

 Jogo cortantes para injetores 7 peças
 Set escariadores para inyectoros 7 piezas

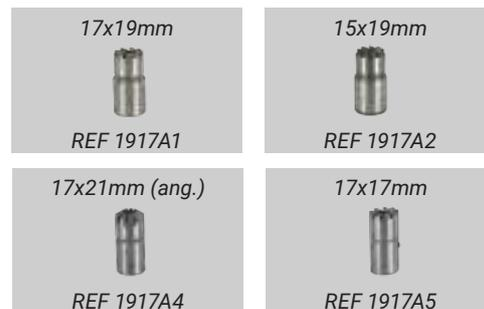

5x		17x19mm: Mercedes CRD 15x19mm: Universal, 17x21mm (ângulo/ángulo): Fiat/Iveco, 17x17mm (ângulo/ángulo): Mercedes CDI, 17x17mm: BMW, PSA, Renault, Ford
1x		T: 130x160mm, chave/llave 19mm
1x		19x175mm
1x		L: 2.5mm

REF

1917



1,6kg



5x

 Jogo cortantes para injetores 11 peças
 Set escariadores para inyectoros 11 piezas



7x		Plana: 15x19mm, plana 17x17mm, 17x19mm, 18x21mm, 20x21mm Angular: 17x17mm, 17x21mm
1x		T 135x160mm, chave/llave 19mm
1x		19x170mm
1x		15.5x225mm
1x		L: 2.5mm

REF

1920



1,8kg



5x

 Jogo fresas para limpeza de sensor ABS
 Set escariador para sensor abs



4x		4x32.5x42.6mm, 15x23x33.5mm, 18x23x31.5mm, 18x35x42.7mm
1x		Punho em T / Mango em T



VAG, Fiat, Škoda, Seat, BMW (E36/46), Mercedes classe A, Mazda, Toyota

REF

1925



2,14gr



1x

 Jogo completo cortantes para injetores
 Set completo de escariadores para injetores

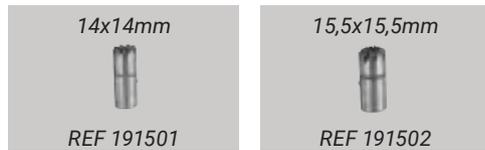

13x		Fresas: 14x14mm, 15.5x15.5mm, 17x17mm, 17x17.5mm, 17x19.5mm, 17x21mm (ângulo/ângulo), 19x21.5mm, 15x19mm, 15.5x15.5mm (ângulo/ângulo), 17x17mm (ângulo/ângulo), 17x19mm, 17x20mm 17.5x20.5mm (ângulo/ângulo)
6x		Conector M5x0.5
4x		Escovas de limpeza / Cepillos de limpeza
2x		19x170mm, 15,5x250mm
1x		Suporte de escovas / Soporte de cepillos
1x		T hex.: 19mm
1x		L: 2.5mm
1x		Extractor de vedantes / Extractor de sellos
1x		Guia para cortador / Guía para cortador
1x		Extensão para suporte de escova / Extensión para soporte de cepillo
1x		Barra de conector 200mmx5mm / Barra de conector 200mmx5mm
3x		Conector cónico Conector cónico

REF		
1915	5kg	2x

 Jogo cortantes para injetores 2.0 TDI
 Set escariadores para injetores 2.0 TDI



REF		
1918	2,14kg	1x

 Pata para extrator injetores cdi pancada
 Pieza juego extractor



REF		
8542P	520gr	25x

 Extrator injetores pancada grupo VAG
 Juego extractor inyectores VAG



	TDI
	ALH, AHU, 1ZAHU/1Z

REF		
8541	1,26kg	1x

-  Kit sacar injetores CDI
 Set extractor inyectores CDI



Mercedes Benz Sprinter 2.7, ML270, Classe E, Classe C, 108 CDi ,Vito 110 CDi 16v Vito 112 16V C200 CDi 16V C220 CDi 16v E200 CDi 16v, Chrysler Grand Cherokee 2.7crd (00-)

REF



8547

1,38kg

10x

-  Kit sacar injetores CDI motor 668
 Set extractor inyectores CDI motor 668



 **Aplicação:** Para extrair os injetores da cabeça do cilindro mesmo esta estando apertada
 Não necessita retirar a cabeça do cilindro do motor

 **Aplicación:** Para extraer los inyectores de la cabeza del cilindro incluso esta estando apertada
 No necessita quitar la cabeza del cilindro del motor

REF



8548

4,2kg

1x

-  Kit sacar injetores PSA
 Set extractor inyectores PSA

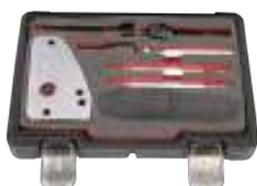

Parafuso / Tornillo



REF 8546P



PSA 2.0 110/135HP DW10

REF



8546

3,7kg

5x

-  Extrator injetor diesel JLR 2.7/3.6
 Extrator injetor diesel JLR 2.7/3.6



OEM

303-1127

 **Aplicação:** Ferramenta de remoção de injetor diesel, desenhada especificamente para extrair os injetores common rail usados em Jaguar e Land Rover. Motores: diesel TDi V6 e 3.6 TD

 **Aplicación:** Herramienta de extracción de inyectores diesel diseñada específicamente para extraer inyectores de common rail utilizados en Jaguar y Land Rover. Motores: diesel TDi V6 y 3.6 TD

REF



1633

200gr

50x

 Extrator injetor common rail VAG FSI/PD
 Extrator inyector common rail VAG FSI/PD



	1.4SDI / TDI, 1.9D / SF / TDI / TDI (PD), 2.0TDI / TDI (PD) - 2.8TDI (PD)
	VW, Audi, Seat, Škoda com injeção direta motores e alimentadores com unidade de bomba injetora/ con Inyección directa motores y alimentadores con unidad de bomba inyección
	T10133 + T10163

REF		
1628	3,6kg	4x

 Extrator injetores BMW
 Juego extractor inyectores BMW



	M47TU, M57, M57TU 2.7 diesel/ diésel (05-12)
---	--

REF		
8543	6,5kg	2x

 Ferramenta rem. / inst. injetores combustível BMW
 Herramienta rem. / inst. inyectores combustible BMW



	N20/N47/N54/N55/N57/N63
	BMW
	130 270, 130 320, 130 180

REF		
1627	2,5kg	2x

 Kit 8pcs para desapertar injetores
 Kit para destornillar inyectores 8pzs

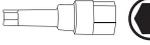
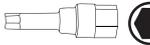

3x		Ferramentas lapidação esfera da válvula injetor Herramientas lapidación esfera de válvula inyector
1x		Ferramenta remoção da base injetores Denso CR Herramienta remoción da base inyectores Denso CR
1x		10mm, 6.6mm
1x		10mm, 7.6mm
1x		Chave octagonal para injetores Bosch
1x		Ferramenta remoção da parte interna dos injetores Siemens CR

REF		
8745	900gr	20x

-  Jogo sacar injetores grupo Kia/Hyundai
 Juego extractor inyectores grupo Kia/Hyundai



	Hyundai: Starex, Lavita, Matrix, Trajet, Terracan, Santa Fe (SM), Libero, Avante XD, Grandeur XG Getz, Tucson, NF Sonata Accent
---	---

-  Jogo extrator injetor Fiat/Opel/Ford/Suzuki
 Juego extractor inyector Fiat/Opel/Ford/Suzuki



	<p>Fiat: 500, Punto, Grande Punto, Panda, Idea, Doblo, Stilo, Bravo, Croma, Ducato - Multijet 1.3 16V / 1.6 16V / 1.9 16V / 2.0 16V</p> <p>Lancia: Ypsilon, Musa, Delta - Multijet: 1.3 16V / 1.6 16V / 1.9 16V</p> <p>Alfa Romeo: MiTO, 147, 159, Brera - 1.3/1.6/1.9/2.0 16V</p> <p>Opel: Corsa (C-D) Agila (B), Astra (H), Astra GTC, Meriva, Tigra (B), Combo Tour, Vetra (C), Insignia, Zafira (B) - 1.3/1.9/2.0 CDTI</p> <p>Suzuki: Ignis, Splash, Swift, Wagon R+, Sx4, Grand Vitara - 1.3/1.9 DDiS 16V</p> <p>Ford: Ka 09 - 1.3 Duratorq</p> <p>Iveco: Daily 3.0</p> <p>PSA: Boxer, Jumper - 3.0</p>
---	--

REF		
1554	8,3kg	1x

REF		
8554	15kg	1x

-  Kit hidráulico extrator de injetores diesel
 Kit hidráulico extractor de inyectores diesel



Bomba hidráulica manual con manómetro
REF 8457 (não incluída)

Bomba hidráulica manual con manómetro
REF 8457 (no incluída)



-  **Características:**
 Kit universal completo com cilindro hidráulico para remoção de injetores de combustível presos
 Cilindro hidráulico com 10T de força
 Máx. 7000 PSI
 Pode ser usado como um kit mecânico para espaços confinados
 Pode ser usado como um kit hidráulico em que com a potência máxima permitida ajuda a libertar os injetores presos
 Este jogo permite-lhe economizar tempo e dinheiro
 Os pés de apoio ajustáveis permitem o ajuste de ângulo e posição
 As barras laterais e superiores permitem vários ajustes do motor
- Aplicação:**
 Adequado para a extração de injetores de combustível diesel específicos: M17 x 1,0 para Bosch, M14 x 1,5 para Delphi, M16 x 1,0 para adaptador Toyota, M20 x 1,0 para Denso, M25 x 1,0 / M27 x 1,0 para Siemens

-  **Características:**
 Kit universal completo con cilindro hidráulico para retirar inyectores de combustible atascados
 Cilindro hidráulico con 10T de fuerza
 Máx. 7000 PSI
 Se puede utilizar como kit mecánico para espacios reducidos
 Se puede utilizar como kit hidráulico en el que con la máxima potencia permitida ayuda a liberar los inyectores atascados
 Este juego te permite ahorrar tiempo y dinero
 Los pies de apoyo ajustables permiten ajustar el ángulo y la posición
 Las barras laterales y superiores permiten varios ajustes del motor

- Aplicación:**
 Adequado para extraer inyectores de combustible diesel específicos: M17 x 1.0 para Bosch, M14 x 1.5 para Delphi, M16 x 1.0 para adaptador Toyota, M20 x 1.0 para Denso, M25 x 1.0 / M27 x 1.0 para Siemens

REF		
8450	15,5kg	1x

-  Kit hidráulico extrator injetores diesel 9 peças
-  Kit hidraulico extractor inyectoros diesel 9 piezas



Descrição:
Transforma todos os extratores de injetores diesel em kits hidráulicos de 17T
Este conjunto permite a extração controlada dos bicos dos injetores de encaixe muito apertados ou de injeção de impacto
É utilizado em conjunto com um extrator de bicos injetores com ponte de extração e uma bomba hidráulica

Conteúdo:
Cilindro hidráulico 17T (com Porca M16 x 1.5)
Anel espaçador
Fuso extrator M14 x 1.5 (240mm) rosca externa
Fuso extrator M14 x 1.5 (315mm) rosca externa
Fuso extrator M17 x 1.0 (240mm) rosca interna
Fuso extrator M17 x 1.0 (315mm) rosca interna
Fuso extrator M18 x 1.5 (250mm) rosca interna
Fuso extrator M25 x 1.0 (240mm) rosca interna

Descripción:
Todos los extractores de inyectoros diesel en kits hidráulicos de 17T
Este juego permite la extracción controlada de boquillas de ajuste muy apretado o boquillas de inyección de impacto
Se utiliza en combinación con un extractor de boquillas con un puente de extracción y una bomba hidráulica

Contenido:
Cilindro hidráulico 17T (con tuerca M16 x 1.5)
Anillo espaciador
Husillo extractor M14 x 1.5 (240mm) rosca exterior
Husillo extractor M14 x 1.5 (315mm) rosca exterior
Husillo extractor M17 x 1.0 (240mm) rosca interior
Husillo extractor M17 x 1.0 (315mm) rosca interior
Husillo extractor M18 x 1.5 (250mm) rosca interior
Husillo extractor M25 x 1.0 (240mm) rosca interior

REF

8460



6kg



1x

-  Jogo pneumático extrator injetor
-  Estuche neumatico extractor inyector



Aplicação: Ferramenta para extração dos bicos injetores presos

Compacto e eficaz - a solução para problemas em que um martelo deslizante não pode ser usado

Descrição:
Força de trabalho: 20-30Nm
Pressão de trabalho: 5-8 BAR (máx)

Composição:
(1x) Martelo pneumático
(20x) Adaptadores para várias aplicações

Aplicación: Herramienta para extraer boquillas de inyectoros

Compacto y eficaz: la solución para los problemas en los que no se puede utilizar un martillo deslizante

Descripción:
Fuerza de trabajo: 20-30Nm
Presión de trabajo: 5-8 BAR (máx)

Composición:
(1x) Martillo neumático
(20x) Adaptadores para diversas aplicaciones

REF

8470



7kg



2x

- Extrator injetor gasolina Ford
 Extrator inyector gasolina Ford



OEM

310-206

Aplicação: Extraí facilmente os injectores de gasolina sem danificar o injetor ou a cabeça. Para remover injectores Bosch GDI em todos os modelos Ford EcoBoost padrão motores a gasolina com capacidade 1.0-3.7L

Composição:

Martelo deslizante: 840gr, Ø 45mm
 Extrator rosca externa M10x1,5
 Gancho 13-20mm

Aplicación: Extrae fácilmente los inyectores de gasolina sin dañar el inyector ni el cabezal. Para desmontar los inyectores Bosch GDI en todos los Motores de gasolina estándar Ford EcoBoost con capacidad 1.0-3.7L

Composición:

Martillo deslizante: 840gr, Ø 45mm
 Extractor de rosca exterior M10x1,5
 Gancho 13-20mm

REF



8562

1,45kg

10x

- Kit 3 adaptadores saca injetor m14x1.5 - 16/13.5/12mm
 Kit 3pzs adaptadores extractor inyector m14x1.5 - 16/13.5/12MM

 **Características:**

M14x1.5 - 12MM
 M14x1.5 - 13.5MM
 M14x1.5 - 16MM

Características:

M14x1.5 - 12MM
 M14x1.5 - 13.5MM
 M14x1.5 - 16MM

REF



8471

700gr

20x

- Jogo extrator injetor Ford/Volvo gasolina
 Juego extraer inyectores Ford/Volvo gasolina



1.0L, 2.0L Duratec 1.0L, 1.5L, 1.6L, 2.0L, 2.3L, 2.7 L, 3.5L EcoBoost; 2.0L, 3.5L GTDI



Ford , Volvo



OEM 310-206 - Ford
 OEM 9997410 - Volvo

REF



8479

2,3kg

8x

- Jogo sacar injetores completo
 Juego extraer inyectores completo

 **Descrição:**

Inyectores Bosch, Denso, Siemens e Delphi

Composição:

(3x) Martelos deslizantes: 1.6kg 160mm, 2.7kg 460mm, 5.1kg 600mm
 (2x) Garras abertura tipo garfo: 13.7x18x105mm, 12.7x19x130mm
 (5x) Chaves de caixa com janela: 25,27,28,29,30mm x 100mm
 (1x) Extrator de injetores 35x29 M17x1.0
 (4x) Sacas com rosca interior: M27x1.0 [3x], M25x1.0 [1x]
 (3x) Sacas com rosca exterior: M27x1.0
 (1x) Martelo deslizante com adaptador de garra exterior

Descripción:

Inyectores Bosch, Denso, Siemens e Delphi

Composición:

(3x) Martillos deslizantes: 1.6kg 160mm, 2.7kg 460mm, 5.1kg 600mm
 (2x) Garras abertura tipo horquilla: 13.7x18x105mm, 12.7x19x130mm
 (5x) Llaves de vaso con ventana: 25,27,28,29,30mm x 100mm
 (1x) Extractor de inyectores: 35x29 M17x1.0
 (4x) Extractor con rosca interior: M27x1.0 [3x], M25x1.0 [1x]
 (3x) Extractor con rosca exterior: M27x1.0
 (1x) Martillo deslizante con adaptador para extractor garra externa

REF



8549

21kg

1x

 Jogo extrator injetor Ford 2.0 Ecoblue
 Juego extraer inyector Ford 2.0 Ecoblue



	Ford 2.0L EcoBlue
	Ford Edge, Focus, Galaxy, Ranger, S-Max, Tourneo, Transit (2016)
	303-1690, 303-1690/1, 303-1690/2

REF		
8449	1kg	10x

 Kit martelo deslizante com rosca - 10pcs adaptadores
 Juego de martillo deslizante de 10 piezas con adaptadores



 **Descrição:**
Extrator estável com martelo deslizante de formato ergonómico
Para a adaptação de ferramentas
Em combinação com o adaptador adequado ou extrator interno, a peça a ser extraída é removida por meio de golpes fortes com o martelo deslizante
Facilita a desmontagem de veios, rolamentos, engrenagens

 **Descripción:**
Extractor estable con martillo deslizante de diseño ergonómico
Para la adaptación de herramientas
En combinación con el adaptador adecuado o extractor interno, la pieza a extraer se retira mediante golpes fuertes con el martillo deslizante
Facilita el desmontaje de ejes, rodamientos y engranajes

REF		
8739	13kg	6x

 Extrator de injetores Land Rover/Jaguar
 Extractor de inyector Land Rover/Jaguar



	V8 5.0
	Jaguar, Land Rover.
	310-197

REF		
8553	2,1kg	1x

 Extrator anilhas injetor 370mm
 Extrator arandelas inyector 370mm



	BMW, Mercedes-Benz, PSA
---	-------------------------

 **Aplicação:** Para remover as anilhas do injetor com diâmetro interno de 4-16mm, também adequado para extração de anilhas de cobre que ficam presas no eixo do injetor
Ajuda a evitar danos na cabeça dos cilindros

 **Aplicación:** Para quitar las arandelas de los inyector con un diámetro interno de 4-16 mm, también aptas para extraer las arandelas de cobre que están pegadas en el eje del inyector
Ayuda a prevenir daños a la culata de cilindros

REF		
1914	1,4kg	10x

 Extrator de injetores diesel
 Extractor de inyectores diesel



	Land Rover 3.6lt TDV8, 2.7LT TDV6 - Land Rover Discovery 3, Discovery 4, New Range Rover, Range Rover Sport Jaguar X200 S-type, X250 XF. X350
	Jaguar, Land Rover.
	303-1127

REF

8550



2,9kg



1x

 Extrator anilha de cobre injetor
 Extractor insta. Arandelas cobre inyectores



Ponta / Punta



REF 1916P

 **Aplicação:** Aplicação universal para muitos modelos diesel common rail, entre eles BMW, Mercedes, entre outros
 Para remoção das anilhas de cobre difíceis de soltar
Buraco interno: 7mm

 **Aplicación:** Aplicación universal para muchos modelos diesel common rail, incluidos BMW, Mercedes y otros
 Para la remoción de las arandelas de cobre difíciles de soltar
Agujero interno: 7mm

REF

1916



230mm



600gr



10x

 Ferramenta instalar vedante injetor DV6 16V
 Instalador de retén de inyector DV6 16V



	diesel DV6 1.6 16V
	PSA DV6; Ford G8DX, HHDX, HHJX Mazda Y6; Suzuki 9HX; Volvo D164T
	Peugeot: 1007, 2008, 206, 207, 208, 3008, 301, 307, 308, 4008, 407, 5008, 508, Expert III, Partner I, Partner II, Partner III Citroën: Berlingo I / II / III, C2, C3 I / II, C4 I / II, C5 II / III, C-Elysee Dispatch, Jumpy III, Ds3, Ds4, DS5, Xsara Picasso. Fiat: Scudo Volvo: C30, S40, S80, V50, V70. Ford: C-Max, Fiesta, Focus, Focus C-Max, Fusion. Mazda: 2, 3, 5. Suzuki: SX4, SX4 Classic

REF

1910



475gr



40x

 Saca injetor com martelo deslizante BMW N43/53/54
 Extractor inyector martillo deslizante BMW N43/53/54



	1.6/2.0, 2.5/3.0
	BMW N43, N53/N54
	13 0180

REF

8740



750gr



20x

-  Kit extrair/installar injetores BMW/MINI B38/B48 gasolina
-  Kit extraer/montaje inyectores BMW/Mini B38/B48 gasolina



	B38/B48
	BMW, MINI
OEM	2 358 417, 2 358 022

REF		
8445	4kg	2x

-  Gancho G-shape com adaptador M20X1.5
-  Gancho G-shape con adaptador M20X1.5



-  **Descrição:**
Dimensões do gancho: 170x140x30mm
Rosca interna: M18x1.5, rosca externa: M20x1.5
-  **Descripción:**
Dimensiones del gancho: 170x140x30mm
Rosca interior: M18x1.5, rosca externa: M20x1.5

REF		
8558	2,4kg	10x

-  Sortido 85 peças conectores anti-fuga injetores
-  Estuche de conectores inyectores 85 piezas



-  **Conteúdo:**
(5x) Conector tipo T D7.0 (para tubo PA)
(10x) Conector tipo L D7.0 (para tubo PA)
(15x) Conector 102° D5.8 (para tubo PA)
(15x) Conector 90° D5.8 (para tubo de borracha)
(10x) Conector de compensação D5.8 (para tubo de borracha)
(10x) Conector tipo T D5.8 (para tubo de borracha)
(15x) Conector 90° D5.8 (para tubo de borracha)
(5x) Conector fecho de pressão Delphi D5.8 (para tubo PA)
-  **Contenido:**
(5x) Conector en T D7.0 (para tubo PA)
(10x) Conector tipo L D7.0 (para tubo PA)
(15x) Conector 102° D5.8 (para tubo PA)
(15x) Conector de 90° D5.8 (para tubo de goma)
(10x) Conector de compensación D5.8 (para tubo de goma)
(10x) Conector en T D5.8 (para tubo de goma)
(15x) Conector de 90° D5.8 (para tubo de goma)
(5x) Conector de cierre a presión Delphi D5.8 (para tubo PA)

REF		
4402	317gr	20x

 Kit limpeza assentos injetores diesel
 Kit limpieza asientos de inyectores diesel

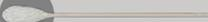

 Escov. / Escob. 8mm REF 4410-13		 Punho / Mango 1/4" REF 4410-14		 EW. Fléx. / EW Flex. 6" REF 4410-15		 Extensão / Extensión 6" REF 4410-16		 Zaragatoa / Torunda φ 7x200 mm REF 4410-19		 Zaragatoa / Torunda φ 5x200 mm REF 4410-20	
 Escov. / Escob. 0.500" REF 4410-07		 Escov. / Escob. 19mm REF 4410-08		 Escov. / Escob. 17mm REF 4410-09		 Escov. / Escob. 15mm REF 4410-10		 Escov. / Escob. 12mm REF 4410-11		 Escov. / Escob. 10mm REF 4410-12	
 Escov. / Escob. 1.375" REF 4410-01		 Escov. / Escob. 1.1875" REF 4410-02		 Escov. / Escob. 1.160" REF 4410-03		 Escov. / Escob. 0.990" REF 4410-04		 Escov. / Escob. 1" REF 4410-05		 Escov. / Escob. 0.750" REF 4410-06	
 Zaragatoa / Torunda φ 5x75mm REF 4410-17		 Zaragatoa / Torunda φ 16x200 mm REF 4410-18									

 **Descrição:**

Para a maioria das aplicações diesel, as escovas são especialmente concebidas para caber nos assentos dos injetores Remove ferrugem, carbono e outros detritos dos assentos e copos sem danos

Conteúdo:

(4x) Escovilhões helicoidal (1.375", 1.1875", 1.160" e 0.990") para limpeza profunda dos assentos
 (3x) Escovilhões 2-Stages (1", 0.750", e 0.500") para limpeza de assentos e furos interiores dos assentos
 (6x) Escovilhões (8mm, 10mm, 12mm, 15mm, 17mm, e 19mm) para a limpeza de furos e paredes de tubos
 (1x) Extensão flexível com engate rápido - 6"
 (1x) Extensão rígida com engate rápido - 6"
 (1x) Punho quadra 1/4" c/ engate rápido
 (4x) Zaragatoas φ 5x75mm, φ 16x200mm, φ 7x200mm, φ 5x200mm

 **Descripción:**

Para la mayoría de las aplicaciones diesel, las escobillas están especialmente diseñadas para ajustarse a los asientos de los inyectores

Elimina el óxido, carbono y otros restos de los asientos y vasos sin dañarlos

Contenido:

(4x) Escobillas helicoidales (1,375", 1,1875", 1,160" y 0,990") para la limpieza profunda de los asientos
 (3x) Escobillas 2-Stages (1", 0,750" y 0,500") para limpiar los asientos y los agujeros interiores de los mismos
 (6x) Escobillas (8 mm, 10 mm, 12 mm, 15 mm, 17 mm y 19 mm) para limpiar los agujeros y las paredes de los tubos
 (1x) Extensión flexible con acoplamiento rápido - 6"
 (1x) Extensión rígida con acoplamiento rápido - 6"
 (1x) Mango cuadrado 1/4" c/macho
 (4x) Torundas φ 5x75mm, φ 16x200mm, φ 7x200mm, φ 5x200mm

REF

4410



1,9kg



10x

 Sortido de anilhas de cobre injetores 551 peças
 Surtido de arandelas de cobre injectores 551 piezas

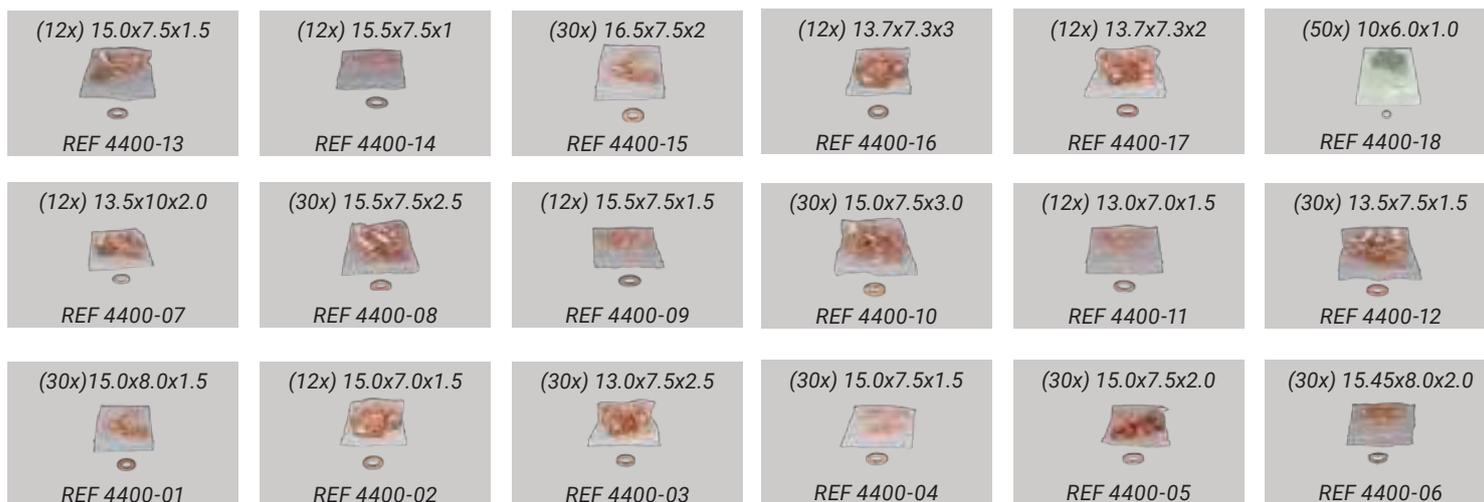

 **Composição:**

- (25x) Molas
- (30x) Bicos injetores plástico tipo L
- (30x) Anilhas alumínio 8x5.8x11
- (20x) Bicos injetores plástico tipo T
- (30x) Anilhas latão 15.8x7.5x3.0
- (50x) Anilhas aço 10x6.0x1.0
- (12x) Anilhas injetor cobre: KIA 13.7x7.3x2
- (12x) Anilhas injetor cobre: KIA 13.7x7.3x3
- (30x) Anilhas injetor cobre: Mercedes 16.5x7.5x2
- (12x) Anilhas injetor cobre: Land Rover 15.5x7.5x1
- (12x) Anilhas injetor cobre: Fiat 15.0x7.5x1.5
- (30x) Anilhas injetor cobre: Ford 13.5x7.5x1.5
- (12x) Anilhas injetor cobre: Deutz 13.0x7.0x1.5
- (30x) Anilhas injetor cobre: Renault 15.0x7.5x3.0
- (12x) Anilhas injetor cobre: Land Rover 15.5x7.5x1.5
- (30x) Anilhas injetor cobre: Ford 15.5x7.5x2.5
- (12x) Anilhas injetor cobre: Mazda 13.5x10x2.0
- (30x) Anilhas injetor cobre: Universal 15.45x8.0x2.0
- (30x) Anilhas injetor cobre: Iveco/Ford 15.0x7.5x2.0
- (30x) Anilhas injetor cobre: Iveco/Ford 15.0x7.5x1.5
- (30x) Anilhas injetor cobre: Renault 13.0x7.5x2.5
- (12x) Anilhas injetor cobre: Mercedes 15.0x7.0x1.5
- (30x) Anilhas injetor cobre: Universal 15.0x8.0x1.5

 **Composición:**

- (25x) Muelles
- (30x) Boquillas inyectoras plástico tipo L
- (30x) Arandelas aluminio 8x5.8x11
- (20x) Boquillas inyectoras plástico tipo T
- (30x) Arandelas latón 15.8x7.5x3.0
- (50x) Arandelas acero 10x6.0x1.0
- (12x) Arandelas inyector cobre: KIA 13.7x7.3x2
- (12x) Arandelas inyector cobre: KIA 13.7x7.3x3
- (30x) Arandelas inyector cobre: Mercedes 16.5x7.5x2
- (12x) Arandelas inyector cobre: Land Rover 15.5x7.5x1
- (12x) Arandelas inyector cobre: Fiat 15.0x7.5x1.5
- (30x) Arandelas inyector cobre: Ford 13.5x7.5x1.5
- (12x) Arandelas inyector cobre: Deutz 13.0x7.0x1.5
- (30x) Arandelas inyector: Renault 15.0x7.5x3.0
- (12x) Arandelas inyector cobre: Land Rover 15.5x7.5x1.5
- (30x) Arandelas inyector cobre: Ford 15.5x7.5x2.5
- (12x) Arandelas inyector cobre: Mazda 13.5x10x2.0
- (30x) Arandelas inyector cobre: Universal 15.45x8.0x2.0
- (30x) Arandelas inyector cobre: Iveco/Ford 15.0x7.5x2.0
- (30x) Arandelas inyector cobre: Iveco/Ford 15.0x7.5x1.5
- (30x) Arandelas inyector cobre: Renault 13.0x7.5x2.5
- (12x) Arandelas inyector cobre: Mercedes 15.0x7.0x1.5
- (30x) Arandelas inyector cobre: Universal 15.0x8.0x1.5

REF
4400

1,88kg

10x

 Kit escariador e extrator de velas incandescentes
 Juego escariador y extrator de calentadores

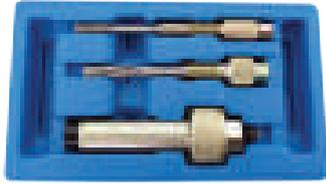

1x		M10x1.00 - motores 4, 5 e 6 cilindros, OM611,612,613, Smart CDI R660 M12x1.25 (motores de 4 válvulas OM604,605,606)
1x		M10x1.00 (motores 4, 5 y 6 cilindros, OM611,612,613, Smart CDI R660) M10x1.00 (motores 4, 5 y 6 cilindros, OM611,612,613, Smart CDI R660)
1x		Extractor de velas incandescentes para fios de rosca de velas SW10 Extractor calentadores para hilos de alentador SW10

REF

4443



578gr



1x

 Kit escariador velas incandescentes 7 peças
 Kit escariador de calentadores 7 piezas



 **Aplicação:** Para limpar e aparar a rosca das velas incandescentes na cabeça do motor
Também adequado para cabeças do motor com velas incandescentes profundas

Medidas: M8 x 1,0 x 115mm, M10 x 1,0 x 115mm, M12 x 1,25 x 140mm, M12 x 1,25 x 270mm, M14 x 1,25 x 140mm, M14 x 1,25 x 270mm, M18 x 1,5 x 90mm

 **Aplicación:** Para limpiar y recortar las roscas de las bujías en la culata
También es adecuado para las culatas con calentadores profundos

Medidas: M8 x 1,0 x 115mm, M10 x 1,0 x 115mm, M12 x 1,25 x 140mm, M12 x 1,25 x 270mm, M14 x 1,25 x 140mm, M14 x 1,25 x 270mm, M18 x 1,5 x 90mm

REF

4447



1,42kg



10x

 Kit sacar de velas incandescentes
 Juego extractor calentadores



Broca 2.5x120mm

REF 4450-1

Broca 3.3x140mm

REF 4450-2

Macho M3x0.5

REF 4450-3

Macho M4x0.7

REF 4450-4

2x		M3x0.5, M4x0.7
2x		2.5x120mm, 3.3x140mm
2x		M4x0.7 100mm, M3x0.5 100mm
3x		
9x		
3x		M10x1.25, M10x1.0, M8x1.0

REF

4450



1,35kg



5x

 **Kit escariador e extrator de velas incandescentes**
 **Juego escariador y extractor de calentadores**



 **Kit escariador e extrator velas incandescentes**
 **Juego escariador y extractor de calentadores**



- Composição:**
- (1x) Macho 1/4"x28 UNF
 - (1x) Macho 12x28 UNF
 - (1x) Macho M8x1.0
 - (1x) Macho M10x1.0
 - (1x) Macho longo M8x1.0
 - (2x) Brocas helicoidal 3.4mm
 - (1x) Broca helicoidal 4.4mm
 - (1x) Broca helicoidal 2.6mm
 - (1x) Broca passo 4.4x7mm
 - (1x) Broca passo 5.4x7mm
 - (1x) Broca passo 5.5x9mm
 - (2x) Parafusos tensor
 - (2x) Fusos
 - (2x) Mandris perfuração 2.6mm
 - (2x) Mandris perfuração 3.7mm
 - (1x) Chave hex. 3mm
 - (1x) Chave hex. 2mm
 - (1x) Chave hex. 2.5mm
 - (1x) Escova red. de aço 5x300mm
 - (1x) Escova red. de aço 7x300mm
 - (1x) Suporte de machos
 - (1x) Dispositivo de centralização
 - (1x) Porta brocas
 - (1x) Manga centragem
 - (1x) Suporte machos
 - (1x) Manga remoção
 - (1x) Porta brocas
 - (1x) Porca fuso
 - (1x) Chave 2.6mm
 - (1x) Chave 3.2mm
 - (1x) Chave 3.5mm
 - (1x) Chave 4.5mm
 - (1x) Chave 6.5mm
 - (1x) Chave 8.25mm
 - (1x) Chave E10

- Composición:**
- (1x) Macho 1/4"x28 UN
 - (1x) Macho 12x28 UNF
 - (1x) Macho M8x1.0
 - (1x) Macho M10x1.0
 - (1x) Macho largo M8x1.0
 - (2x) Taladros helicoidales 3.4mm
 - (1x) Taladro helicoidal 4.4mm
 - (1x) Taladro helicoidal 2.6mm
 - (1x) Taladro passo 4.4x7mm
 - (1x) Taladro passo 5.4x7mm
 - (1x) Taladro passo 5.5x9mm
 - (2x) Tornillos tensor
 - (2x) Husos
 - (2x) Mandriles perforación 2.6mm
 - (2x) Mandriles perforación 3.7mm
 - (1x) Llave hex. 3mm
 - (1x) Llave hex. 2mm
 - (1x) Llave hex. 2.5mm
 - (1x) Cepillo red. acero 5x300mm
 - (1x) Cepillo red. acero 7x300mm
 - (1x) Soporte de machos
 - (1x) Dispositivo de centralización
 - (1x) Puerta taladros
 - (1x) Manga de centrado
 - (1x) Soporte de machos
 - (1x) Manga de remoción
 - (1x) Puerta taladros
 - (1x) Tuerca huso
 - (1x) Llave 2.6mm
 - (1x) Llave 3.2mm
 - (1x) Llave 3.5mm
 - (1x) Llave 4.5mm
 - (1x) Llave 6.5mm
 - (1x) Llave 8.25mm
 - (1x) Llave E10

Perno 4mm



REF 4445P9

Macho M10



REF 4445M10X1

Macho M8



REF 4445M8X1

Macho 1/4"



REF 4445-14

Broca 7mm



REF 4445BR7

Broca 9mm



REF 4445BR9

Carraca / Roquete machos



REF 4445D

Descrição: Conjunto de ferramentas utilizado para desmontagem de velas de incandescência e reparação profissional. É adequado para velas de incandescência M8 e M10

Composição:

- (2x) Mandris adaptador do extractor
- (2x) Brocas piloto 3,5mm
- (1x) Macho M8
- (1x) Macho M10
- (1x) Macho 1/4"
- (1x) Roquete em T
- (1x) Broca escalonada 7mm
- (1x) Broca escalonada 8mm
- (1x) Chave em L umbrako
- (1x) Chave torx E10
- (2x) Casquilhos para brocas piloto 3,5mm
- (1x) Invólucro exterior do extractor
- (1x) Suporte de broca

Descripción: Conjunto de herramientas utilizadas para el desmontaje de bujías incandescentes y reparación profesional. Es adecuado para bujías incandescentes M8 y M10

Composición:

- (2x) Mandris adaptador do extractor
- (2x) Taladro piloto 3,5mm
- (1x) Taladro M8
- (1x) Taladro M10
- (1x) Taladro 1/4"
- (1x) Carraca em T
- (1x) Taladro escalonado 7mm
- (1x) Taladro escalonado 8mm
- (1x) Llave en L umbrako
- (1x) Llave torx E10
- (2x) Cojinetes para taladros piloto 3,5mm
- (1x) Invólucro exterior do extractor
- (1x) Soporte de taladros

REF

4446



3kg



5x

REF

4445



2,08kg



5x

-  Kit limpeza assentos injetores universal
 Kit limpieza de asiento inyector universal



Escova / Cepillo

REF 4405-01

Escova / Cepillo 24mm



REF 4405-02

Escova / Cepillo 20mm



REF 4405-03

Escova / Cepillo 18mm



REF 4405-04

Mandril flex.



REF 4405-05

Escova / Cepillo
19.5x15.5mm

REF 4405-08

Escova / Cepillo
17.5x20.5mm

REF 4405-09

-  **Aplicação:** Para limpar assentos dos injetores diesel antes de instalar os novos

Composição:

- (1x) Escova para porta do bocal do injetor 303mm
- (1x) Escova para porta principal do injetor 24mm
- (1x) Escova para porta principal do injetor 20mm
- (1x) Escova para porta principal do injetor 18mm
- (1x) Extensão flexível do mandril 224mm rápido
- (1x) Haste de inserção para bujões
- (6x) Bujões vedação porta do bocal injetor
- (1x) Escova área assento do injetor 19.5x15.5mm
- (1x) Escova área assento do injetor 17.5x20.5mm

-  **Aplicación:** Para limpiar los asientos del inyector diesel antes de la instalación de nuevos inyector

Composición:

- (1x) Cepillo puerta boquilla del inyector 303mm
- (1x) Cepillo puerta boquilla del inyector 24mm
- (1x) Cepillo puerta boquilla del inyector 20mm
- (1x) Cepillo puerta boquilla del inyector 18mm
- (1x) Extensión flexible del mandril 224mm rápido
- (1x) Vástago de inserción para tapones
- (6x) Tapón sellado puerta de la boquilla inyector
- (1x) Cepillo zona asiento del inyector 19.5x15.5mm
- (1x) Cepillo zona asiento del inyector 17.5x20.5mm

REF

4405



980gr



5x

-  Jogo 3 chaves para velas incandescentes
 Juego llaves bujias 3pzs



Alfa Romeo 147, 156, 159, GT, Spider, Brera;
Fiat Bravo, Stilo; Opel Astra, Signum, Vectra
C, Zafira; Saab 93/95

REF

2006



8/9/10mm



400gr



1x

-  Chave longa 12mm desapertar velas com proteção
 Llave larga destornillar bujias con protección



Opel: Corsa, Astra J, Insignia, Meriva, Zafira
D
VAG: Volkswagen, Škoda, Audi, Seat, etc

-  **Características:** Chave de 12mm x 1/4" e 5 tampas de proteção antiestáticas de plástico

-  **Características:** Llave de 12mm x 1/4" y 5 tapones tapas de protección antiestática de plástico

REF

2004



50/22mm



300gr



1x

-  Kit chaves longas 3/8" 10/12mm velas incandescentes
 Kit llaves largas 3/8" 10 y 12mm



-  **Características:**
Tamanhos das chaves: 10, 12mm
Hex 3/8" (6pt) x 120mm de comprimento

-  **Características:**
Medidas das llaves: 10, 12mm
Hex 3/8" (6pt) x 120mm de longitud

REF

2005



120mm



300gr



1x

 Jogo 6 chaves para velas incandescentes
 Juego 6 llaves para calentadores

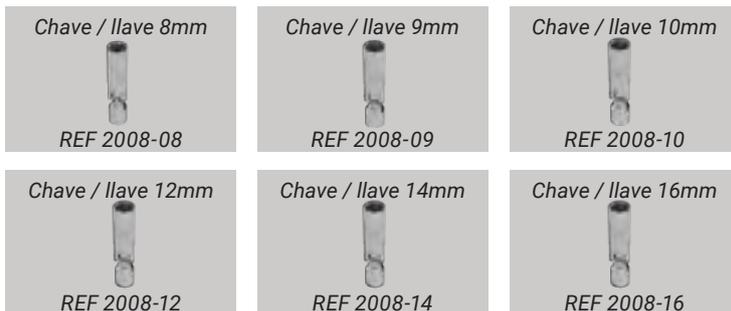

  **Medidas:** 8, 9, 10, 12, 14, 16mm

REF		
2008	540gr	1x

 Jogo 11 peças velas diesel/gasolina/lambda
 Juego para bujias 11 piezas



 **Composição:**
(2x) Aumentos 3/8": 75 e 250mm
(4x) Chaves velas 3/8": 14,16,16 (parede fina), 21mm
(3x) Chaves velas articuladas 3/8": 8,10,12mm
(1x) Chave sonda lambda 3/8" 22mm
(1x) Cardan articulado

 **Composición:**
(2x) Alargaderas 3/8": 75 y 250mm
(4x) Llave calentadores 3/8": 14,16,16 (pared delgada), 21mm
(3x) Llaves calentadores articuladas 3/8": 8, 10, 12mm
(1x) Llave sonda lambda 3/8" 22mm
(1x) Cardan articulado

REF		
2009	1,76kg	10x

 Chave sonda lambda 3/8" 22mm rasgada
 Llave sonda lambda 3/8" 22mm rasada



REF			
1595	78mm	270gr	50x

 Chave extra comprida xzn 
 Llave extra larga xzn



REF				
1590	M8	800mm	585gr	20x
1591	M10	800mm	575gr	1x
1593	M12	800mm	585gr	1x
1594	M14	800mm	1kg	1x

-  Chave 2pcs sonda lambda 1/2"-3/8" 22mm
 Llave lambda 2pcs 1/2"-3/8" 22mm



REF		
1596	420gr	48x

-  Chave lambda 1/2" 22mm aberta
 Llave sonda lambda 1/2" 22mm



REF		
1598	200gr	80x

-  Chave 1/2" xzn M17 rótula traseira VW
 Llave 1/2" xzn M17 rótula trasera VW 



REF			
12117	60mm	100gr	100x

-  Chave impacto xzn 1/2" inviolável m18
 Llave vaso impacto xzn 1/2" 



REF			
1450	45mm	289gr	100x

-  Jogo chaves impacto 1/2" extra finas xzn 2pcs
 Juego llaves impacto extra delgada 1/2" xzn 2pzs 



 **Descrição:** Para desapertar a união roscada do rolamento da roda na caixa de alumínio com o veio de transmissão instalado.

Características:

Quadrado: 1/2"
 Tamanho: M12 x 72mm de comprimento,
 M12 x 115mm de comprimento

 **Descripción:** Para desatornillar la conexión roscada del cojinete de la rueda en la carcasa de aluminio con el eje de transmisión instalado

Características:

Cuadrado: 1/2"
 Tamaño: M12 x 72mm largo, M12 x 115mm largo

REF		
6140	225gr	48x

Chave de caixa 1/2" bihexagonal 36mm
Llave de vaso 1/2" bihexagonal 36mm



Transmissões / Transmisiones: Alfa Romeo, Citroën, Fiat, Lancia, VW

REF		
1585	642gr	24x

Chave de caixa 3/4" hexagonal 65mm Ford Transit
Llave de vaso 3/4" hexagonal 65mm Ford Transit



Aplicação: Eixo traseiro da roda Ford Transit

Aplicaciones: Eje trasero de la rueda Ford Transit

REF		
1586	300gr	1x

Chave de caixa 1/2" bihexagonal 46mm
Llave de vaso 1/2" bihexagonal 46mm



Renault Master

REF		
1580	200gr	20x

Chave 3/4" bi-hexagonal 56mm e 65mm
Llave vaso 3/4" bihex. 56mm y 65 mm



Aplicação: Eixo traseiro da roda Ford Transit

Aplicaciones: Eje trasero de la rueda Ford Transit

REF			
1589	56mm	1,1kg	1x
1584	65mm	1,2kg	10x

Chave porca eixo camiã 1" (octagonal)
Llave tuerca eje camión 1" (octagonal)



REF			
20085	85mm	2,45kg	4x
20095	95mm	2,62kg	4x
20115	115mm	4,25kg	4x
20120	120mm	4,2kg	4x
20130	130mm	5,35kg	4x

Chave 1/2" 18mm ajuste curvatura VAG
Llave 1/2" 18mm ajuste inclinación VAG



REF		
6136	180gr	50x

Chave especial 1/4" para ajustar válvulas VAG
Llave especial 1/4" para ajustar válvulas VAG



REF		
2580	169gr	1x

Chave especial turbo Audi diesel
 Llave especial turbo Audi diesel



REF	⊕	⚖	📦
6135	12mm	125gr	48x

Chave especial 21mm caixa Audi
 Llave especial 21mm caja Audi



	Audi Q7 (07-11), VW Touareg (03-14), Porsche Cayenne
OEM	T10188

REF	⊕	⚖	📦
6130	21mm	150gr	1x

Kit 2 chaves estrela para montar/desmontar suportes motor Mercedes
 Kit 2 llaves estrella para montar/desarmar soportes motor Mercedes



	W220, W210, W203, W221, W211, W204, W124, W140, W170, W126, W201, W202, W210
--	--

2x		10mm (3/8") 12P, 16mm 10mm (3/8") 12P, 17mm
----	--	--

REF	⚖	📦
6470	300gr	50x

Chave caixa 1/2" impacto T-100x78mm Mercedes
 Llave vaso impacto 1/2" Torx T100x78mm



	Mercedes M133/M157/M270/M271/M276/M278
--	--

Aplicação: Especialmente concebida para corrigir a posição da polia da árvore de cames

Aplicación: Especialmente diseñada para corregir la posición de la polea árbol de levas

REF	⊕	⊥	⚖	📦
125100	T100H	78mm	183gr	80x

Chave pre camera Mercedes
 Llave pre camera Mercedes



	Mercedes 601, 602, 603, 605, 606, 661, 662
--	--

Características: Quadra 1/2", 58 dentes, Altura: 60mm

Características: Cuadrado 1/2", 58 dientes, Altura: 60mm

REF	⊕	⊥	⚖	📦
6125	58D	60mm	220gr	100x

Chave porca eixo traseiro Mercedes Sprinter W901-W905
 Llave tuerca eje trasero Mercedes Sprinter W901-W905



	741.407, 741.408, 741.409
--	---------------------------

	Eixo traseiro Mercedes Sprinter (W901-W905) Eje trasero Mercedes Sprinter (W901-W905)
--	--

OEM	1 3440 Volkswagen
-----	-------------------

Especificações:
 Diâmetro interior: 65.6mm
 Aba - aba: 57.44mm
 Abas: 7.54mm de largura

Especificaciones:
 Diámetro interior: 65,6 mm
 Solapa - solapa: 57,44 mm
 Solapas: 7,54 mm de ancho

REF	⚖	📦
3123	404gr	48x

 Kit chaves longas 3/8" 8-14mm 6 peças
 Kit llaves largas 3/8" 8-14mm 6 piezas



		VAG, Opel, BMW, Ford
5x		3/8": 8,10,12,13,14mm. Comprimento/ Longitud:120mm
1x		1/4"F x 3/8"

REF		
2007	625gr	20x

 Kit chaves especiais 1/2" 10 peças
 Kit llaves especiales 1/2" 10 piezas



1x		10S (6PT) - Toyota
3x		6S, 8S, 12S (6PT) - Nissan, Renault
1x		8TS (3PT) - Nissan
2x		10mm, 12,5mm - 5 lados (pentagonal) - Nissan
1x		14mm, 5 lados (pentagonal) - Astra G, Zafira, Smart
1x		19mm - 5 lados (pentagonal) - Citroën, Peugeot, Renault
1x		20mm - 10 pontos/puntos - Honda Civic

REF		
6090	950gr	20x

 Kit chaves especiais 1/2" para colaça 3 peças
 Kit llaves especiales 1/2" punta culata 3 piezas



3x		10,12,14mm - Toyota, Nissan, Honda
----	--	------------------------------------

REF			
6091	120mm	640gr	20x

 Chave fixar polia bomba alta pressão Opel/Renault/Nissan
 Llave sutener polea bomba alta pression Opel/Renault/Nissa



	Diesel
	F9Q
	Opel, Renault, Nissan

REF		
6123	437gr	8x

 Extrator de polias universal
 Extractor de poleas universal



 Descrição: Fuso com diâmetro 16mm e porcas hexagonais 24mm

 Descripción: Husillo con diámetro 16mm y tuercas hex. 24mm

REF		
7165	800gr	10x

-  Sacar polias motor com braços reguláveis
 Extractor poleas motor con brazos regulables



 **Descrição:** Diâmetro geral 42-82mm
 Altura braço: 28.8mm

 **Descripción:** Diámetro general 42-82mm
 Altura brazo: 28.8mm

REF



7160

400gr

10x

-  Sacar polias ribe
 Extractor polias ribe



 **Descrição:**
 Desenhado especialmente para ser usado em qualquer polia ribe
 Pode ser usada também em cambotas, alternadores, unidades de ar
 e bombas de água
 Medida interior de abertura máxima 160mm

 **Descripción:**
 Diseñado especialmente para ser usado en cualquier polea ribe
 Se puede utilizar también en cigueñales, alternadores, unidades de
 aire y bombas de agua
 Medida interior de la apertura máxima 160mm

REF



8540

80mm

200mm

1,5kg

10x

-  Kit montagem embraiagem/volante do motor
 Kit de montaje de embrague/volante



3x		Conjunto de gancho com dispositivo de fixação Conjunto de gancho con dispositivo de sujeción
1x		Estrela de fixação dupla / Estrella de sujeción doble
2x		M10 x 1,25mm
2x		Manga de pressão para instalação Manguito de presión para instalación
2x		Manga de suporte para remoção Manguito de soporte para extracción



Renault

REF



3117

4,5kg

2x

-  Extrator polia bomba de injeção VW 2.0 TDI
 Extractor polea bomba de inyección VW 2.0 TDI



6 cilindros common rail 2.0 TDI,
 4 cilindros common rail 1.6 TDI

REF



8640

1,34kg

1x

-  Jogo extrator para polia ar condicionado
 Juego extractor para polea aire acondicionado



 **Aplicação:** Para trocar a polia da embraiagem nos compressores de ar condicionado, GM R4/R6, HR6, DA-6 e V5, compressores sanden SD505/507/510/575/708/709 etc

 **Aplicación:** Para cambiar a polea del embrague en los compressores de aire acondicionado, GM R4/R6, HR6, DA-6 e V5, compressores sanden SD505/507/510/575/708/709 etc

REF



8107

1,9kg

5x

 Jogo de extrator pernos 25 peças
 Juego para extracción de pernos 25 piezas



<p>Broca 1/8"</p>  <p>REF 0512-10</p>	<p>Casquilho</p>  <p>REF 0512-8</p>	<p>Extrator</p>  <p>REF 0512-7</p>
<p>Macho 1/4"</p>  <p>REF 0512-5</p>	<p>Macho 3/16"</p>  <p>REF 0512-3</p>	<p>Macho 1/8"</p>  <p>REF 0512-2</p>

 **Composição:**
(10x) Buchas guia para brocas
(5x) Pinos extractores
(5x) Adaptadores de extrator
(5x) Brocas HSS: 1/8", 3/16", 1/4", 5/16" 11/32"

 **Composición:**
(10x) Casquillos guía de taladro
(5x) Pasadores extractores
(5x) Adaptadores para extractores
(5x) Taladros HSS: 1/8", 3/16", 1/4", 5/16" 11/32"

REF		
0512	700gr	20x

 Kit extrator de machos M4-M22 9 peças
 Kit extractor de machos M4-M22 9 piezas



9x		#2 M5, #3 M6, #4 M8, #5 M10, #6 M12, #7 M14, #8 M16, #9 M18-M20, #10 M22
----	--	--

 **Aplicação:** Extrator com desenho para machos de 3 e 4 ranhuras

 **Aplicación:** Extractor con diseño para machos de 3 y 4 ranuras

REF		
0517	525gr	20x

 Jogo extrator de parafusos 11 peças
 Juego extractor de tornillos 11 piezas



 **Medidas:** 9,10,11,12,13,14,15,16,17,19mm
Usar com um roquete 3/8"

 **Medidas:** 9,10,11,12,13,14,15,16,17,19mm
Usar con una carraca 3/8"

REF		
0515	366gr	30x

 Jogo extrator e aplicador de pernos 9 peças
 Juego extractor y aplicador de espárragos 9 piezas



 **Medidas:** M6x1.0, M8x1.25, M10x1.25, M10x1.5

 **Medidas:** M6x1.0, M8x1.25, M10x1.25, M10x1.5

REF		
0516	670gr	1x

 Compressor de molas Macpherson 100-265mm 2300kg
 Compressor de muelles Macpherson 100-265mm 2300kg



 **Características:**
Ferramenta profissional para tensionar as suspensões Macpherson
Compressor de molas profissional para a oficina de automóveis
Área de trabalho de 300mm para diâmetros de mola entre 100-265mm
Ideal para mudar os amortecedores e comprimir as molas (suspensão desportiva)

 **Características:**
Herramienta profesional para tensar suspensiones Macpherson
Compressor de muelles profesional para el taller
Área de trabajo de 300mm para diámetros de muelle entre 100-265mm
Ideal para cambiar amortiguadores y comprimir los muelles (suspensión deportiva)

REF		
1944	15,5kg	1x

Compressor molas amortecedor
 Compressor muelles amortiguador



Chrysler, Chevrolet, Citroën, Ford, Honda, Hyundai, Kia Mazda, Mitsubishi, Peugeot, Renault, Škoda, Suzuki, Toyota, Volvo, VW. Incluindo: BMW série 3 (96-13) Mercedes Benz W202 / W204 (97-13)

Descrição:
 Para sistemas de suspensão wishbone, independentes e multi-link Adequado para molas onde o orifício inferior de acesso a suspensão desejado é 30mm ou maior (tamanho do eixo da ferramenta 29mm) Carga máxima 3800kgf (37,240N)

Descripción:
 Para sistemas de suspensión wishbone, independentes y de enlace múltiple. Adequado para muelles donde el el orificio inferior de acceso a la suspensión deseado es de 30mm o mayor (tamaño del husillo de la herramienta 29mm). Carga máxima 3800kgf (37,240N)

REF

2637



6,5kg



2x

Compressor de molas suspensão Macpherson
 Compressor de muelles suspensión Macpherson



BMW, Toyota, Ford, Mitsubishi, VW, Audi, Saab, Nissan, Honda, Subaru, Volvo, Opel, Porsche

2x		80-115mm - 1,45kg
2x		110-150mm - 2,2kg
2x		140-195mm - 2,3kg
1x		453mm - 5,17kg

REF

1941



1000kg



14kg



1x

Compressor de molas Macpherson hidráulico
 Compressor de muelles Macpherson hidráulico



Características:
 Curso máximo: 420mm
 Diâmetro molas: 102-165mm
 Acionamento por pedal
 Pressão máxima de ar: 0.9Mpa

Características:
 Curso máximo: 420mm
 Diámetro muelles: 102-165mm
 Acionamento por pedal
 Presión máxima de aire: 0.9Mpa

REF

1950



1000kg



70,7kg



1x

 Compressor de molas
 Compressor de muelles



REF	↔	📏	📦
6324	370mm	2kg	10x

 Jogo chaves para fêmeas suspensão
 Juego llaves para tuercas almenadas suspensión



	10.5x3.5mm: VW Golf, 12.5x3.5mm: VW Polo, 14x2.5mm: Mercedes (W203), 14.5x3mm: VW Polo, Golf, Audi 80/90, 14.5x5mm: Austin Maestro
---	--

REF	📏	📦
6335	270gr	48x

 Ferramenta fixação amortecedor VAG 1.8/2.0 TFSI/TSI
 Herramienta fijación amortiguador VAG 1.8/2.0 TFSI/TSI



	VAG 1.8 / 2.0 TFSi / TSi EA888
	Audi, Seat, Škoda, VW
	T10531

REF	📏	📦
6345	1,8kg	5x

 Chave suspensão 22mm VW e Audi
 Llave suspensión 22mm VW y Audi



REF	📏	📦
6336	280gr	1x

 Chave 3/4" suspensão traseira Mercedes W163/164
 Llave 3/4" suspensión trasera Mercedes W163/164



	Mercedes ML (W163 até junho 05), (W164 a partir 05) Mercedes ML (W163 hasta junio 05), (W164 a partir 05)
---	--

REF	📏	📦
6323	545gr	24x

 Ferramenta desapertar porca suspensão 13mm VAG
 Herramienta extracción tuerca suspensión 13mm VAG



 **Medidas:** Quadra 3/8", Chave de caixa 13mm para usar com um aumento de 80mm

 **Características:** Llave de vaso cuadrada de 3/8" y 13mm para utilizar con una extensión de 80mm

REF	📏	📦
6337	177gr	96x

 Jogo chaves suspensão 19 peças
 Juego llaves suspension 19 piezas

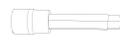

1x		
1x		21mm
7x		1/2": 16,17, 18, 19, 21, 22, 24mm
3x		1/2" 120mm: 6, 7, 8mm
3x		1/2" - 120mm: 5 x 8mm, 6 x 8mm, 7.1 x 9.6mm
1x		1/2" - 120mm: T50 - OPEL Astra H
3x		1/2" - 120mm: 7mm, Mercedes Vaneo 8mm, BMW 9mm, OPEL Corsa B, Astra F, G, Vectra B

REF

6342



4,45kg



2x

 Jogo 18 peças de chaves para suspensão
 Juego 18 piezas de llaves para suspensión

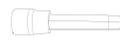

7x		16,17,18,19, 21, 22, 24mm
3x		6,7,8mm x 122mm
3x		5x8mm x 122mm, 6x8mm x 122mm (Porsche Cayenne S, VW Touareg), 7.1x9.6mm x 122mm
3x		7mm (Mercedes Vaneo) 8mm BMW 9mm Opel Corsa B, Astra F/G, Vectra B
1x		T50x122mm - Opel Astra H
1x		

REF

6340



2,5kg



1x

 Extrator pancada parafuso rótula grupo VAG
 Extractor golpe tornillo rotula grupo VAG



Audi A4/A6, VW Passat

 Usar com martelo pneumático

 Usar con martillo neumático

REF

6317



10mm



800gr



1x

 Chave para extrair rótulas Audi
 Llave para extraer rotulas Audi



Audi A4, A5, A6, A7, Q5

REF

6318



27mm



37mm



800gr



1x

 Jogo 5 peças extratores de rótulas
 Juego 5 piezas extractores de rotulas

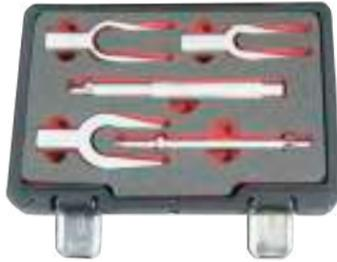

3x		18,24.5,28mm
1x		200mm
1x		200mm

REF		
2809	2,4kg	5x

 Extrator de rótulas universal
 Extractor de rotulas universal



 **Abertura:** 20-50mm

 **Apertura:** 20-50mm

REF		
4163	1,2kg	10x

 Garfo extrator eixo transmissão interno
 Horquilla extractor eje transmisión interno



 **Especificações:**
Diâmetro da alavanca de contacto: 55mm
Diâmetro da mandíbula: 85mm
Comprimento: 380mm

 **Especificaciones:**
Diámetro de la palanca de contacto: 55mm
Diámetro de la mordaza: 85mm
Longitud: 380mm

REF		
3124	1,1kg	10x

 Kit saca rótulas hidráulico
 Extractor de rótulas hidráulico



	BMW, Land Rover, Porsche, Audi etc
---	------------------------------------

 **Descrição:**
Para proporcionar diferentes posições das rótulas, as posições da pega e do punho podem ser trocadas para funcionalidade ideal
Tamanhos de abertura: 19-28mm, 26-32mm, 30-36mm
Recomenda-se o uso de uma bomba hidráulica com acionamento pneumático 8P120 JTC

 **Descripción:**
Para proporcionar diferentes posiciones de las rótulas, las posiciones del mango y de la empuñadura pueden intercambiarse para una funcionalidad óptima
Tamaños de apertura: 19-28mm, 26-32mm, 30-36mm
Se recomienda el uso de una bomba hidráulica con accionamiento neumático 8P120 JTC

REF		
6331	6,9kg	2x

 Extrator de rótulas
 Extractor de rotulas



 **Abertura:** 20mm
Largura máxima do aperto: 50mm

 **Apertura:** 20mm
Largura máxima de aperto: 50mm

REF		
6319	800gr	30x

 Kit saca rótulas com altura 125mm
 Set extractor rotulas con altura 125mm



 **Descrição:**
Tamanho mandíbulas: 20, 22, 24, 27, 30mm; Comprimento parafuso de pressão: 100mm; Comprimento haste pivot: 125mm

 **Descripción:**
Apertura de mandíbula: 20, 22, 24, 27, 30mm; Longitud del tornillo de empuje: 100mm; Longitud de la varilla de pivote: 125mm

REF		
6322	7,8kg	2x

 Kit saca rótulas abertura 30/34/40mm
 Set extractor rotulas apertura 30/34/40mm



 **Descrição:**
 Abertura mandíbulas: 30, 34, 40mm
 Comprimento parafusos: 80, 100mm
 Fuso hidráulico: Força até 12T

 **Descripción:**
 Apertura mandíbulas: 30, 34, 40mm
 Longitud tornillos: 80, 100mm
 Husillo hidráulico: Fuerza de hasta 12T

REF



6321

9,5kg

2x

 Jogo saca rótulas Mercedes
 Juego extractor rotulas Mercedes



Classe M (W163) (98-05), Classe M (W164) (post. 06), Classe E (W211) (02-06), Classe CL (W215) (02-06), Classe CLS (W219) (post. 06), Classe S (W220) (00-06), Classe SL (W/R230)

REF



6320

9kg

2x

 Jogo 7 peças para separar rótulas direção
 Juego 7 piezas para separar rótulas dirección



Audi, BMW, Citroën Ford, Peugeot, Renault, Seat, Škoda, VW,

REF



6330

400gr

20x

 Extrator rótulas camião 39mm
 Extractor rótulas camion 39mm



 **Medidas:**
 Capacidade máxima: 39mm
 Profundidade parafuso: 120mm
 Largura porca: 26mm
 Largura interior: 80mm
 Altura interior: 59mm
 Largura abertura: 39mm

 **Medidas:**
 Capacidad máxima: 39mm
 Profundidad tornillos: 120mm
 Ancho tuerca: 26mm
 Anchura interior: 80mm
 Altura interior: 59mm
 Ancho apertura: 39mm



Scania, Mercedes, MAN

REF



4164

1,5kg

8x

 Jogo saca cubos roda universal
 Juego extractor bujes ruedas universal



 **Descrição:**
Abertura até 203mm
Possibilidade de usar com 3, 4, 5 ou 6 pernas

 **Descripción:**
Apertura hasta 203mm
Possibilidad de usar con 3, 4, 5 ou 6 patas

REF		
9088	5kg	1x

 Kit remoção flange do diferencial BMW
 Kit remoción brida de diferencial para BMW



	E70, E82, E90, E91, E92, E93
	BMW

REF		
6490	4kg	2x

 Chave bihex. 43mm remoção porca eixo Mercedes
 Llave bihex. 43mm remocion tuerca eje Mercedes



	W 167: GLE, GLS W 205: C-Class 4Matic, AMG W 213: E-Class 4Matic, AMG W 238: E-Class 4Matic, AMG W 253: GLC AMG, GLC Coupé W 257: CLS 50 AMG Coupé
---	---

 **Características:**
Quadra 1: tamanho 30
Quadra 1: 1/2"
Tamanho: 43mm (ponta a ponta)

 **Características:**
Cuadrado 1: tamaño 30
Cuadrado 1: 1/2"
Tamaño: 43mm (de extremo a extremo)

REF		
6425	305gr	40x

 Chave cubo rodas 3/4" 74mm
 Llave buje ruedas 3/4" 74mm



	VW Crafter, Mercedes 511, GM Movano, Renault
---	--

 Chave desaperto cubo traseiro Ford Transit
 Llave buje ruedas trasera Ford Transit



	RWD Ford Transit 2014
---	-----------------------

REF			REF		
9074	1,035kg	20x	9089	1,25kg	12x

 Chave camiã 111mm 8F eixo BPW 12T
 Llave camión 111mm 8F eje BPW 12T



 **Medidas:** Hex 41mm x 111mm (oval)
Aplicação: BPW-12T
 Chave para o cubo do eixo traseiro

 **Medidas:** Hex 41mm x 111mm (oval)
Aplicación: BPW-12T
 Llave para el buje del eje trasero

REF		
30001	3kg	6x

 Chave cubo traseiro 95mm BPW
 Extractor buje traseiro 95mm BPW



 **Medidas:** 3/4" DR. x 95mm (oval). Comprimento total: 70mm
Aplicação: BPW 6.5~9T
 Concebido para a extração do cubo do eixo traseiro

 **Medidas:** 3/4" DR. x 95mm (oval). Longitud total: 70mm
Aplicación: BPW 6.5~9T
 Diseñado para extraer el buje del eje trasero

REF		
30002	2kg	6x

 Chave cubo traseiro 120mm BPW
 Extractor buje traseiro 120mm BPW



 **Medidas:** Hex 41x120mm (8F)
Aplicação: Reboque BPW 13-14T (de Novembro 2004)
 Extrator do cubo do eixo traseiro

 **Medidas:** Hex 41x120mm (8F)
Aplicación: Remolque BPW 13-14T (desde Noviembre de 2004)
 Extractor de buje del eje trasero

REF		
30003	3,08kg	6x

 Chave cubo rodas 109mm 8F BPW 12T
 Extractor buje ruedas 109mm 8F BPW 12T



 **Medidas:** Hex 41mm x 109mm (8F)
Aplicação: BPW-12T. Para desapertar / apertar a porca de retenção do cubo nos eixos traseiros BPW. Adequado para modelos japoneses, camiões comerciais, tratores e outros equipamentos da industria automóvel

 **Medidas:** Hex 41mm x 109mm (8F)
Aplicación: BPW-12T. Para aflojar / apretar la tuerca de sujeción del buje en los ejes traseros BPW. Adequado para modelos japoneses, camiones comerciales, tractores y otros equipos industriales de automoción

REF		
30004	2,6kg	6x

 Chave roda frontal Scania
 Llave rueda frontal Scania



 **Medidas:** Quadra 1" 8PT
 Diâmetro interior: 83mm Diâmetro exterior: 103mm Altura: 74mm
Aplicação: Eixo dianteiro SCANIA (ex. 124L / 144L), Série 4 de 96 para veículos acima de 16T, Remoção e montagem das porcas de eixo frontal do disco de travão

 **Medidas:** Cuadrado 1" 8PT
 Diâmetro interior: 83mm Diâmetro exterior: 103mm Altura: 74mm
Aplicación: Eje delantero SCANIA (ej. 124L / 144L) Serie 4 de 96 para vehículos de más de 16T, Desmontaje y montaje de las tuercas del eje delantero de los discos de freno

REF		
30005	2kg	6x

 Chave camiã 100mm 8F Scania
 Llave camión 100mm 8F Scania



 **Medidas:** Quadra 3/4" 8PT
 Diâmetro interior: 100mm, Diâmetro exterior: 123mm, Altura 84mm
Aplicação: Porca do eixo traseiro SCANIA

 **Medidas:** Cuadrado 3/4". 8PT
 Diâmetro interior: 100mm Diâmetro exterior: 123mm, Altura: 84mm
Aplicación: Tuerca del eje trasero SCANIA

REF		
30006	2,8kg	6x

 Chave parafuso feixe molas 28mm Scania
 Llave tornillo resorte de hoja 28mm Scania



 **Medidas:** 28x37mm, quadra 3/4"
Aplicação: Para reparação de camiões. Adequado para parafusos do feixe de molas SCANIA no eixo dianteiro

 **Medidas:** 28x37mm, cuadrado de 3/4"
Aplicación: Para reparación de camiones. Adequado para los pernos de la viga de resorte SCANIA en el eje delantero

REF		
30007	436gr	30x

 Chave porca eixo 85mm 6F SAF
 Llave tuerca eje 85mm 6F SAF



 **Medidas:** 85mm, Hexagonal 36mm. Comprimento: 82mm
Aplicação: Concebido para a remoção de porcas de eixo de reboque SAF

 **Medidas:** 85mm, hexagonal 36mm. Longitud: 82mm
Aplicación: Diseñado para quitar las tuercas del eje del remolque SAF

REF		
30008	1,8kg	6x

 Chave porca eixo 65mm BPW
 Llave tuerca eje 65mm BPW



 **Medidas:** Quadra 3/4" 65mm
Aplicação: Para desmontagem e montagem das porcas de eixo / cubos de roda nos eixos BPW

 **Medidas:** Cuadrado 3/4" 65mm
Aplicación: Para desmontar y montar turcas de eje / buje de rueda en ejes BPW

REF		
30009	1,01kg	16x

 Chave porca eixo 85mm BPW
 Llave tuerca eje 85mm BPW



 **Medidas:** Quadra 3/4" 85mm
Aplicação: Para desaperto e aperto de porcas de eixo / cubos de roda nos eixos BPW

 **Medidas:** Cuadrado 3/4" 85mm
Aplicación: Para aflojar y apretar tuercas tuercas de eje / bujes de rueda en los ejes BPW

REF		
30010	1,12kg	15x

 Chave porca eixo frontal 85mm BPW 13T
 Llave tuerca eje frontal 85mm BPW 13T



 **Medidas:** Quadra 3/4" 85mm
Aplicação: Para desmontagem e montagem de porcas de eixo / cubos de roda em eixos dianteiros BPW 13T

 **Medidas:** Cuadrado 3/4" 85mm
Aplicación: Para desmontar y montar tuercas de eje / bujes de rueda en ejes delanteros BPW 13T

REF		
30011	1,05kg	6x

 Chave porca eixo 95mm BPW
 Llave tuerca eje 95mm BPW



 **Medidas:** Cuadrado 3/4" 95MM
Aplicação: Para montagem e desmontagem porca eixo BPW

 **Medidas:** Cuadrado 3/4" 95MM
Aplicación: Para montar y desmontar la tuerca del eje BPW

REF		
30012	1,5kg	8x

 Chave porca eixo 110mm BPW
 Llave tuerca eje 110mm BPW



 **Medidas:** Quadra 3/4", Chave 110x45mm, Altura 72mm
Aplicação: Para desmontagem e montagem do eixo especial porca / cubo de roda nos eixos BPW

 **Medidas:** Cuadrado 3/4", Llave 110x45mm, Altura 72mm
Aplicación: Para desmontar y montar la tuerca especial del eje / bujes de la rueda en los ejes BPW

REF		
30013	1,9kg	8x

 Chave porca eixo 120mm BPW
 Llave tuerca eje 120mm BPW



 **Medidas:** Quadra 3/4", 120mm
Aplicação: Para desmontagem e montagem da porca do eixo especial / cubo de roda nos eixos BPW

 **Medidas:** Cuadrado 3/4", 120mm
Aplicación: Para desmontar y montar la tuerca especial del eje especial / bujes de la rueda en los ejes BPW

REF		
30014	2,1kg	8x

 Chave porca eixo 98mm 6F Iveco
 Llave tuerca eje 98mm 6F Iveco



 **Medidas:** Hex 36mm
Aplicação: Para desmontagem / montagem de porcas de eixo em veículos comerciais Iveco. Iveco Eurocargo e outros modelos Iveco

 **Medidas:** Hex 36mm
Aplicación: Para el desmontaje / montaje de tuercas de eje en vehículos comerciales Iveco. Iveco Eurocargo y otros modelos Iveco

REF		
30015	2,6kg	4x

 Chave porca eixo 110mm 12F Iveco
 Llave tuerca eje 110mm 12F Iveco



 **Medidas:** Hex 36mm
Aplicação: Para desmontagem / montagem de porcas de eixo especiais em veículos comerciais Iveco, Iveco Eurotech Cursor HA, etc

 **Medidas:** Hex 36mm
Aplicación: Para el desmontaje / montaje de tuercas de eje especiales en vehículos comerciales Iveco. Iveco Eurotech Cursor HA, etc

REF		
30016	2,75kg	4x

 Chave porca eixo 105mm 12F Iveco
 Llave tuerca eje 105mm 12F Iveco



 **Medidas:** Hex 36mm
Aplicação: Para desmontagem / montagem de porcas de eixo em veículos comerciais Iveco, Iveco Eurotech

 **Medidas:** Hex 36mm
Aplicación: Para el desmontaje / montaje de tuercas de eje en vehículos comerciales Iveco, Iveco Eurotech

REF		
30017	2,8kg	4x

 Chave cubo rodas 85mm 12F Iveco/SAF/BPW
 Extractor buje ruedas 85mm 12F Iveco/SAF/BPW



 **Medidas:** 85 mm, Altura: 60 mm
Aplicação: Concebido para porcas de cubo de 12 pontos em camiões Iveco e reboques BPW / SAF

 **Medidas:** 85 mm, Altura: 60 mm
Aplicación: Concebido para tuercas de cubo de 12 puntos en camiones Iveco y remolques BPW / SAF

REF		
30037	2,8kg	4x

 Chave porca eixo 95mm 6F Mercedes
 Llave tuerca eje 95mm 6F Mercedes



 **Medidas:** Hex 36mm, Comprimento 157mm
Aplicação: Concebido para a remoção da porca de eixo de reboque Mercedes

 **Medidas:** Hex 36mm, Longitud 157mm
Aplicación: Diseñado para retirar la tuerca del eje de para los remolques Mercedes

REF		
30018	2,6kg	6x

 Chave porca quadrada camião DAF/BENZ/MAN 56mm
 Llave tuerca cuadrada camión DAF/BENZ/MAN 56mm



 **Medidas:** Quadra 3/4" 56mm
Aplicação: Para aperto ou desaperto profissional da porca de eixo. DAF/BENZ/MAN

 **Medidas:** Cuadrado 3/4" 56mm
Aplicación: Para apretar o aflojar profesionalmente el tuerca del eje. DAF/BENZ/MAN

REF		
30019	1,03kg	16x

 Chave porca quadrada camião DAF/BENZ/MAN 60mm
 Llave tuerca cuadrada camión DAF/BENZ/MAN 60mm



 **Medidas:** Quadra 3/4"
Aplicação: Para desaperto e aperto profissional da porca de aperto do eixo. DAF/BENZ/MAN

 **Medidas:** Cuadrado 3/4"
Aplicación: Para aflojar y apretar profesionalmente la tuerca de sujeción del eje. DAF/BENZ/MAN

REF		
30020	937gr	16x

 Chave porca com ranhura 133-145mm MAN
 Llave tuerca con ranura 133-145mm MAN



 **Medidas:** Quadra 3/4" / 60mm hex, diâmetro interior 134mm, diâm. exterior 147mm, diâmetro argola 118mm, largura argola 11mm
Aplicação: Eixo dianteiro MAN TGA (V9821-01)

 **Medidas:** Cuadrado 3/4" / 60mm hex, diâmetro interior 134mm, diâm. exterior 147mm, diâmetro anillo 118mm, ancho anillo 11mm
Aplicación: Eje delantero MAN TGA (V9821-01)

REF		
30021	3,8kg	4x

 Chave porca eixo frontal 101-110mm MAN TGA
 Llave tuerca eje frontal 101-110mm MAN TGA



 **Medidas:** Quadra 3/4" x 93mm 6PT. Comprimento 80mm
Aplicação: Execução especial robusta concebida para remover a porca do eixo frontal. V9-82L-01 (travão de disco/ABS), etc

 **Medidas:** Cuadrado 3/4" x 93mm 6PT. Longitud 80mm
Aplicación: Ejecución robusta especial diseñada para quitar la tuerca del eje delantero. V9-82L-01 (freno de disco/ABS), etc

REF		
30022	2,6kg	6x

 Chave porca eixo traseiro com ranhura 101mm BENZ/MAN
 Llave tuerca eje trasero com ranura 101mm BENZ/MAN



 **Medidas:** Quadra 3/4", diâmetro interior 95mm, diâmetro exterior 115mm, altura 110mm
Aplicação: Eixo redutor Mercedes Benz e MAN 10+13T Eixo reboque NR7/4, autocarro 0305 G + 0405G, etc

 **Medidas:** Cuadrado 3/4", diâmetro interior 95mm, diâmetro exterior 115mm, altura 110mm
Aplicación: Ejes de transmisión de Mercedes Benz y MAN 10+13T Eje de remolque NR7/4, bus 0305 G + 0405G, etc

REF		
30023	2,9kg	4x

 Chave porca eixo transmissão c/ ranhura 101.5x110mm BENZ
 Llave tuerca eje transmision con ranura 101.5x110mm BENZ



 **Medidas:** Quadra 3/4", hex 60mm
Aplicação: Especialmente concebido com 6 dentes para remover a porca do eixo de transmissão. Camiões MAN, Mercedes Benz

 **Medidas:** Cuadrado 3/4", hex 60mm
Aplicación: Especialmente diseñado con 6 dientes para extraer la tuerca del eje de transmisión. Camiones MAN, Mercedes Benz

REF



30024

2,8kg

6x

 Chave porca eixo traseiro com ranhura 72x84mm BENZ
 Llave tuerca eje trasero con ranura 72x84mm BENZ



 **Medidas:** Dentado 11x6x12mm, diâmetro interno 72mm, diâmetro externo: 84mm. Comprimento 60mm. Quadra 32mm
Aplicação: Concebido para desapertar ou apertar a porca diferencial castelada utilizada nos Mercedes Citaro e Evo Buses

 **Medidas:** Dientes 11x6x12mm, diâmetro interno 72mm, diâmetro externo: 84mm. Longitud 60mm. Cuadrado 32mm
Aplicación: Concebido para aflojar o apretar la tuerca del diferencial almenada utilizada en los autobuses Mercedes Citaro y Evo Buses

REF



30025

677gr

27x

 Chave porca transmissão com ranhura MAN
 Llave tuerca transmisión con ranura MAN



 **Medidas:** 3/4"x 53.5mm / 4PT Comprimento total: 75mm
Aplicação: Desenhado para remover a porca de transmissão em camiões MAN

 **Medidas:** 3/4"x 53.5mm / 4PT Longitud total: 75mm
Aplicación: Diseñado para quitar la tuerca de la transmisión en los camiones MAN

REF



30026

1,3kg

12x

 Chave porca eixo transmissão MAN TGA eixos 460
 Llave tuerca eje transmision MAN TGA ejes 460



 **Medidas:** Diâmetro interior 133mm, diâmetro exterior 147,5mm, altura 155mm
Aplicação: Para desapertar/apertar a porca eixo transmissão MAN TGA460, V9-82L-01 (travão de disco / ABS)

 **Medidas:** Diâmetro interior 133mm, diâmetro exterior 147,5mm, Altura 155mm
Aplicación: Para aflojar la tuerca del eje de la transmisión MAN TGA460, V9-82L-01 (freno de disco / ABS)

REF



30027

4,6kg

4x

 Chave parafuso feixe molas 34x56mm Scania
 Llave tornillo resorte de hoja 34x56mm Scania



 **Medidas:** Quadra 3/4", 34x56mm
Aplicação: Para montagem e desmontagem dos parafusos do feixe molas

 **Medidas:** Cuadrado 3/4", 34x56mm
Aplicación: Para montar y desmontar los pernos de la viga de resorte

REF



30028

773gr

30x

 Chave parafuso feixe molas 34x46mm Scania
 Llave tornillo resorte de hoja 34x46mm Scania



 **Medidas:** Quadra 3/4", 34x46mm
Aplicação: Para montagem e desmontagem de parafusos do feixe molas

 **Medidas:** Cuadrado 3/4", 34x46mm
Aplicación: Para montar y desmontar pernos de la viga de resorte

REF



30029

646gr

30x

 Chave porca com ranhura 105-125mm BENZ
 Llave tuerca con ranura 105-125mm BENZ



 **Medidas:** Quadra 3/4", diâmetro interior 105mm, altura 180mm diâmetro exterior 125mm, diâmetro guia 116,5mm, diâmetro 10mm
Aplicação: Eixo traseiro Mercedes Benz Actros HL/HL 8 (Hypoid), etc

 **Medidas:** Cuadrado 3/4", diâmetro interior 105mm, altura 180mm diâmetro exterior 125mm, diâmetro guia 116,5mm, diâmetro 10mm
Aplicación: Eje trasero Mercedes Benz Actros HL/HL 8 (Hipoide), etc

REF		
30030	3,08kg	6x

 Chave porca com ranhura 80-95mm BENZ
 Llave tuerca con ranura 80-95mm BENZ



 **Medidas:** Quadra: 3/4" Diâmetro interior: 80mm, Diâmetro exterior: 95mm, Altura: 175mm, Pino: 87mm, Diâmetro pino: 10mm, Tubo guia: 49mm
Aplicação: Eixo traseiro Mercedes Benz Atego, Vitaro 814, MAN, etc

 **Medidas:** Cuadrado: 3/4" Diâmetro interior: 80mm, Diâmetro exterior: 95mm, Altura: 175mm, Pasador: 87mm, Diâmetro del pasador: 10mm, Tubo guía: 49mm
Aplicación: Eje trasero Mercedes Benz Atego, Vitaro 814, MAN, etc

REF		
30031	1,7kg	6x

 Chave porca roda Scania
 Llave tuerca rueda Scania



 **Medidas:** Quadra 3/4", Perfil especial com 8 dentes
Aplicação: Scania 420 (eixo basculante pesado) remoção e instalação da porca de montagem no rolamento do eixo

 **Medidas:** 3/4" cuadrado, Perfil especial con 8 dientes
Aplicación: Desmontaje y retirada del Scania 420 (eje basculante pesado) instalación de la tuerca de montaje en el cojinete del eje

REF		
30032	3kg	6x

 Chave bico injetor camiãõ
 Llave punta inyector camión

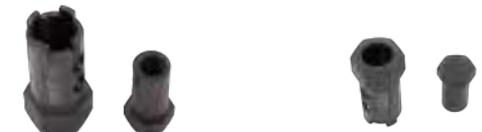

 **Medidas:** 24mm, 4 dentes, 22.2mm interior, 32mm exterior, altura: 84.5mm
Aplicação: Remoção e instalação bico do injetor Para camiões MAN 422/403 Benz, SCANIA

 **Medidas:** 24mm, 4 dientes, 22.2mm interior, 32mm exterior, altura: 84.5mm
Aplicación: Desmontaje y instalación de la boquilla del inyector Para camiones MAN 422/403 Benz, SCANIA

REF		
30033	280gr	50x

 Chave válvula injeção diesel camiãõ MAN/BENZ
 Llave valvula inyeccion diesel camion MAN/BENZ



 **Medidas:** 4 dentes, interior 22mm. exterior 28mm. altura 72mm
Aplicação: Remove e instala a válvula de injeção diesel Ferramenta reparação de camiões Adequado para camiões MAN 422/403, Benz, SCANIA

 **Medidas:** 4 dientes, interior 22mm. exterior 28mm. altura 72mm
Aplicación: Desmonta e instala la válvula de inyección diesel Herramienta de reparación de camiones Adequado para camiones MAN 422/403, Benz, SCANIA

REF		
30034	160gr	20x

 Chave 3/4" porca diferencial traseiro MAN/BENZ
 Llave 3/4" tuerca diferencial trasero MAN/BENZ



 **Medidas:** Quadra 3/4", 6 dentes
Aplicação: Camiões MAN, Mercedes Benz Para remover a porca diferencial traseiro

 **Medidas:** Cuadrado 3/4", 6 dientes
Aplicación: Camiões MAN, Mercedes Benz Para eliminar el tuerca del diferencial trasero

REF		
30035	4,1kg	4x

-  Chave 1/2" 8F 38mm tampa válvula injeção eletromagnética Scania
 Llave 1/2" 8F 38mm tapón valvula inyeccion electromagnética Scania



 **Medidas:** Altura 100mm, 8 faces. Diâmetro interior 38mm, Diâmetro exterior 45mm
Aplicação: Adequado para reboque SCANIA (340), SCANIA GENUINE nº de stock: 1529752 8075 119966 0332 5, 016 868

 **Medidas:** Altura 100 mm, 8 caras. Diâmetro interior 38mm, Diâmetro exterior 45mm
Aplicación: Adequado para remolque SCANIA (340), nº de stock: SCANIA GENUINE: 1529752 8075 119966 0332 5, 016 868

REF		
30036	450gr	30x

-  Suporte de ajuste para braço suspensão
 Palanca de ajuste para brazo de suspension



 **Aplicação:** A ferramenta extrator do braço de suspensão, para empurrar a suspensão entre outra peças, por exemplo, durante a desmontagem do eixo de acionamento ou durante a substituição do rolamento da roda

 **Aplicación:** La herramienta extractora del brazo de suspensión para empujar la suspensión entre otras partes, por ejemplo, al desmontar el eje de transmisión o al reemplazar el cojinete de la rueda

REF			
6341	1180mm	4kg	1x

-  Alavanca p/ extr. do braço oscilante suspensão e amortecedor
 Palanca para extracción cabeza brazo oscilante y amortiguador



 **Aplicação:** Especificamente projetado para puxar e segurar os braços das suspensões inferiores, para permitir a separação do cubo dos braços inferiores. Força 20NM

 **Aplicación:** Especificamente diseñado para tirar y sujetar los brazos de suspensión inferiores para permitir la separación del buje de los brazos inferiores. Fuerza 20NM

REF			
6350	970mm	6,9kg	2x

-  Separador universal de junta de suspensão
 Separador de juntas de suspensión universal



 **Descrição:** Permite a remoção e instalação de amortecedores, colunas de suspensão, apoios e rótulas, etc
 Pode ser inserido em espaços de trabalho reduzidos a partir de 3,9mm
 Também adequado para orifícios de fixação amplos, pois expande até um máximo de 15mm
 Pode ser utilizado em ambos os lados

 **Descripción:** Permite la extracción e instalación de amortiguadores, columnas de suspensión, soportes y rótulas, etc
 Puede insertarse en espacios de trabajo reducidos a partir de 3,9 mm
 También es adecuado para orificios de fijación amplos, ya que se expande hasta un máximo de 15 mm.
 Puede utilizarse en ambos lados

REF		
6347	300gr	20x

 Separador universal - mecânico
 Separador universal - mecánico

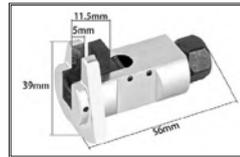

Descrição:
Concebido para separar o suporte da suspensão da caixa de rolamentos da roda
As superfícies de pressão paralelas evitam que a ferramenta salte ou escorregue acidentalmente
A sua vasta amplitude de expansão, de 5 a 11.5mm, permite a utilização em quase todos os veículos
Hexágono externo de 17mm

Descripción:
Concebido para separar o suporte da suspensão da caixa de rolamentos da roda
As superfícies de pressão paralelas evitam que a ferramenta salte ou escorregue acidentalmente
A sua vasta amplitude de expansão, de 5 a 11.5mm, permite a utilização em quase todos os veículos
Hexágono externo de 17mm

REF		
6346	130gr	45x

 Chave excêntrica axial para direção
 Llave excéntrica axial para dirección



Descrição: Parte hexagonal da extremidade usar com chave 27mm 27mm sextavada ou Roquete 1/2"

Descripción: Parte hexagonal de la extremidad usar con una llave 27mm o carraca 1/2"

REF			
1840	35-45mm	2kg	4x

 Chave excêntrica para direção 32-42mm
 Llave excéntrica para dirección 32-42mm



 Chave excêntrica para direção 25-55mm
 Llave excéntrica para dirección 25-55mm



REF				REF			
1839	32-42mm	557gr	40x	1935	25-55mm	700gr	20x

 Ferramenta universal expansão junta direção
 Herramienta universal expansión junta dirección



Descrição:
Este produto é usado para expandir a junta de direção para permitir a remoção e instalação dos amortecedores sem o risco de danificar a junta. As ferramentas são ajustáveis e adequadas para juntas de direção com um slot centralizado ou um slot não centralizado

Descripción: Este producto se utiliza para ampliar la junta de dirección para permitir la remoción e instalación de los amortiguadores sin el riesgo de dañar la junta. Las herramientas son ajustables y adecuadas para juntas de dirección con una ranura centralizada o una ranura no centralizada

REF		
1630	1,2kg	10x

 Jogo chave excêntrica axial direção com 3 cabeças
 Juego llave excéntrica axial dirección con 3 cabezas



  Ø cabeças/cabezas: 30-35, 35-40, 40-45mm

REF		
1841	6,5kg	2x

-  Saca transmissões homocinéticas com rolamento
 Extractor de juntas homocinéticas



 **Características:**
 Separa a junta homocinética do eixo sem remover o veio de transmissão
 O padrão de orifícios múltiplos permite o ajuste a diferentes profundidades. Tamanho ajustável com os rolamentos de três tamanhos

 **Características:**
 Separa la junta homocinética del eje sin desmontar el árbol de transmisión
 El patrón de agujeros múltiples permite el ajuste a diferentes profundidades. Tamaño ajustable con los cojinetes de tres tamaños

REF



6326

3,44kg

5x

-  Saca transmissões homocinéticas
 Extractor transmisiones homocinética



 **Aplicação:** Adapta-se a maioria dos veículos (excepto Seat)
 Lagura interna: 100mm. Comprimento 200mm

 **Aplicación:** Se adapta la mayoría de los vehículos (excepto Seat)
 Ancho interior: 100mm. Longitud 200mm

REF



6325

1,9kg

5x

-  Jogo 5 peças embolo esquerdo para travões
 Set 5 piezas embolo izquierdo para frenos



Citroën, Ford, Opel, Peugeot

 **Descrição:** Ferramenta essencial para o retorno do pistão de travão durante os serviços regulares das pastilhas de travão
 Inclui uma ferramenta manual de retorno rosca esquerda

 **Descripción:** Herramienta esencial para el retorno del pistón de freno durante los servicios regulares de las pastillas de freno
 Incluye una herramienta de retorno rosca izquierda

REF



5960

1,13kg

10x

-  Reposicionador de travões manual
 Reposicionador de frenos manual



 **Aplicação:** Rosca esquerda e rosca direita

 **Aplicación:** Rosca izquierda y rosca derecha

REF



5955

875gr

20x

-  Reposicionador de travões pneumático
 Reposicionador de frenos pneumático



 **Características:**
 Entrada de ar: 1/4"
 Quadra 3/8"

 **Características:**
 Entrada de aire 1/4"
 Cuadrado 3/8"

REF



5957

1,1kg

10x

 Adaptador pinças travões
 Adaptador pernos de los frenos



REF		
5966	240gr	50x

 Reposicionador de travões com roquete
 Reposicionador de frenos con carraca



 **Aplicação:** Trabalha em pistões fixo duplos e quadriláteros assim como pistões livres individuais e duplos

 **Aplicación:** Funciona en pistones fijos dobles y cuádruples, así como pistones libres individuales y dobles

REF			
5925	360°	800gr	20x

 Jogo 18 peças para recuar êmbolo travão
 Juego reposicionador pistones de frenos 18 piezas



REF		
5958	2,3kg	5x

 Chave para mola de travão de cinta
 Llave para muelle tambor de freno



REF			
1708	14-20mm	200mm	50x

  **Item - Marcas e tipos de automóveis / Marcas y tipos de coches**

- 0** - Disco de Pino único / Disco de un solo pasador de 2-1/2" para General Motors R 79 Seville, El Dorado
 - 1** - Placa de retenção / Placa de retención
 - 2** - Disco de pino único / Disco de un solo pasador de 2-1/64" para Citroën XM, Xantia (F/R)
 - 3** - Disco de três pinos / Disco de tres puntas para 2 - 5/32" para Audi R (F), Fiat/Alfa Romeo (F), Ford Fiesta(F), Honda Concesto(F), Jaguar XJ6, XJ40(F/R), BMW 318is, 320i, 325TD, 518i, 525i, 1x, 740i, 850ci, M5(F), Mitsubishi Colt(F), Nissan Mlera, Stanza, Sunny(F), Range Rover Austin, Metro, 200&400 Series, Maestra, Montego(F), Toyota Camry (F), Volvo (F), VW Passat, Golf, GTI(F)
 - 4** - Disco sem pinos / Disco sin pasador de 1-1/4" para Ford AU&NZ, Telstar, Laser(R), Mazda (R), Saab 9000(R), Fiat/Alfa Romeo 1642(R), Honda Prelude, CRS, 16i, GM Saturn, Grand Prix, Lumina(R)
 - 5** - Adaptador de 3/8"
 - 6** - Disco de dois pinos / Disco de dos pines de 1-21/32" para Nissan Primera, VW-Golf IV
 - 7** - Disco de dois pinos / Disco de dos pines de 1-21/32" para Audi 80,90, V8 100, Coupe E(R), Range Rover 800, Subaru L, Z(R), Ford Sierra, Granada, Scorpio (R), Nissan Bluebird, Silvia, Primera, Peugeot 405, 1.9Gi, Gro, Sri, Gtxi, MI, 2.0 Sri(R), Toyota Celica Corolla, GT, MR2 (R), VW Golf Gti, Jetta, Synchro, Jetta Gti, Passat CL, GL, GT, Corrado, Scirroca, GTX
 - 8** - Disco de pino único / Disco de un solo pin de 1-7/8" para General Motor
 - 9** - Disco de pino único / Disco de un solo pasador de 2-1/8" para General Motors, Cadillac Seville & El Dorado
 - A** - Disco de dois pinos / Disco de dos pasadores de 1-3/16" para Renault R21, Laguna R
 - E** - Disco de quatro pinos / Disco de cuatro pines de 1-21/32" para Cefiro, Maxima
 - F** - Disco de dois pinos / Disco de dos pasadores de 1-1/4" para Opel
 - L** - Fuso rosca esquerda / Perno de empuje izquierdo
 - K** - Disco de dois pinos / Disco de dos pasadores de 2-1/8" para Citroën e/y C5
 - M** - Disco de dois pinos / Disco de dos pasadore de 1-1/4" para Ford
 - N** - Disco hexagonal de 1-1/4" para Saab, Honda
 - R** - Fuso rosca direita / Perno de empuje derecho
- Caixa / Estuche

  **Jogo 24 peças empurrar êmbolos de travão**
Reposicionador pistones de freno 24 piezas



  **Jogo 35 peças empurrar êmbolo travão**
Juego reposicionador pistones de frenos 35 piezas



Recolhedor direito
Recogedor derecho



REF 5959FUDR

Recolhedor esquerdo
Recogedor izquierdo



REF 5959FUEQ



Item - Marcas e tipos de automóveis / Marcas y tipos de coches

- 0 - General Motors, Cadillac: Seville, Eldorado
- 1 - Placa de retenção / Placa de retención
- 2 - Citroën: XM, Xantia
- 3 - Alfa Romeo, Audi, Austin, BMW: 318iS, 320i, 325 TD, 518i, 525i, 740i, 850ci, M5, Ford: Fiesta, Honda: Concerto, Jaguar: XJ6, XJ40, Mercedes-Benz: 190, 200, 300, 420, 560, Mitsubishi: Colt, Nissan: Micra, Stanza, Sunny, Range Rover, Toyota: Camry, VW: Passat, Golf GTI, Volvo
- 4 - Alfa Romeo: 164 2.0, Fiat, Ford: Telstar, Laser, General Motors: Saturn, Grand Prix, Lumina, Honda: Prelude, CRX, Mazda, Saab: 9000, Subaru
- 5 - Quadra de 3/8"
- 6 - Nissan: Primera, VW: Golf 4
- 7 - Audi: 80 e 90, V8 e 100, Coupe, Ford: Sierra ABS, Granada e Scorpio de 1985, Honda: Prelude, Nissan: Silvia 1.8 Turbo, Bluebird Primera 2.0i, LS, GS, GSX, Rover: 8000, Saab: 9000, Subaru: L e Z, Peugeot: 405 1.9Gi, Gri, Sri, GTXI, MI16, 605 2.0 Sri, Toyota: Celica, Corolla GT, MR2, VW: Golf e Passat Cl, Gl, GT, GT 16V, 16V Corrado, Scirocco GTX 16V, Jetta Synchro, Jetta, GTI 16V
- 8 - General Motors
- 9 - General Motors, Cadillac: Seville, Eldorado
- 10 - VAG, Renault & Volvo
- A - Renault: R21, Laguna
- E - Nissan: Cefiro, Maxima
- F - Opel: Corsa, Astra, Zafira & Vectra
- LH - Fuso esquerdo / Husillo izquierdo
- RH - Fuso direito / Husillo derecho
- K - Citroën: C3, C5
- K1 - Citroën
- K2 - Citroën
- M - Ford
- N - Renault, Saab & Honda
- WK - Placa



Alfa Romeo, Audi, BMW, Citroën, Fiat, Ford Austrália, Europa, EUA, General Motors (GM), Honda, Isuzu, Jaguar, Lancia, Mazda, Mercedes-Benz, MINI, Mitsubishi, Nissan, Opel, Peugeot, Proton, Renault, Rover, Saab, Seat, Subaru, Toyota, Volkswagen, Volvo



Descrição:

Para reinicializar manualmente os pistões do travão ex.: ao substituir as pastilhas do travão
 Adequado para pinças de travão no eixo traseiro e dianteiro, com e sem função de travão de mão (não é adequado para modelos de travão de mão elétrico)
 Ferramenta de volta com rosca direita e rosca esquerda
 Suporte vazio para massa do fuso, para um funcionamento suave com os eixos de reinicializarão do pistão dos travões
 Placa de retenção, fechada, meia lua
 Placa de retenção, fechada, redonda com encaixe
 Placa de retenção, aberta, retangular
 Placa de retenção, aberta, meia lua
 Punção Ø 3 e 5 mm
 Chaves hexagonais internas 6 e 7mm



Descripción:

Para restablecer manualmente los pistones de freno, por ejemplo, al cambiar las pastillas de freno
 Adequado para pinzas de freno de eje delantero y trasero, con y sin función de freno de mano (no apto para modelos de freno de mano eléctrico)
 Girar la herramienta con rosca derecha e izquierda
 Soporte de masa de husillo vacío para un funcionamiento suave con ejes de restablecimiento del pistón de freno
 Placa de retención, cerrada, media luna
 Placa de retención, cerrada, redonda con rebaje
 Placa de retención, abierta, rectangular
 Placa de retención, abierta, media luna
 Perforación Ø 3 y 5 mm
 Llaves hexagonales internas 6 y 7mm

REF



2,04kg



5x

5962

REF



4,3kg



5x

5959

 **Jogo 44 peças empurrar êmbolo de travão**
 **Juego reposicionador pistones de frenos 44 piezas**



 **Jogo 35 adaptadores para êmbolos de travão**
 **Juego 35 adaptadores para pistones de freno**



Item - Marcas e tipos de automóveis / Marcas y tipos de coches

RD - Alfa Romeo, Audi, BMW, Citroën, Fiat, Ford, GM Motors
Honda, Iveco, Jaguar, Lancia, Mazda, Mercedes Benz, Mitsubishi
Nissan, Opel, Peugeot, Renault, Rover, Seat, Toyota, VW, Volvo
RE - Fiat, Citroën, Ford Renault
1 - Alfa Romeo, Audi, BMW, Citroën, Fiat, Ford, GM, Honda, Jaguar
Lancia, Mazda, Mercedes Benz, Mitsubishi, Nissan, Opel, Peugeot, Renault,
Rover, Saab, Seat, Subaru, Toyota
2 - Citroën, Honda, Mercedes Benz
3 - Audi A3, BMW, Citroën, Honda, Mercedes Benz
4 - Alfa Romeo, Fiat Uno, Ford, Honda, Rover
6 - Jaguar
7 - Jaguar, Opel
8 - GM Motors
9 - GM Motors
0 - Citroën
11 - Jaguar
12 - BMW Mini
A - Nissan, Opel
B - Ford, Subaru, VW Kombi
C - Nissan, Opel, Toyota
D - Citroën
E - Nissan
F - Peugeot
G - Fiat
K - Citroën
K1 - Citroën
K2 - Nissan
M - Nissan
N - Alfa Romeo, Audi, Ford, Lancia;
P - Citroën
R - Ford, Mazda, Mitsubishi, Toyota
S - Audi, BMW, Lancia, Peugeot, Renault, Rover, VW;
T - Rover
V - Rover
Q - Alfa Romeo, Fiat, Ford, Subaru
IV - Iveco, VW
H6 - BMW, BMW Mini, Opel
H7 - BMW, BMW Mini, Opel
A1 - Ford
B1 - Ford
F1 - Fiat
G1 - VW
P1 - Peugeot
R1 - Renault



Item - Marcas e tipos de automóveis / Marcas y tipos de coches

0 - Citroën
1 - Disco
2 - Citroën, Honda, Mercedes-Benz
3 - Alfa Romeo, Audi, Austin, BMW, Citroën, Ford, Honda, Jaguar,
Mercedes-Benz, Mitsubishi, Nissan, Rover, Toyota, VW
4 - Alfa Romeo, Fiat Uno, Ford, Honda, Mazda, Rover, Subaru
5 - Audi, BMW, Citroën C5, Ford, Honda, Jaguar, Mitsubishi, Nissan,
Peugeot, Rover, Toyota, Volkswagen, Volvo
6 - Nissan, Jaguar, VW
7 - Audi, Ford, Honda, Nissan, Rover, Saab, Subaru, VW, Passat, Jaguar,
Opel
8 - GM Motors
9 - GM Motors
11 - Jaguar
12 - BMW Mini
13 - Fiat
A - Nissan, Opel, Bluebird
B - Ford, Subaru, VW Kombi, Lincoln
C - Nissan, Opel, Toyota, Mini Austin
D - Citroën, Renault
E - Nissan, Cefiro, Maxima
F - Peugeot
G - Fiat, Opel
H
J - Alfa Romeo, Audi, Citroën, Fiat, Ford, Honda, Jaguar, Lancia, Nissan,
Peugeot, Renault, Seat, Subaru, Volvo
K - Citroën
L
K1 - Citroën, Renault
K2 - Nissan, Citroën, Renault
M - Nissan, Ford
N - Alfa Romeo, Audi, Ford, Lancia, Saab, Honda
O - GM Motors
P - Citroën, Audi, BMW, Ford, Lancia, Piston, Renault, Rover
R - Ford, Mazda, Mitsubishi, Toyota, Tesla
S - Audi, BMW, Lancia, Peugeot, Renault, Rover, Volkswagen
T - Rover
V - Rover
W - Renault, Volvo, Volkswagen
Q - Alfa Romeo, Fiat, Ford, Subaru

REF



5,2kg



5x

5944

REF



5kg



2x

5956

 **Jogo 7 peças auto ajustáveis para travões**
 **Juego 7 piezas auto ajustables para frenos**



	Alfa Romeo, Audi, Citroen, Ford, Honda, Jaguar, Land Rover, Mazda, Mercedes, Mini, Mitsubishi, Nissan Lancer, Toyota, VW, Volvo, Opel
---	---

REF			
5965	20-35mm	900gr	10x

 **Jogo para reparar tubos de travões**
 **Juego reparación tubos de frenos**

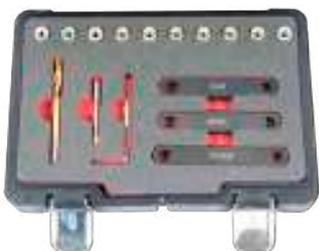

	VAG, Opel, Ford
---	-----------------

REF			
5930	M9X1.25	3,4kg	1x

 **Ferramenta para dobrar tubos de travão 3-6mm**
 **Herramienta para doblar tubos de frenos 3-6mm**



 **Descrição:**
 Este produto é projetado para dobrar três diâmetros de tubo, incluindo 3mm / 4mm / 6mm (1/8" | 3/16" | 1/4")
 Permitirá que os tubos de travão sejam dobrados em ângulos de 45° ou 90°
 Adequado para uso em tubos de alumínio, aço ou cobre

 **Descripción:**
 Este producto está diseñado para doblar tres diámetros de tubo, incluyendo 3mm / 4mm / 6mm (1/8" | 3/16" | 1/4")
 Permite que los tubos de freno se doblan en ángulos de 45° o 90°
 Adecuado para uso en tubos de aluminio, acero o cobre

REF			
5961	3,4,6mm	170gr	50x

 **Kit chaves caixa e bits para travões 17 peças**
 **Kit llaves vaso y puntas para frenos 17 piezas**



	Alfa Romeo, Audi A4, A5, S5, Q5, Q7, S8, BMW, Ford, Mercedes, Porsche: Cayenne / Macan / Cayman
---	---

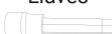

7x Bits/Puntas 	1x	1/4" - 9mm x 20mm hex
	2x	3/8" - 7,8mm x 24mm hex
	1x	3/8" - 9mm x 50mm hex
	2x	3/8" - 7mm x 70mm, 7mm x 92mm hex
	1x	3/8" - 11mm x 100mm hex
5x Chaves/ Llaves 	1x	1/2" - 11.5mmx38mm 10pt
	1x	1/2" - 15mmx38mm 10pt
	1x	1/2" - 20mmx38mm 10pt
	1x	1/2" - 22mmx38mm 7pt
	1x	1/2" - 14mmx38mm 7pt
4x Chaves/ Llaves 	4x	1/2" - 10, 12, 14, 19mm
1x Chave/Llave 	1x	1/2" - bit 10mm

REF		
5917	1,4kg	10x

 Medidor espessura discos de travão
 Medidor espesor discos de frenos



 **Aplicação:** Teste rápido e eficiente para determinar a espessura atual do disco de travão

 **Aplicación:** Prueba rápida y eficaz para determinar el espesor actual del disco de freno

REF		
5980	175gr	40x

 Purgador líquido de travão
 Purgador líquido de freno



 **Características:**
Funcionamento PSI: 90-120 PSI
Medida entrada de ar: 1/4" 18 NPT
Medidas adaptadores: (32-41 mm), (28-37 mm), (24-32 mm), (21-30 mm)
Depósitos: 1L + 0.75L

 **Características:**
Funcionamiento PSI: 90-120 PSI
Tamaño entrada de aire: 1/4" 18 NPT
Tamaños adaptadores: (32-41 mm) (28-37 mm) (24-32 mm), (21-30 mm)
Depósitos: 1L + 0.75L

REF			
2507	0,75L	700gr	10x

 Purgador líquido de travões pneumático
 Purgador líquido de frenos neumático



 **Aplicação:**
Remover e substituir o líquido da maioria dos tipos e modelos e sistemas de travão dos veículos, assim como o ar preso

Características:
Funcionamento pressão de ar: 10 a 40PSI
Consumo de ar: 4.5CFM a 30PSI
Entrada de ar: 1/4"
Capacidade líquido reservatório: 5L
Manómetros de pressão: 0~140PSI
Tubos de drenagem: 2-12-1/2 (comp.) x 0.316 (diam.) em polegadas com poliuretano transparente e ponta borracha
Mangueria de abastecimento líquido dos travões: 3000mm 3" (comprimento) X 1/2" (dia.)
Dimensões gerais: 11" (diâmetro) x 8.5" (altura) x 6.5" (diâm. base) altura total com a pega: 18"
Garrafa de recolha: 1L
Acessórios: 11 adaptadores de cilindros master

 **Aplicaciones:**
Quitar y reemplazar el líquido de la mayoría de los tipos y modelos de vehículos y sistemas de frenos, además del aire atrapado

Características:
Funcionamiento presión de aire: 10 a 40PSI
Consumo de aire: 4.5CFM a 30PSI
Entrada de aire: 1/4"
Capacidad líquido reservatório: 5L
Manómetros de presión: 0~140PSI
Tubos de drenaje: 2-12-1/2 (l.) x 0,316 (diám.) pulgadas con poliuretano transparente y punta de goma
Manguera suministro líquido frenos: 3000mm, 3" (long.) X 1/2" (dia.)
Dimensiones generales: 11" (diámetro) x 8.5" (altura) x 6.5" (diám. base), altura total con asa: 18"
Botella de recogida: 1L
Accesorios: 11 adaptadores de cilindro maestro

REF			
2508	1L	8,4kg	1x

 Adaptador sangrador travões para Tesla 3/Y
 Adaptador purgador frenos para Tesla 3/Y



 **Aplicação:** Especialmente concebido para efetuar purga dos travões nos veículos Tesla modelos 3 e Y
Descrição: Adaptadores em alumínio com rotação 360° mantêm a pressão até 2,5 BAR / 36 psi
 Compatível com a maioria das máquinas de purga de pressão dos travões ou bombas de tanques

 **Aplicación:** Especialmente diseñado para purgar los frenos de los vehículos Tesla Model 3 y Y
Descripción: Los adaptadores de aluminio con rotación de 360° mantienen la presión hasta 2,5 BAR / 36 psi
 Compatible con la mayoría de las máquinas de purga de presión de frenos o bombas de depósito

REF



2501

180gr

50x

 Adaptador sangrador travões para Tesla S/X
 Adaptador purgador frenos para Tesla S/X



 **Aplicação:** Especialmente concebido para efetuar a purga dos travões nos veículos Tesla modelos S e X
Descrição: Adaptadores em alumínio com rotação 360° mantêm a pressão até 2,5 BAR / 36 psi
 Compatível com a maioria das máquinas de purga de pressão de travões ou bombas de tanques

 **Aplicación:** Especialmente diseñado para purgar los frenos de los vehículos Tesla Model S y X
Descripción: Los adaptadores de aluminio con rotación de 360° mantienen la presión hasta 2,5 BAR / 36 psi
 Compatible con la mayoría de las máquinas de purga de presión de frenos o bombas de depósito

REF



2502

180gr

50x

 Adaptador sangrador travões para Hyundai
 Adaptador purgador frenos para Hyundai



Hyundai, Mitsubishi, Nissan

 Chave pentagonal nº10 para travões
 Llave pentagonal nº10 para frenos



REF



1597

100gr

1x

 **Descrição:** Adaptador angular de 90° para áreas restritas

 **Descripción:** Adaptador con ángulo de 90° para zonas restringidas

REF



2503

120gr

50x

 Sangrador travões/embragens automático 220v
 Sangrador frenos/embrague 220v



 **Características:**
 Tensão: 220-240V 50/60Hz
 Potência Máx.: 35W
 Pressão de trabalho: 0.6-3.0 Bar
 Caudal máx. Taxa de fluxo: 1.2 L/min
 Dimensão: 285 x 230 x 370mm
 Peso: 4Kg
 Comprimento da mangueira de enchimento: 3.5M
 Proteção do recipiente vazio: Sim
 Nível de ruído: 70dB

 **Características:**
 Tensión: 220-240V 50/60Hz
 Potencia máx.: 35W
 Presión de trabajo: 0.6 – 3.0 Bar
 Caudal máx.: 1.2 L/min
 Dimensiones: 285 x 230 x 370mm
 Peso: 4Kg
 Longitud de la manguera de llenado: 3.5M
 Protección del contenedor frente al vaciado: Sí
 Nivel sonoro: 70dB

REF



2511

4kg

1x

 Sangrador de travões e embraiagem
 Purgador de frenos y embrague



 Extrator fluídos manual / pneumático 6L
 Extractor líquidos manual / neumático 6L



 **Características:**
Pressão de funcionamento 2BAR / 30psi
(pressão máxima 5BAR / 70psi)
O intervalo de pressão torna a unidade adequada para uso com sistemas de ABS
Equipado com tampa Ø42mm com conector angular 90° que é adequado para a maioria dos carros europeus

 **Características:**
Presión de funcionamiento 2BAR / 30psi
(presión máxima 5BAR / 70psi)
El rango de presión hace que la unidad sea adecuada para su uso con sistemas ABS
Equipado con tapa Ø42mm con conector angular 90° que es adecuado para la mayoría de los coches europeos

REF			
2509	2,5L	1,5kg	6x

 **Características:**
Pressão trabalho: 85-120PSI
Capacidade: 6L
Entrada de ar: 1/4"
Funcionamento: Manual / Pneumático
Aplicação: Óleos lubrificantes, ATF, líquido refrigerante, água, outros fluídos de baixa viscosidade

 **Características:**
Presión de trabajo: 85-120PSI
Capacidad: 6L
Entrada de aire: 1/4"
Funcionamiento: Manual / Neumático
Aplicación: Aceites lubricantes, ATF, refrigerantes, agua, otros fluidos de baja viscosidad

REF		
2510	2,4kg	1x

 Adaptador ajustável sangrador travões universal 28-70mm
 Adaptador purgador frenos universal ajustable 28-70mm



 **Características:**
Adequado para todos os veículos com reservatório do fluido dos travões
Suporta uma pressão até 3.5 bar (50 psi)

 **Características:**
Apto para todos los vehículos con depósito de líquido de frenos
Admite una presión de hasta 3.5 bar (50 psi)

REF		
2504	541gr	24x

 Extrator de volante direção Opel
 Extractor de volante dirección Opel



Opel, Vectra B, Zafira B, Omega B, Tigra A

-  **Aplicações:**
 Utilização em conjunto com chave/chave de caixa de 17mm
 Extrator de 2 pernas e porca de empurrar
-  **Aplicaciones:**
 Utilizar junto con la llave/llave de vaso de 17mm
 Extractor de 2 patas y tuerca de empuje

REF

1380



39,8mm



633gr



30x

 Jogo saca volantes
 Juego extractor volantes



1x		
3x		8x1.25x100mm
3x		8x1.25x80mm
3x		10x1.25x100mm

3x		10x1.5x50mm
3x		5/16" UNC x 2"
2x		5/16" UNFx3-1/2"
3x		5/16" UNCx4-1/2"
3x		3/8" UNC x 4"
3x		3/8" UNF x 2"
3x		1/4" UNF x 3"
2x		3/8" x 20mm
2x		5/16" x 18mm
2x		1/4" x 19mm

REF

8925



32-90mm



3kg



4x

 Kit porcas e pinos roscados M8/M10
 Kit tuercas y pernos roscados M8/M10



Alfa Romeo, BMW, Chrysler, Citroën, Fiat, Ford, Mazda, Nissan, Peugeot, Porsche, Honda, Opel, Saab, Renault, Volvo, grupo Volkswagen Audi, etc

 **Composição: Pinos roscados:** (5x) M8x1.25x35mm, (5x) M8x-1.25x45mm, (5x) M8x1.25x35mm, (5x) M8x1.25x47mm, (5x) M8x1.25x37mm, (5x) M8x1.25x47mm, (5x) M8x1.25x41mm, (5x) M8x1.25x42mm, (5x) M8x1.25x43mm, (5x) M10x1.5x38mm, (5x) M10x-1.5x40mm, (5x) M10x1.5x54mm **Porcas cobre:** (10x) M8x1.25x13mm hex, (10x) M10x1.5x14mm Hex **Porcas latão:** (10x) M8 x 1.25 x 13mm Hex, (10x) M10x1.5x17mm Hex.

 **Composição: Pinos roscados:** (5x) M8x1.25x35mm, (5x) M8x-1.25x45mm, (5x) M8x1.25x35mm, (5x) M8x1.25x47mm, (5x) M8x1.25x37mm, (5x) M8x1.25x47mm, (5x) M8x1.25x41mm, (5x) M8x1.25x42mm, (5x) M8x1.25x43mm, (5x) M10x1.5x38mm, (5x) M10x-1.5x40mm, (5x) M10x1.5x54mm **Porcas cobre:** (10x) M8x1.25x13mm hex, (10x) M10x1.5x14mm Hex **Porcas latão:** (10x) M8 x 1.25 x 13mm Hex, (10x) M10x1.5x17mm Hex.

REF

4403



1,44kg



10x

 Kit chaves para porca com furo
 Juego llaves para tuercas con agujero

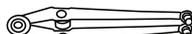

8x		2.5-4mm, 3-5mm, 6-8mm, 7-9mm
1x		10-12mm
1x		

REF

6430



1,53kg



5x

 Kit extractores volante para motas
 Set extractores volante para motos



 **Aplicação:** O kit de 10 peças serve para 15 aplicações diferentes, excetuando a M27 que têm rosca direita de aperto manual
Medidas: M19xP1.0, M14xP1.5, M26xP1.5, M22xP1.5, M16xP1.5, M18xP1.5, M27xP1.0L, M24xP1.0, M27xP1.25, M20xP1.0, M25xP1.5, M22xP1.0, M26xP1.0, M28xP1.0, M28xP1.5

 **Aplicación:** El kit de 10 piezas es adecuado para 15 aplicaciones diferentes, excepto para M27 que tiene una rosca de apriete derecha
Medidas: M19xP1.0, M14xP1.5, M26xP1.5, M22xP1.5, M16xP1.5, M18xP1.5, M27xP1.0L, M24xP1.0, M27xP1.25, M20xP1.0, M25xP1.5, M22xP1.0, M26xP1.0, M28xP1.0, M28xP1.5

REF		
6449	2,3kg	5x

 Kit para cortar porcas 4 peças
 Kit para cortar tuercas 4 piezas



 **Medidas:** 9-12mm, 12-16mm, 16-22mm, 22-27mm

 **Medidas:** 9-12mm, 12-16mm, 16-22mm, 22-27mm

REF		
6435	1,7kg	10x

 Extrator vedante da cambota
 Extractor sello del cigüeñal



	VAG, Ford
---	-----------

REF			
6442	32,55mm	1,95kg	10x

 Saca vedantes ajustável
 Saca retenes ajustable



 **Descrição:** Extrator tipo gancho para extrair orings e vedantes
2 tamanhos de ganchos para fácil remoção
Cabeça pode ser ajustada em diferentes posições
O ajuste com mola permite que a cabeça seja movida para permitir o acesso a áreas difíceis
Cabo revestido de borracha para maior conforto e aderência ao usar esta ferramenta, além de antiderrapante
Para remover vedantes e orings em carros, carrinhas e camiões. O comprimento total da ferramenta é 330mm

 **Descripción:** Extractor de gancho para extraer orings y retenes
2 tamaños de gancho para una fácil extracción
La cabeza se puede ajustar en diferentes posiciones
El ajuste con resorte permite mover la cabeza para permitir el acceso a áreas difíciles
Mango recubierto de goma para mayor comodidad y agarre al utilizar esta herramienta, además de antideslizante
Para quitar retenes y orings en coches, camionetas y camiones. Longitud total de la herramienta es de 330mm

REF		
6327	400gr	20x

-  Kit substituição vedante de embraiagem a seco Ford/Volvo
 Kit extraer y instalar reten de embrague en seco Ford/Volvo



	Transmissão/Transmisión: DPS6 Volvo, Ford
	307 671, 307 672, 307 673, 307 674

REF		
6434	2,2kg	5x

-  Jogo 20 peças sacar/colocar vedantes
 Juego 20 piezas extraer/colocar retenes



-  
 Aplicação/Aplicación: Universal

REF			
6314	27-58mm	3,8kg	2x

-  Extrator vedante da cambota VW
 Extractor sello del cigüeñal VW



	VW: Lupo 1.4/1.6, Polo 1.4/1.6, Polo, Classic 1.4 Golf/Bora 1.4/1.6, Beetle 1.4, Caddy 1.4 16v. Seat: Arosa 1.4, Ibiza 1.4, Cordoba 1.4, Leon 1.4/1.6, Toledo 1.4/1.6, Inca 1.4 16v, Škoda: Fabia 1.4, Fabia II 1.6, Octavia 1.4, Roomster 1.4 16v
---	--

REF			
6444	M6x35mm	600gr	1x

-  Kit instalar e extrair vedante traseiro cambota VAG
 Kit instalador y desmontar reten trasero cigüeñal VAG



	1.8 Turbo, 2.0 Turbo (CCTA, CBFA), 3.0 supercharged V6 (CCAA, CGXB, CTUB), 3.2 (BKH), 4.2 (BNK, BVJ)
	VW, Audi
	T10122C

REF		
6436	3kg	5x

-  Extrator vedante da cambota VW
 Extractor sello del cigüeñal VW



	1.4iTurbo, 1.4/1.6 injeção directa/ inyección directa (gas.) 1.9/2.0SDI, 2.0TDi, 2.0 Common Rail (diesel)
	VW Golf, Touran, Audi A3, A4

REF			
6445	M6x35mm	1,7kg	10x

 Extrator vedante cambota Mercedes
 Extractor sello del cigüeñal Mercedes



	M102, 111, 112, 113, 137, 156, 159, 272, 275, 285, 601, 602, 603, 604, 605, 606, 628, 629
	119589011400, 11589084300

REF		
6451	4,5kg	2x

 Extrator vedante da cambota Mercedes M651
 Extractor sello del cigüeñal Mercedes M651



	M651
	651589006100 / 651589016100

REF		
6452	5kg	2x

 Jogo p/ sacar e instalar vedante da cambota diant. e tras. BMW
 Juego para extraer y instalar cigüeñal delant. y tras. BMW

 Kit sacar e instalar vedante da cambota frontal e traseiro BMW
 Juego p/ extraer y instalar cigüeñal delantero y trasero BMW



	BMW N40, N42, N45, N45T, N46, N46T, N52, N53, N54
	BMW

REF		
6438	4kg	5x

	BMW N40/N42/N45/N45T/N46/ N46T/N52/ N53/N54/N55
	BMW
	11 9 220, 11 9 230, 11 9 235

 Jogo 10 peças sacar/colocar rolamentos e vedantes
 Juego 10 piezas extraer/colocar rodamientos y retenes



 Medidas: 39.5, 44.5, 50, 59, 63, 65, 72, 76, 81mm
 Medidas: 39.5, 44.5, 50, 59, 63, 65, 72, 76, 81mm

REF			REF		
6437	9kg	1x	6312	1,9kg	5x

 Jogo 19 peças para sacar rolamentos 62/66/72mm
 Juego 19 piezas para sacar rodamientos 62/66/72mm



	62mm: VW Lupo, Audi A2, 66mm: VW Fox, VW Polo Škoda Fabia, 72mm: VW Polo, Seat Ibiza, VW Fox, Audi A1, A2, Seat Cordoba Škoda Fabia, Škoda Roomster
---	---

REF		
6313	12kg	1x

 Jogo 16 peças sacar rolamentos 66mm
 Juego 16 piezas sacar rodamientos 66mm



	VW Fox, VW Polo, Škoda Fabia
---	------------------------------

REF		
6366	10,5kg	2x

 Jogo 16 peças sacar rolamentos 62mm
 Juego 16 piezas sacar rodamientos 62mm



	VW Lupo, Audi A2
---	------------------

REF		
6362	10kg	2x

 Jogo 16 peças sacar rolamentos 72mm
 Juego 16 piezas sacar rodamientos 72mm



	Audi A1, Audi A2, Seat Cordoba, Seat Ibiza, Škoda Fabia, Roomster, VW Polo, VW Fox
---	---

REF		
6372	6,5kg	2x

 Jogo 13 peças para sacar rolamentos 78mm
 Juego 13 piezas para sacar rodamientos 78mm

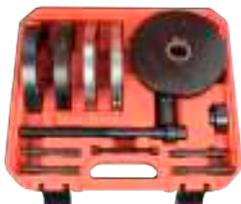

	Ford Focus II, C-Max, Volvo C30, C70, S40, V50 (Front), Mazda 3
---	--

REF		
6378	10,5kg	2x

 Jogo 16 peças para sacar rolamentos 85mm
 Juego 16 piezas para sacar rodamientos 85mm



	VW Multivan, Touareg, Transporter
---	-----------------------------------

REF		
6385	7,5kg	2x

 Jogo 19 peças para sacar rolamentos 82mm
 Juego 19 piezas para sacar rodamientos 82mm



	Ford Mondeo, Galaxy, S-Max, Land Rover, Freelander 2, Volvo S80, V70, XC60, XC70
---	--

REF		
6382	10kg	2x

 Jogo 9 peças para sacar rolamentos 90mm
 Juego 9 piezas para sacar rodamientos 90mm



	A4/S4 QuattroAvant, A6/S6 Quattro Avant A8/S8 QuattroAvant, R8
---	--

REF		
6390	7kg	2x

 Jogo para remover e colocar rolamento
 Juego para extraer y colocar rodamientos



	Audi, VW. VW T5, Touareg, Škoda, Seat
---	---------------------------------------

 Diâmetro rolamentos: 62, 66, 72, 85mm		
 Diámetro rodamientos: 62, 66, 72, 85mm		
REF		
6316	22kg	1x

 Kit saca casquilhos suspensão traseira toyota
 Extractor casquillos suspension trasera toyota



REF		
6309	10,5kg	1x

 Saca casquilhos suspensão Ford/Volvo
 Extractor casquillos brazo suspensión Ford/Volvo



	Ford; Mondeo Mk IV (07), S Max (06), Galaxy (06), Volvo S60, S80, XC60, V70, XC70 (06-09)
---	---

 Características: Adequado para a remoção / instalação casquillos montados no braço traseiro de veículos Ford Também adequado para alguns veículos Volvo que compartilham a mesma estrutura Ford		
 Características: Adequado para quitar / instalar casquillos montados en el brazo trasero de vehículos Ford También es adecuado para algunos vehículos Volvo que comparten la misma estructura de Ford		
REF		
6310	10kg	2x

	Toyota Avensis M2, Corolla, Corolla Verso E12, Previa R3, Yaris P10 / P13, Yaris Verso P20, P21, P22, Camry, Picnic XM1
	48725 28050/28725 44050 48725 02220/48725 12570 487250D040 / 48725 B1010 / 1014001675/4872552010 / 4872552011/4872552021 / 4872552030

 Jogo 26 peças para remover e colocar rolamentos e casquilhos
 Juego 26 piezas extractor y instalador rodamientos y cojinetes

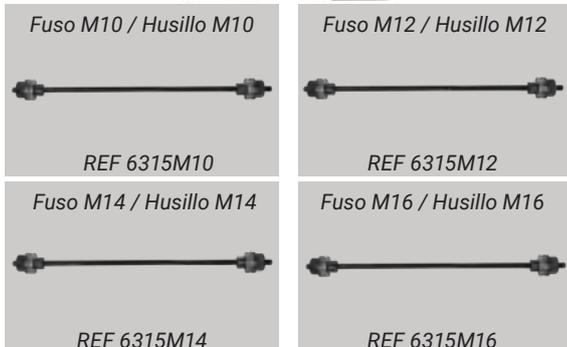

4x		Fusos/Husillos 450mm: M10x1.5 / 33NM, M12x1.5 / 60NM, M14x1.5 / 99NM, M16x1.5 / 155NM
11x		"A": D44xd34, D46xd36, D54xd44, D56xd46, D58xd48, D66xd56, D68xd58, D70xd60, D78xd68, D80xd70, D82xd72
9x		"B": D48xd38, D50xd40, D52xd42, D60xd50, D62xd52, D64xd54, D72xd62, D74xd64, D76xd66
2x		Placas de extremidade / Placas de extremo

 **Aplicação:** Casquilhos com aplicação universal para a maioria das marcas. Facilita o trabalho para remover e instalar: rolamentos, sinoblocos, sinoblocos hidráulicos, casquilhos manga eixo

 **Aplicación:** Cojinetes con aplicación universal para la mayoría de las marcas. Facilita el trabajo para extraer e instalar: rodamientos, bujes, bujes hidráulicos, cojinetes eje de manga

REF

6315



19kg



1x

 Extrator casquilhos suspensão traseira BMW série 1/3
 Kit casquillos suspension trasera BMW serie 1/3



Serie 1 - E81, E82, E83, E85, E86, E87, E88, F20, (04-12)
 Serie 3 - E90, E91, E92, E93 (04-12)

 **Características:**
 Desenhado para extração e instalação do casquilho da suspensão traseira nos BMW Série 1 e 3

 **Características:**
 Diseñado para la extracción e instalación del casquillo de suspensión trasera en los BMW Serie 1 y 3

REF

6311



2,1kg



4x

 Extrator casquilho diferencial traseiro BMW F-serie
 Extractor casquillo diferencial trasero BMW F-serie



5, 6, 7 Serie F01, F02, F04, F06, F07, F10, F11, F12, F13, F18



330 030 (330 031, 330 032, 330 033, 330 034, 330 035, 330 036)

REF

6307



4kg



5x

 Extrator casquilho diferencial frontal BMW F-serie
 Extractor casquillo diferencial delantero BMW F-serie



5, 6, 7 Serie F01, F02, F04, F06, F07, F10, F11, F12, F13, F18



330 020

REF

6308



3,4kg



5x

 Kit saca silent block VW polo, Škoda Fabia
 Juego extractor silentblock VW eje delantero



	Audi A2, VW Polo IV (9N) (02-05), Škoda Fabia I, Seat Ibiza (6L) (02-06), Cordoba (a partir 02)
---	---

REF		
6301	1,5kg	5x

 Kit saca silent block Fiat roda traseira
 Juego extractor silent block Fiat eje trasero



	Fiat Stilo (01-07), Bravo (07), Lancia Delta (08)
---	---

REF		
6302	2kg	5x

 Ferramenta ajuste profundidade rolamento caixa DSG VAG
 Herramienta ajuste profundidad rodamiento caja DSG VAG



	DSG (7 velocidades) encontradas/presentes na gama / en la gama VAG de 2011, Volkswagen / Audi
	T10466

REF		
3120	4kg	4x

 Kit saca universal para caixa rolamento de roda
 Kit extractor universal para caja rodamiento rueda



	Audi, BMW, Citroën, Ford, Peugeot, Seat, Škoda, VW etc
---	--

 Características: Fuso M20*1,5 Comprimento fuso: 200mm Pressão: Ø34mm	Largura braços: 27mm Comprimento exterior: 98mm Intervalo de uso: Ø50~120
 Características: Husillo M20*1.5 Longitud del eje: 200mm Presión: Ø34mm	Ancho de brazos: 27mm Longitud exterior: 98mm Rango de uso: Ø50~120

REF		
6300	2,8kg	10x

 Ferr. Sacar/colocar casquilhos motor elétrico - Tesla Model 3
 Extractor/instalador casquillos Tesla Model 3 electric motor



Tesla Model 3

REF

6328



1,9kg



10x

 Jogo 63pcs sacar/colocar rolamentos e casquilhos hidráulico
 Extractor/instalador rodamientos y casquillos 63pzs hidráulico



 **Características:**

Para desmontagem e montagem de vários rolamentos, rolamentos de esferas e vedantes, de Ø18 a Ø88mm
 Acionado por um cilindro hidráulico que se conecta a uma bomba manual ou de pé

Inclui:

Cilindro hidráulico: força máxima 18,2 T
 55 mangas curtas e longas com diferentes diâmetros, de Ø18 a Ø88 mm
 4 extensões com diferentes diâmetros: Ø10, Ø12, Ø14 e Ø16 mm
 Rosca do fuso hidráulico: PT 3/8"-19
 Rosca do adaptador: M24.5×P1.25

 **Características:**

Para el desmontaje y montaje de varios rodamientos, rodamientos de bolas y sellos, de Ø18 a Ø88 mm
 Accionado por un cilindro hidráulico que se conecta a una bomba manual o de pedal

Incluye:

Cilindro hidráulico: fuerza máxima de 18,2 T
 55 casquillos cortos y largos con diferentes diámetros, de Ø18 a Ø88 mm
 4 extensiones con diferentes diámetros: Ø10, Ø12, Ø14 y Ø16 mm
 Rosca del husillo hidráulico: PT 3/8"-19
 Rosca del adaptador: M24.5×P1.25

REF

6329



22kg



1x

 Saca rolamentos cabeça direção/eixos para motos
 Kit sacar rodamientos cabeza/eje dirección para motos



1x	
1x	
1x	
7x	 32, 36, 38, (3x) 42, 46mm



Kawasaki, Honda, Harley Davidson

REF

9326



6,2kg



2x

 Saca 2 braços
 Extractor 2 brazos



REF	⊕	⊥	⚖	📄
7110	90mm	100mm	960gr	20x
7111	120mm	100mm	1,05kg	20x
7112	150mm	150mm	2,6kg	6x
7113	200mm	150mm	3kg	6x
7114	250mm	200mm	7,5kg	3x
7115	350mm	200mm	8kg	2x

 Jogo 14 peças sacas de meia lua
 Juego 14 piezas extractores de media luna

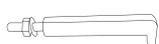
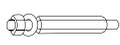
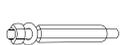

1x		50mm
1x		76mm
1x		
1x		180mm
2x		
4x		100mm
4x		130mm

REF	⚖	📄
9312	5kg	2x

 Jogo 21 peças sacas com fuso hidráulico
 Set 21 piezas extractor con husillo hidráulico



Aumento M. / Alarg.M.



REF 9087AM

Aumento F. / Alarg. H



REF 9087AF

Perna 4" / Pierna 4"



REF 9087P

Travessa / traviessa



REF 9087T

Fuso / husillo



REF 9087F

Saca 1/2" / Extr. 1/2"



REF 9087S

Perna 8" / Pierna 8"

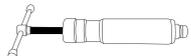

REF 9087P8

1x		Adaptador
1x		Adaptador
3x		100 mm (4")
3x		150 mm (6")
3x		200 mm (8")
1x		
1x		
1x		Adaptador Rosca Fuso / Adaptador Rosca Husillo
2x		
1x		1/2" 140-620mm
2x		
2x		Adaptador Fuso / Adaptador Husillo

REF

9087



5T



17kg



2x

 Jogo 13 peças saca 2 e 3 pernas com 3 profundidades
 Juego 13 piezas extractores 2 y 3 pernas con 3 profundidades

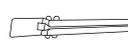
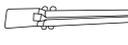
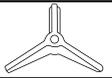
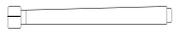

3x		100mm
3x		210mm
3x		260mm
1x		170mm
1x		150mm
1x		150mm
1x		250mm

REF

9320



170mm



8kg



2x

 Kit extração por inércia com fuso hidráulico
 Kit extracción inercial con husillo hidráulico



VW, Audi Seat, Škoda, Opel, Volvo, Fiat, Renault, Peugeot, Citroën, etc

 **Descrição:** Inclui 3 extratores/martelos: fuso hidráulico, parafuso, martelo de impacto. Adequado para quase todos os cubos de 3, 4, 5 e 6 furos. Usado para pressionar o eixo do cubo
Eixo hidráulico com capacidade de 10T

 **Descripción:** Incluye 3 extractores / martillos: husillo hidráulico, tornillo, martillo de impacto. Apto para casi todos los bujes de 3, 4, 5 y 6 agujeros. Se utiliza para presionar el eje del buje
Eje hidráulico con capacidad de 10T

REF



6355

13,5kg

1x

 Extrator 5ª velocidade Ford
 Extractor 5ª engranaje Ford



Ford Fiesta: com caixa de velocidades IB5 - todos os modelos até à data, mais os modelos mais antigos com caixa de velocidades B5 / Caja de cambios IB5: todos los modelos hasta la fecha, además de los modelos más antiguos con caja de cambios B5
Focus: Mk1, Mk2, Mk3 - todos os modelos até à data, mais os modelos mais antigos com caixa de velocidades MTX75 / todos los modelos hasta la fecha, más modelos más antiguos con caja de cambios MTX75
KA: todos os modelos/todos los modelos; Mondeo;
C-Max, Galaxy: todos os modelos com caixa de velocidades de 5 velocidades / todos los modelos con caja de cambios de 5 velocidades
EcoSport, Fusion: todos os modelos com caixa de velocidades de 5 velocidades / Todos los modelos con caja de cambios de 5 velocidades;
Transit FWD, Transit Connect - todos os modelos com caixa de 5 velocidades / Todos los modelos con caja de cambios de 5 velocidades

 **Descrição:** Método rápido e simples de remover a quinta mudança nas transmissões Ford de tração frontal antes de efetuar reparações internas. O colarinho bipartido e a manga de retenção garantem uma localização adequada

 **Descripción:** Método rápido y sencillo para desmontar la quinta marcha en las transmisiones Ford de tracción delantera antes de realizar reparaciones internas. El collarín dividido y el manguito de retención garantizan una ubicación adecuada

REF



3110

2kg

5x

 Saca de 3 pernas com fuso hidráulico
 Extractor de 3 patas con husillo hidráulico



REF



8934
8935

75-150mm
70-200mm

1,2kg
1,2kg

1x
1x

-  Extrator de rolamentos de esferas
 Extractor para rodamientos con esferas falsas



 **Descrição:**

Adequado para remoção de uma variedade de rolamentos cegos onde os extratores tradicionais de rolamentos e engrenagens não alcançam. Pontas de extremidade esférica se encaixam dentro das pistas de rolamento para fornecer tração para extração de rolamentos. Ideal para uma ampla variedade de rolamentos.

Medidas: 5, 6, 8, 9, 11, 12,5mm

 **Descripción:**

Adequado para quitar una variedad de cojinetes ciegos donde los extractores tradicionales de cojinetes y engranajes no pueden alcanzar. Las puntas de los extremos esféricos encajan dentro de las pistas de rodadura para proporcionar tracción para extracción de cojinetes. Ideal para una amplia variedad de rodamientos.

Medidas: 5, 6, 8, 9, 11, 12,5mm

REF

9325



2,5kg



5x

-  Jogo sacas interiores 16 peças
 Juego extractor interiores 16 piezas



 **Composição:**

(10x) Extratores: 8-11,12-17,18-23,24-29,30-34,34-38, 39-43, 44-48,49-53,54-58mm
 (1x) Parafuso extrator
 (3x) Redutores: M10x1.5, M10x1.5/M8x1.25, M10x1.5/M6x1
 (1x) Extrator de pancada
 (1x) Extrator de 2 pernas

 **Composición:**

(10x) Extractores: 8-11,12-17,18-23,24-29,30-34,34-38,39-43, 44-48,49-53,54-58mm
 (1x) Tornillo extractor
 (3x) Reductores: M10x1.5, M10x1.5/M8x1.25, M10x1.5/M6x1
 (1x) Extractor de golpe
 (1x) Extractor de 2 patas

REF

2991



6,5kg



2x

 Saca 3 pernas interiores
 Extractores 3 piernas interiores



 **Aplicação:** Ideal para rolamentos de volante, rolamentos de bomba e rolamentos gerador/arrancador, todos os rolamentos sem inclinação ou irá danificar a pista do rolamento
Diâmetro: 16-50.8mm

 **Aplicación:** Ideal para cojinetes de volante, cojinetes de bomba y cojinetes de generador / arranque, todos los cojinetes sin inclinación o dañarán la pista de rodadura del cojinete
Diámetro: 16-50.8mm

REF			
2992	16-50.8mm	950gr	20x

 Braço para amarrar polias
 Mango para amarre poleas



Pino / Perno



REF 6110S

 **Aplicação:** Ferramenta universal para bloquear a polia de distribuição Usada para bloquear a árvore de cames ou bomba de injeção e correia

 **Aplicación:** Herramienta universal para bloquear la polea de distribución Se utiliza para bloquear el árbol de levas y la bomba de inyección y correa

REF			
6110	400mm	1,25kg	20x

 Micro extrator para rolamentos
 Micro extractor para rodamientos



Perna / Pata



REF 8933P

Rolamentos / Rodamientos ISO

606, 607, 609, 626, 627, 628, 629, 636, 637, 638, 639, 668, 688, 689, 697, 698, 699, 6001, 6002, 6003, 6200, 6201, 6202, 6300, 6301, 6302, 6800, 6801, 6802, 6803, 6900, 6901, 6902, 6903.ions

 **Características:**
Capacidade: 1 tonelada
Alcance extrator (Min-Max):19-73mm
Expansão extrator (Min-Max):19-45mm

 **Características:**
Capacidad: 1 tonelada
Alcance del extractor (Min-Max): 19-73mm
Expansion del extractor (Min-Max): 19-45mm

REF			
8933		1,25kg	10x

 Micro extrator para rolamentos
 Micro extractor para rodamientos



 **Aplicação:** Utilizado para segurar e estabilizar a engrenagem enquanto o parafuso do eixo de cames é removido Permite o correto ajuste da engrenagem de cames uma vez concluída a instalação a instalação

 **Aplicación:** Se utiliza para sujetar y estabilizar el engranaje mientras se retira el perno del árbol de levas Permite el ajuste correcto del engranaje de la leva una vez que se ha completado la instalación

REF			
6109		300gr	60x

Chave de remoção de polias em V
 Llave para extracción de poleas en V

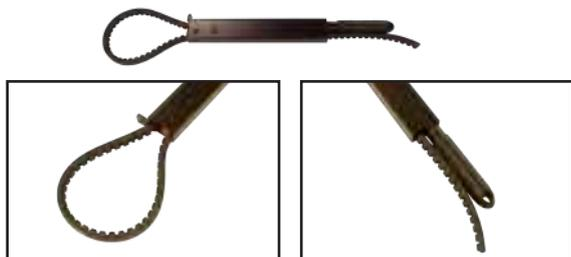

Aplicação: Ideal para a bomba de água, polias do alternador e várias polias de motor elétrico de compressores, máquinas de lavar máquinas de ferramentas, etc. Também adequado para rodar a árvore de cames quando sincroniza o motor e para remover os filtros de óleo e gasolina

Capacidade: 40-140mm

Comprimento: 365mm

Aplicación: Ideal para bombas de agua, poleas alternador y varias poleas de motor eléctrico para compresores, lavadoras, máquinas herramienta, etc. También es adecuado para hacer girar el árbol de levas al sincronizar el motor y para retirar los filtros de aceite y gasolina

Capacidad: 40-140mm

Longitud: 365mm

REF

7170



555gr



36x

Chave remoção polias em V-POLI
 Llave para extracción de poleas en V-POLI



Aplicação: Ideal para a bomba de água, polias do alternador e várias polias de motor elétrico de compressores, máquinas de lavar máquinas de ferramentas, etc. Também adequado para rodar a árvore de cames quando sincroniza o motor e para remover os filtros de óleo e gasolina

Capacidade: 40-140mm

Comprimento: 365mm

Aplicación: Ideal para bombas de agua, poleas alternador y varias poleas de motor eléctrico para compresores, lavadoras, máquinas herramienta, etc. También es adecuado para hacer girar el árbol de levas al sincronizar el motor y para retirar los filtros de aceite y gasolina

Capacidad: 40-140mm

Longitud: 365mm

REF

7175



583gr



36x

Extrator polia da cambota BMW N47/N57
 Extractor pola del cigüeñal BMW N47/N57



	BMW N47, N57
	BMW
	117220

REF

7166



2,5kg



5x

Kit tirar e colocar correias elásticas carros europeus
 Set instalador de flexi-correas coches europeos



Kit tirar e colocar correias elásticas carros europeus
 Set instalador de flexi-correas coches europeos



BMW, Chrysler, Citroën, Fiat, Ford, Iveco Daily, Mazda, Mercedes Sprinter, Peugeot, Volvo

Aplicação: Para carros europeus posteriores ao ano 2004

Aplicación: Para coches europeos posteriores al año 2004

REF

6118



1,05kg



10x

REF

6115



500gr



1x

 Jogo de 5 chaves luneta curva
 Juego de 5 llaves acodadas curvas



 **Características:**
Luneta Bihexagonal
Com pega antiderrapante para fácil manuseamento
As extremidades com ângulo 45° permitem alcançar todas as áreas do compartimento do motor
Medidas: 13, 15, 16, 17, 19mm

 **Características:**
Llave acodada Bihexagonal
Con mango antideslizante para un fácil manejo
Los extremos en ángulo de 45° permiten llegar a todas las zonas del compartimento del motor
Medidas: 13, 15, 16, 17, 19mm

REF	↔	📏	📦
6111	460mm	2,6kg	5x

 Jogo chave luneta curva 10 peças
 Set llaves extractores 10 piezas



 **Medidas:** 12,13,14,15,16,17,18,19mm

 **Medidas:** 12,13,14,15,16,17,18,19mm

REF	↔	📏	📦
6112	400mm	1,3kg	10x

 Kit tirar e colocar correias elásticas universal
 Kit extraer y colocar correas elásticas universal



 Kit tirar e colocar correias elásticas universal
 Kit extraer y colocar correas elásticas universal



	3 cili. PSA, Vauxhall/Opel 1.0L, 1.2L (a partir de 2012).
	Citroën - Berlingo III, Berlingo IV, C-Elysee, C1 II, C3 Aircross, C3 III / C3 Picasso, C3 IV, C4 Cactus, C4 II, C4 Picasso/Grand Picasso, C4 Space Tourer/Grand Space Tourer, C5 Aircross, DS3 / DS3 Cabrio, DS4; Peugeot - 108, 2008, 208, 3008, 301, 308, 5008, 508, Partner III, Partner IV, Rifter; Toyota - Aygo; Vauxhall/Opel- Combo E, Crossland X, Grandland X
	0109-1B, EN-52112-2

	BMW: 118, 120, 318, 325, 330, 335, 520,525, 530, 535, 635, 730, X3, X5 Chrysler: Grand Voyager, Voyager Citroën: C2, C3, C4, Jumper, Relay Fiat: Albea, Doblo, Marea, Multipla, Ducato, Fiorino, Fiorino Qubo Linea, Siena, Stilo, Strada, Lancia Lybra Ford: C-Max, Focus, Mondeo, Tourneo, Transit, Courier, Fiesta, Fusion Iveco: Daily Peugeot: 206, 207, 307, Boxer Volvo: C30, C40, V50
---	--

 **Descrição:** Esta ferramenta serve para remover e instalar as correias elásticas em V da polia tensora sem danificar a nova correia ou pólia

 **Descripción:** La herramienta sirve para desmontar e instalar correas elásticas en V en la polea tensor de la correa sin dañar la nueva correa o la polea

REF	📏	📦
6124	35gr	2x
REF	📏	📦
6120	1,4kg	5x

 Kit reparação roscas M5-M12 131 PCS
 Juego reparación de rosca M5-M12 131 PZS



 Kit reparação roscas
 Juego reparación de rosca



REF 4461



REF 4462



REF 4463

 **Características:**
 (5x) Ferramentas de instalação Inserções de rosca de arame
 (5x) Ferramentas para pinos de M5: 25 PCS
 rutura M6: 25 PCS
 (5x) Brocas de torção M8: 25 PCS
 (5x) Machos M10: 25 PCS
 (1x) Chave hexagonal M12: 10 PCS

 **Características:**
 (5x) Herramientas de instalación Insertos de rosca de alambre
 (5x) Herramientas para pasadores M5: 25 PZS
 de rotura M6: 25 PZS
 (5x) Taladros helicoidales M8: 25 PZS
 (5x) Machos de roscar M10: 25 PZS
 (1x) Llave hexagonal M12: 10 PZS

REF		
4460	920gr	8x

 **Características:**
 (1x) Ferramenta de instalação (1x) Chave hexagonal
 (1x) Ferramenta para pinos de Inserções de rosca de arame:
 rutura 10PCS
 (1x) Broca de torção
 (1x) Machos

 **Características:**
 (1x) Herramienta de instalación (1x) Llave hexagonal
 (1x) Herramienta para pasadores Insertos de rosca de alambre:
 de rotura 10PZS
 (1x) Taladros helicoidales
 (1x) Machos

REF		
4461	M10X1.0	220gr
4462	M14X1.5	480gr
4463	M8X1.0	160gr

 Insertos roscados
 Insertos de hilo de alambre



 Chave correias elásticas BMW N62
 Llave para flexi-correas BMW N62



	BMW N62 4.0, 4.4, 4.8 V8 (02-10), Mini W17 1.4 diesel (03-06)
	BMW
	641040

REF			
4464	M5x0.8	8gr	200x
4465	M6x1.0	9gr	200x
4466	M8x1.25	18gr	200x
4467	M10x1.5	25gr	200x
4468	M12x1.75	35gr	200x
4469	M10x1.0	25gr	200x
4470	M14x1.5	50gr	200x
4471	M8x1.0	18gr	200x

REF		
6116	500gr	1x

 Kit tirar e colocar correias elásticas BMW
 Kit extraer y colocar correas elásticas BMW



	M47T2, M47TU, M57T2, M57TU, N47, N57TU
	BMW

REF		
6121	1kg	1x

 Alinhador / nível para volante
 Alineador / nivel para volante



 **Aplicação:** Adequado para volantes com diâmetro interno 270-340mm
 **Aplicación:** Adequado para volantes con diámetro interno 270-340mm

REF		
8003	250gr	36x

 Chave especial remoção cinto Tesla Model 3/Y
 Llave removedora de cinturón de seguridad para Tesla Model 3/Y



	Tesla Model 3 & Model Y
	1133787-00-A

REF		
6126	62,5gr	48x

 Kit moldar tubos de cobre
 Kit moldeo tubos de cobre



 **Aplicação:** Cobre macio, alumínio, latão e outros tubos
Medidas polegadas: 1/4", 5/16", 3/8", 1/2", 5/8", 3/4" (diâm. exterior)
Medidas métricas: 6, 8, 10, 12, 16, 19mm (diâmetro exterior)
 **Aplicación:** Cobre suave, aluminio, latón y otros tubos
Medidas pulgadas: 1/4", 5/16", 3/8", 1/2", 5/8", 3/4" (diám. exterior)
Medidas métricas: 6, 8, 10, 12, 16, 19mm (diámetro exterior)

REF		
5970	2,7kg	10x

 Jogo alargador de escapes 30-87mm
 Juego alargador de escapes 30-87mm



 **Aplicação:** Para alargar tubos de escape
(1x) Expansor pequeno: 1-1/8" para 1-3/4", (1x) Expansor médio: 1-1/2" para 2-1/2", (1x) Expansor grande: 2-1/8" para 3-1/2"
 **Aplicación:** Para ampliar tubos de escape.
(1x) Pequeño expansor: 1-1/8" para 1-3/4", (1x) Expansor mediano: 1-1/2" para 2-1/2", (1x) Expansor grande: 2-1/8" para 3-1/2"

REF		
7105	3kg	5x

 Separador tubos de escape
 Desmontador tubos de escape



 **Características:**
 Abertura mínima: 34mm
 Abertura máxima: 56mm
 Comprimento parafusos: 170mm

 **Características:**
 Apertura mínima: 34mm
 Apertura máxima: 56mm
 Longitud tornillos: 170mm

REF			
7100	34-56mm	4kg	5x

 Kit ganchos extra longos 6 peças
 Kit de gancho extractor extra largo 6 piezas



 **Aplicação:**
 Adequado para a remoção de orings e vedantes
Conteúdo do kit de ganchos extractores: 90°, reto, em gancho, duplo
 angulo, gancho complexo, gancho 45°

 **Aplicación:**
 Adequado para remover orings y sellos
Contenido del kit de gancho extractor: 90°, recto, enganchado, doble
 angulo, gancho complejo, gancho 45°

REF		
5450	302gr	48x

 Alicete cortar tubos escape com corrente
 Mordaza grip corta tubos con cadena



 **Características:**
 Ideal para cortar tubos de plástico, cobre, alumínio e aço
 Capacidade de corte: Ø85mm
 Adequado para cortar tubos de parede fina com espessura até 2,5mm

 **Características:**
 Ideal para cortar tubos de plástico, cobre, aluminio y acero
 Capacidad de corte: Ø85mm
 Adequado para cortar tubos de pared delgada con espesor hasta
 2,5mm

REF			
6178	160mm	666gr	12x

 Jogo 23 peças para extrair terminais
 Juego 23 piezas para extraer terminales



1 - BMW, Mercedes, Opel, VW/ Audi
 2 - BMW, Jaguar, Mercedes, Porsche, Saab, Seat, Škoda
 3 - BMW, Mercedes, Opel, Porsche, VW/ Audi
 4 - Ford
 5 - BMW, Ford, Mercedes, Opel, Porsche, Seat, Škoda, VW/
 Audi
 6 - BMW, Ford, Jaguar, Mercedes, Opel, Porsche, Saab, Seat
 Škoda, VW/Audi
 7 - Mercedes
 8 - Ford, Jaguar, Mercedes, Opel, Porsche, VW/Audi
 9 - Ford, Mercedes
 10 - Mercedes
 11 - BMW, Ford, Jaguar, Mercedes, Opel, Porsche, Saab,
 Seat Škoda, VW/Audi
 12 - Opel, Renault, Škoda, VW/Audi
 13 - Ford, Mercedes
 14 - Ford, Jaguar, Porsche
 15 - BMW, Ford, Mercedes, Opel, Seat, Škoda, VW/Audi
 16 - BMW, Ford, Jaguar, Mercedes, Opel, Porsche, VW/Audi
 17 - BMW
 18 - Mercedes
 19 - Citroën, Chrysler, Fiat, Ford, Honda, Mazda, Mercedes
 Mitsubishi, Opel, Porsche, Renault, Seat, Toyota, VW/Audi
 20 - Ford
 21 - BMW, Ford, Jaguar, Mercedes, Opel, Porsche, Saab,
 Seat Škoda, VW/Audi
 22 - Honda, Opel, Toyota, VW/Audi
 23 - Opel, VW/Audi

REF		
4637	3kg	2x

FERRAMENTA CARROÇARIA
HERRAMIENTA DE CARROCERIA

05



KROFtools
PROFESSIONAL TOOLS

 FAMÍLIA	PÁGINAS
01 FERRAMENTA MANUAL	11-106
02 ALICATES	109-120
03 BITS E CONJUNTOS	123-134
04 FERRAMENTA ESPECÍFICA	137-214
05 FERRAMENTA CARROÇARIA	217-222
06 REGULAÇÃO E TESTE	225-246
07 FERRAMENTA MOTOR	249-276
08 KITS SINCRONIZAÇÃO	279-350
09 FERRAMENTA ELÉTRICA	353-362
10 FERRAMENTA PNEUMÁTICA	365-378
11 FERRAMENTA HIDRÁULICA	381-404
12 FERRAMENTA LUBRIFICAÇÃO	407-414
13 EQUIPAMENTO GARAGEM	417-502
RT ROUPA DE TRABALHO	505-508
MR MERCHANDISING	511-514
EP EXPOSITORES	517-524
LR LOCALIZAÇÃO REFERÊNCIAS	527-538

 FAMILIA	PÁGINAS
01 HERRAMIENTA MANUAL	11-106
02 ALICATES	109-120
03 PUNTAS Y CONJUNTOS	123-134
04 HERRAMIENTA ESPECÍFICA	137-214
05 HERRAMIENTA DE CARROCERIA	217-222
06 REGULACIÓN Y PRUEBAS	225-246
07 HERRAMIENTA PARA MOTOR	249-276
08 KIT CALADO	279-350
09 HERRAMIENTA ELÉCTRICA	353-362
10 HERRAMIENTA NEUMÁTICA	365-378
11 HERRAMIENTA HIDRÁULICA	381-404
12 HERRAMIENTA LUBRICACIÓN	407-414
13 EQUIPAMENTO PARA TALLER	417-502
RT ROPA DE TRABAJO	505-508
MR MERCHANDISING	511-514
EP EXPOSITORES	517-524
LR LOCALIZACIÓN REFERENCIAS	527-538



 Alicate saca molas
 Alicate sacagrapas tapizado



Descrição:
Remove o forro da porta e outros revestimentos
A ponta de 2 fases permite fácil acesso às cabeças dos cliques para evitar que deslize
Punho com mola para uma melhor alavancagem

Descripción:
Retira la tapicería de la puerta y otros revestimientos
La punta de 2 pasos permite un fácil acceso a los cabezales de los clips para evitar resbalones
Mango con resorte para un mejor apalancamiento

REF	⊖	↔	⚖	📄
6137	7.5mm	230mm	250gr	36x

 Jogo 6 peças para remover painéis
 Juego 6 piezas para quitar paneles



Descrição:
Indicado para remoção dos painéis interiores de plástico do veículo sem os danificar

Descripción:
Indicado para quitar los paneles de plástico dentro del vehículo sin dañarlos

REF	⚖	📄
2417	250gr	24x

 Sacca molas de portas
 Sacagrapas tapiceria



Descrição:
Para remover rapidamente a forra das portas e as molas dos estofos
Reduz os danos nos painéis e a perda de cliques
Pode ser usado em quase todas as marcas

Descripción:
Para quitar rápidamente los paneles de puertas y clips de tapicería
Reduce el daño a los paneles la pérdida de clips
Se puede usar en casi todas las marcas

REF	↔	⚖	📄
5409	240mm	181gr	80x

 Sacca molas de portas nº2
 Sacagrapas tapiceria nº2



Descrição:
Remove as molas de plástico dos painéis das portas

Descripción:
Retire los resortes de plástico de los paneles de la puerta

REF	↔	⚖	📄
5720	275mm	187gr	80x

 Rebitadora e 40 rebites plásticos
 Remachadora y 40 remaches plásticos



Composição:
(10x) Rebites 5.0x15.8mm, (10x) Rebites 5.0x17.2mm
(10x) Rebites 6.3x25.2mm, (10x) Rebites 6.6x17.3mm

Composición:
(10x) Remaches 5.0x15.8mm, (10x) Remaches 5.0x17.2mm
(10x) Remaches 6.3x25.2mm, (10x) remaches 6.6x17.3mm

REF	↔	⚖	📄
7541	170mm	500gr	20x

 Rebites plásticos 100pcs
 Remaches plásticos 100pzs



Descrição: Todos os rebites vem em embalagens de 100x unid

Descripción: Todos los remaches vienen en paquetes de 100x unid

REF	⊖	⚖	📄
7545	6.3x25.2mm	153gr	100x
7546	5.0x15.8mm	90gr	100x
7547	6.0x17.2mm	190gr	100x
7548	5.0x17.2mm	110gr	100x

-  Chave para desmontar puxador da porta
 Llave para desmantelamiento manija de la puerta



	VW
	T10389

REF	↔	📏	📦
5408	260mm	112gr	40x

-  Jogo de ventosas para colocar para-brisas
 Ventosas cristales ventanillas



-  **Descrição:** Capacidade máxima da ventosa: 80Kg (individual)
 Peso máximo suporte da cinta com sistema de bloqueio: 200kg
 **Descripción:** Capacidad máxima de la ventosa: 80Kg (individual)
 Peso máximo soporte pela cinta con sistema de bloqueio: 200kg

REF	↔	↔	📏	📦
5401	115mm	410mm	2,5kg	5x

-  Saca cavilha de portas
 Juego extraer pasadores puertas



-  **Medidas:** 3x90, 5x90, 5x105, 5.5x90

-  **Medidas:** 3x90, 5x90, 5x105, 5.5x90

REF	📏	📦
4179	300gr	1x

-  Agulha para fio de cortar para-brisas
 Lezna para alambre



REF	↔	📏	📦
5392	300mm	68gr	1x

-  Saca limpa para-brisas com braços reguláveis
 Extractor brazos limpiaparabrisas



-  **Descrição:**
 Ajustável, compacto, leve e fácil de usar
 Impede de danificar o braço do limpa para-brisas
 Eixo especial na travessa que encaixa no pára-brisas

-  **Descripción:**
 Ajustable, compacto, ligero y fácil de usar
 Evita dañar el brazo del limpiaparabrisas
 Eje especial en el travesaño que encaja en el limpiaparabrisas

REF	↔	📏	📦
7150	50mm	222gr	36x

-  Disco de borracha para adesivos
 Disco de goma



-  **Características:**
 Adequado para berbequins eléctricos
 Diámetro: 90mm. Diámetro eixo: 6.35mm. Máx. 4000rpm

-  **Características:**
 Apto para taladros eléctricos
 Diámetro: 90mm. Diámetro del eje: 6.35mm. Máx. 4000rpm

REF	📏	📏	📦
5390	(1x)	180gr	100x
5391	(5x)	700gr	1x

 Punho longo para puxar fio
 Palanca para lunas



REF	↔	📏	📦
5396	240mm	154gr	1x

 Rolo de arame 50m
 Rollo de cable de lunas 50m



 **Características:**
Material: Aço inoxidável
Diâmetro: 0.7mm
Comprimento: 50m

 **Características:**
Material: Acero inoxidable
Diámetro: 0.7mm
Longitud: 50m

REF	↔	📏	📦
7491	50m	283gr	100x

 Kit descolar vidro 7 peças
 Kit despegar lunas 7 piezas



 **Descrição:** Kit de ferramentas completo para a remoção de vidros/borracha

Composição: (1x) Fio de corte; (2x) Punhos puxar fio (1x) Ferramenta remoção para-brisas; (1x) Ferramenta alimentação de arame (1x) Extrator guarnição; (1x) Ferramenta remoção molde para-brisas

 **Descripción:** Kit de herramientas completo para quitar ventanas/goma pegadas

Composición: (1x) Alambre de corte; (2x) Tiradores de alambre (1x) Herramienta de extracción de parabrisas; (1x) Herramienta de alimentación de alambre; (1x) Extractor de recortes; (1x) Herramienta de eliminación de moho de parabrisas

REF	📏	📦
5400	1,1kg	10x

 Instalador e removedor freios cavaleiros
 Util extraer precintos manivelas



 **Descrição:**
Um punho com 4 lâminas: 6mm, 7mm, 8mm, 9mm
Remove e instala de forma segura os freios sem os danificar
Uma extremidade instala a outra remove

 **Descripción:**
Un mango con 4 cuchillas: 6mm, 7mm, 8mm, 9mm
Para retirar o instalar de forma segura los precintos sin dañar
Una extremidad instala la otra extrae

REF	⊕	📏	📦
0225	6,7,8,9mm	234gr	1x

 Jogo de 4 raspadores
 Juego de 4 raspadores

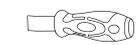

2x		94x31mm
2x		43x20mm

REF	📏	📦
5380	583gr	24x

 **Jogo 12 peças para retirar airbag**
 **Juego 12 piezas para retirar airbag**



 **Descrição:**

Este kit 12 peças abrange praticamente todos os carros modernos, incluindo: Volkswagen, Audi, Škoda, Ford, Opel, BMW, Mercedes, etc. Remove airbags do volante sem danos. Contém lâminas com ângulo, para retirar a superfície plástica do airbag.

Composição:

- (1x) Lâmina 105x95mm: VW
- (1x) Chave T30H: Audi, BMW, Mercedes, Opel
- (1x) Chave T25H: BMW
- (1x) Chave hex. 5mm: Audi
- (2x) Extratores: VW Passat B5, Polo, Lupo, Audi A4, A6, Škoda Superb
- (1x) Extrator: VW, Audi, Seat, Škoda, BMW, Mercedes
- (1x) Ferramenta universal: VW, Audi, Seat, Škoda, BMW, Mercedes
- (1x) Chave T30: Audi, Opel, Renault, VW
- (1x) Chave T25: BMW
- (2x) Lâminas: VW Golf 4, New Beetle, Seat, Škoda Fabia, Octavia

 **Descripción:**

Este kit incluye 12 piezas de casi todos los coches modernos, entre ellos: Volkswagen, Audi, Škoda, Ford, Opel, BMW, Mercedes, etc. Retira los airbags del volante sin dañarlos. Contiene cuchillas en ángulo para quitar la superficie de plástico del airbag.

Composición:

- (1x) Cuchilla 105x95mm: VW
- (1x) Llave T30H: Audi, BMW, Mercedes, Opel
- (1x) Llave T25H: BMW
- (1x) Llave hex. 5mm: Audi
- (2x) Extractores: VW Passat B5, Polo, Lupo, Audi A4, A6, Škoda Superb
- (1x) Extrator: VW, Audi, Seat, Škoda, BMW, Mercedes
- (1x) Herramienta universal: VW, Audi, Seat, Škoda, BMW, Mercedes
- (1x) Llave T30: Audi, Opel, Renault, VW
- (1x) Chave T25: BMW
- (2x) Cuchillas: VW Golf 4, New Beetle, Seat, Škoda Fabia, Octavia

REF		
2420	1,4kg	5x

 **Chave retirar canhão ignição mercedes**
 **Llave para extraer cañón ignición mercedes**



	Mercedes W129, W140, W202, W210, W220
---	---------------------------------------

REF				
2425	36/40mm	80mm	80gr	1x

 **Kit remover rádio CD 52 peças**
 **Set quitar radio CD 52 piezas**



 **Composição:**

- (2x) Extracção do rádio ganchos em U (Ford, VAG, Grundig, Blaupunkt)
- (1x) Chave pentagonal especial (BMW)
- (4x) Ferramenta para extracção do rádio (VW, Audi, Becker, Mercedes)
- (2x) Ferramenta para extracção do rádio (Mercedes-Benz, Porsche, Becker)
- (2x) Ferramenta para extracção do rádio (Volkswagen)
- (1x) Chave allen de PC (BMW, Opel)
- (2x) Ferramenta para extracção do rádio (Becker, Nieuwe typen)
- (2x) Ferramenta para extracção do rádio (Skoda, Nieuwe typen)
- (2x) Extracção do rádio 2 Pcs ganchos em U (Blaupunkt, Nieuwe typen)
- (2x) Ferramenta para extracção do rádio (Fiat)
- (2x) Ferramenta extração rádio U (Opel)
- (6x) Ferramenta de remoção do rádio (Mercedes-Benz, BMW)
- (2x) Ferramenta para extracção do rádio (II Kenwood - 1998-2001)
- (2x) Ferramenta para extracção do rádio (Sony II, <2002)
- (2x) Ferramenta para extracção do rádio (IV Kenwood, <2002)
- (2x) Ferramenta para extracção do rádio (Pioneer, JVC)
- (2x) Ferramenta para extracção do rádio (Sony, 2001<)
- (2x) Ferramenta para extracção do rádio (Panasonic)
- (2x) Ferramenta para extracção do rádio (I Kenwood, 1998<)
- (2x) Ferramenta para extracção do rádio (Máscara Kenwood)
- (2x) Ferramenta para extracção do rádio (Clarion, novo tipo)
- (2x) Ferramenta para extracção do rádio (Clarion, tipo antigo)
- (2x) Ferramenta para extracção do rádio (Panasonic 2006)
- (2x) Ferramenta para extracção do rádio (Sony IDIC 2005)

 **Composición:**

- (2x) Extracción de la radio U-gancho (Ford, VAG, Grundig, Blaupunkt)
- (1x) Llave pentagonal especial (BMW)
- (4x) Herramienta de extracción de radio (VW, Audi, Becker, Mercedes)
- (2x) Herramienta de extracción de radio (Mercedes-Benz, Porsche, Becker)
- (2x) Herramienta de eliminación de radio (Volkswagen)
- (1x) La clave de allen de 1 PC (BMW, Opel)
- (2x) Herramienta de eliminación de radio (Becker, Nieuwe typen)
- (2x) Herramienta de eliminación de radio (Skoda, Nieuwe typen)
- (2x) Extracción de la radio U-gancho (Blaupunkt, Nieuwe typen)
- (2x) Herramienta de extracción de radio (Fiat)
- (2x) Herramienta de extracción de radio U (Opel)
- (6x) Herramienta de extracción de radio (Mercedes-Benz, BMW)
- (2x) Herramienta de extracción de radio (Kenwood II (1998-2001)
- (2x) Herramienta de extracción de radio (Sony II <2002)
- (2x) Herramienta de extracción de radio (Kenwood IV, <2002)
- (2x) Herramienta de extracción (Pioneer JVC)
- (2x) Herramienta de extracción (Sony, 2001<)
- (2x) Herramienta de extracción (Panasonic)
- (2x) Herramienta de extracción de radio (radio Kenwood I, 1998<)
- (2x) Herramienta de extracción de radio Kenwood (máscara)
- (2x) Herramienta de extracción de radio (Clarion, nuevo tipo)
- (2x) Herramienta de extracción de radio (Clarion, antigua)
- (2x) Herramienta de extracción de radio (Panasonic (2006)
- (2x) Herramienta de extracción de radio Sony IDIC (2005)

REF		
2430	1,3kg	5x

Extrator de airbag Opel
Extractor de airbag Opel



Opel Insignia, Astra (2008)

REF

2421



161gr



1x

Removedor parafusos por indução 500-900W
Extractor de tornillos por inducción 500-900W

Máquina tira-mossas por indução 800W
Herramienta abolladuras por inducción 800W



Características:
 Voltagem entrada: 220V 50/60Hz
 Corrente entrada: 4A
 Potência entrada: 500-900W
 Voltagem saída: 40V
 Corrente saída: 180A
 Resistências: (3x) 18, 22, 28mm (diâmetro), 200mm (comprimento)
 (1x) 1m flexível (comprimento)

Características:
 Voltagem entrada: 220-240V
 Corrente entrada: 3.6A
 Potência saída: 800W
 Voltagem entrada: 300V
 Corrente saída: 14A
 Cabo principal: 1.8m
 Cabo energia: 1.5m

Características:
 Voltaje entrada: 220V 50/60Hz
 Corriente entrada: 4A
 Potencia entrada: 500-900W
 Voltaje salida: 40V
 Corriente salida: 180A
 Resistencias: (3x) 18, 22, 28mm (diámetro), 200mm (longitud)
 (1x) 1m flexible (longitud)

Características:
 Voltaje de entrada: 220-240V
 Corriente de entrada 3.6A
 Potencia de salida 800W
 Tensión de salida 300V
 Corriente de salida: 14A
 Cable principal: 1.8m
 Cable de alimentación: 1.5m

REF

2491



1,6kg



5x

REF

2490



2,7kg



5x

Alicate pressão com martelo deslizante
Mordaza grip con martillo deslizante

Kit martelo deslizante tira-mossas 5 peças
Kit martillo deslizante quita abolladuras 5 piezas



Aplicações:
 Superfícies de madeira, para extração de pregos e pinos
Inclui:
 (1x) Martelo deslizante (desmontável)
 (1x) Alicate pressão 10"

Aplicações:
 Martelo deslizante de função dupla para serviço pesado, montado em eixo de aço robusto com pega de borracha
 Retira entalhes da carroceria do veículo e remove rolamentos difíceis de deslocar de eixos e cubos
Inclui: Cone nariz, Parafusos extrator, Gancho L, Martelo de ferro fundido

Aplicaciones:
 Superfícies de madera, para extraer clavos y alfileres
Incluye:
 (1x) Martillo deslizante (desmontable)
 (1x) Alicates de 10"

Aplicación: Martillo deslizante de doble función para servicio pesado, montado en eje de acero robusto con grip de vinilo
 Retira las muescas de la carrocería del vehículo y quita rodamientos difíciles de desplazamiento de ejes y bujes
Incluye: Cono nariz, Tornillos extractor, Gancho L, Martillo de hierro fundido

REF

2493



2kg



6x

REF

2492



1,6kg



12x

 **Macaco chapeiro 10T**
 **Kit hidráulico de carroçero 10T**



 **Características:**
Capacidade: 10 Toneladas
Altura Mínima: 322mm/12.68"
Curso: 130mm/5.12"

 **Características:**
Capacidad: 10 Toneladas
Altura Mínima: 322mm/12.68"
Curso: 130mm/5.12"

REF		
4841	30kg	1x

 **Kit almofadas infláveis 5 peças**
 **Kit bolsillas hinchables 5 piezas**



 **Aplicação:**
Uso em aberturas de emergência
Para alargar caixilhos das portas
Bomba manual com válvula

 **Aplicación:**
Uso en aberturas de emergencia
Para ampliar los marcos de las puertas
Bomba manual con valvula

REF		
5290	350gr	40x

 **Kit raspadores 3pcs**
 **Juego raspadores 3 piezas**



 **Descrição:**
Com pega macia para um trabalho seguro e sem fadiga
Superfície reafiável
Aço CR-VI temperado

 **Descripción:**
Con empuñadura suave para un trabajo seguro y sin fatiga
Superficie reafilable
Acero CR-VI endurecido

REF		
5379	1,1kg	10x

 **Kit restauração faróis**
 **Kit restaurador de faros**



2x		P800
2x		P1200
2x		P2000
2x		 UV 3.0ml
1x		 85gr
1x		
1x		
1x		 M10

 **Aplicação:** Este kit de restauração de faróis é projetado para eliminar os casos de degradação, amarelecimento, oxidação e arranhões dos seus faróis
O kit inclui um suporte com adaptador que permite o polimento do faro para restaurar a lente mais nublada

 A pasta de polir e o líquido protecção UV tem prazo de validade de 3 anos, relativamente ao lote da embalagem, enquanto fechado
Assim que a embalagem for aberta, esta tem um prazo de validade de 1 ano

 **Aplicación:** Este kit de restauración de faros está diseñado para eliminar los casos de degradación, amarillamiento, oxidación y arañazos de sus faros
El kit incluye un soporte con adaptador que permite pulir el faro para restaurar la lente más nublada

 La pasta de pulido y el líquido de protección UV tienen una validez de 3 años en el paquete cuando cerrado
Una vez que el paquete se ha abierto, tiene una vida útil de 1 año

REF		
2495	247gr	36x

REGULAÇÃO E TESTE
REGULACIÓN Y PRUEBAS

06



 FAMÍLIA	PÁGINAS
01 FERRAMENTA MANUAL	11-106
02 ALICATES	109-120
03 BITS E CONJUNTOS	123-134
04 FERRAMENTA ESPECÍFICA	137-214
05 FERRAMENTA CARROÇARIA	217-222
06 REGULAÇÃO E TESTE	225-246
07 FERRAMENTA MOTOR	249-276
08 KITS SINCRONIZAÇÃO	279-350
09 FERRAMENTA ELÉTRICA	353-362
10 FERRAMENTA PNEUMÁTICA	365-378
11 FERRAMENTA HIDRÁULICA	381-404
12 FERRAMENTA LUBRIFICAÇÃO	407-414
13 EQUIPAMENTO GARAGEM	417-502
RT ROUPA DE TRABALHO	505-508
MR MERCHANDISING	511-514
EP EXPOSITORES	517-524
LR LOCALIZAÇÃO REFERÊNCIAS	527-538

 FAMILIA	PÁGINAS
01 HERRAMIENTA MANUAL	11-106
02 ALICATES	109-120
03 PUNTAS Y CONJUNTOS	123-134
04 HERRAMIENTA ESPECÍFICA	137-214
05 HERRAMIENTA DE CARROCERIA	217-222
06 REGULACIÓN Y PRUEBAS	225-246
07 HERRAMIENTA PARA MOTOR	249-276
08 KIT CALADO	279-350
09 HERRAMIENTA ELÉCTRICA	353-362
10 HERRAMIENTA NEUMÁTICA	365-378
11 HERRAMIENTA HIDRÁULICA	381-404
12 HERRAMIENTA LUBRICACIÓN	407-414
13 EQUIPAMENTO PARA TALLER	417-502
RT ROPA DE TRABAJO	505-508
MR MERCHANDISING	511-514
EP EXPOSITORES	517-524
LR LOCALIZACIÓN REFERENCIAS	527-538



 **Kit compressão motor diesel**
 **Juego compresímetro motor diesel**



Características:
Verifica a compressão dos motores nas condições de arranque
Manómetro 80mm de dupla escala: 0-70BAR e 0-1000psi
Mangueira flexível: 355mm

Características:
Comprueba la compresión de los motores en las condiciones de arranque
Manómetro 80mm de doble escala: 0-70BAR y 0-1000psi
Manguera flexible: 355mm

REF			
8100	0-70BAR	0-1000psi	4kg 2x

 **Jogo compressímetro diesel**
 **Juego compresímetro diesel**



Características: Jogo para verificar a perda de compressão em carros, carrinhas e pequenos barcos com motores a diesel
Composição: Adaptador de vela - 91mm M10×1, 119mm M10×1, 135mm M10×1.25, 118mm, M02×1.5, 113mm M10×1, 102mm M8×1, 83mm M10×1, 67mm M10×125, 51mm M12×125
Adaptador do injetor - 88mm M24×1.5, 75mm M22×1.5, 63mm, M24×2,75mm M20×15, Adaptador de parafuso - 160mm M18×15
Medidor com mostrador - 340mm, Engate, Válvula de purga

Características: Juego para comprobar la pérdida de compresión en los coches, furgonetas y pequeños barcos con motores diesel
Composición: Adaptador de bujía - 91mm M10×1, 119mm M10×1, 135mm M10×1.25, 118mm, M02×1.5, 113mm M10×1, 102mm M8×1, 83mm M10×1, 67mm M10×125, 51mm M12×125
Adaptador inyector - 88mm M24×1.5, 75mm M22×1.5, 63mm, M24×2,75mm M20×15, Adaptador de tornillo - 160mm M18×15
Reloj comparador - 340mm, Conexión, Válvula de purga

REF			
8102	0-70BAR	0-1000psi	4,8kg 2x

 **Teste compressão injetores diesel para camião**
 **Juego compresímetro inyector diesel para camión**



Composição:
(1x) Manómetro (0-1000psi), (1x) Válvula respiro, (1x) Mangueira, (1x) Engate rápido 1/8" NPT, (3x) Engate rápido 7/16"20" (F), (3x) Adap. M12x1,25(M) - 7/16"-20 (M), (2x) Adap. M12x1,25 (F) - M18x1,5 (M), (1x) Adap. curto M10x1,25 (1x) Adap. longo M10x1.25, (1x) Engate rápido macho ZGI 1/8" (M) (1x) Adap. ZGI 1/8" (F) - M24x2(M), (1x) Manga adaptadora (1x) Engate rápido com rolamento, (1x) Porca bloqueio mangueira 1/2" - 19 (1x) Conector 7/16"-20(M)-7/16"-20(F) 90°, (1x) Adap. ZGI 1/8" (M) - M24x15(M) (1x) Adap. M10x1(M), (1x) Anilha cobre

Composición:
(1x) Manómetro (0-1000 psi), (1x) Válvula de purga, (1x) Manguera, (1x) Acoplamiento rápido 1/8" NPT (3x) Acoplamiento rápido 7/16"20" (H), (3x) Adap. M12x1,25(M) - 7/16"-20(M), (2x) Adap. M12x1,25 (H) - M18x1,5 (M), (1x) Adapt. corto M10x1,25 (1x) Adapt. largo M10x1,25, (1x) Acoplamiento rápido ZGI macho 1/8" (M) (1x) Adap. ZGI 1/8" (H) - M24x2(M), (1x) Manga adapt. (1x) Acoplamiento rápido con cojinete, (1x) Tuerca bloqueio mangueira 1/2" - 19 (1x) Conector 7/16"-20(M)-7/16"-20(H) 90°, (1x) Adap. ZGI 1/8" (M) - M24x15(M). (1x) Adap. M10x1(M), (1x) Arandela de cobre

REF			
8101	0-70BAR	0-1000psi	3,2kg 2x

 **Teste corrente para injetores 11 peças**
 **Comprobador corriente inyector 11 piezas**



Descrição:
Testa de forma rápida e fácil os sistemas de injeção electrónica de combustível

O conjunto inclui:
8 luzes Noid para testar GM PFI, FORD TBI, GEO TBI, BOSCH PFI, GM TBI, GM SCPI, GM MULTEC 2 e BOSCH 2
Duas aplicações de luz de teste de sinal IAC: GM 1987 e GM 1982
Extensão de fibra óptica Noid Light

Descripción:
Prueba rápida y fácilmente los sistemas electrónicos de inyección de combustible

El juego incluye:
8 luces Noid para probar GM PFI, FORD TBI, GEO TBI, BOSCH PFI, GM TBI, GM SCPI, GM MULTEC 2 y BOSCH 2
Dos aplicaciones de luz de prueba de señal IAC: GM 1987 y GM 1982
Una extensión Noid Light de fibra óptica

REF		
8115	440gr	20x

 Jogo compressímetro diesel master com adaptadores
 Juego compresímetro diesel master con adaptadores



Manómetro



REF 8103M



Alfa Romeo, Audi, BMW, Chrysler, Citroën, Daewoo, Daihatsu, Fiat, Ford, FSO, Honda, Hyundai, Isuzu, Jeep, Kia, Lada, Lancia, Land Rover, LDV, Mazda, Mercedes, MG, Mitsubishi, Nissan, Opel, Peugeot, Renault, Rover Saab, Seat, Škoda, Ssangyong, Suzuki, Toyota, VAG, VW, Volvo

-  **Descrição:** Velas encandescentes: 10, 12, 14, 18mm
Adaptador de injetores: M20, M22, M24
Injetores: Ford Stanadyne e injetores de braçadeira
-  **Descripción:** Calentadores: 10, 12, 14, 18mm
Adaptador de inyectoros: M20, M22, M24
Inyectoros: Ford Stanadyne y inyectoros de abrazadera

REF

8103



0-40BAR



4,8kg



2x

 Jogo compressímetro e teste fugas diesel/gasolina
 Juego compresímetro y comprobador fugas diesel/gasolina



-  **Descrição:**
 Adequado para a maioria dos motores a gasolina e HDi modernos, TDCi, injetores de bomba e motores diesel mais antigos
 Teste de pressão e compressão até 50BAR (725 PSI) possível
 Engate rápido reto ou angular, todos os medidores com proteção de borracha
 Adequado para a maioria dos carros, camiões, autocarros, motores agrícolas e marítimos

Composição:

Adaptadores de velas incandescentes para as seguintes marcas: Alfa, BMW, Chrysler, Daewoo, Fiat, Ford, Hyundai, Izusu, Land Rover, Mazda, Mercedes-Benz, Mitsubishi, Nissan, Opel, PSA, Renault, Saab, Suzuki, Toyota, VAG, Vauxhall e Volvo
 Adapt. injetores M20, M22, M24 e injetores Stanadyne para Ford
 Adapt. de vela de ignição M10, M12, M14 e M18
 Manómetro de pressão adicional para teste de queda de pressão

**Descripción:**

Adecuado para la mayoría de los motores de gasolina y los modernos HDi, TDCi, inyectoros de bomba y motores diesel más antiguos
 Posibilidad de realizar pruebas de presión de compresión de hasta 50BAR (725 PSI)
 Acoplamiento rápido en versión recta o acodada, todos los manómetros con protección de goma
 Adecuados para la mayoría de los coches, camiones, autobuses, motores agrícolas y marinos

Composición:

Adaptadores de calentadores para las siguientes marcas: Alfa, BMW, Chrysler, Daewoo, Fiat, Ford, Hyundai, Izusu, Land Rover, Mazda, Mercedes-Benz, Mitsubishi, Nissan, Opel, PSA, Renault, Saab, Suzuki, Toyota, VAG, Vauxhall y Volvo
 Adapt. inyectoros M20, M22, M24 e inyectoros Stanadyne para Ford
 Adaptadores de bujías M10, M12, M14 y M18
 Manómetro adicional para la prueba de caída de presión

REF

8106



50BAR



5,85kg



2x

Kit adaptadores para testes de compressão e fuga 30 peças
Kit adaptadores para pruebas de compresión y fugas 30 piezas



Parte / Descrição / Comprimento da rosca / Comprimento do eixo inferior
Comprimento exterior do eixo inferior:

- 1 Adaptador de velas de incandescência M12 x 1,25 12mm 8mm
- 2 Adaptador de velas de incandescência M10 x 1,25 12mm 8mm
- 3 Adaptador de velas de incandescência M12 x 1,25 11mm 41mm
- 4 Adaptador de velas de incandescência M10 x 1,25 22.5mm 23.5mm
- 5 Adaptador de velas de incandescência M10 x 1,25 18.5mm 10.5mm
- 6 Adaptador de velas de incandescência M10 x 1,25 28mm 16mm
- 7 Adaptador de velas de incandescência M10 x 1,25 23mm 9.5mm
- 8 Adaptador de velas de incandescência M10 x 1,25 28mm 55mm 3mm
- 9 Adaptador de velas de incandescência M10 x 1,25 26mm 59mm
- 10 Adaptador de velas de incandescência M10 x 1,25 29mm 73mm
- 11 Adaptador de velas de incandescência M10 x 1,25 15mm 27mm
- 12 Adaptador de vela de incandescência M10 x 1,00 12mm 23mm
- 13 Adaptador de vela de incandescência M10 x 1,00 12mm 31mm
- 14 Adaptador de vela de ignição M14 x 1,25 Comprimento da mangueira: 250mm
- 15 Adaptador de vela de incandescência M10 x 1,00 12mm 14mm
- 16 Adaptador de vela de incandescência M10 x 1,00 10mm 59mm
- 17 Adaptador de vela de incandescência M10 x 1,00 12mm 47mm
- 18 Adaptador de velas de incandescência M10 x 1,00 12mm 42mm
- 19 Adaptador de vela de incandescência M10 x 1,00 10mm 64mm 5mm
- 20 Adaptador de vela de incandescência M10 x 1,00 12mm 57mm 5mm
- 21 Adaptador de vela de incandescência M8 x 1,00 12mm 52mm
- 22 Adaptador de 38 mm com punho serrilhado
- 23 Peça angular com acoplador rápido
- 24 Adaptador de vela de ignição M10 x 1,00
- 25 Adaptador de vela de ignição M12 x 1,25
- 26 Adaptador de vela de incandescência (sem rosca) sem rosca 59mm
- 27 Adaptador de vela de ignição M18 x 1,50
- 28 Kit de acessórios Junta, O-Ring, núcleo da válvula

Parte / Descripción / Longitud de rosca / Longitud del eje inferior / Longitud exterior del eje inferior:

- 1 Adaptador de bujía incandescente M12 x 1,25 12mm 8mm
- 2 Adaptador de bujía incandescente M10 x 1,25 12mm 8mm
- 3 Adaptador de bujía incandescente M12 x 1,25 11mm 41mm
- 4 Adaptador de bujía incandescente M10 x 1,25 22.5mm 23.5mm
- 5 Adaptador de bujía incandescente M10 x 1,25 18.5mm 10.5mm
- 6 Adaptador de bujía incandescente M10 x 1,25 28mm 16mm
- 7 Adaptador de bujía incandescente M10 x 1,25 23mm 9.5mm
- 8 Adaptador de bujía incandescente M10 x 1,25 28mm 55mm 3mm
- 9 Adaptador de bujía incandescente M10 x 1,25 26mm 59mm
- 10 Adaptador de bujía incandescente M10 x 1,25 29mm 73mm
- 11 Adaptador de bujía incandescente M10 x 1,25 15mm 27mm
- 12 Adaptador de bujía incandescente M10 x 1,00 12mm 23mm
- 13 Adaptador de bujía de incandescencia M10 x 1,00 12mm 31mm
- 14 Adaptador de bujía de encendido M14 x 1,25 Longitud de la manguera: 250mm
- 15 Adaptador de bujía de incandescencia M10 x 1,00 12mm 14mm
- 16 Adaptador de bujía de incandescencia M10 x 1,00 10mm 59mm
- 17 Adaptador de bujía de incandescencia M10 x 1,00 12mm 47mm
- 18 Adaptador de bujía de incandescencia M10 x 1,00 12mm 42mm
- 19 Adaptador de bujía incandescente M10 x 1,00 10mm 64mm 5mm
- 20 Adaptador de bujía incandescente M10 x 1,00 12mm 57mm 5mm
- 21 Adaptador de bujía incandescente M8 x 1,00 12mm 52mm
- 22 Adaptador de 38 mm con mango moleteado
- 23 Pieza angular con acoplamiento rápido
- 24 Adaptador de bujía de encendido M10 x 1,00
- 25 Adaptador de bujía de encendido M12 x 1,25
- 26 Adaptador de bujía de incandescencia (sin rosca) sin rosca 59mm
- 27 Adaptador para bujías de encendido M18 x 1,50
- 28 Juego de accesorios Junta, junta tórica, núcleo de válvula



Alfa Romeo, Audi, BMW, Chrysler, Citroën, Daewoo, Fiat, Ford, Honda, Hyundai, Isuzu, Jeep, Kia, Lada, Lancia, Land Rover, LDV, Mazda, Mercedes, Mitsubishi, Nissan, Opel, Peugeot, Range Rover, Renault, Rover, Saab, Seat, Škoda, Suzuki, Toyota, Opel, Volvo, VW

Descrição: Para medições de perda de pressão e compressão em motores a diesel e gasolina
Inclui adaptadores de rosca para velas de incandescência e velas de ignição

Descripción: Para medir la pérdida de presión y la compresión en motores diésel y de gasolina
Incluye adaptadores para roscas de bujías y bujías

REF

8113



1,3kg



10x

 **Kit bomba vácuo e pressão**
 **Kit bomba presión y vacío**

 **Descrição:**

Adequado para diagnóstico de desempenho do motor, manutenção de sistemas de ar condicionado, purga de travões, transferência de fluidos e reparação de para-brisas

A bomba de vácuo também é adequada para necessidades diárias de selagem a vácuo

 **Descripción:**

Adequado para el diagnóstico del rendimiento del motor, mantenimiento de sistemas de aire acondicionado, purga de frenos, transferencia de fluidos y reparación de parabrisas.

La bomba de vacío también es adecuada para necesidades diarias de sellado al vacío

REF



874gr



10x

 **Kit manómetro teste injeção gasolina mono multi**
 **Kit manómetro prueba inyección gasolina mono multi**

 **Descrição:**

Kit completo de mangueiras, adaptadores e acessórios para testar a pressão nos sistemas modernos de injeção de combustível de gasolina. Fornecido com manómetro único de alta pressão com proteção de borracha, leitura 0-140psi e 0-10BAR

 **Descripción:**

Kit completo de mangueras, adaptadores y accesorios para comprobar la presión en los modernos sistemas de inyección de gasolina. Se suministra con un único manómetro de alta presión con protección de goma, con lectura de 0-140psi y 0-10BAR

REF



0-10BAR



4kg



5x

 **Teste de injetores common rail com 24 adaptadores**
 **Medidor de inyectores common rail con 24 adaptadores**

Capa / Capa



REF 8111A

Proveta / Probeta



REF 8114P

Copo / Vaso



REF 8111C

 **Descrição:**

Teste de injetores com 24 adaptadores adequados para o uso em injetores diesel Bosch, Denso, Siemens e Delphi

 **Descripción:**

Teste de inyectores con 24 adaptadores adecuados para el uso en inyectores diesel Bosch, Denso, Siemens y Delphi

REF



2,9kg



2x

 **Teste common rail alta pressão**
 **Medidor common rail alta presión**

 **Descrição:**

Teste analógico de alta pressão com várias linhas de conexão. Serve para verificar a bomba de alta pressão / sistema de alta pressão durante o arranque ou marcha. A escala do medidor lê de 0-2000BAR

O teste tem uma válvula de descarga de pressão embutida que limita a pressão máxima a aproximadamente 1500BAR para evitar danos no teste ou no veículo

O teste é fornecido com dois conjuntos de mangueiras ultra flexíveis, permitindo a conexão em áreas de difícil acesso

 **Descripción:**

Prueba analógica de alta presión con múltiples líneas de conexión. Sirve para comprobar la bomba de alta presión / sistema de alta presión al arranque o en funcionamiento

La prueba tiene una válvula de alivio de presión incorporada que limita la presión máxima a aproximadamente 1500 BAR para evitar daños a la prueba o al vehículo

La prueba se suministra con dos juegos de mangueras ultra flexibles, que permiten la conexión en zonas de difícil acceso

REF



2000BAR



4,25kg



2x

 **Teste compressão para motores gasolina básico**
 **Juego compresímetro para motores gasolina básico**



 **Composição:**
(1x) Mangueira de borracha: 330mm
(1x) Adaptador: 14/18mm

 **Composición:**
(1x) Manguera de goma: 330mm
(1x) Adaptador: 14/18mm

REF			
1409	3-20BAR	1,14kg	5x

 **Kit sangrar diesel circuito baixa pressão**
 **Juego purgar diesel circuito de baja presión**

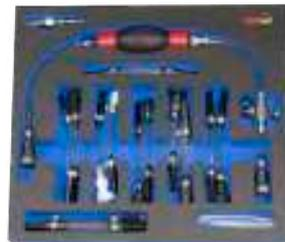

 **Composição:** (1x) Bomba de fluxo, (1x) Conector: GM, (1x) Conector pequeno: Renault, GM/Opel, Fiat, (1x) Conector grande: Renault, GM/Opel, Fiat, (1x) Conector Ford, (1x) conector 10mm: PSA, (1x) Conector 8mm: PSA, (1x) Conector Ford, (1x) Mangueira PE, (1x) Mangueira PVC, (2x) Adaptadores universais. Alta pressão: 2500Bar / 150 BAR
Baixa pressão: depende da altura do tanque

 **Composición:** (1x) Bomba de flujo, (1x) Conector: GM, (1x) Conector pequeño: Renault, GM/Opel, Fiat, (1x) Conector grande: Renault, GM/Opel, Fiat, (1x) Conector de 10 mm: PSA, (1x) Conector 8mm: PSA, (1x) Conector Ford, (1x) Manguera PE, (1x) Manguera PVC, (2x) Adaptadores universales. Alta presión: 2500Bar / 150 BAR
Baja presión: depende de la altura del tanque

REF		
6595	1,05kg	10x

 **Compressímetro para motores a gasolina**
 **Compresímetro para motores gasolina**



Borracha / Goma



REF 1408B

Manómetro



REF 1408M

Tubo



REF 1408T

 **Composição:**
(4x) Adaptadores: M10x1.0, M12x1.25, M14x1.25, M18x1.5
(2x) Tubo de ligação angular curvo e reto de borracha
(1x) Mangueira de ligação com encaixe rápido
(1x) Manómetro com encaixe rápido e válvula de alívio de pressão 0-300PSI / 0-2000kpa

 **Composición:**
(4x) Adaptadores: M10x1.0, M12x1.25, M14x1.25, M18x1.5
(2x) Tubo de unión encaje curvo y recto
(1x) Manguera de conexión con encaje rápido
(1x) Manómetro con encaje rápido y válvula de alivio de presión 0-300PSI / 0-2000kpa

REF			
1408	0-300psi	1,3kg	5x

 **Kit comparador interiores 50-160mm**
 **Kit micrometro dial 50-160mm**



1x		
1x		
12x		55-105 mm
4x		0.5, 1.0, 2.0, 3.0mm
1x		60mm
3x	Acessórios/Accessorios	

REF		
4486	1,1kg	20x

-  Comparador para regulação da bomba
 Reloj comparador para regulación bomba

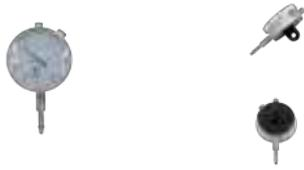

 **Descrição:** Comparador com marcação 0-10mm em intervalos 0.01mm

 **Descripción:** Reloj comparador con marcación 0-10mm en rangos 0.01mm

REF



1685

130gr

50x

-  Kit adaptadores jogo manómetro bomba de injeção diesel
 Juego adaptadores reloj comparador bomba inyección diesel



 **Medidas:** M8, M10, M12

 **Medidas:** M8, M10, M12

REF



1682

111gr

50x

-  Jogo regulação bomba diesel
 Juego regulación bomba diesel



Alfa Romeo, Audi, BMW, Saihatsu, Fiat, Ford, Isuzu, Iveco, Lancia, Land Rover, Mazda, Mitsubishi, Nissan, Renault, Rover, Volkswagen

REF



1506

1,3kg

5x

-  Jogo manómetro bomba injeção diesel
 Reloj comparador para regulación bomba inyección diesel



 **Características:**

Marcação: 1-100mm em intervalos 0.01mm
 Medidas: M10, M14

 **Características:**

Marcación 1-100mm en rangos 0.01mm
 Medidas: M10, M14

REF



1680

610gr

25x

-  Base magnética flexível para comparador
 Base magnética flexible para reloj comparador



 **Descrição:** Com interruptor ON/OFF

 **Descripción:** Con interruptor ON/OFF

REF



1686

60kg

1,4kg

10x

 Bomba teste pressão dos injetores diesel
 Bomba manual de control tarado de inyectoros



 **Características:**
O manómetro pode ser desligado com a válvula de corte girando o botão completamente no sentido horário
O manómetro de pressão (estrutura com dia. 100mm) corresponde a classe de qualidade 1.0
Adaptadores: M12, M14

 **Características:**
El indicador se puede cortar con la válvula completamente girando el mando en sentido horario
El indicador de presión (día estructura. 100mm) corresponde a la clase de calidad 1.0
Adaptadores: M12, M14

REF			
8104	0-600BAR	4,5kg	4x

 Kit ver pressão de óleo 10BAR
 Comprobador presión de aceite 10BAR



	Alfa Romeo, Fiat, Jaguar, Mitsubishi, Rover, Toyota, Audi, BMW, Citroën, Ford, Honda, Hyundai, Isuzu, Renault, SAAB, Škoda, Subaru, Lada, Lancia, Mazda, Mercedes, Nissan, Opel, Peugeot, Suzuki, VW, Volvo
--	---

REF			
5018	0-10BAR	3kg	2x

 Manómetro para verificar pressão turbos
 Manómetro para verificar presión turbos



 **Características:**
Com tubo poluretano de 2M
Escala pressão manómetro: -1 a 3 BAR
Aplicação:
Universal

 **Características:**
Con tubo de 2M de poliuretano
Escala presión manómetro: -1 a 3 BAR
Aplicación:
Universal

REF			
4482	-1 a 3 BAR	630gr	10x

 Teste fugas do turbo
 Comprobador de fugas sistema turbo



2x		70x80/85/90mm
2x		70x65/70/75mm
2x		70x50/55/60mm
2x		35/40/45mm

REF		
4484	1,9kg	5x

 **Teste fugas do turbo com manómetro**
 **Comprobador de fugas sistema turbo con manometro**



1x		80/85/90mm - entrada de ar	
1x		80/85/90mm - stop	
1x		65/70/75mm - entrada de ar	
1x		65/70/75mm - stop	
1x		50/55/60mm - entrada de ar	
1x		50/55/60mm - stop	
1x		35/40/55mm - entrada de ar	
1x		35/40/45mm - stop	
1x			

 **Composição:**

Projetado para carregar o sistema turbo com uma baixa pressão de ar regulado, para mostrar a presença de fugas dentro do sistema. Jogo fornecido com quatro pares de adaptadores escalonados para caber na maioria dos tamanhos de mangueira. Também pode ser usado em mangueiras de sistema de refrigeração.

 **Composición:**

Diseñado para cargar el sistema turbo con una baja presión de aire regulada para mostrar la presencia de fugas dentro del sistema. El kit se suministra con cuatro pares de adaptadores escalonados para adaptarse a la mayoría de los tamaños de manguera. También se puede utilizar en mangueras de sistemas de refrigeración.

REF		
4490	2,5kg	1x

 **Teste bomba de água**
 **Comprobador de bomba de agua**



1x		0-15psi
2x		
2x		
1x		
1x		2M
1x		

 **Descrição:**

Teste bomba de água foi desenvolvido para testar o sistema de refrigeração da bomba de água com o motor em funcionamento. Ajuda na deteção de problemas na bomba, os quais causados por rotores da bomba danificados, veios dos rotores da bomba presos ou correias de transmissão soltas.

 **Descripción:**

Comprobador bomba de agua está diseñado para probar el sistema de refrigeración de la bomba de agua con el motor en marcha. Ayuda a detectar los problemas de la bomba, causados por rotores dañados, ejes del rotor de la bomba atascados o correas de transmisión sueltas.

REF		
8116	1,3kg	10x

 **Teste fugas colaça com fluído CO2**
 **Comprobador de fugas para juntas de culata**



LÍQUIDO CO2 PARA
TESTE FUGAS COLAÇA
250ML

LÍQUIDO PARA
COMPROBADOR DE
FUGAS PARA JUNTAS
DE CULATA 250ML



REF 4496

 **Descrição:**

Esta ferramenta foi projetada para verificar vazamentos entre a combustão e o sistema de resfriamento de motores refrigerados a água.

 **Descripción:**

Esta herramienta ha sido diseñada para verificar fugas entre la combustión y el sistema de enfriamiento en motores refrigerados por agua.

REF		
4495	1,2kg	5x

 **Comprobador de estancamento de cilindros**
 **Comprobador de estanqueidad de cilindros**



 **Aplicação:** Para verificar a estanqueidade do cilindro.
Adaptadores: M12x1.25, M14x1.25

 **Aplicación:** Para comprobar la estanqueidad del cilindro.
Adaptadores: M12x1.25, M14x1.25

REF				
8110	0-100psi	0-7BAR	1,6kg	5x

 Kit manómetros sincronizar carburador
 Juego manómetros sincronizar carburador



 **Aplicação:** Sincroniza os valores de até 4 carburadores
Composição: (1x) placa de 4 manómetros (90mm diâmetro) (4x) tubos de extensão: 3.9x52mm, (4x) tubos de extensão: 3.9x122mm, (8x) tubos tipo cónico: 8x40m, (4x) tubos 10x53mm (M6x0.75), (4x) tubos 10x60mm (M6x1.0), (4x) tubos de borracha: 8x5x750mm

 **Aplicación:** Sincronizas los valores de hasta 4 carburadores
Composición: (1x) placa de 4 manómetros (90mm diámetro) (4x) tubos de extensión: 3.9x52mm, (4x) tubos de extensión: 3.9x122mm, (8x) tubos tipo cónico: 8x40m, (4x) tubos 10x53mm (M6x0.75), (4x) tubos 10x60mm (M6x1.0), (4x) tubos de goma: 8x5x750mm

REF			
4485	0-76cm/h	4,2kg	2x

 Kit comprovador de travões com e sem ABS
 Juego comprobador de frenos con y sin ABS



 **Adaptadores:** 7/16-24, 1/4-28, 3/8-24, 5/16-24, M10-1.5, M8-1.25, M10-1.0, 7/16-20, M7-1.0
Manómetro: 0-25Mpa 0-250Kg/cm²

 **Adaptadores:** 7/16-24, 1/4-28, 3/8-24, 5/16-24, M10-1.5, M8-1.25, M10-1.0, 7/16-20, M7-1.0
Manómetro: 0-25Mpa 0-250Kg/cm²

REF			
3237	0-25mpa	4,25kg	2x

 Bomba manual de vácuo e pressão
 Comprobador de vacío y presión



Manómetro



REF 3049M

 **Características:**
Indicador de pressão / vácuo de 63,5mm
Indicador de pressão: +0 a +3 BAR
Indicador de vácuo: -0 a -1 BAR
Pressão máx. Pressão: 3,0 BAR
Máx. Vácuo: -0,7 BAR

 **Características:**
Manómetro de presión / vacío 63,5mm
Indicador de presión: +0 a +3 BAR
Indicador de vacío: -0 a -1 BAR
Máx. Presión: 3,0 BAR
Máx. Vacío: -0,7 BAR

REF			
3049	-1 a 3BAR	3,1kg	2x

 Purgador e reposicionador de líquido de refrigeração
 Cargador y purgador neumático líquido refrigerante



 **Adaptadores:**
35mm, 39mm, 44mm (diâmetro) extensíveis até 4mm

 **Adaptadores:**
35mm, 39mm, 44mm (diámetro) extensibles hasta 4mm

REF			
2515	1,5kg	5x	

 **Kit chaves para desapertar porca ventoinha radiador**
 **Set llaves para aflojar tuerca ventilador radiador**



 **Medidas:** 2-1/4", 2-3/8", 1-3/8", 3-1/4", 3", 2-13/16",
 (2x) 1-7/16", 1-9/16", 1-7/8" (rosca esquerda), 1-7/8" (rosca direita)

 **Medidas:** 2-1/4", 2-3/8", 1-3/8", 3-1/4", 3", 2-13/16",
 (2x) 1-7/16", 1-9/16", 1-7/8" (rosca izquierda), 1-7/8" (rosca derecha)

REF		
6117	996gr	2x

 **Teste de sistemas de refrigeração 28 peças**
 **Comprobador de sistemas de refrigeración 28 piezas**



Mercedes Benz, GM, Jeep, Peugeot, Subaru, Chrysler, Acura, Mitsubishi, Nissan, Mazda, Toyota, Infiniti, Geo, Suzuki, Isuzu, Honda, Lexus, Volvo, Saab, Citroën, Renault, Fiat, Alfa Mini Cooper, VW, BMW, Ford, Opel, Porsche, Audi, etc

 **Extractor vedante radiador AC M5**
 **Extractor sello radiador AC M5**

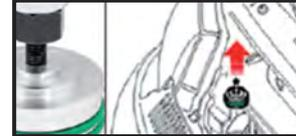

 **Características:**
 Para fácil remoção de vedantes do encaixe radiador AC
 Necessário para os radiadores AC com novo design, onde o vedante está localizado no interior da unidade em VW, Audi, Škoda, Seat, Opel e Ford, etc
 Ferramenta universal para encaixes com rosca interna de 5mm
 Aperte o parafuso (M5) do extrator na rosca da tampa do vedante

 **Características:**
 Para quitar fácilmente los sellos de la conexión del radiador de AC
 Necesario para radiadores AC con nuevo diseño, donde el sello se encuentra dentro de la unidad en VW, Audi, Škoda, Seat, Opel y Ford etc. Herramienta universal para enchufes con rosca interior de 5mm
 Apriete el tornillo extractor (M5) en la rosca de la tapa del sello

REF		
6410	800gr	10x

 **Teste sistema de refrigeração 33 peças**
 **Comprobador de sistemas de refrigeración 33 piezas**



Mercedes Benz, Audi A4, A5, A6, Opel, Ford, BMW, Volvo, Citroën, Fiat, Renault, Peugeot, VW, Universal, Mitsubishi, Nissan, Mazda, Honda, Toyota, etc

REF				
2514	0-35psi	0-2.5BAR	5kg	1x

REF		
2516	6kg	1x

-  Kit teste sistema refrigeração universal
-  Kit comprobador refrigeración universal



MB, GM, Jeep, Peugeot, Subaru, Chrysler, Acura, Mitsubishi, Nissan, Mazda, Toyota Infiniti, Geo, Suzuki, Isuzu, Honda, Acura, Lexus, Volvo, Saab, Citroën, Renault, Fiat, Alfa, Mini Cooper, VW, BMW, Ford, Opel, Porsche, Audi, etc

Descrição:
Kit de teste de sistema refrigeração universal, ajusta-se à maioria das tampas de pressão do radiador
A tampa de teste do radiador com código de cores facilita a identificação da tampa para testar fugas no sistema de radiadores. como para mudar rapidamente o líquido refrigerante em situação de vácuo
Desenho especial de ligação das ferramentas de purga e recarga a vácuo encaixa em quase todos os tipos de abertura do radiador
Abertura ajustável do adaptador de teste radiador: 40-75mm

Descripción:
El tapón de prueba del radiador con código de colores facilita la identificación del tapón para comprobar las fugas en el sistema del radiador como para cambiar rápidamente el refrigerante en una situación de vacío
El diseño especial de conexión de las herramientas de purga y carga de vacío se adapta a casi todo tipo de apertura de radiadores
Apertura ajustable del adaptador de prueba del radiador: 40-75mm

REF

2517



2,8kg



5x

-  Kit teste sistema refrigeração 5 peças
-  Comprobador refrigeración 5 piezas



Descrição:
Este kit sem tampas utiliza o sistema adaptador universal de cone para vedar e pressurizar o sistema de refrigeração
Os adaptadores são utilizados para substituir as tampas de encaixe
Quatro adaptadores universais de cone adaptam-se numa vasta gama de veículos
A bomba manual com manómetro permite testes simples e fáceis de controlar
O pino de libertação permite a despressurização

Conteúdo:
(1x) Bomba pressão
(4x) Adaptadores de cone: 17-24mm, 28-31.5mm, 37-39.5mm e 47-48.5mm

Descripción:
Este comprobador sin tapa utiliza el sistema de adaptador cónico universal para sellar y presurizar el sistema de refrigeración
Los adaptadores pueden utilizarse para reemplazar los conectores de tornillo y de bayoneta
Cuatro adaptadores cónicos universales se adaptan a una amplia gama de vehículos
La bomba manual con manómetro permite realizar pruebas controladas de forma sencilla y fácil
El pasador de liberación permite la despresurización antes del desmontaje

Contenido:
(1x) Bomba de presión
(4x) Adaptadores de cono: 17-24mm, 28-31.5mm, 37-39.5mm y 47-48.5mm

REF

2518



3,1kg



5x

-  Manómetro para ar condicionado
 Manometro para aire acondicionado



-  **Características:** Adequado para gases R12 e R134A
 Mangueiras 1500mm
 Valor de escala manómetro de pressão baixa: 0-350PSI
 (vácuo: 10 a 30 polegadas de Hg) (-40°C a + 37°C)
 Valor escala manómetro de pressão alta: 0-500PSI (-10°C a + 88°C)
-  **Características:** Adequado para gases R12 y R134A
 Mangueras 1500mm
 Valor de escala manómetro de baja presión: 0-350PSI
 (vacío: 10 a 30 pulgadas de Hg) (-40°C a +37°C)
 Valor escala manómetro de alta presión: 0-500PSI (-10°C a + 88°C)

REF				
8109	0-500psi	0-350psi	4,2kg	2x

-  Teste ar condicionado R1234YF
 Teste aire acondicionado R1234YF



-  **Características:**
 Conjunto de manómetros R1234YF com mangueiras 60"
 Alta pressão do manómetro: 0-500psi / 0~35 BAR
 Baixa pressão do manómetro: -30-120psi / -1-8 BAR
 Visor para verificação do fluxo do gás de refrigeração
 Pressão suportada pela mangueira: 800~4000 PSI R1234YF
-  **Características:**
 Conjunto Manómetro R1234YF con mangueras de 60"
 Alta presión de manómetro: 0-500psi / 0 ~ 35 BAR
 Baja presión de manómetro: -30-120psi / -1-8 BAR
 Visor para la verificación del flujo de gas refrigeración
 Presión soportada por la manguera: 800~4000 PSI R1234YF

REF				
8108	0-500psi	0-35BAR	3,1kg	5x

-  Adaptador carregamento gás 1234YF (baixa pressão)
 Adaptador carga de gas 1234YF (baja presión)



REF		
8108-03	195gr	60x

-  Adaptador carregamento gás 1234YF (alta pressão)
 Adaptador carga de gas 1234YF (alta presión)



REF		
8108-04	216gr	60x

-  Jogo 12 peças para ar condicionado
 Juego 12 piezas para aire acondicionado



2x		SW12mm, SW15mm
2x		2.2mm, 3.2mm
7x	 	TS10H, TS15H, TS20H, TS25H, TS27H, TS30H, TS40H
1x		1/4"

REF		
8105	2kg	1x

 Jogo 3 desparafusadores para abraçadeiras articuladas
 Juego 3 destornilladores para abrazaderas articulados



REF			
7012	6,7,8mm	300gr	1x

 Teste luz UV para detetar fugas ar condicionado
 Prueba luz UV para detectar fugas de aire acondicionado

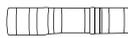
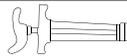

1x		3 UV - 120 lumens
1x		1500mAh
1x		
1x		
1x		
1x		

 **Descrição:** Permite a deteção de fugas nos sistemas de ar condicionado, motores, caixas de velocidades, etc. (Em conjunto com aditivos fluorescentes)

 **Descripción:** Permite la detección de fugas en los sistemas de aire acondicionado, de los motores, de las cajas de cambios, etc. (Junto con los aditivos fluorescentes)

REF		
8725	1,3kg	5x

 Detetor de fugas por fumo
 Detector de fugas por humo



 **Descrição:** Esta ferramenta foi projetada para detetar as fugas nos sistemas de tubos em carros e motos, tais como tubos de combustível, sistemas de entrada de ar e reservatório de refrigeração, e restantes sistemas de tubos e EVAP

Características:

Fonte de energia: AC220V 50Hz 1PH / DC12V
Pressão máx. saída: 18psi
Fluxo de fumo 1~6 L/min
Dimensões máquina: 176×100×258mm
Fornecimento de ar incorporado

 **Descripción:** Esta herramienta está diseñada para detectar fugas en los sistemas de tubos de automóviles y motocicletas, como las líneas de combustible, sistema de admisión de aire, y tanque de enfriamiento, así como para todo el sistema de tuberías y EVAP

Características:

Fuente de energía: AC220V 50Hz 1PH / DC12V
Presión máx. salida: 18psi
Flujo de humo 1~6 L/min
Dimensiones de la máquina: 176×100×258mm
Suministro de aire incorporado

REF		
8726	3,6kg	4x

 Termómetro infravermelhos pilhas 50°~550°C
 Termometro infrarrojos batería 50°~550°C



 **Características:**

Dimensões: 163mmx97mmx33mm (comprimento x largura x altura)
Resolução da tela LCD (precisão): 0,1°C/°F
Faixa de medição: -50°C ~ 380°C (-58°F~ 716°F)
Precisão de medição: ± 0,5°C, ± 3,0°C, ± 5,0°C
Tempo de medição: ≤ 0,5 segundos
Distância de medição: D: S = 12: 1 (relação distância-objeto, condições de medição: meio de vácuo)
Faixa de medição (medição de temperatura sem contato): - 50°C -550°C
Nota: Pilhas AAA não incluídas

 **Características:**

Tamaño: 163mmx97mmx33mm (largo x ancho x alto)
Resolución de pantalla LCD (precisión): 0,1°C /°F
Rango de medición: -50°C ~ 380°C (-58°F~ 716°F)
Precisión de medición: ± 0,5°C, ± 3,0°C, ± 5,0°C
Tiempo de medición: ≤ 0,5 segundos
Distancia de medición: D: S = 12: 1 (relación distancia-objeto, condiciones de medición: medio de vacío)
Rango de medición (medición de temperatura sin contacto): -50°C -550°C
Nota: Baterías AAA no incluídas

REF			
9630	-50°C~550°C	275gr	40x

 Chaves dinamométricas
 Llaves dinamométricas



NOTA: Chaves com certificado conforme – INTERNATIONAL STANDARD ISO 6789
 AMERICAN NATIONAL STANDARD ASME B107.14

NOTA: Llaves con certificado – INTERNATIONAL STANDARD ISO 6789
 AMERICAN NATIONAL STANDARD ASME B107.14

REF	◇	Nm	↔	⚖	📄
8240	1/4"	1-5	260mm	350gr	12x
8241	3/8"	5-25	300mm	475gr	12x
8242	1/2"	10-50	300mm	497gr	12x
8243	1/2"	25-125	400mm	634gr	12x
8244	1/2"	40-200	545mm	1,37kg	6x
8245	1/2"	70-340	760mm	1,7kg	6x

 Chave dinamométrica 3/4" 0-400Nm
 Llave dinamométrica 3/4" 0-400Nm



REF	Nm	⚖	📄
8250	0-400	1,5kg	1x

 Chave dinamométrica digital
 Llave dinamométrica digital



Nota: Funciona com 3x pilhas AAA não incluídas.

Nota: Funciona con 3 pilhas AAA no incluídas.

REF	◇	Nm	↔	⚖	📄
8249	1/2"	17-340	650mm	2,7kg	10x

 Chave dinamométrica 1/4" 5-25Nm
 Llave dinamométrica 1/4" 5-25Nm



REF	◇	Nm	↔	⚖	📄
8251	1/4"	5-25	245mm	500gr	10x

 Chave dinamométrica 3/4" 200-800Nm
 Llave dinamométrica 3/4" 200-800Nm



REF	◇	Nm	↔	⚖	📄
8252	3/4"	200-800	1210mm	8,25kg	2x

Chave dinamométrica 1" 300-1500Nm
Llave dinamométrica 1" 300-1500Nm



Descrição:
Adequado para definir o torque de aperto em parafusos de rosca direita
Concebido especialmente para aplicações industriais e do ramo automóvel (veículos ligeiros)
Design robusto
Chave longa, dividida em encaixe de duas partes
Mecanismo de roquete reversível
Pega com mecanismo fácil de bloqueio e desbloqueio
Escala de linhas a laser com ajuste fino para o respetivo valor de aluste
Punho de aço serrilhado para um ajuste fácil do valor de torque desejado, bem como um aperto seguro do mesmo
Sinal de libertação claramente audível

Descripción:
Adequado para ajustar el par de apriete en tornillos de rosca derecha
Diseñado especialmente para aplicaciones industriales y de automoción (vehículos ligeros)
Diseño robusto
Llave larga, dividida en dos partes
Mecanismo de carraca reversible
Mango con mecanismo de bloqueo y desbloqueo fácil
Escala de líneas láser con ajuste fino al valor de aluste
Mango de acero moleteado para facilitar el ajuste del valor de par de apriete requerido, así como el apriete seguro del par de apriete
Señal de desbloqueo claramente audible

REF	◇	Nm	↔	⚖	📦
8253	1"	300-1500	1795mm	12,5kg	2x

Chave dinamométrica 1" 0-1400Nm
Llave dinamométrica 1" 0-1400Nm

Chave dinamométrica 1" 0-2000Nm
Llave dinamométrica 1" 0-2000Nm



REF	↔	⚖	📦	REF	↔	⚖	📦
8246	1900mm	22,3kg	1x	8247	2400mm	25,8kg	1x

 Goniómetro 1/2"

 Goniometro 1/2"

REF	🔄	📏	📦
5233	0-360°	193gr	48x

 Goniómetro 1/2" flexível com íman

 Goniometro 1/2" flexible imantado

REF	🔄	📏	📦
4483	0-360°	520gr	24x

 Goniómetro 3/4"

 Goniometro 3/4"

REF	🔄	📏	📦
5234	360°	740gr	10x

 Fonoscópio detetor de ruídos

 Sonoscopio detetor de ruídos

 **Características:**

Auriculares e sondas super sensíveis
 Sondas metálicas de 85mm e 200mm para pontos de difícil acesso
 Tubos borracha flexíveis e resistentes

 **Características:**

Auriculares y sondas súper sensibles
 Sondas metálicas de 85mm y 200mm para puntos de difícil acceso
 Tubo de vinilo flexible de alta resistencia

REF	📏	📦
7571	158gr	48x

 Chave para válvula de pneu com limite de aperto

 Llave para válvula neumático con limite de apretón

REF	📏	📦
2500	100gr	100x

 Chave para válvula de pneu

 Llave para válvula neumático

 **Características:**

Límite de torque em 0,25nm
 Para aparafusar válvulas de vedação de borracha
 Alerta acústico ao atingir o torque máximo

 **Características:**

Límite de torque a 0,25nm
 Para enroscar válvulas con junta de goma
 Alerta acústica al alcanzar el torque máximo

REF	📏	📦
2505	100gr	1x

 Kit válvula pneu com limite de aperto TPMS
 Juego válvula neumático con limite agarre TPMS



1x		1/4": 2-14Nm
1x		0.5-3.5Nm
1x		150mm
2x		1/4": 11,12mm
3x		T10, T15, T20
1x		
1x		0.25Nm
1x		0.4Nm

REF		
2550	1,3kg	1x

 Endoscópio WI-FI 5M HD
 Endoscopio WI-FI 5M HD



 **Características:**

Resolução: HD 1280x720 Ângulo de visão: 70°
Taxa de frames: 30fps; Focagem: 4-6cm (a melhor)
Formato fotos: JPEG Formato vídeos: AVI
Diâmetro da cabeça da câmara: 8mm
Nível de impermeabilidade: IP67 Frequência: 2.4 GHz
Luz LED : 8x Luz LED ajustáveis. Distância de transmissão: 5-30M
Sistema necessário: IOS / Android / Windows / Mac

 **Características:**

Resolución: HD 1280x720 Ângulo de visión: 70°
Velocidad de fotogramas: 30fps; Enfoque: 4-6cm (mejor)
Formato de foto: JPEG Formato de video: AVI
Diámetro del cabezal de la cámara: 8mm
Nivel impermeable: IP67 Frecuencia: 2,4 GHz
Luz LED: 8x Luz LED ajustable. Distancia de transmisión: 5-30M Sistema requerido: IOS / Android / Windows / Mac

REF		
6190	224gr	50x

 Verificador anticongelante
 Probador anticongelante



 Ponto de congelamento e ebulição troca no Ethylene glycol

Ponto de congelamento - Inverno	Ponto de ebulição - Verão
-40°C	108,8°C
-34,4°C	107,7°C
-28,8°C	106,6°C
-23,3°C	105,5°C
-17°C	104,4°C
-12°C	103,3°C

 El punto de congelamiento y ebulición cambia en glicol de etileno

Punto de congelamiento - Invierno	Punto de ebulición - Verano
-40°C	108,8°C
-34,4°C	107,7°C
-28,8°C	106,6°C
-23,3°C	105,5°C
-17°C	104,4°C
-12°C	103,3°C

REF			
8727	300mm	300gr	96x

 Verificador densidade bateria
 Probador densidad bateria



 A marca no flutuador que está alinhada com a superfície indica a condição

Vermelho	1100-1205	Carga bateria descarregada
Branco	1205-1260	Carga bateria necessita atenção
Verde	1260-1300	Carga bateria está OK

 La marca en el flotador que está alineada con la superficie indica la condición

Rojo	1100-1205	Carga bateria descargada
Blanco	1205-1260	Carga bateria necesita atención
Verde	1260-1300	Carga bateria está OK

REF			
8728	300mm	300gr	96x

-  Jogo de cabos 25mm
 Juego de cables 25mm



-  **Características:**
 Com terminais isolados
 Comprimento total: 3.5m
 Corrente máxima: 350 AMP

-  **Características:**
 Con terminales aislados
 Longitud total: 3.5m
 Corriente máxima: 350 AMP

REF



6170

350 AMP



1,7kg



10x

-  Teste bateria 6-12V
 Comprobador bateria 6-12V



-  **Corrente de carga fixa:**
 Teste de carga de 100 AMP - Baterias 12V até 1.000 CCA
 Teste de carga de 50 AMP - Baterias 6V até 1.000 CCA
 Precisão de voltagem: $\pm 0.2V$

- Ciclo de teste:**
 10 Segundos por teste com 1min arrefecimento
 3 Testes em 5 minutos

-  **Corriente de carga fija:**
 Prueba de carga de 100 AMP - Baterías 12V hasta 1.000 CCA
 Prueba de carga de 50 AMP - Baterías 6V hasta 1.000 CCA
 Precisión del voltaje: $\pm 0,2V$

- Ciclo de prueba:**
 10 Segundos por prueba con 1min de enfriamiento
 3 Pruebas en 5 minutos

REF



6162

6V/12V



1,1kg



10x

-  Teste bateria digital com impressora
 Comprobador baterial digital



-  **Aplicações:**
 Teste baterias 6V/12V e sistemas de arranque e carga 12V/24V

Características:

Tipo baterias: Líquido regular, AGM, AGM START/STOP, EFB START/STOP, GEL, VRLA
 Intervalo CCA: 40~2000CCA (SAE)
 Intervalo Voltagem: 1.5-30V
 Precisão: voltagem 0.1V, CCA 5%, IR 5%
 Temperatura funcionamento: 14oF-122 oF (-10°C - 50°C)
 Resistência interna, teste de temperatura ambiente
 Visor SOH (estado saúde), SOC (estado de carga)
 Teste para vários padrões de bateria: JIS, SAE
 DIN, EN, IEC, CA. Visor LCD gráfico de 3,2" com luz de fundo, brilho ajustável
 Impressora para imprimir relatórios de teste, informações personalizadas do utilizador também podem ser impressas
 Vários idiomas são exibidos
 Rolo papel térmico com medidas de 57mm x 6.5m
 Compensação da temperatura ambiente
 Função de upload de dados

-  **Aplicaciones:**
 Prueba baterías de 6V/12V y sistemas de arranque y carga de 12V/24V

Características:

Tipo de batería: Líquido normal, AGM, AGM START/STOP, EFB START/STOP, GEL, VRLA
 Rango CCA: 40~2000 CCA (SAE). Rango de voltaje: 1,5-30 V
 Precisión: voltaje 0,1 V, CCA 5%, IR 5%
 Temperatura de funcionamiento: 14°F-122°F (-10°C - 50°C)
 Resistencia interna, prueba a temperatura ambiente
 Pantalla SOH (estado de salud), SOC (estado de carga)
 Prueba para varios estándares de batería: JIS, SAE
 DIN, EN, IEC, CA. Pantalla gráfica LCD de 3,2" con retroiluminación, brillo ajustable
 Impresora para imprimir informes de prueba, también se puede imprimir información personalizada del usuario
 Se muestran varios idiomas
 Rollo de papel térmico de 57mm x 6,5m
 Compensación de temperatura ambiente
 Función de carga de datos

REF

6164

6/12/24V

1,85kg

8x

 **Teste bateria digital com impressora**
 **Comprobador de baterías digital con impresora**



2x Rolos / 2x Rollos
38x25mm

REF 6163P

Normas: SAE, DIN, ENC1, ENC2, EIC

 **Características:** Mede o estado de carga, a capacidade e vida da bateria. Comprova o sistema de arranque, de carga e o estado dos díodos do alternador. Codificação da prova efectuada. Prova as baterias de 6V e 12V e sistemas de carga de 12V e 24V Comprova baterias a baixo de 1.5V. Intervalo de operação 40-2000 CCA. Monitor LCD. Impressão dos resultados num ticket. Possibilidade de escolha dos idiomas do menu

 **Características:** Mide el estado de carga, la capacidad y la duración de la batería. Demuestra marcha en un, y el estado de carga los diodos del alternador. Codificación de prueba hecho. Baterías a prueba de 6V y 12V y sistemas de carga 12V y 24V. Demuestra baterías bajo 1.5V. Rango de operación 40-2000 CCA. Monitor LCD. Imprimir los resultados en un ticket. Posibilidad de elegir los idiomas del menú

REF			
6163	6/12/24V	1,5kg	1x

 **Teste bateria digital c/ impressora**
 **Comprobador batería digital**



2x Rolos papel térmico /
2x Rollos de papel



REF 6165P

Normas: CCA (100-2000A), EN (100-2000A), SAE (100-2000A), CA (100-2000A), BCI (100-2000A), GB (30-220Ah), MCA (100-2000A), JIS (26A17-245H52), DIN (100-1400A), IEC (100-1400A)

 **Características:**
Testar a bateria e os sistemas de carregamento/arranque
Os últimos resultados dos testes são guardados automaticamente e revistos
Modo de impressão de data/hora ajustável
Teste rápido e com um só clique
Imprimir através da impressora incorporada. Proteção contra curto-circuito e ligação inversa
Disponível: Bateria de 12V e sistemas de carregamento/arranque
Dimensão: 210x90x40mm Voltagem de entrada: 8-30V
Ecrã: 128x64 LCD, ecrã retroiluminado

 **Características:**
Probar la batería y los sistemas de carga/arranque
Los últimos resultados de las pruebas se guardan automáticamente y pueden revisarse
Modo de impresión de fecha/hora ajustable
Prueba rápida con un solo clic
Impresión mediante impresora incorporada. Protección contra cortocircuito e inversión de polaridad
Disponible para: Bateria de 12V y sistemas de carga/arranque
Dimensiones: 210x90x40mm. Voltaje de entrada: 8-30V
Pantalla: LCD 128x64, pantalla retroiluminada

REF			
6165	8/30V	1kg	10x

 **Protetor de memórias ligação OBD**
 **Protector de memórias ligación OBD**



 **Características:**
Adaptador especial de prevenção para que não perca nenhuma informação enquanto substitui a bateria
Conecte o adaptador da bateria à tomada OBD-II para uma energia constante
Fornecimento de energia opcional: Bateria 12v, Pilha seca 9v.
O adaptador possui 2 LED's para lhe mostrar se a bateria possui energia suficiente, e mostra-lhe se a conexão ao carro está correcta
Comprimento do fio de 12V é de: 1600mm
Comprimento do fio de 9V é de: 450mm

 **Características:**
Adaptador especial la prevención para que no se pierda ninguna información al sustituir la batería
Conecte el adaptador de batería en el OBD-II para una energía constante
Suministro de alimentación opcional: 12v, 9V batería seca
El adaptador tiene 2 LED's para mostrar que la batería tiene energía suficiente, y le mostrará si la conexión a la unidad es correcta
La longitud del cable de 12V es: 1600mm
La longitud del cable de 9V es: 450mm

REF		
9610	60gr	1x

 **Detetor corte circuito e curto-circuito**
 **Detector corte circuito y cortocircuito**



 **Características:**
Com sonda flexível
Projetado para identificar e rastrear fios ou cabos sem danificar o isolamento
Também pode ser usado na verificação de curto-circuito, localização de circuito aberto, localização de fios, identificação de fios e assim por diante
Adequado para corrente de circuito DC 6-42 volts
Diagnóstico rápido e fácil

 **Características:**
Con sonda flexible
Diseñado para identificar y rastrear cables sin dañar el aislamiento
También se puede utilizar en la comprobación de cortocircuitos, localización de circuitos abiertos, localización de cables, identificación de cables, etc
Adequado para circuitos de corriente DC de 6-42 voltios
Diagnóstico rápido y sencillo

REF		
9615	360gr	25x

-  Auto tester 3-48V
 Comprobador de tensión 3-48V



REF	⚡	📏	📦
9606	3/48V	76gr	100x

-  Cabo diagnóstico/serviço Tesla model 3/Y
 Cable de diagnóstico y servicio para Tesla modelo 3/Y



	Tesla Model 3, Model Y
OEM	1137658-00-C

  **Características:** Comprimento: 1,5m (5 pés) / Longitud: 1,5 m (5 pies)

REF	📏	📦
9609	55gr	100x

-  Cabo diagnóstico/serviço Tesla model X/S
 Cable de diagnóstico y servicio para Tesla modelo X/S



	Tesla Modelo S/X (2016)
OEM	1013230-00-A

  **Características:** Comprimento: 1,5m (5 pés) / Longitud: 1,5 m (5 pies)

REF	📏	📦
9608	55gr	100x

-  Busca polos 6/12/24V
 Buscapolos 6/12/24V



Fusível / fusible



REF 9607FU

REF	⚡	📏	📦
9607	6/12/24V	76gr	144x

-  Manómetro encher pneus 0-170psi alta precisão
 Inflador de neumáticos 0-170psi alta precisión



Agulha / Boquilla



REF 3502-01

REF	📏	📏	📏	📦
3502	0-170psi	0-12BAR	1,2kg	20x

-  Manómetro encher pneus 0-170psi
 Inflador de neumáticos 0-170psi



Agulha / Boquilla



REF 3503-01

REF	📏	📏	📏	📦
3503	0-170psi	0-20BAR	653gr	30x

 Conectores prova de água auto 424 peças
 Conectores prueba de agua auto 424 piezas



Composição:
(4x) Conectores macho 1 pino; (4x) Conectores fêmea 1 pino
(4x) Conectores macho 2 pinos; (4x) Conectores fêmea 2 pinos
(6x) Conectores macho 3 pinos; (6x) Conectores fêmea 3 pinos
(3x) Conectores macho 4 pinos; (3x) Conectores fêmea 4 pinos
(3x) Conectores macho 5 pinos; (3x) Conectores fêmea 5 pinos
(2x) Conectores macho 6 pinos; (2x) Conectores fêmea 6 pinos
(100x) Terminais macho
(100x) Terminais fêmea
(180x) Terminais com anilhas amarelas

Composición:
(4x) Conectores macho 1 pin; (4x) Conectores hembra 1 pin
(4x) Conectores macho 2 pinos; (4x) Conectores hembra 2 pinos
(6x) Conectores macho 3 pinos; (6x) Conectores hembra 3 pinos
(3x) Conectores macho 4 pinos; (3x) Conectores hembra 4 pinos
(3x) Conectores macho 5 pinos; (3x) Conectores hembra 5 pinos
(2x) Conectores macho 6 pinos; (2x) Conectores hembra 6 pinos
(100x) Terminales macho
(100x) Terminales hembra
(180x) Terminales con arandelas amarillas

REF		
4401	640gr	20x

 Máquina focar faróis
 Regulador de faros



Características:
Adequado para verificar e ajustar qualquer tipo de farol (faróis altos, baixos e de nevoeiro), incluindo faróis com lâmpadas XENON e LED
Apropriado para uso em garagens e linhas técnicas de inspeção
Para veículos ligeiros e pesados
Tela de mira interna com escala para veículos com volante à direita e à esquerda
Viseira de alinhamento de arame de aço com sistema de calibração
Sistema de ajuste de altura com sistema de bloqueio
Luxímetro digital
Uso confortável devido ao posicionamento das rodas
Base antiderrapante robusta
Fornecido com manuais de montagem, funcionamento e calibração

Características:
Adequado para comprobar y ajustar cualquier tipo de faro (luces altas, bajas y antiniebla), incluidos los faros con XENON y lámparas LED
Apto para uso en garajes y líneas de inspección técnica
Para vehículos ligeros y pesados
Pantalla de observación interna con escala para vehículos con volante a derecha e izquierda
Visor de alineación de alambre de acero con sistema de calibración
Sistema de ajuste de altura con sistema de bloqueo
Medidor de lux digital
Uso cómodo debido al posicionamiento de las ruedas
Base robusta antideslizante
Se suministra con manuales de montaje, operación y calibración

REF		
6900	23kg	1x

Máquina focar faróis duplo laser
Regulador de faros laser doble

Características:

Adequado para verificar e ajustar qualquer tipo de farol (faróis alto, baixo e nevoeiro), incluindo faróis com lâmpadas XENON e LED
 Adequado para uso em garagens e linhas técnicas de inspeção
 Para veículos ligeiros e pesados
 Tela de medição regulável interna com escala para veículos com volante à direita e à esquerda
 Visor de alinhamento a laser + punteiro laser central para facilitar o posicionamento da unidade na frente do veículo
 Sistema de ajuste de altura com sistema de bloqueio
 Luxímetro digital
 Uso confortável devido ao posicionamento das rodas
 Base anti derrapante robusta
 Fornecido com manuais de montagem, operação e calibração

Características:

Adequado para comprobar y ajustar cualquier tipo de faro (luces altas, bajas y antiniebla), incluidos los faros con lámparas XENON y LED
 Apto para uso en garages y líneas de inspección técnica
 Para vehículos ligeros y pesados
 Pantalla de medición interna ajustable con escala para vehículos con dirección derecha e izquierda
 Pantalla de alineación láser + puntero láser central para facilitar el posicionamiento de la unidad frente al vehículo
 Sistema de ajuste de altura con sistema de bloqueo
 Medidor digital de lux
 Uso cómodo debido al posicionamiento de las ruedas
 Robusta base antideslizante
 Se suministra con manuales de montaje, operación y calibración

REF
6901
23kg
1x

FERRAMENTA MOTOR

HERRAMIENTA PARA MOTOR

07



KROFtools[®]
PROFESSIONAL TOOLS

 FAMÍLIA	PÁGINAS
01 FERRAMENTA MANUAL	11-106
02 ALICATES	109-120
03 BITS E CONJUNTOS	123-134
04 FERRAMENTA ESPECÍFICA	137-214
05 FERRAMENTA CARROÇARIA	217-222
06 REGULAÇÃO E TESTE	225-246
07 FERRAMENTA MOTOR	249-276
08 KITS SINCRONIZAÇÃO	279-350
09 FERRAMENTA ELÉTRICA	353-362
10 FERRAMENTA PNEUMÁTICA	365-378
11 FERRAMENTA HIDRÁULICA	381-404
12 FERRAMENTA LUBRIFICAÇÃO	407-414
13 EQUIPAMENTO GARAGEM	417-502
RT ROUPA DE TRABALHO	505-508
MR MERCHANDISING	511-514
EP EXPOSITORES	517-524
LR LOCALIZAÇÃO REFERÊNCIAS	527-538

 FAMILIA	PÁGINAS
01 HERRAMIENTA MANUAL	11-106
02 ALICATES	109-120
03 PUNTAS Y CONJUNTOS	123-134
04 HERRAMIENTA ESPECÍFICA	137-214
05 HERRAMIENTA DE CARROCERIA	217-222
06 REGULACIÓN Y PRUEBAS	225-246
07 HERRAMIENTA PARA MOTOR	249-276
08 KIT CALADO	279-350
09 HERRAMIENTA ELÉCTRICA	353-362
10 HERRAMIENTA NEUMÁTICA	365-378
11 HERRAMIENTA HIDRÁULICA	381-404
12 HERRAMIENTA LUBRICACIÓN	407-414
13 EQUIPAMENTO PARA TALLER	417-502
RT ROPA DE TRABAJO	505-508
MR MERCHANDISING	511-514
EP EXPOSITORES	517-524
LR LOCALIZACIÓN REFERENCIAS	527-538



 **Jogo 30 peças chave filtro óleo**
 **Juego llaves de filtro aceite 30 piezas**



 **Descrição:** (1x) Extrator filtro 3 garras Ø 65-120mm, (1x) Redução 1/2" (12.5 mm) x 3/8" (10mm), (28x) Chaves de filtro

 **Descripción:** (1x) Extractor de filtro de 3 puntas Ø 65-120mm (1x) Reducción 1/2" (12.5 mm) x 3/8" (10mm), (28x) Llaves para filtros

Medidas	Modelos
65mm/14f	Daihatsu, Toyota, Nissan, Fiat
65-67mm/14f	Daihatsu, Toyota
66mm/6f	Fiat Punto 1.2, Renault
68mm/14f	Mazda, Ford Escort, Subaru
73mm/14f	Toyota, Lexus
74mm/15f	Audi, GM, Rover, Chrysler
74-76mm/15f	Ford, Opel, VW, Audi, Mercedes
75-77mm/15f	VW, Audi, Ford, Isuzu, Mercedes, Opel
76mm/8f	Fiat Marea, Lancia Delta
76mm/12f	Fiat, Renault, Mercedes
76mm/14f	VW, Mercedes, Porsche, BMW, Audi, Opel
76mm/30f	Ford, Motorcraft FL400A
78mm/15f	Nissan, Ford, Toyota
80mm/15f	Nissan, Honda, Opel, Mazda
80-82mm/15f	Subaru, Toyota, Honda, Mazda, Nissan
86mm/16f	Volvo S40 / S60 / S70 / S80
86mm/18f	VW, Audi, Renault, Peugeot, Citroën
90mm/15f	Subaru, Toyota, Honda, Mazda, Nissan
92mm/10f	Fiat, Lancia
93mm/15f	Mazda, Volvo, Mitsubishi, Nissan, Honda
93mm/36f	Ford, Motorcraft FLINFLA 1B, FL3001, FL320
93mm/45f	VW, Audi
95mm/15f	Toyota, Alfa, GM, Ford, Chrysler
96mm/18f	VW, Renault
100mm/15f	Isuzu, Mitsubishi
106mm/15f	Fiat Ducato 2.5D
108mm/15f	Volvo Diesel C70 / S70 / N70 / 850 Tdi
108mm/18f	Renault Espace / Laguna / Master / Safrane / Traffic 2.4+2.5+2.8D+Tdi

REF	⬠	⚖️	📦
6515	3/8"	5,6kg	2x

 **Jogo chaves remoção filtro óleo 7pcs**
 **Juego llaves remocion filtro aceite 7pcs**



 **Composição:** Conjunto de chaves de pé de galo: 24mm, 27mm, 29mm, 30mm, 32mm, 36mm e 38mm com acionamento de 3/8"

 **Composición:** Juego de llaves de pata de gallo: 24mm, 27mm, 29mm, 30mm, 32mm, 36mm y 38mm con accionamiento de 3/8"

REF	⚖️	📦
4088	625gr	24x

 **Chaves de filtro 3/8"**
 **Llaves de filtro 3/8"**



REF	⬠	⚖️	📦
6606	66/06f/c	89gr	96x
6514	65/14f/c	100gr	100x
656714	65-67/14f/c	100gr	100x
6814	6814f/c	94gr	96x
7314	73/14f/c	124gr	50x
7415	74/15f/c	100gr	100x
7608	76/8f/c	100gr	1x
7612	76/12f/c	100gr	100x
7614	76/14f/c	110gr	50x
7630	76/30f/c	100gr	1x
747615	74-76/15f/c	100gr	1x
757715	75-77/15f/c	124gr	50x
7815	78/15f/c	100gr	1x
808215	80/82/15f/c	100gr	1x
8015	80/15f/c	100gr	100x
8616	86/16f/c	132gr	50x
8618	86/18f/c	100gr	1x
9015	90/15f/c	100gr	1x
9210F	92/10f/c	100gr	1x
9315	93/15f/c	100gr	1x
9336	93/36f/c	100gr	1x
9345	93/45f/c	100gr	1x
9515	95/15f/c	100gr	1x
9618	96/18f/c	100gr	100x
10015	100/15f/c	100gr	1x
10615	106/15f/c	100gr	1x
10815	108/15f/c	100gr	1x
10818	108/18f/c	100gr	1x

 **Chave filtro ajustável com gatilho 66-80mm**
 **Llave de filtro ajustable con gatillo 66-80mm**



 **Descrição:** Chave ajustável com encaixes ranhurados, pega longa, mola e gatilho, para remover filtros de óleo com um diâmetro entre 66 e 80mm

 **Descripción:** Llave ajustable con insertos ranurados, mango largo, muelle y gatillo, para desmontar filtros de aceite con un diámetro entre 66 y 80mm

REF	⬠	⚖️	📦
5440	60-80mm	690gr	50x

	<p>Audi: A6 3.2 TSi V6 (2004) BMW Mini: M52 series 3 e 5, M60 6 cilii. series 5, 7, 8, M73 12 cilii. series 7, 8. Ford: Transit 2.2, 2.4, 3.2 (2006), Fiesta 1.4, 1.6 TDCi Mercedes-Benz: Classe A, 220d, E220d, M604, C250d, E250d, M605, E300d, M606 mb. MB Transporter M616, 116MB, 100 Renault: 1.5, 1.9, 2.2, 2.5 dci Seat: Ibiza (1993-) Škoda: Fabia (1999-) gasolina 1.4 16v Opel: Vectra B di 16v (1998-), Astra/Zafira, Astra-G /Corsa-B. Volkswagen: Lupo 1.2 TDi, Touareg TDi, 2.0, 2.2 TDi, Polo 1.2, Polo (1995-), Golf (1992-), Transporter T5 1.9 (2004)</p>
---	---

 Jogo 19 peças chaves de filtro - 2.ª geração
 Juego 19 piezas llaves de filtro - 2.ª generación



Chave filtro óleo
 Extractor 92mm x
 15pt Nissan / Subaru



REF 65169215

Chave filtro óleo
 Extractor 94.5mm x
 15pt Nissan / Toyota



REF 651694515

Chave filtro óleo
 Extractor filtro 100.5mm
 x 15pt - Mazda /
 Mitsubishi



REF 651610015

Chave filtro óleo
 Extractor filtro 24mm x
 6pt BMW / Opel / Jeep



REF 6516246

Chave filtro óleo
 Extractor filtro 27mm x
 6pt Mercedes



REF 6516276

Chave filtro óleo
 Extractor filtro 30mm x
 6pt VW



REF 6516306

Chave filtro óleo
 Extractor filtro 32.5mm
 x 6pt VW



REF 65163256

Chave filtro óleo
 Extractor filtro 36mm
 x 6pt Opel / BMW /
 Mercedes / VW



REF 6516366

Chave filtro óleo
 Extractor filtro 38mm x
 6pt Opel



REF 6516386

Chave filtro óleo
 Extractor filtro 63-64mm
 x 14pt Toyota



REF 65166314

Chave filtro óleo
 Extractor filtro 66.5mm x
 14pt Ford / Mazda



REF 651666514

Chave filtro óleo
 Extractor filtro 70mm x
 14pt Lexus



REF 65167014

Chave filtro óleo
 Extractor filtro 74mm x
 14pt Mercedes



REF 65167414

Chave filtro óleo
 Extractor filtro 79mm x
 15pt Toyota / Honda /
 Mitsubishi / Mazda



REF 65167915

Chave filtro óleo
 Extractor 79.5mm x
 14pt Lexus



REF 651679514

Chave filtro óleo
 Extractor 84mm x
 14pt Dodge / Mercedes
 / Jeep



REF 65168414

Chave filtro óleo
 Extractor 87mm x
 16pt Volvo



REF 65168716

 **Composição:**

- (1x) Chave filtro óleo 100.5mm x 15pt Mazda/Mitsubishi
- (1x) Chave filtro óleo 24mm x 6pt BMW/Opel/Jeep
- (1x) Chave filtro óleo 27mm x 6pt Mercedes
- (1x) Chave filtro óleo 30mm x 6pt VW
- (1x) Chave filtro óleo 32.5mm x 6pt Opel/BMW
- (1x) Chave filtro óleo 36mm x 6pt Opel/BMW/Mercedes/VW
- (1x) Chave filtro óleo 38mm x 6pt Opel
- (1x) Chave filtro óleo 63-64mm x 14pt Toyota
- (1x) Chave filtro óleo 66.5mm x 14pt Ford/Mazda
- (1x) Chave filtro 70mm x 14pt Lexus
- (1x) Chave filtro óleo 74mm x 14pt Mercedes
- (1x) Chave filtro óleo 79mm x 15pt Toyota/Honda/Mitsubishi/Mazda
- (1x) Chave filtro óleo 79.5mm x 14pt Lexus
- (1x) Chave filtro óleo 84mm x 14pt Dodge/Mercedes/Jeep
- (1x) Chave filtro óleo 87mm x 16pt Volvo
- (1x) Chave filtro óleo 92mm x 15pt Nissan/Subaru
- (1x) Chave filtro óleo 94.5mm x 15pt Nissan/Toyota
- (1x) Adaptador 12.5 (1/2") x 10 (3/8")
- (1x) Chave de garra para filtro de óleo

 **Composición:**

- (1x) Llave filtro de aceite 100.5mm x 15pt Mazda/Mitsubishi
- Llave filtro de aceite 24mm x 6pt BMW/Opel/Jeep
- (1x) Llave filtro de aceite 27mm x 6pt Mercedes
- (1x) Llave filtro de aceite 30mm x 6pt VW
- (1x) Llave filtro de aceite 32.5mm x 6pt Opel/BMW
- (1x) Llave filtro de aceite 36mm x 6pt Opel/BMW/Mercedes/VW
- (1x) Llave filtro de aceite 38mm x 6pt Opel
- (1x) Llave filtro de aceite 63-64mm x 14pt Toyota
- (1x) Llave filtro de aceite 66.5mm x 14pt Ford/Mazda
- (1x) Llave filtro 70mm x 14pt Lexus
- (1x) Llave filtro de aceite 74mm x 14pt Mercedes
- (1x) Llave filtro de aceite 79mm x 15pt Toyota/Honda/Mitsubishi/Mazda
- (1x) Llave filtro de aceite 79.5mm x 14pt Lexus
- (1x) Llave filtro de aceite 84mm x 14pt Dodge/Mercedes/Jeep
- (1x) Llave filtro de aceite 87mm x 16pt Volvo
- (1x) Llave filtro de aceite 92mm x 15pt Nissan/Subaru
- (1x) Llave filtro de aceite 94.5mm x 15pt Nissan/Toyota
- (1x) Adaptador 12.5 (1/2") x 10 (3/8")
- (1x) Llave de garra para filtro de aceite

REF

6516



4,1kg



1x

 Chave filtro 76-12 alumínio
 Llave filtro 76-12 aluminio



Mazda, Mitsubishi, Ford, Citroën

REF
7612AREF
100grREF
96x

 Chave filtro 74-14 alumínio
 Llave de filtro 74-14 aluminio



VW, Mercedes, BMW, Audi, Opel

REF
7414REF
100grREF
100x

 Jogo chaves filtro de óleo
 Juego llaves filtro aceite



 **Composição:** (7x) chaves filtro: 24, 27, 29, 30, 32, 36, 38mm (6 faces)
Quadra: 3/8"
Nota: Projetado para uso profissional e aplicações pesadas
 **Composición:** (7x) llaves filtro: 24, 27, 29, 30, 32, 36, 38mm (6 caras)
Cuadrado: 3/8"
Nota: Diseñado para uso profesional y aplicaciones de servicio pesado

REF			
4087	3/8"	1,4kg	10x

 Chave filtro Opel 74.7mm
 Llave filtro Opel 74.7mm



 **Descrição:**
Concebido para remover e encaixar com segurança a carcaça do filtro de óleo plástico sem danificar
Aplicação:
Motores diesel de três cilindros 1,5 da gama Opel (posterior 2019)
Características:
Quadra de 1/2"
15 ranhuras / 74,7mm

 **Descripción:**
Diseñado para extraer e instalar con seguridad la carcasa de plástico del filtro de aceite sin dañarla
Aplicación:
Motores diésel 1.5 de tres cilindros de la gama Opel (posterior 2019)
Características:
Cuadrado 1/2"
15 ranuras / 74,7 mm

REF			
74715	1/2"	290gr	32x

 Chave de filtro diesel Ford transit 2.2 TDCI
 Llave de filtro diesel Ford transit 2.2 TDCI



 **Aplicação:** Especialmente desenhada para remover o filtro de combustível nos motores Ford transit 2.2L TDCI
Devido ao seu desenho evita que o filtro escorregue
Usar com uma quadra 1/2"

 **Aplicación:** Especialmente diseñado para extraer el filtro de combustible en los motores Ford transit 2.2L TDCI
Gracias a su diseño, evita que el filtro se deslice
Utilizar con un cuadrado 1/2"

REF			
5340		298gr	40x

 Chave filtro 74.5mm 15pt ford 1.5/1.6 Ecoboost
 Llave filtro 74.5mm 15pt ford 1.5/1.6 Ecoboost



 **Descrição:**
Design offset, ideal para utilização em áreas confinadas
Para utilização nos motores Ford 1.5 e 1.6L EcoBoost equipados com um filtro Motorcraft
Especificações:
Tamanho: 74,5mm x 15 caneluras x 3/8" Dr

 **Descripción:**
Diseño offset, ideal para su uso en espacios reducidos
Para uso en motores Ford 1.5 y 1.6L EcoBoost equipados con un filtro Motorcraft
Especificaciones:
Tamaño: 74.5mm x 15 flautas x 3/8" Dr

REF			
5341		250gr	40x

 Ferramenta remoção tampa proteção bomba combustível Ford 2.0 diesel
 Herramienta de cobertura de bomba de combustible para Ford 2.0 diesel ecoblue



	Ford 2.0lt EcoBlue
	JB3Q-6095-AA

REF			
5319		53g	48

 Alicates ajustável filtro
 Alicates ajustable filtro



REF	⊖	↔	⚖	📦
6260	50-88mm	250mm	437gr	48x
6265	60-102mm	300mm	513gr	36x
6275	60-102mm	300mm	513gr	36x

 Alicates ajustável filtro 3 posições
 Aliate ajustable filtro 3 posiciones



REF	⊖	↔	⚖	📦
6270	65-120mm	330mm	733gr	30x

 Chave de filtro cinta óleo
 Llave filtro de fleje

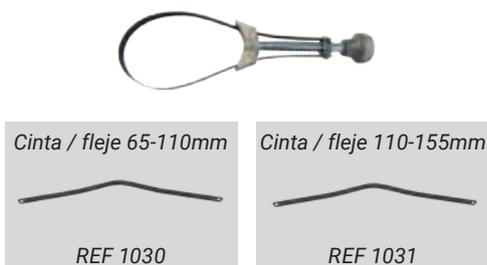

REF	⊖	⚖	📦
1028	65-110mm	200gr	50x
1029	110-155mm	200gr	50x

 Chave filtro de óleo cinta com punho ergonómico
 Llave filtro de fleje con mango ergonómico



REF	⊖	⚖	📦
1026	65-110mm	291gr	50x
1027	110-155mm	354gr	1x

 Chave de filtro com corrente dupla
 Llave de filtro con cadena doble



Características:

Fléxivel para espaços reduzidos
 Apropriado para chaves de filtro entre 60-160mm
 Comprimento corrente: 520mm

Características:

Flexible para espacios reducidos
 Adecuado para llaves de filtro entre 60-160mm
 Longitud de la cadena: 520mm

REF	⊖	↔	⚖	📦
6281	60-160mm	520mm	958gr	24x

 Chave de filtro óleo 27mm
 Llave de filtro aceite 27mm



	2.0, 2.2
	DW10C, DW12C, TXBA (DW10C), TXDA (DW10C), TXWA (DW10C), KNBA, (DW12C), KNBB (DW12C), KNWA (DW12C), AJi4D/224DT
	Citroën, Peugeot, Ford, Jaguar (09-12)

REF	◇	⚖	📦
6650	1/2"	575gr	20x

 Chave de filtro óleo para camião
 Llave de filtro para camión



REF	⊖	⚖	📦
6280	271mm	400gr	48x

 Extrator filtros 3 garras
 Extractor filtros 3 garras



REF	⊖	⚖	📦
5410	63-105mm	375gr	40x

 Chave filtro magnética 3 garras 3/8" 58-98mm
 Extractor filtro imantada aceite 3 garras 3/8" 58-98mm



 **Descrição:**
Chave de filtro de três garras com adaptador para quadra 3/8" ou 1/2"
Funciona com filtros de óleo com diâmetro que varia de 58-98mm
Ímã forte para segurar a chave no lugar

 **Descripción:**
Llave de filtro de tres brazos con adaptador para accionamiento de 3/8" o 1/2"
Funciona con filtros de aceite de diámetro de 58-98mm
Lo fuerte Imán puede mantener la llave en su sitio

REF			
5430	65-110mm	590gr	40x

 Chave filtro 3 garras
 Extractor filtros 3 garras



 **Características:**
Chave filtro de três garras com adaptador quadra 3/8" ou 1/2"

 **Características:**
Llave para filtros de tres garras con adaptador cuadrado de 3/8" o 1/2"

REF			
5415	65-120mm	605gr	40x

 Chave filtro 3 garras
 Extractor filtro 3 garras



 **Características:**
Chave filtro de três garras com adaptador quadra 1/2"

 **Características:**
Llave para filtros de tres garras con adaptador cuadrado 1/2"

REF			
5420	90-157mm	1kg	24x

 Chave de filtro 3 garras 3/8"
 Extractor filtro 3 garras 3/8"



REF			
5310	65-110mm	590gr	40x

 Chave de filtro reversível
 Llave de filtro reversible



 **Características:**
Trabalha com roquete de 3/8"

 **Características:**
Funciona con una carraca de 3/8"

REF			
6246	70-110mm	300gr	30x

 Chave de filtro para motas
 Llave de filtro para motos



REF			
6642	54-110mm	605gr	40x

 Chave filtro óleo 74.5mm Fiat/Lancia
 Extractor filtro 74.5mm Fiat/Lancia



	Fiat: 500, Panda Lancia: Ypsilon
	46796687

REF		
7450	225g	40

-  Tubo drenar filtro óleo motor VAG
 Tubo drenaje filtro aceite motor VAG



	2.55 cil. VWTransporter (AXD,AXE,BNZ,BPC). 2.0 turbo gasolina (BPY) VW Jetta, Golf, Passat, EOS. Audi A3, A4 (BPG,BWT)
	VAG, TSI, GTI

REF		
5320	200gr	1x

-  Jarro medidor
 Jarra medidora

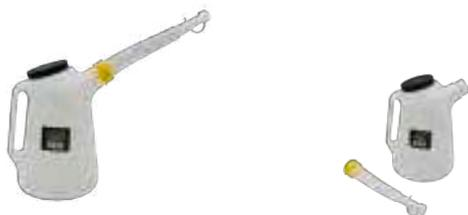

REF			
3253	3L	207gr	40x
3255	5L	343gr	16x

-  Jerricã
 Bidón



REF 3301J5

REF 3301J10

REF 3301J20

REF			
3301J5	5L	390gr	16x
3301J10	10L	625gr	8x
3301J20	20L	2,625kg	4x

-  Bomba trasfega manual
 Bomba manual extracción



-  **Medidas:**
 Tubo curto de 380mm + tubo longo de 1100mm
Aplicações:
 Óleo, gasolina, fluido, água, diesel e anticongelante
-  **Medidas:**
 Tubo corto de 380mm + tubo largo de 1100mm
Aplicaciones:
 Aceite, gasolina, fluido, agua, diesel y anticongelante

REF		
3279	128gr	50x

-  Jarro para enchimento de baterias
 Jarra para llenar baterias



-  **Características:**
 Ponta do jarro com sistema de bloqueio
 Diâmetro interno ponta: 6mm
 Diâmetro externo ponta: 11mm

-  **Características:**
 Punta de jarra con sistema de bloqueo
 Diámetro interno punta: 6mm
 Diámetro externo punta: 11mm

REF			
3250	2L	2,4kg	1x

-  Bomba trasfega a pilhas c/ 3 adaptadores
 Bomba aspiracion fluido baterias con 3 adaptadores



-  **Características:**
 Potência: 4 pilhas "AA" (NÃO incluídas)
 Tubo de Sucção: 457mm; Mangueira de Descarga: 990mm
 Volume de Entrega: 9,1 litros por minuto
 Auto-Stop: Sistema de auto-paragem incorporado
 Aplicações: Gasolina, gasóleo, querosene, óleos leves, água não potável

-  **Características:**
 Potência: 4 pilas "AA" (NO incluidas)
 Tubo de succión: 457mm; Manguera de descarga: 990mm
 Volumen de entrega: 9,1 litros por minuto
 Auto-Stop: Sistema de auto-parada incorporado
 Aplicaciones: Gasolina, diésel, queroseno, aceites ligeros, agua no potable

REF		
3301	600gr	12x

 Bomba trasfega de bidons
 Bomba trasvase de bidones



 **Aplicação:** Álcool, óleo, lubrificantes, gasolina, diesel, etc
Flujo: 350ml por bombeio
Comprimento: 320-900mm

 **Aplicación:** Alcohol, aceite, lubricantes, gasolina, diesel, etc
Flujo: 350ml por bombeo
Comprimento: 320-900mm

REF			
3235	25/50/200L	700gr	12x

 Bomba manual extração
 Bomba manual extracción



 **Aplicação:**
Óleos, lubrificantes, diesel, fluidos à base de óleo

Características:
Encaixe: bidões 50 e 200L. Taxa de fluxo: 32 L/min
Velocidade: 70R / Min. Distância sucção: 3-5M
Diâmetro interno/externo: 32/25mm Comprim. máx. tubo vertical: 40"

 **Aplicación:**
Aceites, lubricantes, diesel, fluidos a base de aceite

Características:
Ajuste bidones de 50 y 200L. Velocidad flujo: 32L /min
Velocidad: 70R / Min. Distancia de succión: 3-5M
Diámetro interior / exterior: 32/25 mm. Longitud máx. tubo vertical: 40"

REF		
3281	1,16kg	10x

 Bomba com depósito 1L
 Bomba con deposito 1L

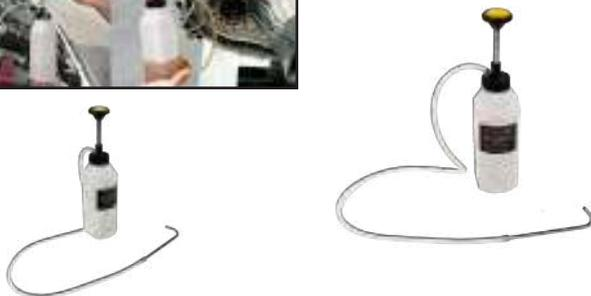

 **Descrição:** Bomba multifuncional perfeita para encher pontos de difícil acesso em veículos motorizados, corta-relvas, motosserras e outros, para trabalhos de oficina e em casa
Adequado para todos os óleos de motor, líquidos de transmissão, líquidos de travões e produtos de limpeza de uso geral
Características: Capacidade: 1L; Comprimento manqueira: 1M
AVISO: Não adequado para gasolina e outros líquidos inflamáveis

 **Descripción:** Bomba multiusos perfecta para rellenar puntos de difícil acceso en vehículos a motor, cortacéspedes, motosierras y otros trabajos en el taller y el domicilio
Adecuada para todos los aceites de motor, líquidos de transmisión, líquidos de frenos y limpiadores de uso general
Características: Capacidad: 1L; Longitud de la manguera: 1M
AVISO: No apto para gasolina y otros líquidos inflamables

REF		
3278	400gr	25x

 Bomba trasfega 12V
 Bomba trasvase 12V

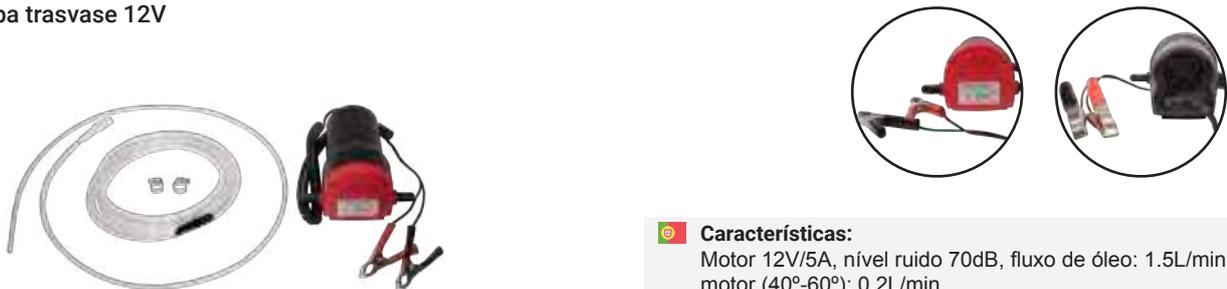

 **Características:**
Motor 12V/5A, nível ruido 70dB, fluxo de óleo: 1.5L/min, fluxo óleo motor (40°-60°): 0.2L/min

 **Características:**
Motor 12V/5A, nível ruido 70dB, flujo de aceite: 1.5L/min, flujo aceite motor (40°-60°): 0.2L/min

REF		
3285	900gr	10x

 Bomba elétrica transfega diesel 12V
 Bomba electrica transvase diesel 12V



NOTA: Risco de sobreaquecimento. Não operar por mais de 20 minutos seguidos. Caso este limite seja ultrapassado, espere 1h até voltar a funcionar

NOTA: Riesgo de sobrecalentamiento. No utilizar durante más de 20 minutos seguidos. Si se supera este límite, espere 1 hora antes de volver a utilizar el aparato

Características:

Voltagem: DC 12V

Potência: 175W

Corrente carga: 10Amps

Velocidade: 3600RPM

Fluxo: 45L/min

Comprimento máximo: 10m

Sucção máxima: 3m

Diâmetro entrada / saída: 25mm

Características:

Voltaje: DC 12V

Potencia: 175W

Corriente de carga: 10Amps

Velocidad: 3600RPM

Flujo: 45L/min

Longitud máxima: 10m

Succión máxima: 3m

Diámetro de entrada / salida: 25mm

REF

3290



7,5kg



2x

 Bomba elétrica transfega diesel 230V
 Bomba eléctrica transvase diesel 230V



Características:

Tensão: 220/240V / 50HZ

Potência nominal: 550W

Fluxo máximo: 60L/min

Sucção máxima: 5m

Manguera pistola: 4m

Tubo aspiração: 2m

Características:

Tensión: 220/240V / 50HZ

Potencia nominal: 550W

Flujo máximo: 60L/min

Succión máxima: 5m

Manguera pistola: 4m

Tubo aspiración: 2m

REF

3291



13,1kg



2x

 Bomba elétrica transfega Adblue ® 230V
 Bomba eléctrica transega Adblue ® 230V



Características:

Potência nominal: 550W

Velocidade de rotação: 2800 RPM

Caudal (l/min): 40L

Altura máxima de elevação: 10m

Altura máxima de sucção: 5m

Pressão 2.8BAR

Diâm. conector entrada / saída: 1"

Classe de proteção IP: IP55

Características:

Potencia nominal: 550W

Velocidad rotación: 2800RPM

Caudal: 40L/min

Altura máxima elevación: 10m

Altura máxima de succión: 5m

Pressão 2.8BAR

Diám. conector entrada/salida: 1"

Clase protección IP: IP55

REF

3297



11,96kg



1x

 Bomba elétrica Adblue ®
 Bomba eléctrica Adblue ®



 **Características:**
Distribui até 28L/min
Tubo sucção telescópico 850-1245mm
Para bidões metálicos: 205L, 1000L, 1250L
Mangueira: 2m
Ciclo de trabalho: 15m on 15m off
Líquidos recomendados: combustíveis, mídia à base de água, óleos leves Adblue ® def e produtos químicos selecionados de bidões metálicos
Inclui adaptador AC 100-240V e pinças da bateria de 12V

 **Características:**
Distribuye hasta 28L/min
Tubo succión telescópico 850-1245mm
Para bidones metálicos: 205L, 1000L, 1250L
Manguera: 2m
Ciclo de trabajo: 15m on 15 off
Líquidos recomendados: de combustibles, medios a base de agua aceites ligeros Adblue ® def y determinados productos químicos en bidones metálicos
Incluye adaptador AC 100-240V y pinzas de la batería de 12V

REF

3288



3kg



4x

 Bomba trasfega Adblue ®
 Bomba aspiración Adblue ®

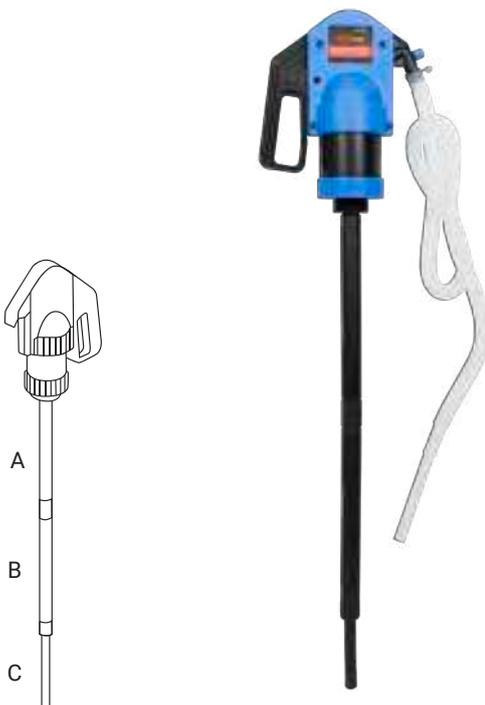

 **Características:**
Tubo extensível sucção 98cm a 120cm
Taxa de fluxo 20L por minuto
Fornecido com mangueira flexível 2m
Ferramenta de oficina rápida e eficaz
Volume de entrega: Cerca de 500cc
Faixa aplicável de temperatura: Cerca de -5°C ~ +45°C
Materiais Principais: Polypropylene, Polyethylene, Viton/FKM
Líquidos aplicáveis: AdBlue®, água, lubrificantes, líquido de lavagem do para-brisas, anticongelante, detergentes suaves, produtos químicos agrícolas etc

Tubo sucção (A+B+C) 690-980mm, (B+C) 350-640mm

 **Características:**
Tubo de aspiración extensible de 98 cm a 120 cm
Caudal de 20L por minuto
Se suministra con manguera flexible de 2m
Herramienta de taller rápida y eficaz
Volumen de entrega: Cerca de 500cc por curso
Rango de Temperatura: Cerca -5°C ~ +45°C
Materiales principales: Polypropylene, Polyethylene, Viton/FKM
Líquidos Aplicados: AdBlue®, agua, lubricantes, líquido de lavado del parabrisas, anticongelante, detergentes suaves, productos químicos agrícolas, etc

Tubo succión (A+B+C) 690-980mm, (B+C) 350-640mm

REF

3287



900gr



10x

 Bomba elétrica Diesel
 Bomba eléctrica Diesel



 **Características:**

Distribui até 28L/min
 Tubo sucção telescópico 850-1245mm
 Para bidões metálicos: 205L, 1000L, 1250L
 Mangueira: 2m
 Ciclo de trabalho: 15m on 15m off
 Líquidos recomendados: Diesel, Kerosene, Bio Diesel, Adblue ®
 soluções à base de água, anticongelante, detergentes, pesticidas,
 herbicidas, urea, óleos leves com viscosidade até 100cst
 Inclui adaptador AC 100-240V e pinças da bateria de 12V

 **Características:**

Distribuye hasta 28L/min
 Tubo succión telescópico 850-1245mm
 Para bidones metálicos: 205L, 1000L, 1250L
 Manguera: 2m
 Ciclo de trabajo: 15m on 15m off
 Líquidos recomendados: diésel, queroseno, biodiésel, Adblue ®
 soluciones a base de agua, anticongelante, detergentes, pesticidas,
 herbicidas, urea, aceites ligeros con viscosidad de hasta 100cst
 Incluye adaptador AC 100-240V y pinzas de la batería de 12V

REF

3289



3,1kg



4x

 Bomba bateria Diesel
 Bomba batería Diesel



 **Características:**

Com adaptadores de bidons 56 e 70mm
 Botão ON/OFF com indicador LED
 Equipado com fusível de proteção e bomba submersível silenciosa
 Tubo de sucção telescópico de 980-1250mm adequado para bidons
 205L e tanque IBC 1000L
 Inclui bateria de lítio 3200mAh que pode transferir até 800L diesel
 Tempo de carga: 3 horas.Caudal: 20LPM
 Fornecido com mangueira 2M e bico de distribuição manual
 Adequado para bombear diesel, óleo leve, água

 **Características:**

Con adaptadores para bidones de 56 y 70mm
 Botón ON / OFF con indicador LED
 Equipado con un fusible de protección y bomba sumergible silenciosa
 Tubo de succión telescópico de 980-1250mm adecuado para bidones
 de 205L y tanque IBC 1000L
 Incluye batería de litio 3200mAh que puede transferir hasta 800L diesel
 Tiempo de carga: 3 horas
 Tasa de flujo: 20 LPM
 Suministra con manguera 2M y boquilla dispensadora manual
 Apto para bombeo de diesel, aceite ligero, agua

REF

3295



2,75kg



4x

 Medidor fluídos digital diesel 1" 3289
 Medidor de flujo digital diesel 1" 3289



 **Características:**
Medidor digital diesel com entrada e saída: 1" npt 1" bsp
Material: pps
Intervalo fluxo: 5-50gpm (18,9 190lpm)
Precisão: ± 0,5%
Erro de repetibilidade: 0.1%
Classe de pressão: 10BAR

 **Características:**
Medidor digital diesel de entrada y salida: 1" npt 1" bsp
Material: pps
Rango de caudal: 5-50gpm (18,9 190lpm)
Precisión: ± 0,5%
Error de repetibilidad: 0,1%
Clase de presión: 10BAR

REF		
3282	200gr	30x

 Medidor fluídos digital Adblue ® 3296
 Medidor de flujo digital adblue ® 3296



 **Características:**
Para medidor de fluxo digital Adblue
Entrada e Saída: 1" bsp
Material do corpo: pps
Intervalo de fluxo: 5-50gpm (18,9-190lpm)
Precisão: ±0,5%
Erro de repetibilidade: 0.1%
Classe de pressão: 10BAR

 **Características:**
Para medidor de flujo digital de Adblue
Entrada y salida: 1" bsp
Material del cuerpo: pps
Rango de caudal: 5-50gpm (18,9-190lpm)
Precisión: ±0,5%
Error de repetibilidad: 0,1%
Clase de presión: 10BAR

REF		
3284	350gr	30x

 Medidor de fluídos mecânico 3290/3291
 Medidor de flujo mecanico 3290/3291



 **Características:**
Mecanismo: Disco oscilante
Fluxo: 20-80 (5+21 GPM) litros/min
Pressão do trabalho: 0.1 - 3.5 (1,45+50PSI) BAR
Temperatura de funcionamento: -10 + 50°C
Resistência ao fluxo (a 80 L/min de óleo diesel): 0.3 BAR
Precisão após configuração: ± 1%
Indicador parcial: max 999 L
Indicador total: max 999999 L
Resolução: 0,1
Conexões: 1" G (BSP)

 **Características:**
Mecanismo: disco oscilante
Flujo: 20-80 (5+21 GPM) litros/min
Presión de trabajo: 0.1 - 3.5 (1,45+50PSI) BAR
Temperatura de funcionamiento: -10 + 50°C
Resistencia al flujo (a 80 L/ min de diesel): 0.3 BAR
Precisión después configuración: ± 1%
Indicador parcial: máximo 999 L
Indicador total: máximo 999999 L
Resolución: 0,1
Conexiones: 1" G (BSP)

REF		
3283	1,9kg	10x

 Medidor fluídos digital diesel 3/4" 3290/3291/3293/3294
 Medidor de flujo digital diesel 3/4" 3290/3291/3293/3294



 **Características:**
Medidor digital diesel com entrada e saída: 3/4" npt 3/4" bsp
Material: pps
Gama de fluxo: 5-50gpm (18,9 190lpm)
Precisão: ± 0,5%
Erro de repetibilidade: 0.1%
Classe de pressão: 10BAR

 **Características:**
Medidor digital diesel de entrada y salida: 3/4" npt 3/4" bsp
Material: pps
Rango de caudal: 5-50gpm (18,9 190lpm)
Precisión: ± 0,5%
Error de repetibilidad: 0,1%
Clase de presión: 10BAR

REF		
3298	300gr	30x

-  Medidor fluídos digital diesel 1" 3290/3291
 Medidor de flujo digital diesel 1" 3290/3291



 **Descrição:** Medidor eletrónico 1" adequado para diesel ou biodiesel b30 indica e contabiliza até 9999 litros

Características:

10-100L/min
 Entrada 1" bspf
 Pressão máxima 290 psi (20 BAR)

 **Descripción:** Medidor electrónico 1" apto para diésel o biodiésel b30 muestra y cuenta hasta 9999 litros

Características:

10-100L/min
 Entrada de 1" bspf
 Presión máxima 290 psi (20 BAR)

REF



3299

750gr

20x

-  Tanque transporte Adblue ® 100L 12V
 Tanque transporte Adblue ® 100L 12V



 **Características:**

Tanque 100L Adblue 340x530x1050mm
 Com adaptadores AC/DC
 18L/m
 Com pistola manual

 **Características:**

Depósito Adblue 100L 340x530x1050mm
 Con adaptadores AC/DC
 18L/m
 Con pistola de mano

NOTA: Risco de sobreaquecimento. Não operar por mais de 20 minutos seguidos. Caso este limite seja ultrapassado, espere 1h até voltar a funcionar

NOTA: Riesgo de sobrecalentamiento. No utilizar durante más de 20 minutos seguidos. Si se supera este límite, espere 1 hora antes de volver a utilizar el aparato

REF



3296

16,12kg

1x

 Tanque Diesel 12V 210L
 Tanque Diesel 12V 210L



NOTA: Risco de superaquecimento. Não operar por mais de 20 minutos seguidos. Caso este limite seja ultrapassado, espere 1h até voltar a funcionar

NOTA: Riesgo de sobrecalentamiento. No utilizar durante más de 20 minutos seguidos. Si se supera este límite, espere 1 hora antes de volver a utilizar el aparato

 **Características:**
Capacidade tanque: 210L
Fluxo: 40 litro / minuto
Combustível: Diesel
Voltagem: 12V DC
Tampa de enchimento: Bloqueável
Manguera de entrega: de 4 M 3/4"
Cabo: 4M com pinças
Medidas: 800 * 660 * 625mm
Material: Polietileno

 **Características:**
Capacidad del tanque: 210L
Flujo: 40 litros / minuto
Combustible: Diesel
Voltaje: 12V DC
Tapón de llenado con cerradura
Manguera de entrega: 4 M 3/4"
Cable: 4M
Medidas: 800 * 660 * 625mm
Material: Polietileno

REF

3293



31kg



1x

 Tanque Diesel 12V 400L
 Tanque Diesel 12V 400L



NOTA: Risco de superaquecimento. Não operar por mais de 20 minutos seguidos. Caso este limite seja ultrapassado, espere 1h até voltar a funcionar

NOTA: Riesgo de sobrecalentamiento. No utilizar durante más de 20 minutos seguidos. Si se supera este límite, espere 1 hora antes de volver a utilizar el aparato

 **Características:**
Capacidade tanque: 400L
Fluxo: 40 litros / minuto
Combustível: Diesel
Voltagem: 12 V DC
Tampa de enchimento: bloqueável
Manguera de entrega: de 4 M 3/4"
Cabo: 4M com pinças
Medidas: 1110 * 960 * 660mm
Material: Polietileno

 **Características:**
Capacidad del tanque: 400L
Flujo: 40 litros / minuto
Combustible: Diesel
Voltaje: 12 V DC
Tapón de llenado con cerradura
Manguera de entrega: 4 M 3/4"
Cable: 4M
Medidas: 1110 * 960 * 660 mm
Material: Polietileno

REF

3294



45kg



1x

 Tanque diesel/gasolina 12V 200L

 Tanque diesel/gasolina 12V 200L



NOTA: Risco de sobreaquecimento. Não operar por mais de 20 minutos seguidos. Caso este limite seja ultrapassado, espere 1h até voltar a funcionar

NOTA: Riesgo de sobrecalentamiento. No utilizar durante más de 20 minutos seguidos. Si se supera este límite, espere 1 hora antes de volver a utilizar el aparato

 **Descrição:**

Geral: Todas as unidades de transferência vêm equipadas de série com uma pistola de fecho automático, todas as bombas têm um ciclo de trabalho de 30 minutos de distribuição contínua

Depósitos: Fabricados em polietileno resistente ao impacto, com estabilização UV, de cor vermelha e equipados com tampa e ventilador

Manguera: 4 m x 3/4" fornecida

Especificações:

Capacidade Tanque: 200L

Comprimento: 850mm

Largura: 700mm

Altura: 645mm

 **Descripción:**

General: Todas las unidades de transferencia vienen equipadas de serie con una pistola de cierre automático, todas las bombas tienen un ciclo de trabajo de dispensación continua de 30 minutos

Depósitos: Fabricados en polietileno resistente a los impactos con estabilización UV, de color rojo y equipados con tapa y ventilador

Manguera: 4 m x 3/4" suministrada

Especificaciones:

Capacidad Deposito: 200L

Longitud: 850mm

Ancho: 700mm

Altura: 645mm

REF



28kg



72x

 Almotolia de óleo 1/4" 125CC

 Aceitera 1/4" 125CC



Tubo flexível
Tubo flexible



REF 3214T

REF



225gr



72x

 Almotolia de óleo 1/2" 250CC

 Aceitera 1/2" 250CC



Tubo flexível
Tubo flexible



REF 3212T

REF



303gr



72x

 Seringa de óleo

 Engrasadora manual



 **Composição:** Com manguera flexível transparente de 270mm

 **Composición:** Con manguera flexible transparente de 270mm

REF

500CC
1000CC800gr
880gr20x
25x

 Seringa de óleo 1500CC
 Jeringa de aceite 1500CC



 **Aplicação:** Adequado para usar com óleo transmissão e diferencial
Pode ser usado com líquido de travões e anticongelantes
Pode ser usado também para AdBlue
Capacidade: 1,5L

 **Aplicación:** Adequado para usar con aceite transmisión y diferencial
Puede ser utilizado con líquido de frenos y anticongelantes
También se puede utilizar para AdBlue
Capacidad: 1,5L

REF		
3232	820gr	10x

 Seringa de óleo 200CC
 Jeringa manual 200CC



 **Aplicação:** Pode ser usado com líquidos de travões

 **Aplicación:** Puede ser usado con líquidos de frenos

REF		
3233	260gr	25x

 Seringa para sangrar bomba de combustível 1500CC
 Jeringa de fluidos 1500CC



 **Aplicação:** Adaptadores Opel/PSA, e (2x) adaptadores universais

 **Aplicación:** Adaptadores Opel/PSA, y (2x) adaptadores universales

REF		
3234	1kg	10x

 Conjunto de 4 varetas óleo Mercedes
 Conjunto de 4 varillas aceite Mercedes



 **Aplicação:** (1x) Vareta vermelha 1200mm: tansmissão 722.6
(1x) Vareta verde 920mm: tansmissões 716.5, 722.7, 722.800 (Classe B)
(1x) Vareta amarela 930mm: motores M137, 111.945, 611, 612, 613
(1x) Vareta azul 930mm: motores 112,113,646,647,648

 **Aplicación:** (1x) Varilla roja 1200mm: tansmisión 722.6
(1x) Varilla verde 920mm: tansmisiones 716.5, 722.7, 722.800 (Clase B)
(1x) Varilla amarilla 930mm: motores M137, 111.945, 611, 612, 613
(1x) Varilla azul 930mm: motores M112,113,646,647,648

REF		
9750	375gr	100x

 Vareta óleo motor Audi
 Varilla aceite motor Audi

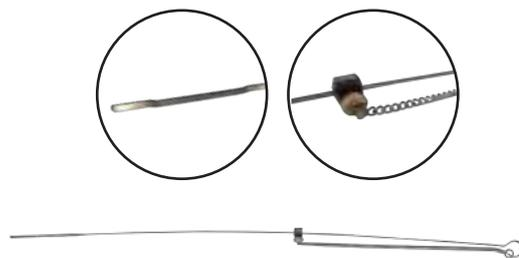

	2.0TFSI, 3.2FSI, 3.0, 4.3FSI, 2.0TDI CR
---	---

REF			
9755	710mm	33gr	100x

 Vareta óleo transmissão Audi
 Varilla aceite transmisión Audi

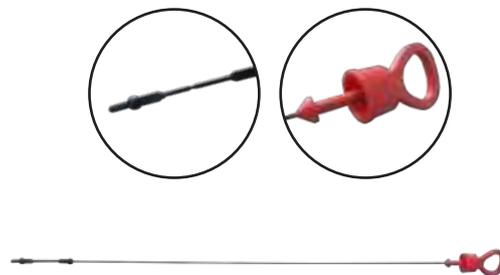

	Audi
---	------

REF			
9756	695mm	300gr	1x

 Bomba encher óleo nas transmissões 15 adaptadores
 Kit bomba llenado sistema transmisión 15 adaptadores

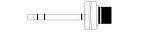

1x		ATF101: Ford 1/8 - 27 (NPT)
1x		ATF102: BMW, Honda, Nissan, etc
1x		ATF103: VAG, Škoda
1x		ATF104: VAG, Porsche
1x		ATF105: VW/Audi, Mini cooper M10x1.0
1x		ATF106: VAG DS M24x1.5
1x		ATF107: VAG CVT M22x1.5
1x		ATF108: VW, Škoda M18x1.5
1x		ATF109: Mercedes M12x1.5
1x		ATF110: VAG, Škoda M30x1.5
1x		ATF111:300mm Honda, Hyundai, KIA, etc
1x		ATF112: Volvo 5/16 - 24 (UNF)
1x		ATF113: Toyota, Lexus M18x1.5
1x		114: Nissan, Infinity M8x1.0
1x		ATF115: VW Passat

 **Características:**
 Dimensões: 260×370×595mm
 Capacidade 7,5L

 **Características:**
 Dimensiones: 260×370×595mm
 Capacidad: 7,5L

REF			
5350	7,5L	4kg	4x

 Alavanca filtro gasóleo 2.0 TDI common rail
 Palanca filtro diesel 2.0 TDI common rail



 **Aplicação:** Motores common rail TDI com filtros diesel UFI

 **Aplicación:** Motores common rail TDI con filtros diesel UFI

REF		
6290	487gr	40x

 Kit 2 peças retirar filtros combustível Opel
 Juego 2 piezas extraer filtros combustible Opel



Chvrolet 2.0 VDCI / Captiva, Epica, Citroën Relay, Peugeot Boxer 2.0, 2.2, 2.8, 3.0 HDI, Fiat Ducato 2.0, 2.2, 2.3, 2.8, 3.0 JTD. Fiat 1.3 JTD, Idea, Panda II, Punto II, Fiat 1.9 JTD, Idea, Multipla, Sedici, 2.0 JTD. Lancia 1.3 MJTD, Musa, Ypsilon; Saab 9-3 1.9 TiD Suzuki 1.3 DDiS, Splash, Swift, SX4; Opel 1.3 CDTi / Agila, Astra, Corsa, Combo, Meriva, Tigra, 1.9 CDTi Astra, Signum, Vectra, Zafira

REF			
5325	1/2"	400gr	1x

 Kit 2 peças retirar filtros combustível universal
 Juego 2 piezas extraer filtros combustible universal



REF			
5330	1/2"	354gr	24x

 Chave ajustável para tanque de combustível
 Llave ajustable para tanque combustible



 **Aplicação:** Retira a fêmea da bomba do tanque de combustível
 **Aplicación:** Retira la hembra da bomba del depósito de combustible

REF				
5315	24mm	75-160mm	575gr	20x

 Chave ajustável fêmea tanque de combustível
 Llave ajustable hembra tanque combustible



 Funil plástico bico flexível
 Embudo plástico



 **Aplicação:** Retira a fêmea da bomba do tanque de combustível

 **Aplicación:** Retira la hembra da bomba del depósito de combustible

REF				
5318	15mm	89-170mm	900gr	10x

 **Descrição:** Com bico flexível amovível de plástico

 **Descripción:** Con boquilla flexible extraíble plástico

REF			
8031	950ml	105gr	100x

 Chave bomba combustível VAG 120mm
 Llave bomba combustible VAG 120mm



	Audi A8, Touareg (03), VW Touran (04), Passat (06), Passat CC (09), EOS (06), Tiguan (08), Golf Plus (05), Golf (04)
	T10202 (VAG 3087)

REF			
5316	120mm	690gr	30x

 Funil anti-derrame com kit acessórios 15 peças
 Embudo sin derrame con kit accesorios 15 piezas



2x		45°
1x		130mm
4x		
5x		
1x		
1x		
1x		

 **Aplicação:**
Elimina bolsas de ar presas que geralmente causam um sistema de refrigeração irregular e mau desempenho do radiador. Controla a quantidade adequada de líquido de refrigeração que entra no sistema e permite o enchimento não assistido

 **Aplicación:**
Elimina las bolsas de aire atrapadas que generalmente causan un sistema de enfriamiento irregular y un bajo rendimiento del radiador. Controla la cantidad adecuada de refrigerante que ingresa al sistema y permite el llenado desatendido

REF				
8037	180mm	195mm	625gr	8x

 Funil com adaptadores 7 peças
 Embudo con adaptadores 7 piezas



1x		M37x3.0: Lexus, Toyota
1x		M42x4.5: Subaru
1x		M32x3.5: Honda, Nissan
1x		M35x4.0: Mazda
1x		VW Sharan, Ford Galaxy, Seat Alhambra, etc

REF

8035



1L



3,1kg



1x

 Funil óleo com adaptadores 8 peças
 Embudo aceite con adaptadores 8 piezas

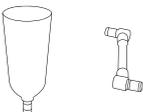

1x		
1x		Audi, BMW, Mercedes, Porsche, Volvo, VW
1x		M32 - Acura, Dodge, Ford, Honda, Jaguar, Jeep, Land Rover, Mazda, Nissan
1x		M35 - Ford, Jaguar, Land Rover, Mazda
1x		M37 - Lotus, Pontiac, Scion, Toyota
1x		M42 - Subaru
1x		Toyota, Lexus

REF

8036



2L



2,75kg



4x

 Jogo anilhas bujões e machos para carter 114 peças
 Juego reparación sistema de aceite 114 piezas



Bujão / Tapón M13x1.5P



REF 104013X1.5

Bujão / Tapón M13x1.25P



REF 104013X1.25

Anilha / arandela M22



REF 1040M22

Anilha / arandela M20



REF 1040M20

Anilha / arandela M17



REF 1040M17

Anilha / arandela M15



REF 1040M15

Anilha / arandela M13



REF 1040M13

Macho 22x1.5P



REF 1040M22X1.5

Macho 20x1.5P



REF 1040M20X1.5

Macho 17x1.5P



REF 1040M17X1.5

Macho 15x1.5P



REF 1040M15X1.5

Macho 13x1.5P



REF 1040M13X1.5

Macho 13x1.25P

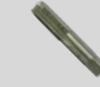

REF 1040M13X1.25

Bujão / Tapón M22x1.5P



REF 104022X1.5

Composição/Composición:

(36x) Bujões/Tapones: (6x) M13x1.25, (6x) M13x1.5 (6x) M15x1.5 (6x) M17x1.5, (6x) M20x1.5, (6x) M22x1.5
 (6x) Machos de roscar/Machos de roscar: M13x1.25, M13x1.5, M15x1.5, M17x1.5 M20x1.5, M22x1.5
 (72x) Anilhas/ Arandelas: (12x) M13x1.25, (12x) M13x1.5, (12x) M15x1.5, (12x) M17x1.5, (12x) M20x1.5, (12x) M22x1.5

REF

1040



4kg



2x

 **Jogo fresa retificar superfície encosto anilha do bujão**
 **Juego escariador rectificar superficie respaldo arandela tapón**



	Alfa Romeo, Audi, Cadillac, Chevrolet Daewoo, Chrysler, Dodge, Fiat, Ford, Honda, Hyundai, Jaguar, Jeep, Kia, Land Rover, Mazda, Mercedes, MG, Mini, Mitsubishi, Opel/Vauxhall, Porsche, Rover, Saab, Seat, Škoda, Suzuki, Volkswagen, Volvo
---	--

 **Aplicação:** Aperte o adaptador de rosca apropriado do cárter e use-o como retificador para retificar a superfície do vedante do cárter assim como a rosca
Composição:
(2x) Adaptadores de rosca
M14x1.5 mm para fio de roscas de bujão
M15x1.5 mm para fio de roscas de bujões grandes dimensões

 **Aplicación:** Apriete el cortador apropiado del cárter y úselo como rectificador para rectificar el área del sello del cárter
Composición:
(2x) Cortantes
M14x1.5 mm para hilo de roscas de tapón estándar
M15x1.5 mm para hilo de roscas de tapones de gran tamaño

REF		
1043	600gr	1x

 **Kit montagem e desmontagem bujões plástico**
 **Kit montaje y desmontaje tornillos aceite plástico**

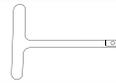

1x		3/8"
1x		1/4" x 3/8"
1x		1/4" - 10mm BMW
1x		3/8" - PSA
1x		1/4" - VAG

 **Aplicação:** Bits especiais para montagem e desmontagem dos bujões de óleo plástico do reservatório

 **Aplicación:** Puntas especiales para el montaje y desmontaje de tapones de aceite de depósitos de plástico

REF			
7010	1/4" - 3/8"	262gr	40x

 **Íman para remoção bujão de carter**
 **Imán para remoción tapón de carter**



 **Descrição:** Ferramenta de remoção magnética para remover com segurança o bujão do depósito, uma vez solto, evitando o contato com óleo quente

Aplicação: Universal

 **Descripción:** Herramienta de extracción magnética para quitar de forma segura el tapón del tanque, una vez suelto, evitando el contacto con aceite caliente

Aplicación: Universal

REF		
2337	130gr	100x

 **Chave para bujão 8x10mm**
 **Llave para tapón de carter 8x10mm**

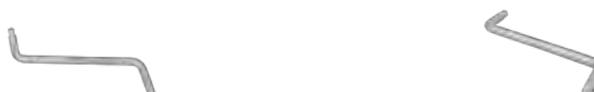

REF		
0810	235gr	40x

-  Adaptador para bujão plástico hexagonal 10mm
 Adaptador para tapón plástico hexagonal 10mm



VW, Audi, Škoda, Seat 1.2, 1.4, 1.8, 2.0 TFSI, 1.6, 2.0 TDI

 **Descrição:** Necessário para a remoção e instalação adequada do bujão de óleo de plástico especial. **Tamanho:** Hexagonal 10mm

 **Descripción:** Requerimientos para el retiro y la instalación adecuada del tapón de aceite plástico especial. **Tamaño:** Hexagonal 10mm

REF			
1041	10mm	15gr	1x

-  Adaptador bujão plástico hexagonal 17mm (3/8")
 Adatador tapón plástico hexagonal 17mm (3/8")



VAG, Škoda, Seat 1.2/1.4/1.8/2.0 TFSI (bujões/tapones), 1.6/2.0 TDI (tampa de encaixe/ tapa de enchufe)

 **Descrição:** Necessário para a remoção e instalação adequada do bujão de óleo plástico especial. **Tamanho:** Hexagonal 17mm, 3/8"

 **Descripción:** Necesario para la extracción y instalación adecuada del tapón de aceite plástico especial. **Tamaño:** Hexagonal 17mm, 3/8"

REF			
1042	17mm (3/8")	34gr	1x

-  Ferramenta remover/installar bujão carter VAG
 Herramienta remoción/instalación tapón carter VAG



 **Aplicação:** VAG 2.0 4 cil. nos motores de injeção direta Turbo GEN III - Golf Mk VII (7), Audi, Seat Leon (inferior 2013). Esta ferramenta é utilizada também para a tampa da árvore de cames nos motores mais recentes diesel com dupla árvore de cames 1.6 e 2.0 TDi da gama VAG

Código OEM: T10549

 **Aplicación:** VAG 2.0 4 cil. en motores de inyección directa Turbo GEN III - Golf Mk VII (7), Audi, Seat Leon (inferior 2013). Esta herramienta también se utiliza para la cubierta del árbol de levas en los últimos motores diésel de árbol de levas gemelos TDi 1.6 y 2.0 en la gama VAG

Código OEM: T10549

REF			
0811		45gr	100x

-  Ferramenta remover conector MAF VAG/Porsche
 Herramienta remover conector MAF VAG/Porsche



 **Aplicação:** Para remoção segura e adequada da maioria dos conectores VAG "push & pull", por ex. conector elétrico no sensor de fluxo de ar de massa (MAF), sensor de pressão (MAP), pacote de bobina de ignição, farol, luz de nevoeiro, sensor de nível, etc

 **Aplicación:** Para la extracción segura y adecuada de la mayoría de los conectores VAG push & pull, por Ej. conector eléctrico en el sensor de flujo de masa de aire (MAF), sensor de presión (MAP), paquete de bobina de encendido, faro, luz antiniebla, sensor de nivel, etc

REF			
0812		50gr	100x

 Jogo 20 peças chaves para bujão do óleo
 Juego 20 piezas llaves punta tornillos carter



7x			8,9,10,12,13,14,17mm
9x			5/16", 3/8", 7,8,10,11,12,13,14mm
1x			10mm
1x			10mm
1x			M16
1x			3/8"

REF	◇	⚖️	📦
7008	5/16" - 3/8"	1,4kg	10x

 Jogo 20 peças chaves para bujão do óleo
 Juego 20 piezas llaves punta tornillos carter



6x			8,9,10,12,14,17mm
8x			5/16", 7, 8, 10, 11, 12, 13, 14mm
1x			10mm
1x			10mm
1x			M16
1x			VAG
1x			T45
1x			200mm

REF	◇	⚖️	📦
7009	3/8"	1,56kg	10x

 Kit especial bujões carter 63 peças
 Kit especial tapones aceite 63 piezas



<p>3x Bujão carter M14x1.5mm 3x Tapón aceite M14x1.5</p>    <p>REF 7000-01</p>	<p>1x Bujão carter M20x1.5mm 1x Tapón aceite M20x1.5mm</p>  <p>REF 7000-02</p>	<p>1x Bujão carter M18x1.5mm 1x Tapón aceite M18x1.5mm</p>  <p>REF 7000-03</p>		
<p>3x Bujão carter M16x1.5mm 3x Tapón aceite M16x1.5mm</p>    <p>REF 7000-04</p>	<p>1x Bujão carter M22x1.5mm 1x Tapón aceite M22x1.5mm</p>  <p>REF 7000-05</p>	<p>2x Bujão carter M14x1.25mm 2x Tapón aceite M14x1.25mm</p>   <p>REF 7000-06</p>		
<p>1x Bujão carter M10x1.25mm 1x Tapón aceite M10x1.25mm</p>  <p>REF 7000-07</p>	<p>1x Bujão carter m12x1.5mm 1x Tapón aceite M12x1.5mm</p>  <p>REF 7000-08</p>	<p>25x Anilha cobre 10Ø 25x Arandela cobre 10Ø</p>  <p>REF 7000-09</p>	<p>20x Anilha cobre 12Ø 20x Arandela cobre 12Ø</p>  <p>REF 7000-10</p>	<p>5x Vedante 1/4"Ø 5x Rententor 1/4"Ø</p>  <p>REF 7000-11</p>

 **Composição:**
 (3x) M14 x 1,5mm, para VW - Audi - Ford - Opel - Mercedes - Fiat JTD
 (1x) M20 x 1,5mm, para Fiat - Alfa - Lancia
 (1x) M18 x 1,5mm, para PSA - Renault - Volvo - Toyota - Mitsubishi
 (3x) M16 x 1,5mm, para PSA - Renault - Volvo
 (1x) M22 x 1,5mm, para PSA - Fiat
 (2x) M14 x 1,25mm, para PSA Diesel HDI
 (1x) M10 x 1,25mm, para PSA HDI
 (1x) M12 x 1,5mm, para Renault - Toyota - Nissan - Mercedes
 (25x) Anilhas de cobre Ø10
 (5x) Vedantes Ø1/4"
 (20x) Anilhas de cobre Ø12

 **Composición:**
 (3x) M14 x 1,5mm, para VW - Audi - Ford - Opel - Mercedes - Fiat JTD
 (1x) M20 x 1,5mm, para Fiat - Alfa - Lancia
 (1x) M18 x 1,5mm, para PSA - Renault - Volvo - Toyota - Mitsubishi
 (3x) M16 x 1,5mm, para PSA - Renault - Volvo
 (1x) M22 x 1,5mm, para PSA - Fiat
 (2x) M14 x 1,25mm, para PSA Diesel HDI
 (1x) M10 x 1,25mm, para PSA HDI
 (1x) M12 x 1,5mm, para Renault - Toyota - Nissan - Mercedes
 (25x) Arandelas de cobre Ø10
 (5x) Sellos de goma Ø1/4"
 (20x) Arandelas de cobre Ø12

REF	⚖️	📦
7000	740gr	20x

 Jogo master 33pcs para bujões óleo
 Juego de tapón de drenaje de aceite 33 piezas



 **Descrição:**
 Adequado para remover o bujão de drenagem de óleo de motores, caixas de velocidades e eixos traseiros
 Jogo master para a maioria dos automóveis populares

 **Descripción:**
 Adequado para extraer el tapón de vaciado de aceite de motores, cajas de cambio y ejes traseros
 Juego para la mayoría de los coches más populares

1x		3/8": 6"
1x		3/8": 3"
1x		3/8": 200mm
9x		3/8": 5/16", 3/8", 7mm, 8mm, 10mm, 11mm, 12mm, 13mm, 14mm
7x		3/8": 8mm, 9mm, 10mm, 12mm, 13mm, 14mm, 17mm
1x		M16
1x		T45
1x		10mm
1x		10mm
1x		Carros japoneses / Coches japoneses
3x		Ford
1x		Ford/PSA
1x		Mercedes
1x		DAF/MAN
1x		BMW
1x		GM
1x		VAG

REF

7007



2,4kg



10x

 Kit remoção molas pressão intermédias das válvulas BMW / MINI / PSA
 Alicates de instalacion y extraccion de resorte de presión BMW / MINI / PSA



	1.4 1.6
	1.4: N12 B14, N12 B14AB 1.6: N12 B16A, N16 B16A, N16 B16A/M0, N16 B16K0, N16 B16M0, N16 B16U0, N18, N18 B16A, N18 B16A/M0, N18 B16C, N18 B16C/TO, N18 B16M0, 5FE (EP6CDT), 5FE (EP6CDTM), 5FN (EP6CDT), 5FP (EP6), 5FV (EP6CDT), 5FW (EP6), EP6 (5FW), EP6CDT (5FA), EP6CDT (5FE), EP6CDT (5FM), EP6CDT (5FN), EP6CDT (5FV)
	BMW: Mini One, Clubman, Clubvan Countryman, Coupe, Paceman, Roadster Citroën: C3 Picasso, C4, C4 Picasso, C5, DS3, DS4, DS5 Peugeot: 207, 208, 3008, 308, 5008, 508, RCZ
	11 9 571, 0197-3B1, 11 9 572, 0197-3B2, 11 9 573

 **Descrição:** Especialmente concebido para remover e instalar a mola de pressão do eixo intermédio

 **Descripción:** Especialmente diseñado para desmontar e instalar el muelle de presión del eje intermedio

REF

2107



5,3kg



2x

 Despolidor de cilindros 19-69mm (pedras 28.8mm)
 Pulidora cilindros 19-69mm (rocas 28.8mm)



Pedras 28mm
Rocas recambio 28mm

REF 7013

REF			
7014	16-69mm	97gr	72x

 Despolidor de cilindros 32-89mm (pedras 50mm)
 Pulidora cilindros 32-89mm (rocas 50mm)



Pedras 50mm
Rocas recambio 50mm

REF 7133

REF			
7015	32-89mm	111gr	72x

 Despolidor cilindros 50-178mm (pedras 100mm)
 Pulidora cilindros 50-178mm (rocas 100mm)



Pedras grão fino 100mm
Rocas recambio 100mm

REF 7134

Pedras gr. médio 100mm
Rocas recambio 100mm

REF 7137

REF			
7020	50-178mm	400gr	20x

 Despolidor de cilindros 89-370mm (4x pedras 100mm)
 Pulidora cilindros 89-370mm (4x rocas 100mm)



Pedras 89-370mm
Rocas 89-370mm

REF 7138

Pedras grão fino 100mm
Rocas recambio 100mm

REF 7134

Pedras gr. médio 100mm
Rocas recambio 100mm

REF 7137

REF			
7025	89-370mm	720gr	25x

 Despolidor cilindros 51-250mm
 Pulidora cilindros 51-250mm



Pedras Grão fino 100mm
Rocas recambio 100mm

REF 7134

Pedras gr. médio 100mm
Rocas recambio 100mm

REF 7137

REF			
7030	51-250mm	425gr	40x

 Chave de velas 3/8" 14x250mm (bihexagonal)
 Llave de bujias 3/8" 14x250mm (bihexagonal)



	Renault
---	---------

REF			
1581	250mm	237gr	40x

Chave de velas 3/8" 14x90mm magnética (bihexagonal)
 Llave de bujias 3/8" 14x90mm imantada (bihexagonal)



	BMW, Mini, Citroën C5 2.0i, Nissan Micra Mercedes (M156); Peugeot 207/307, Renault Modus, Twingo, Clio, Kangoo 1.2 16v
--	--

REF	↕	📏	📦
2015	90mm	108gr	60x

Chave de velas 3/8" 16x250mm (bihexagonal)
 Llave de bujias 3/8" 16x250mm (bihexagonal)



	Opel, VW, Mercedes
	BMW, Kawasaki, Yamaha, Honda, Suzuki, Ducat

REF	↕	📏	📦
2016	250mm	331gr	48x

Chave de velas 3/8" 21x250mm (bihexagonal)
 Llave para bujias 3/8" 21x250mm (bihexagonal)



Características:
 3/8" Extra Longo
 Tamanho: 21mm-12PT (BI-HEX)
 Comprimento: 250mm
 Material: CR-V

Características:
 3/8" Extra Largo
 Tamaño: 21mm-12PT (BI-HEX)
 Longitud: 250mm
 Material: CR-V

REF	↕	📏	📦
2021	250mm	600gr	20x

Chave de velas 3/8" 18x250mm (bihexagonal)
 Llave para bujias 3/8" 18x250mm (bihexagonal)



	Motos BMW, Kawasaki, Yamaha, Honda, Suzuki
--	--

REF	↕	📏	📦
2018	250mm	400gr	36x

Chave de velas 3/8" com cardan 97mm
 Llave de bujias 3/8" con cardan 97mm



REF	⊕	↕	📏	📦
381214	14mm	97mm	95gr	48x
381216	16mm	97mm	125gr	48x

Chave de velas 3/8" (hexagonal)
 Llave para bujias 3/8" (hexagonal)



REF	⊕	↕	📏	📦
13816	16mm	62mm	130gr	1x
13821	21mm	62mm	100gr	1x

Chave de velas 3/8" com cardan 310mm
Llave de bujias 3/8" con cardan 310mm



REF	⊖	ℓ	⚖	📄
381214L	14mm	310mm	291gr	48x
381216L	16mm	310mm	302gr	48x

Chave de velas 1/2" (hexagonal)
Llave para bujias 1/2" (hexagonal)



REF	⊖	ℓ	⚖	📄
12016	16mm	65mm	110gr	100x
12021	21mm	65mm	150gr	1x

Chave de velas 1/2" articulada em T (hexagonal)
Llave para bujias 1/2" articulada en T (hexagonal)



REF	⊖	ℓ	⚖	📄
13016	16mm	230mm	229gr	48x
13021	21mm	230mm	250gr	1x

Chave especial 17mm válvulas Mercedes
Llave especial 17mm válvulas Mercedes



REF	⚖	📄
6138	150gr	96x

Chave 1/2" XZN M16H impacto
Llave de vaso 1/2" XZN M16H impacto



	Caixa de velocidades / Caja de cambios Audi A3/A4/A6, VW Golf IV
--	---

REF	⚖	📄
12116	170gr	100x

Jogo 2 peças esmerilador de válvulas
Juego 2 piezas esmeriladoras de válvulas



⚖	Diâmetro ventosas: 16, 20, 29, 35mm	
📄	Diâmetro ventosas: 16, 20, 29, 35mm	
REF	⚖	📄
2150	152gr	72x

 **Máquina pneumática rodar válvulas**
 **Lapeador neumático de válvulas**



Características:
 Ventosas: 16, 20, 30, 35, 45mm, Golpes por min.: 800BPM;
 Consumo médio de ar: 1,77CFM (50L/min)
 Comprimento: 289,1mm, Pressão do ar: 90psi (6,2kg/cm²)
 Entrada de ar: 1/4", Tamanho mínimo mangueira: 1/4" (6,35mm)

Características:
 Ventosas: 16, 20, 30, 35, 45 mm, Golpes por minuto: 800BPM
 Consumo medio de aire: 1,77CFM (50L/min)
 Longitud: 289,1mm, Presión de aire: 90 psi (6,2 kg/cm²)
 Entrada de aire: 1/4", Tamaño minimo mangueira: 1/4" (6.35mm)

REF



2kg



5x

 **Ferramenta para berbequim rodar válvulas**
 **Herramienta para taladro rodar válvulas**

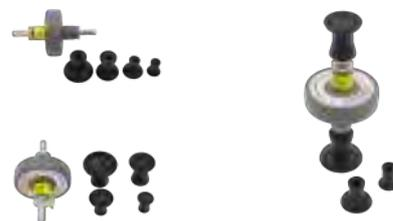

Características:
 Eixo: 8mm
 Velocidade mínima: 1000rpm
 Velocidade máxima: 1250rpm
 Ventosas: 20, 30, 35, 45mm

Aplicação:
 Facilita a inserção das válvulas
 Mudança automática de direção
 Para uso com pasta de moagem fina

Características:
 Eje: 8mm
 Velocidad mínima: 1000rpm
 Velocidad máxima: 1250rpm
 Ventosas: 20, 30, 35, 45mm

Aplicación:
 Facilita la inserción de válvulas
 Cambio automático de dirección
 Para usar con pasta de amolar fina

REF



1250rpm



275gr



20x

 **Kit remoção molas válvulas ar comprimido 15 peças**
 **Kit remoción muelles valvulas aire comprimido 15 piezas**



Características:
 Evita que a válvula do motor caia no corpo devido à contrapressão, causada pelo ar fornecido através de uma rosca de velas
 Adequado para velas M14 x 1,25 e M18 x 1,5
 Acessórios de extensão
 Funciona com punho em T de 10 mm (3/8") ou com roquete

Características:
 Evita que la válvula del motor caiga dentro del cuerpo debido a la contrapresión causada por el aire suministrado a través de la rosca de una bujía
 Apto para bujías M14 x 1,25 y M18 x 1,5
 Accesorios de extensión
 Funciona con un mango en T de 10 mm (3/8") o una carraca

REF



4,3kg



2x

 **Kit instalar/remover chaveta retenção válvula**
 **Kit montaje/remocion retenedor keeper**



Aplicação:
 Remove e instala rapidamente as chavetas das válvulas na maioria dos motores de válvulas suspensas com válvulas de 4,5 a 7,5 mm e 5/16" a 3/8"
 Medida inferior funciona em motores Toyota de quatro cilindros e Chrysler New World

Aplicación:
 Quita e instala rápidamente llaves de válvula en la mayoría de los motores de válvulas en cabeza con válvulas de 4,5 a 7,5 mm y de 5/16" a 3/8"
 Nuevo tamaño inferior que funciona en motores Toyota de cuatro cilindros y Chrysler New World

REF



1,1kg



10x

 Jogo desmontador válvulas
 Juego desmontador válvulas



1x		
5x		16, 19, 23, 25, 30mm
3x		70, 110, 120mm
1x		
1x		
1x		

REF		
2105	3,5kg	2x

 Extrator multiválvulas
 Desmontador multiválvulas



Características:
Cromado
Montagem e desmontagem das molas das válvulas
Para motores a gasolina e diesel
Compressão e libertação rápida e fácil
Contém 2 adaptadores 25mm e 30mm

Características:
Cromado
Para motores gasolina y diesel
Comprensión y liberación rápida y fácil
Contiene 2 adaptadores de 25mm y 30mm
Montaje y desmontaje de muelles de válvulas

REF			
2104	72-225mm	2,6kg	10x

 Compressor molas multiválvulas
 Compresor muelle multiválvulas



Aplicação: Adequado para uso em motores multiválvulas gasolina e diesel com válvulas de assento profundo
Capacidade de 55-175mm e profundidade de 165mm

Aplicación: Adequado para su uso en motores multiválvulas de gasolina y diésel con válvulas de asiento profundo
Capacidad de 55-175 mm y profundidad de 165mm

REF			
2106	55-175mm	2,2kg	5x

 Ferramenta para limpeza ranhuras segmentos
 Limpiador ranura de pistón



Aplicação: Para remoção dos depósitos de carbono nas ranhuras do anel do pistão

Medidas:
Jogo completo de três cortantes de seis lâminas
Cortante 1: 1/16", 5/64", 3/32", 1/8", 5/32", 3/16"
Cortante 2: 2, 2.5, 3, 4, 4.5mm e 1/4"
Cortante 3: 1.2, 1.5, 1.8, 2.8,5,5.5mm

Aplicación: Para eliminar los depósitos de carbono en las ranuras del anillo del pistón

Medidas:
Juego completo de tres fresas con seis cuchillos
Fresa 1: 1/16", 5/64", 3/32", 1/8", 5/32", 3/16"
Fresa 2: 2, 2.5, 3, 4, 4.5mm y 1/4"
Fresa 3: 1.2.1.5,1.8.2.8.5.5.5mm

REF		
1912	380gr	50x

 Cinta de segmentos 175mm
 Ceñidor de segmentos pistón 175mm



REF	⊖	∏	⚖	📄
1285	53-175mm	80mm	260gr	50x

 Cinta de segmentos 175mm
 Ceñidor de segmentos pistón 175mm



REF	⊖	∏	⚖	📄
1290	60-175mm	150mm	525gr	40x

 Jogo 4 desconectores de tubos
 Juego 4 desconectores de tubos



 Medidas: 3/8", 1/2", 5/8", 3/4"

 Medidas: 3/8", 1/2", 5/8", 3/4"

REF	⚖	📄
5633	85gr	1x

 Pistola ponto motor
 Pistola estroboscópica digital con avance



Lâmpada / Lámpara



9620-1

 **Características:**
 Voltagem: 12V
 Potência: 10W
 Display LED com leitura digital
 Função de seleção de avanço
 Ângulo teste máximo de 90°
 Teste a velocidade de rotação e ângulo de avanço
 Precisão 0.2°

 **Características:**
 Voltaje: 12V
 Potencia: 10W
 Pantalla LED con lectura digital
 Función de selección de avance
 Ángulo de prueba máximo de 90°
 Prueba la velocidad de rotación y ángulo de avance
 Precisión 0.2°

REF	⚡	⚖	📄
9620	12V	740gr	20x

 Régua rectificada para verificar empenos
 Regla para verificar culata



 **Características:**
 Comprimento: 600mm / 23-5/8"
 Largura: 36mm
 Espessura: 16mm
 Material: aço S50C
 Tolerância: 0.05mm

 **Características:**
 Longitud: 600mm / 23-5/8"
 Ancho: 36mm
 Espesor: 16mm
 Material: acero S50C
 Tolerancia: 0.05mm

REF	↔	⚖	📄
1350	600mm	2,4kg	4x

KITS SINCRONIZAÇÃO

KIT CALADO

08



KROFtools[®]
PROFESSIONAL TOOLS

 FAMÍLIA	PÁGINAS
01 FERRAMENTA MANUAL	11-106
02 ALICATES	109-120
03 BITS E CONJUNTOS	123-134
04 FERRAMENTA ESPECÍFICA	137-214
05 FERRAMENTA CARROÇARIA	217-222
06 REGULAÇÃO E TESTE	225-246
07 FERRAMENTA MOTOR	249-276
08 KITS SINCRONIZAÇÃO	279-350
09 FERRAMENTA ELÉTRICA	353-362
10 FERRAMENTA PNEUMÁTICA	365-378
11 FERRAMENTA HIDRÁULICA	381-404
12 FERRAMENTA LUBRIFICAÇÃO	407-414
13 EQUIPAMENTO GARAGEM	417-502
RT ROUPA DE TRABALHO	505-508
MR MERCHANDISING	511-514
EP EXPOSITORES	517-524
LR LOCALIZAÇÃO REFERÊNCIAS	527-538

 FAMILIA	PÁGINAS
01 HERRAMIENTA MANUAL	11-106
02 ALICATES	109-120
03 PUNTAS Y CONJUNTOS	123-134
04 HERRAMIENTA ESPECÍFICA	137-214
05 HERRAMIENTA DE CARROCERIA	217-222
06 REGULACIÓN Y PRUEBAS	225-246
07 HERRAMIENTA PARA MOTOR	249-276
08 KIT CALADO	279-350
09 HERRAMIENTA ELÉCTRICA	353-362
10 HERRAMIENTA NEUMÁTICA	365-378
11 HERRAMIENTA HIDRÁULICA	381-404
12 HERRAMIENTA LUBRICACIÓN	407-414
13 EQUIPAMENTO PARA TALLER	417-502
RT ROPA DE TRABAJO	505-508
MR MERCHANDISING	511-514
EP EXPOSITORES	517-524
LR LOCALIZACIÓN REFERENCIAS	527-538



 Medidor tensão correia distribuição
 Medidor tension correa distribución



 **Largura máxima das correias:**

12mm

Aplicação:

Este medidor é utilizado para ajustar as correias de distribuição onde o movimento da correia é medido na unidade (Nm)

Adequado para correias com várias espessuras

Para correias com espessuras acima de 5mm consulte a tabela que consta na ficha técnica

 **Anchura máxima correas:**

12mm

Aplicación:

Este medidor se utiliza para ajustar las correas de distribución, donde el movimiento de correa se mide en la unidad (Nm)

Correas adecuados con diferentes espesores

Para correas con espesores superiores a 5mm consultar la tabla en la ficha técnica

REF			
2899	0-2	375gr	40x

 Ferramenta posição de ponto morto superior (PMS)
 Herramienta para el PMS



 **Aplicação:** Para veículos a gasolina e diesel

Utilização: Através do buraco das velas incandescentes este dispositivo consegue verificar a rotação do motor, quando o pistão alcança o ponto morto superior PMS. Através do movimento do nível do flutuação do indicador do dispositivo

Adaptadores: 8, 10, 12, 14, 18mm

Extensões de alumínio: 60mm e 160mm para acessos difíceis das velas incandescentes

Gancho magnético para o uso livre das mãos

 **Aplicación:** Para vehículos gasolina y diesel

Utilización: A través del agujero de bujías incandescentes este dispositivo puede comprobar la velocidad del motor cuando el pistón alcanza el punto muerto superior PMS. A través del nivel de movimiento de la flutuação dispositivo de visualización

Adaptadores: 8, 10, 12, 14, 18mm

Extensiones de aluminio: 60mm y 160mm para accesos difíciles de las velas encandescentes

Gancho magnético para el uso libre de sus mano

REF		
1570	300gr	1x

 Ferramenta bloqueio universal dupla árvore cames
 Herramienta bloqueo universal doble árbol levas



 **Aplicação:**

Motores padronizados em V com 4 eixos de excêntricos
Para fixar as rodas dentadas dos eixos excêntricos para trocar a correia dentada

Também é apropriado para bloquear rodas dentadas das bombas injetoras, o dispositivo é colocado nos dentes e assegura um bloqueio firme e seguro as rodas dentadas, pode ser montado paralelamente ou lateralmente deslocado

Com alavancas compactas, com grande efeito de alavanca, asseguram com uma firme fixação

 **Aplicación:**

Motores estandarizados en V con 4 ejes excéntricos
Para fijar los engranajes de los ejes excéntricos para cambiar la correa de distribución

También es adecuado para bloquear las ruedas dentadas inyector de bombas, el dispositivo se coloca en los dientes y asegura una firme y ruedas dentadas de bloqueo de seguridad, puede ser montado en paralelo o desplazado lateralmente

Con palancas compactos, con gran apalancamiento, asegurar con un agarre firme

REF		
1557	800gr	1x

Descravador e cravador de corrente
 Desbloqueo y engarce de la cadena



Medidas: 2.2, 2.9, 3.8mm

Características:

Para partir e unir a maioria das correntes de transmissão com tamanhos de corrente entre 35 e 630
 O kit inclui 3 pinos de diferentes tamanhos para se adaptar à maioria das correntes: 2.2mm, 2.9mm e 3.8mm
 Material dos pinos: Aço de liga

Medidas: 2.2, 2.9, 3.8mm

Características:

Para cortar y unir la mayoría de las cadenas de transmisión con tamaños de cadena entre 35 y 630
 El kit incluye 3 tamaños de pasadores para adaptarse a la mayoría de las cadenas: 2.2mm, 2.9mm y 3.8mm
 Material de los pasadores: Acero aleado

REF

1612



1kg



20x

Jogo descravador/cravador corrente
 Extractor remachador de cadenas



Medidas: 2.2, 2.9, 3.8mm

Características:

Para partir e unir a maioria das correntes de transmissão com tamanhos de corrente entre 25 e 530
 O kit inclui 3 pinos de diferentes tamanhos para se adaptar à maioria das correntes: 2.2mm, 2.9mm e 3.8mm
 Material dos pinos: Aço de liga

Medidas: 2.2, 2.9, 3.8mm

Características:

Para cortar y unir la mayoría de las cadenas de transmisión con tamaños de cadena entre 25 y 530
 El kit incluye 3 tamaños de pasadores para adaptarse a la mayoría de las cadenas: 2.2mm, 2.9mm y 3.8mm
 Material de los pasadores: Acero aleado

REF

1613



925gr



10x

Inclinómetro digital
 Inclinómetro digital



Características:

Gama de medição: 4 x 90°
 Resolução: 0,05°
 Precisão: -0,2° a +0,2°
 Repetibilidade: -0,1° a +0,1°
 Bateria: 2 pilhas AAA

Temperatura de funcionamento:
 -10 a 50°C
 Humidade de funcionamento:
 <85%

Características:

Rango de medición: 4 x 90°
 Resolución: 0,05°
 Precisión: -0,2° a +0,2°
 Repetibilidad: -0,1° a +0,1°
 Bateria: 2 pilas AAA

Temperatura de trabajo:
 -10 a 50°C
 Humedad de trabajo: <85%

REF

1733



920gr



50x

Chave tensor correia Fiat 1.4/1.6
 Llave tensor correa Fiat 1.4/1.6



Aplicação: Esta ferramenta permite a remoção / instalação da correia em V no veículo mesmo em espaços reduzidos
 Facilita o pré-tensionamento e o bloqueio das correias em V
Motores: Fiat, 1.4/1.6

Aplicación: Esta herramienta permite la extracción / instalación de la correa en V en el vehículo incluso en espacios reducidos
 Facilita el pretensado y bloqueo de los tensores de correas en V
Motores: Fiat, 1.4/1.6

REF

2897



725gr



20x

 Kit sincronização Fiat 2.2/2.3/3.0JTD

 Kit calado Fiat 2.2/2.3/3.0JTD

	2.2 JTD, 2.3 JTD, 3.0 JTD
	Fiat: F1AE0481C, F1CE0481D, 4HV
	Fiat

Nota: Para códigos OEM, consultar website

Nota: Para códigos OEM, consultar sitio web

REF		
1520	5kg	2x

 Kit sincronização Fiat 2.5D/2.8D

 Kit calado diesel Fiat 2.5D/2.8D

	2.5D/2.8D
	Croma (86-97), Ducato (86-06), Talento (87-94)
OEM	1860638000, 1870667000, 187076501, 1860617000

REF		
1706	140gr	96x

 Kit sincronização Fiat 1.6

 Kit calado Fiat 1.6

	1.6 12V/16V
	182 A4.000, 182 A6.000, 182 B6.000
	Brava, Bravo, Coupé. Marea, Marea Weekend, Tipo, Stilo
OEM	1 895 443 000, 1 860 874 000, 1 860 876 000 1 860 874 000

REF		
1507	1,87kg	2x

 Kit sincronização Fiat 1.3/1.9 Multijet

 Kit calado Fiat 1.3/1.9 Multijet

	1.3/1.9 Multijet
	Fiat
OEM	EN-46788, 1 860 905 000, EN-46785, 1 860 905 000, KM 6130, KM-6349, EN-46785, EN-46789, EN-46781, EN-46789-100

REF		
1510	1,9kg	5x

 Kit sincronização Fiat 1.2/1.4/1.6/1.8/2.4D/JTD 12/16/20V

 Kit calado Fiat 1.2/1.4/1.6/1.8/2.4D/JTD 12/16/20V

	1.2/1.4/1.6/1.8/2.4D/JTD 12/16/20V
	Bravo, Novo Bravo, Bravia, Palio, Marea, Tipo, Stilo, Novo 500, Panda, Punto, Grande Punto, Idea, Linea, Palio weekend
	1 895 443 000, 1 860 992 000, 1 860 932 000, 1 860 987 000, KM 6130, KM6349, 1 860 905 000, 1 860 985 000, 1 860 766 000, 1 860 161 000, 1 860 771 000, 1 860 845 000

REF

1526



6,25kg



2x

 Kit sincronização Fiat 1.9 JTD

 Kit calado Fiat 1.9 JTD

	1.9 JTD
	Punto, Grande Punto, Idea, Brava / Bravo, Novo Bravo, Marea Weekend, Stilo, Croma, Multipla, Doblo
	1.860.905.000, 1.860.905.010, 1.870.896.900, 1.860.898.000

Nota: Para códigos de motor, consultar website

Nota: Para códigos de motor, consultar sitio web

REF

1532



1,8kg



5x

 Kit sincronização Fiat 1.2

 Kit calado Fiat 1.2

	1.2 16V
	176 B9 000, 182 B2. 000, 188 A5 000
	Bravo, Brava, Punto, Stilo
	1 860 985 000, 1 860 987 000, 1 860 992 000

REF

1536



2,5kg



5x

 Chave para segurar árvore de cames Fiat 1.3 JTD

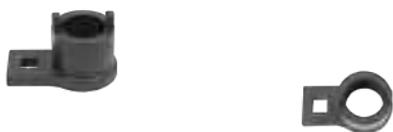
 Llave para sostener árbol de levas Fiat 1.3 JTD

	1.3 JTD
	1.871.008.600
	Fiat

REF

6447



1/2"



600gr



1x

 Kit sincronização Fiat 1.3 diesel
 Kit calado Fiat 1.3 diesel



Ferr. retenção cambota
Herr. retención cigüeñal



REF 1657F

Acessórios fixação
Accesorios fijación



REF 1657S

Chave retenção
Llave sujeción



REF 1657A

Alavanca tensão
Palanca tensor



REF 1657B

	1.3
	188A9.000, 169A1.000, 188A8.000, 199A3.000, 188A9.000, 188A9.000
	Punto (03-07), Panda (03-09), Idea (04-06), Doblo (04-06), Doblo Cargo (04-06)
	1 871 000 200, 1 871 000 900, 1 860 985 000, 1 870 900 400, 1 870 900 300

REF

1657



1,8kg



5x

 Kit sincronização Fiat 1.3 CDTI
 Kit calado Fiat 1.3 CDTI



	1.3 CDTI
	188A9.000, 169A1.000, 188A8.000, 199A3.000, 188A9.000, 188A9.000, 188A9.000
	Punto (03-07), Panda (03-09), Idea (04-06), Doblo (04-06), Doblo Cargo (04-06)
	104-A EN 46781, EN-46785

REF

1511



1,2kg



5x

 Kit sincronização Fiat, Lancia 1.2/1.4 8V
 Kit calado Fiat, Lancia 1.2/1.4 8V



	1.2/1.4 8V
	169A4.000, 188A4.000, 199A4.000, CNG 199A7.000, 350A1.000
	Fiat: 500 (07-12), Doblo/Cargo (05-10)/Gran- de Punto (07-12)/Idea (04-12), Linea (07-11), Panda EVO2 (05-11), Punto EVO (09-12) Lancia: Ypsilon (06-11), Musa (05-12)
	2 000 004 000 / 1 870 823 000, 2 000 004 300, 2 000 004 200, 2 000 004 500, 1 860 978 000, 12 000 004 400

REF

1560



2,4kg



5x

 Kit sincronização Fiat 2.3/3.0 JTD
 Kit calado Fiat 2.3/3.0 JTD



	2.3, 3.0 JTD
	F1AE0481C, F1AE0481D, F1AE0481N
	Multijet 120 2.3 JTD (02-06), Multijet 120 2.3 JTD (02-08), Multijet 160 3.0JTD (06)
	99 360 615, 1 860 617 000, 99 360 614, 2 000 018 200

REF

1562



592gr



40x

 Kit sincronização Alfa Romeo, Fiat, Lancia 0.9
 Kit calado Alfa Romeo, Fiat, Lancia 0.9



	0.9
	Alfa Romeo: 312A2.000 Fiat: 312A2.000 Lancia: 312A2.000
	Alfa Romeo: Mito (2012) Fiat: Panda 500/500C (2010), Panda (2012) Punto (2012) Lancia: Ypsilon (2011)
	2 000 035 300, 2 000 035 100, 2 000 035 200

REF

1573



1,3kg



5x

 Kit sincronização Alfa Romeo, Fiat gasol. 1.4/1.6/1.8/2.0/12/16/20v
 Kit calado Alfa Romeo, Fiat gasol. 1.4/1.6/1.8/2.0/12/16/20v



	1.4,1.6,1.8,2.0 12/16/20V
	Alfa Romeo: 145 (96-01), 146 (96-01), 147 (01-11), 155 (96-98), 156 (97-06), 166 (98-07), Spider (95-03), GTV (95-03), GT (04-10) Fiat: Barchetta (96-00), Brava (95-00), Bravo (98-00), Coupe (96-01), Marea (96-00), Marea Weekend (96-00), Punto/Punto Classic (99-06), Classic (99-06), Stilo (01-08)

! **Info:** Necesita adquirir em separado o comparador (1685)

! **Info:** Necesita adquirir em separado el comparador (1685)

REF

1504



5kg



2x

 Kit sincronização Alfa Romeo 1.75 TBI
 Kit calado Alfa Romeo 1.75 TBI



	1.75
	939B1.000, 940A1.000
	Alfa Romeo: 159, Brera (09-12), Giulietta (10-15), Spider (09-11), Lancia: Delta (09-15)
	2000 033 500, 1 860 898 000, T40011

REF

1617



2,5kg



1x

 Kit sincronização Alfa Romeo, Fiat, Lancia 1.9 JTD/TD/MultiJet/2.1/2.2/2.4

 Kit calado Alfa Romeo, Fiat, Lancia 1.9 JTD/TD/MultiJet/2.1/2.2/2.4



	1.9 JTD/TD, 1.9 MultiJet, 2.1 12v TD, 2.1D TURBO, 2.2D TD, 2.4 JTD
	Alfa Romeo: 145 (98-01), 146 (98-01), 147 (01-10), 156 (97-06), 159 (05-10), 166 (98-07) Fiat: Bravo/Brava (95-02), Bravo (07-09), Doblo / Cargo (00-10), Idea (04-08), Marea/Marea Weekend (96-03), Multipla (99-11), Palio Weekend (00-06), Punto/Punto Classic (08-10), Ritmo (01-08) Stilo (00-06), Ulysee (96-at), Scudo, Strada Pickup (00-06) Lancia: Kappa (98-02), Lybra (99-07), Musa (04-11), Thesis (02-07)
	1 860 863 000, 1 860 905 000 / 010 1 860 88 000, 1 860 965 000

Nota: Para códigos de motor, consultar website

Nota: Para códigos de motor, consultar sitio web

REF		
1561	1,4kg	5x

 Kit sincronização Alfa Romeo 1.9/2.4 JTD

 Kit calado Alfa Romeo 1.9/2.4 JTD



	Alfa Romeo: 1.9 JTD 8V, 1.9 JTD 16V, 2.4 JTD 10V, 2.4 JTD 20V Fiat: 1.9 D/TD, 2.4D
	Alfa Romeo: 145 (98-01), 146 (98-01), 147 (01-09), 156 (97-08), 159 (05-09), CrossWagon (04-08) 166 (98-08), GT (04-09), Brera (05-09), Spider (06-09) Fiat: Punto 1.9 D, Brava, Bravo 1.9 D Turbo, Marea, Weekend 1.9 D Turbo, Punto 1.9 JTD, Brava, Bravo 1.9 JTD, Marea Weekend 2.4 JTD, Multipla 1.9 JTD (post. 96), Marea 2.4 D Turbo, Marea Weekend 2.4 D Turbo
	1.860.890.000, 1.870.896.900, EN-46789, 32 025 008, 1.860.905.000

REF		
1566	1,45kg	5x

 Kit sincronização Alfa Romeo / Fiat 1.4 Multiair Gasolina

 Kit calado Alfa Romeo / Fiat 1.4 Multiair Gasolina



	1.4
	Alfa Romeo: 940A2.000, 940A2.000, 955A8.000, 955A8.000, 940A2.000, 955A8.000, 955A2.000, 955A7.000-5250, 955A6.000, 955A8.000, 955A2.000, 955A6.000, 955A8.000, 955A8.000, 955A7.000 Fiat: 955A2.000, 955A6.000, 955A8.000, 955A8.000, 955A7.000
	Alfa Romeo: Giulietta, Mito Fiat: Punto, Punto EVO
	2000034400, 2000004500, 1860987000

REF		
1684	1,5kg	5x

 Kit sincronização Alfa Romeo / Fiat 1.4/1.6/1.8 Gasolina

 Kit calado Alfa Romeo / Fiat 1.4/1.6/1.8 Gasolina

	1.4/1.6/1.8
	Alfa Romeo: 159 (05-10) Fiat: Croma (06-11), Stilo (05-08)
	2 000 012 000, 2 000 012 100, 2 000 012 800

REF		
1645	1,1kg	5x

 Jogo sincronização Fiat 1.0/1.3 Gasolina

 Kit calado Fiat 1.0/1.3 Gasolina

	1.0/1.3
	55282151, 55282328
	Fiat: 500X (2018-), Tipo (2020-)
	2063500090, 206300090, 2064000090.

REF		
1726	1,9kg	5x

 Jogo sincronização Fiat, Lancia 1.0 Híbrido

 Kit calado Fiat, Lancia 1.0 Híbrido

	1.0i
	55282151, 55282328
	Fiat: 500, 500C Lancia: Ypsilon (2018-), Tipo (2020-)
	2063500090, 206300090, 2064000090.

REF		
1727	2,5kg	10x

 Kit sincronização BMW M52/M54/M56

 Kit calado BMW M52/M54/M56

	20 25 28 6S 2 (M52), 20 25 6S 4 28 6S 2 (M52), 28 6S 2 (M52), 20 6S 4 28 6S 2 (M52), 22 6S 30 6S 3 (M54), 30 6S 3 (M54), 22 6S 1, 22 6S 1, 25 6S 5, 30 6S 3, 25 6S 5 30 6S 3
	320i 323i 328i Coupe (98-01), 520i 523i 528i (98-01), 728i (98-02), Z3 2.0i 2.8i (99-03), Z3 2.2i 3.0i (00-03), X5 3.0i (99-07), 320i (00-07), 520i (00-03), 520i (03-05), 325i Compact (00-07), 330i (00-07), 525i 530i (00-03), 525i 530i (00-03), 730i (02-05), X3 3.0 (03-07), Z4 2.5 3.0 (03-06)
	11 6 150, 11 4 220, 11 3 450, 11 3 292, 11 6 180

	M52/M54/M56
---	-------------

REF		
1527	2,6kg	2x

 Kit sincronização BMW 1.6/1.8/1.9 M43
 Kit calado BMW 1.6/1.8/1.9 M43



	1.6/1.8/1.9 M43
	316i E36 (93-99); 316i E46 (99-01); 316i Compact E36 (94-01); 318i E36 (93-99); 518i E34 (94-96); Z3 1.9i (99-03) 316/318 (98-04); Z3 1.9i, 750i E38 (94-02); 850i E31 (94-99); 750i E32 (87-94); 850i E31; 850CSi E31 (90-99)
	11 3 190, 11 2 300

REF		
1528	1,9kg	5x

 Kit sincronização BMW 320/330d M47
 Kit calado BMW 320/330d M47



	2.0D TD4 3.0D TD6, M47 / M57, M47TU / M57TU, M47T2 / M57T2
	20 4D 1, 20 4D 4, 25 6D 1, 25 6D 2, 30 6D 1, 30 6D 2, 30 6D 3, 30 6D 4, 30 6D 5
	18D (03-07), 120D (03-07), 318D/TD (00-07), 320D/CD (97-07), 325D (06-08), 330D/XD/ CD (98-08), 335D (06-08), 520D (99-08), 525D/XD (99-08), 530D/XD (98-08), 535d (04-08), 635D (04-08), 730D/LD (98-08), X3 2.0D (03-07), X3 3.0D/SD (03-08), X5 3.0D (00-08)
	11 6 320, 11 3 340, 11 6 322, 11 2 300

REF		
1501	1,7kg	5x

 Kit sincronização BMW 1.7D/2.5D
 Kit calado BMW 1.7D/2.5D



	1.7D/2.5D, TD/TDS M41/M51
	318TDS, 325TDS, 525TDS, 725TDS (94-03)
	174T1, 256T1

REF		
1534	5,75kg	2x

 Kit sincronização BMW E30/34/36/38/46/M42/50/52/60
 Kit calado BMW E30/34/36/38/46/M42/50/52/60



	M50/M52/M42
	318TDS Compact E36, 318iS E30, 318iS Coupé Compact E36, 318Ti Compact E36, 320i, 323i, 325i, 328i E36, 520i E34/E39, 523i E39, 525i E34, 528i E39, 728i E38, Z3 1.9/2.8i (89-98), 316i/ Compact E30 1.6/E36/E46, 318i E30/E36/E46), 518i E34 Vanos, Z31.8/1.9i (88-04), 316i Compact E30 1.6 E36/E46, 318i E30, E36 E46, 518i E34 Vanos, Z3 1.8/1.9i (88-04), 325TD/TDS E36, 525TD/ TDS E34/E39, 725TDS E38 (91-03)
	11-3-240, 11-2-300, 11-5-490, 11-3-190, 11-3-320, 11 3 290

Nota: Para códigos de motor, consultar website
Nota: Para códigos de motor, consultar sitio web

REF		
1530	4,06kg	2x

 Kit sincronização BMW 1.8, 2.0 N42/N46/N46T
 Kit calado BMW 1.8, 2.0 N42/N46/N46T



	1.8/2.0 N42/N46/N46T
	118i, 120i E81/E82/E87, 1.8/2.0 N46 B20B, N46T B20 (04-09), 316i, 316i Compact E46, 1.6 N42 B18A, N46 B18 (01-05), 318i, 318TI Compact (E46) 1.8 N42 B20A, N46, B18 N46 B20 (01-06), 318i, 320i (E90, E91, E92, E93) 1.8 2.0 N42 B18A N46 B20B (05-08), Z4 (E85,E86) 2.0 N46 B20 (04-09), X3 E83 2.0 N46 B20B (05-09)
	11 9 350, 11 5 120 11 2 300, 11 9 290 291 11 9 190, 11 9 290/293, 11 9 290/292, 11 9 340

REF

1537



2,7kg



5x

 Kit sincronização BMW E38/46/53/60/61 98-08
 Kit calado BMW E38/46/53/60/61 98-08



	E38/46/53/60/61 (98-08)
	BMW 320D (E46), 330D (E46), 530D, 730D (E38), 2.5D (M51), M47, M47T2, M47TU, M57, M57TU, 318td/320d (E46) 88-05; 318td, 320td, 525D, 530D, 530, 535 (E60/61) (00-06) 730D (E38), X5 3.0D (E53)
	11 6 320, 11 6 322, 13 5 120, 11 2 300, 11 3 340 13 5 191, 13 5 192, 13 5 190, 11 5 180, 11 6 080

REF

1538



5,1kg



2x

 Suporte de trabalho para motores BMW N42/N46/N46t
 Soporte de trabajo para motores BMW N42/N46/N46t



	1.8, 2.0, N42, N46, N46t, (B18b, B18, B20 B20a B20b) 118i, E87, 120i, E87, 316i, E46, 316ti, E46, 318i, E46, 318ti, E46 318i, E90, 320i, E90, 520i, E60, Z4, 2.0 E85, X3.2i, E83
	BMW
	11 9 310, 11 9 301, 11 9 320, 11 9 302 11 9 303 11 9 390

REF

1543



5,75kg



2x

 Kit sincronização BMW 1.6 gasolina N40/N45/N45T
 Kit calado BMW 1.6 gasolina N40/N45/N45T



	1.6 N40/N45/N45T
	N40 B16A / N45 B16A / B16AC, N45 B16A / B16AC, N45T B16
	BMW
	1 7 260, 1 7 251, 11 9 340 / 11 9 341, 1 7 252, 1 9 190

REF

1539



2,4kg



5x

 Kit sincronização BMW N62/N73
 Kit calado BMW N62/N73



	3.6,4.0,4.4,4.8 V8 N62/N62TU, 6.0 V12 N73
	540i E60/61 (05-10), 545i E60/61 (03-06), 550i E60/61 (05-10), 645i E63/64 (03-06), 650i E63/64 (05-11), 735i E65/66 (02-05), 740i E65/66 (05-08), 745i E65/66 (02-05), 750i E65/66 (05-08), 760i E65/66 (02-08), X5 4.4 E53 (03-07), X5 4.8 E53/E70 (04-10).
	11 9 462, 11 9 463, 11 9 461, 11 9 190, 11 9 340

REF		
1548	2,7kg	5x

 Kit sincronização BMW, Mini N47/N47S 2.0D 1.6/2.0
 Kit calado BMW, Mini N47/N47S 2.0D 1.6/2.0



	BMW: 2.0 N47/N47S (07-10) BMW Mini: 1.6, 2.0		BMW: Série 1: 116d,118d,120d,123d (E81,E82,E88,F20) Série 3: 316d,318d,320d,325d,330d (E90,E91,E92,E93,F30) Série 5: 520d,525d,530d,535d,550d (E60,E61,F07,F10,F11) Série 7: 730d,740d, 750d (F01) X1: 1.8d,2.0d,2.3d (E84) X3: 1.8d,2.0d,3.0d,3.5d (E83,F25) X5: 3.0d,4.0d,5.0d (E70) XDRIVE, N57D30TO DRIVE40D, N57D3000 DRIVE30D BMW mini: (R56/57) 1.6, 2.0, Clubman (R55) 1.6, 2.0, Countryman (R60) 1.6, 2.0, Coupe (R58) 2.0, Paceman (R61) 1.6, 2.0, Clubman (R55) 1.6, 2.0
	N47/N47S - D20A, D20B, D20U0, D20O0, D20T0. N57 - D30U0, D30O0, D30O1, D30T0, N57D30A 730d, N57D30TO 740D XDRIVE, N57D30TO DRIVE40D, N57D3000 DRIVE30D		
	11 4 320, 11 3 340, 11 6 480, 11 8 760, 11 5 320, 11 8 740		

REF		
1550	3,45kg	2x

 Kit sincronização BMW alinh. escape árvore cames N42/N46
 Kit calado BMW alineación escape árbol de levas N42/N46



	BMW (N42/N46)
---	---------------

 **Descrição:** Unidade de ajuste da árvore de cames

 **Descripción:** Unidad de ajuste del árbol de levas

REF		
1565	600gr	10x

 Kit sincronização BMW M40/M43/M44/M52
 Kit calado BMW M40/M43/M44/M52



	M40/M43/43/44/52
	316i/318i M40/M43, 318i S16v S30, 318i S-Coupe 318Ti, Compact E36 M44, 320i 24v E36 M52, 323i Compact E36, 325i 24v E53, 328i E36 M52, 518i E36/64 M40/M43, 520i 24v, E34/E39, 523i E70 M52, 525i 24v E34/E39, 528i E39 M52, 728i E38 M52, Z3 1.9i/2.8i M44/M52
	11 2 300, 11 2 240

REF		
1572	1,5kg	20x

 Kit sincronização BMW N43

 Kit calado BMW N43

	Gasolina N43 corrente/cadena 1.6, 2.0 (2006-2011), N43 (B16A/AA), N43 (B20A), N43 (B20AA), N43 (B20AY), N43 (B20KO), N43 (B20UO)
	Serie 1 E81 / E82 / E87 / E88, 2006-2012 Serie 3 E90 / E91 / E92 / E93, 2006-2012 Serie 5 E60 / E61, 2007-2010
	B126A/AA, B16AA, B20KO, B20AY, B20A, B16AA/OO B20AY, B20UO, B20A, B20A/AA

REF

1569



5,25kg



2x

 Kit sincronização BMW S54

 Kit calado BMW S54

	S54
	M3 E46, S54 (32-6S-4) 3.2 (2000-), Z3 (M) E36, S54 (32-6S-4) 3.2 (2000-), Z4 (M) E85/E86, S54 (32-6S-4) 3.2, (2006), M3 (CSL) E46, S54 (32-6S-4) 3.2 (2003)
	11 9 140, 11 7 160, 11 7 342, 11 9 130 11 2 300, 11 9 170

REF

1606



1,3kg



2x

 Kit alinhamento bomba óleo e eixo BMW 1.6/2.0 gasolina

 Kit alineamiento bomba aceite y eje BMW 1.6/2.0 gasolina

	1.6L / 2.0L
	N20, N26
	Serie 1 (2012-2016), Serie 2 (2014-2016), Serie 3 (2012-2016), Serie 4 (2014-2016), X1 (2011-2015), X3 (2011-2017), X4 (2014-2017), Z4 (2011-2017)
	2 212 825, 2 318 117, 11 4 120

REF

1636



500gr



10x

 Kit sincron. eixo balanceador motor diesel BMW N47/N47S

 Kit calado eje balanceador motor diesel BMW N47/N47S

	1.6/2.0D N47, N47S
	118d (E81/E82/E87/E88/F20/F21), 120d (E81/E82/E87/E88/F20/F21), 123d (E81/E82/E87/E88), 125d(F20/F21), 318d (E90/ E91/F30/F31/F34), 320d (E90/E91/E92/E93/F30/F31/F34) 520d (E60/E61/F07/F10/F11), X3, 1.8d, 2.0d (E83)
	11 8 750, 11 8 790, 11 8 791

REF

1618



2,5kg



4x

Ferramenta instalação / remoção apoio volante motor BMW B38
Herramienta instalación / remoción apoyo volante motor BMW B38



	B38
	BMW
OEM	0496595 (116130)

REF		
1642	430gr	10x

Ferramenta eixo equilíbrio BMW B46/B48
Herramienta ejes equilibrado BMW B46/B48



	B46/B48
	BMW
OEM	2361286

Nota: As engrenagens são pressionadas no eixo de contrapeso com um cone e pode desanexar apenas com a ferramenta especial 1643. Aparafusar o parafuso (2) da ferramenta especial 1643 e retirar o eixo de contrapeso da engrenagem.

Nota: Las engranajes se presionan sobre el eje de contrapeso con cono y lata solo se separa con la herramienta especial 1643. Atornille el perno (2) de la herramienta especial 1643 para separar el eje de contrapeso del engranaje.

REF		
1643	270gr	50x

Ferramenta alinhamento carretos árvore cames BMW N47D20/B47/B48
Herramienta de alineación árbol levas BMW N47D20/B47/B48



	BMW: BMW 1.5 Diesel Series 1 2015 <, series 2 2014 <, X1 2015 <, BMW Mini One 2014
	LKU / B13DTE, LKU / B13DTR, LKV / B13DTC
	Serie 1 (2012-2016), Serie 2 (2014-2016), Serie 3 (2012-2016), Serie 4 (2014-2016), X1 (2011-2015), X3 (2011-2017), X4 (2014-2017), Z4 (2011-2017)
OEM	11 5 370

REF		
1653	440gr	50x

Ferramenta alinhamento eixos equilíbrio BMW N47D20/B47/B48
Herramienta de alineación de ejes equilibrado BMW N47D20/ B47/B48



	N47D20 / B47 / B48
	BMW
OEM	83 30 2 288054

REF		
1644	2,55kg	5x

-  Kit sincronização BMW B38/B46/B48
 Kit calado BMW B38/B46/B48



	B38, B46, B48
	BMW
	2358122, 2288380, 116480, 119340, 2360895, 2365488, 118580

REF



1659

7,3kg

5x

-  Kit sincronização BMW, Mini N13/N18
 Kit calado BMW, Mini N13/N18



	N13, N18
	N13 B16A, N18 B16/M0, N18 B16A/M0
	BMW: N13, N18 Mini: Cooper S [R56/57] (10-15), Coupe Cooper S [R58] (12-15), Countryman [R60] (12-14), Paceman [R61] (13-15)
	11 7 440, 11 9 340, 496 709, 11 9 590

REF



1660

2,5kg

5x

-  Kit sincronização BMW, Mini 1.5/2.0 diesel B37/B47
 Kit calado BMW, Mini 1.5/2.0 diesel B37/B47



	1.5/2.0
	1.5: B37 D15A; B37 C15A 2.0: B47 D20A; B47 D20B; B47 C20A; B47, B47 C20B
	BMW: Série 1 - 114d, 116d, 214d - (F20/21) - (2015-2017), Série 2 - 216d, 118d, 125d - (F22/23/45/46) - (2014-2017), Série 3 - 218d, 220d, 225d - (F30/ 31/34) - (2015-2017), Série 4 - 316d/320d/325d - (F32/33/36) - (2015- 2017), Série 5 - 420d, 425d, 418d - (F10/11) - (2014-2017), Série X1 - 518d - (F48) - (2015-2017), Série X3 - (F25) - (2014-2017) - Efficient Dynamics, Série X4 - (F26) - (2014- 2017) - xDrive, Série X5- (F15) - (2015-2017) Mini: Clubman - (F54) - (2015-2017), One D Convertível - (F57) - (2016-2017), Cooper D/ SD Mini Hatch (F55, 56) - (2014-2017)
	11 7 440, 11 9 340, 496 709, 11 9 590

REF



1668

1,7kg

5x

 Kit rodar/segurar cambota BMW B37/B38/B47/B48
 Kit rotar/sostener cigueñal BMW B37/B38/B47/B48



	B37, B38, B47, B48 1.2, 1.5, 2.0 gasolina, diesel
	BMW: Serie 1,2,3,5 (14-17), 4,7 (15-17), X1, X3, X4 (14-17), X5 (15-17) Mini: Clubman (14-17), Hatch (15-17), Conversível (16-17)
	11 6480, 11 9 811, 11 9 265, 11 4 180

REF		
1666	850gr	10x

 Kit alinhamento árvore de cames BMW S63/N63
 Kit alineación árbol levas BMW S63/N63



	BMW S63 motor 5' F10 M5 (10-14) BMW S63 motor 6' F06/F12/F13 M6 (11-14) BMW N63 motor 6' F06 650i/650ix (11-14) BMW N63 motor 7' F02 ALPINA B7LX (13-14) BMW N63 motor X' F15 X5 U (12-14)
	BMW
	2249117, 2249162, 118570, 119190, 2249140 2249144, 2249159

REF		
1670	7kg	2x

 Chave bloqueio cambota BMW M52TU/M54/M56
 Llave bloqueo cigueñal BMW M52TU/M54/M56



	M52/M54/M56
	BMW

 **Aplicação:** Para segurar a polia da cambota, enquanto desaperta ou aperta o parafuso da polia e para extrair esta
Permite remoção / instalação segura e sem danos
Para ser usado com um roquete 1/2", corrediço, etc

 **Aplicación:** Para sujetar la polea del cigüeñal, mientras afloja o aprieta el perno de la polea y para extraerla
Permite una extracción / instalación segura y sin daños
Para usar con una carraca 1/2", corredizo, etc

REF		
1675	3,5kg	4x

 Ferramenta bloqueia cambota BMW N47
 Herramienta bloqueo cigueñal BMW N47

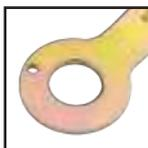

	N47
	1.6 N47 C16U1, C16K1, C16A/U1, D16C, D16, 2.0 N47 C20K1, C20U1, C20A/K1, D20B/D/T0, D20C/K1, D20C, D20C/U1, D20C/O1, D20D, D20D/T1, D20O1, D20C/O, D20A, D20C/O1, D20U0
	BMW
	2 285 671

REF		
1679	457gr	40x

 Kit remoção/alinhamento eixo equilíbrio BMW B37/B38
 Kit remoción/alineación eje de equilibrado BMW B37/B38



	B37 diesel, B38 gasolina
	1.2 Gasolina - B38 A12A, 1.5 Diesel - B37 D15A, B37 C15A, 1.5 Gasolina - B38 B15A, B38 A15A, B38 K15A
	BMW: Serie 1, 3 (15-17), Série 2 (14-17), X1 (15-17), i8 (15-17) Mini: Clubman (15-17), Mini Conversível (16-17), Mini Clubman (15-17)
	2 288 942, 2 358 646, 2 288 943

REF

1677



2,2kg



5x

 Kit sincronização BMW S65 M3
 Kit calado BMW S65 M3



	S65 M3
	S65 B40A (4.0L)
	BMW: M3 E90 / E92 / E93 (2007-2013)
	11 9 970, (11 9 971 + 11 9 972) 11 5 320, 11 5 290 (11 5 291 + 11 5 292), 11 5 370

REF

1692



3,5kg



5x

 Indicador desaste corrente distribuição árvore cames BMW, Mini 1.6D/2.0D/3.0D/1.6G
 Indicador desaste cadena transmision arbol levas BMW, Mini 1.6D/2.0D/3.0D/1.6G



	1.6D/2.0D/3.0D/1.6G		<p>BMW: Serie 1 116d,118d,120d,123d (E81/82/87/88) (07-14),114d,116d, 118d,-120d,125d/114i, 116i, 118i, 120i (F20/21) (11-16), Serie 2 218d,220d,225d (F22) (14-16), Serie 3 316d,318d,320d,325d,330d (E90/91/92/93) (07-14), 316d,318d,320d,-325d,330d,335d/316i,320i (F30/31/34) (12-19), Serie 4 420d,425d,430d,435d (F32/33/36) (14-), Serie 5 520d (E60/61) (07-10), 518d,-520d,525d,530d,535d,M550d (F10/11/07) (09-17), Serie 6 640d (F12/13/06) (11-18), Serie 7 730d,740d,750d (F01/02/04) (08-15), X1 16d,18d,20d,23d,25d (E84) (09-15), X2 18d, 20d (E83) (09-15), X3 18d,20d,30d,35d (F25) (11-17), X4 18d,20d,30d,35d (F26) (14-18) X5 30d,40d, M50d (E70) (14-18), 25d, 30d, 40d, M50d (F15) (13-18), X6 30d, 40d, M50d (F71) (10-14), 30d, 40d, M50d (F16)(14-19) Mini: One D, Cooper D, SD / One, Cooper, Cooper S, JCW, (R56/R57) (06-15) Clubman/ Clubvan: One D, Cooper D, SD / One, Cooper, Cooper S, JCW (R55) (07-14), Coupe: Cooper SD / Cooper, Cooper S, JCW (R58) (11-15), Roadster: Cooper SD / Cooper, Cooper S, JCW (R59) (12-15), Countryman: One D, Cooper D, SD / One, Cooper, Cooper S, JCW (R60) (10-17), Paceman: Cooper D, SD / Cooper, Cooper S, JCW (R61) (13-17)</p>
	<p>BMW: 1.6 diesel - N47 D16A 2.0 diesel - N47 D20A N47 D20B N47 D20C N47 D20D 3.0 diesel - N57 D30A N57 D30B N57 D30C 1.6 gasolina - N13 B16A</p> <p>Mini: 1.6 diesel - N47 C16A 2.0 diesel - N47 C20A 1.4 gasolina - N12 B14A 1.6 gasolina - N12 B16A N14 B16A N14 B16C N16 B16A N18 B16A N18 B16C</p>		

REF

1662



225gr



50x

 Kit sincronização BMW N51/N52/N53/N54/N55
 Kit calado BMW N51/N52/N53/N54/N55



	N51/N52/N53/N54/N55
	BMW: E60: 23i,523Li,525i,525Li,525xi,528i,528xi,530i,530Li,530xi,535i,535xi E61/E63: 523i,525i,525xi,530i,530xi,535xi,630i E64/E65: 630i,730i E66/E70: 730Li,X5 3.0Si E81/E82: 130i,135is E93: 325i,328i,330i,335i E83: X3 2.5i,2.5Si,3.0i,3.0Si E85/E86: Z4 2.5i,2.5Si,3.0i,3.0Si,Z4 3.0Si E87/E90: 130i,323i,325i,325xi,328i,328xi,330,330xi,335i,335xi E91: 323i,325i,325xi,328i,328xi,330i,330xi,335i,335xi E92: 323i,325i,325xi,328i,328xi,330i,330xi,335i
	110 300, 114 280, 119 340, 114 290, 118 520

REF		
1696	9kg	2x

 Kit sincronização BMW Mini 1.4/1.6/N12
 Kit calado BMW Mini 1.4/1.6/N12



	1.4/1.6/N12
	N12B14AB, N12B14AB
	Mini: One (07-10), Mini Cooper (06-10)
	11 9 540, 11 9 540, 11 9 590

REF		
1665	1,75kg	10x

 Kit sincronização BMW Mini R55/56/57
 Kit calado BMW Mini R55/56/57



	R55/56/57
	W16D16(9HZ), W16D16UO
	Mini: Clubman 1.6D R55/56/57 (07-10)
	0194A, 0194B

REF		
1601	1,3kg	1x

 Chave Especial P/ Árvore Cames VANOS 1/2" x22mm BMW
 Llave Especial P/ Árbol Levas VANOS 1/2" X22mm BMW



 **Características:** Para instalar e remover o ajustador VANOS
Aplicável: Motor BMW B38, B48, B58
Número BM: 2450487
Tamanho: 1/2" Dr. x 22mm / 16pt
Tipo de Aço: Cr-Mo

 **Características:** Para instalar y quitar el ajustador VANOS
Aplicable: Motor BMW B38, B48, B58
Número BM: 2450487
Tamaño: 1/2" Dr. x 22mm / 16pt
Tipo de acero: Cr-Mo

REF		
3323	83,2gr	200x

 Kit sincronização BMW Mini N12

 Kit calado BMW Mini N12

	N12
	1.4 N12 VTi (Valvetronic), N14. 1.6
	BMW Mini: One, BMW mini one RS6, Cooper R55/56, Cooper HB, Cooper S R55/56
	11 5 540, 11 5 590, 11 9 340, 11 9 550

REF

1553



4kg



2x

 Kit sincronização BMW-Mini 1.2/1.5/2.0/3.0 Gasolina

 Kit calado BMW Mini 1.2/1.5/2.0/3.0 Gasolina

	BMW: B58 3.0 Mini: B38 1.2/1.5, B48 2.0
	1.5 - B38 A15A, B38 B15A, B38 K15A 1.6 - B48 B16A 2.0 - B48 A20A, B48 A20B, B48 A20E, B48 B20A, B48 B20B 3.0 - B58 B30A, B58 B30B, B58 B30C
	BMW: Serie 1 (15 - 19), Serie 2 (14 -), Serie 3 (15 -), Serie 4 (15 -), Serie 5 (17 -), Serie 6 (17 -), Serie 7 (15 -), i8 (14 -), X1 (15 -), X2 (18 -), X3 (17 -), X4 (18 -), Z4 (19 -) Mini: Clubman (15 -), Hatch (14 -), Convertible (16 -), Countryman (17 -)
	2 358 122, 2 357 904, 2 365 488, 2 288 380, 11 4 120

REF

1704



5,2kg



2x

 Jogo bloqueio volante motor BMW/Mini

 Kit bloqueio volante motor BMW/Mini

	N40, N42, N43, N45(T), N46(T), N51, N52, N53, N54, N62, N73, M47TU, M54, M57T2(-TU), S85, W17
	BMW Mini
	11 9 260, 11 9 261, 11 9 262, 11 9 263, 11 9 264, 11 9 265, 11 9 266

REF

1709



290gr



50x

 Ferramenta de alinhamento tampa cambota frontal BMW/Mini

 Herramienta de alineación de la tapa delantera del cigüeñal BMW/Mini

Nota: A superfície da ferramenta deve ser mantida limpa e sem riscos para garantir um funcionamento correto

Nota: La superficie de la herramienta debe mantenerse limpia y sin arañazos para garantizar un funcionamiento correcto

	N12
	B37C, B37D, B38A, B38B
	BMW: Serie 1, Serie 2, Serie 3, Serie 4, X1, X2; MINI: Clubman, Countryman, Hatch
	2 357 900

REF

1713



375gr



20x

- Chave tensor correia Peugeot/Citroën 1.4/1.6
- Llave tensor correia Peugeot/Citroën 1.4/1.6



- Aplicação:** Esta ferramenta permite a remoção / instalação da correia em V no veículo mesmo em espaços reduzidos. Facilita o pré-tensionamento e o bloqueio das correias em V. **Motores:** Peugeot e Citroën 1.4/1.6
- Aplicación:** Esta herramienta permite la extracción / instalación de la correia en V en el vehículo incluso en espacios reducidos. Facilita el pretensado y bloqueo de los tensores de correias en V. **Motores:** Peugeot y Citroën 1.4/1.6

REF	725gr	20x
2897		

- Kit sincronização Peugeot/Citroën 2.7 / 3.0 Td V6
- Kit calado Peugeot/Citroën 2.7/3.0 TD V6



	2.7/3.0 TD V6
	DT17 / DT17BTED4, UHZ, D20CTED4, X8Z
	Peugeot: 407 (04-09), 407 Coupe (06-09), 607 (04-11) Citroën: C5 III (07-09), C6 (05-09)
	303-1117, 303-1116, 303-1132, 303-1126, 0195-H, 0195-C, 0195-K, 0188-K

REF	1,6kg	5x
1658		

- Kit sincronização PSA 1.4/1.6
- Kit calado PSA 1.4/1.6



	1.4/1.6
	Peugeot: EP3 (8FS), EP6 (5FW) Citroën: 8FR (EP3), 5FS (EP6)
	Peugeot: 207 308 (07-10) Citroën: C3 DS3 C4 VTI (08-10). Picasso DS3 C4 VTI, Octavia II (10 - 13)
	0197-A3, 0197-A1, 0197-B

REF	1,75kg	10x
1665		

- Kit sincronização 1.0/1.2 GDI Puretech PSA
- Kit calado 1.0/1.2 GDI Puretech PSA



Medidor controlo correia sincronismo
Medidor controlo correia sincronismo



REF 1707-01

	1.0/1.2
	Peugeot: 108 (14-18), 208 (12-21), 2008 (13-21), 301 (12-20), 308 (13-21), 3008 (16-21), 508 (19-21), 5008 (14-21), Partner III (15-18), Partner IV (18-21) Rifter (19-21) Citroën: Berlingo IV (18-20), C1 II (14-18), C3 II (12-17), C3 IV (16-18), C4 Cactus (14-20), C4 Aircross (18-20), C-Elysee (12-18), DS3 (12-18)
	0109-6, 0109-2B, 0109-2C, 0109-2D, 0197-N

Nota: Para códigos de motor, consultar website
Nota: Para códigos de motor, consultar sitio web

REF	740gr	5x
1707		

 Jogo bloqueio e alinhamento árvore cames 1.2 VTI PSA
 Herramienta de bloqueo y alineación del árbol de levas 1.2 VTI



	1.2 VTI
---	---------

Nota: Para códigos de motor, consultar website

Nota: Para códigos de motor, consultar sitio web

	Peugeot: 108 (14-18), 208 (12-21), 2008 (13-21), 301 (13-21), 308 (13-21), 3008 (16-21), 508 (19-21), 5008 (14-21), Partner III (15-18), Parten IV (18-21), RIFTER (19-21) Citroën: Berlingo IV (18-20), C1 II (14-18), C3 III (12-17), C3 IV (16-18), C4 Cactus (14-20), C4 Aircross (18-20), C-elysee (12-18), DS3 (12-18)
	01092B, 0109-2C, 0109-2D, 0109-6, 0197-N EN-52127-2

REF		
1719	370gr	7x

 Jogo ajuste e bloqueio distribuição PSA 1.4/1.5
 Juego ajuste PSA 1.4/1.5



	1.4 (DV4), 1.6 (DV6)
	Peugeot: 107 (05-10), 1007 (05-10), 206 (01-12), 206+ (10-13), 206CC (05-07), 207 (06-13), 207CC (07-15), 208 (12-18), 2008 (12-17), 307 (01-08), 308 (07-18), 308CC (09-17), 3008 (09-18), 407 (04-11), 4008 (12-15), 508 (11-18), 5008 (09-18), Bipper (08-10), Expert (10-12), Partner I/II (05-11), Partner III (08-18), Rifter (18-19), Traveller (16-20)

	Citroën: Berlingo I/II (05-11), Berlingo III (08-18), Berlingo IV (14-19), C1 (05-10), C2 (03-10), C3 I/II (02-10), C3 III (10-18), C III IV (16-18), C3 Picasso (09-12), C3 Pluriel (04-10), DS3 (09-12), C4 (04-11), C4 II (11-18), C4 Picasso/Grand Picasso (06-18), C5 II (04-08), C5 III (07-12), DS4 (11-12), Nemo (08-10), Xsara II (04-08), Xsara Picasso (04-10)
	0194-C, 0194-B, 0194-A

Nota: Para códigos de motor, consultar website

Nota: Para códigos de motor, consultar sitio web

REF		
1523	650gr	10x

 Kit sincronização grupo PSA HDI/HPI
 Kit calado grupo PSA HDI/HPI



	HDI (diesel), HPI (gasolina)
	Peugeot: 106, 205, 206, 306, 307, 309, 405, 406, 407, 605, 806, 807, Boxer, Expert, Partner Citroën: AX, BX, ZX, XM, Saxo, Xsara, Xantia, Synergie/Evasion, Berlingo, Dispatch/Jumpy, C15, C9

Nota: Para códigos OEM, consultar website

Nota: Para códigos OEM, consultar sitio web

REF		
1505	4,4kg	2x

 Kit sincronização PSA 1.3 CDTI
 Kit calado PSA 1.3 CDTI



	1.3 CDTI
	F13DTE5 (FHZ), FHZ(F13DTE5)
	Peugeot: Bipper (10-15) Citroën: Neno (10-15)
	104-A EN 46781, EN-46785

REF		
1511	1,2kg	5x

-  Kit sincronização completo PSA HDI/HPI
 Kit calado completo PSA HDI/HPI



Nota: Para códigos OEM, consultar website
Nota: Para códigos OEM, consultar sitio web

	HPI (gasolina): 1.1, 1.4, 1.6, 1.8, 1.9, 2.0 e 1.6, 1.8, 2.0, 2.2 16V HDI (diesel): 1.4, 1.5, 1.7, 1.8, 1.9 - 2.1, 2.5 D / TD / TDI 1.4, 1.6, 2.0, 2.2 HDI
	Peugeot: 106, 205, 306, 405, 406, 605, 806, J5, Boxer, Expert, Partner, Solara, Talbot Expres, Talbot Horizon, etc Citroën: AX, Berlingo, BX, C5, C15, C25, Dispatch, Evasion, Jumper, Jumpy, Relay, Saxo, Synergie, Visa, Xsara, Xantia, XM, XJR, ZX, etc

REF		
1516	5,1kg	2x

-  Jogo sincronização PSA 1.4/1.6
 Kit calado PSA 1.4/1.6



	Peugeot: 1.4/1.6 16V Citroën: 1.4/1.6
	EP3(8FS), EP3C(8FR), EP3 (8FS) Valvetronic, EP6(5FW), EP6C(5FS), EP6CDT(5FV), EP6DT(5FX), EP6DTS95FY), 1.6THP (DI), EP6DT (5FX), EP6DTS (5FY)
	Peugeot: 207 (06-10), 207CC (07-10), 308 (01-10), 3008 (09-12), 5008 (09-12) Citroën: C4 (08-09), C4 Picasso (08-09)
	Peugeot: 111 5 540, 11 5 590, 11 9 340, 11 9 550 Citroën: 0197-A1, 0197-A3, 0197-B

REF		
1553	4kg	2x

-  Ferramenta bloqueio polia cambota 1.0/1.2 Gasolina PSA
 Herramienta bloqueo polea cigüeñal 1.0/1.2 Gasolina PSA



	EBO 1.0 e EB2 1.2 3 cilindros de correa molhada EBO 1.0 y EB2 1.2 de 3 cilindros con correa húmeda
	Peugeot, Citroën, DS

REF		
1701	784gr	20x

-  Kit sincronização PSA 2.2/2.3/3.0JTD
 Kit calado PSA 2.2/2.3/3.0JTD



	2.2 JTD/2.3 JTD/3.0 JTD
	Citroën/Peugeot: 4HV - 100PS, 4HU - 120PS
	Citroën

Nota: Para códigos OEM, consultar website
Nota: Para códigos OEM, consultar sitio web

REF		
1520	5kg	2x

 Kit sincronização Citroën/Peugeot 1.0/1.2 VTi

 Kit calado Citroën/Peugeot 1.0/1.2 VTi

	1.0/1.2 VTi
	1PP (HM01), B12XHT, D12XHL, D12XHT, F12XHT, EB2, EB2ADT, EB2ADTD, EB2ADTS, EB2D, EB2DT, EB2DTM, EB2DTS, EB2DTS, EB2DTS, EB2DTS, EB2F, EB2FA, EB2FAD, EB2FB, EB2FD, EB2M, HMP, HMR, HMT, HMU, HMV, HMW, HMX, HMY, HMZ, HNP, HNS, HNV, HNW, HNX, HNY, HNZ, LEG, LES, LEZ

	Citroën: Berlingo III (2014-2018), Berlingo IV (2018-), C1 II (2014-2018), C3 III (2012-2017), C3 IV (2016-), C3 Picasso (2014-2017), C3 Aircross (2017-), C4 II (2014-2018), C4 Cactus (2014-2018), C4 Cactus (2017-2021), C-Elysee (2012-), C4 Picasso, Grand Picasso II (2015-2018), C4 SpaceTourer, Grand SpaceTourer (2018-), C5 Aircross (2019-), DS3/DS3 Cabrio (2013-2015), DS4 (2014-2015) DS: 3 (2015-2016), 3 II (2016-2020), 3 Crossback (2019-), 4 (2015-2015), 4 II (2015-2019), 4 Crossback (2015-2019), 7 Crossback (2018-) Peugeot: 108 (2014-2018), 208 (2012-2019), 208 II (2019-), 301 (2012-2020), 308 (2013-), 508 (2019-), 2008 (2013-2020), 2008 II (2020-), 3008 (2014-2016), 3008 II (2016-), 5008 (2014-2017), Partner III (2014-2018), Partner IV (2018-), Rifter (2018-)
	OEM 0109-2B, EN-52588 0109-2A, EN-52127-1, EN-52127-2

REF		
1646	860gr	5x

 Kit sincronização PSA 2.5D/2.8D

 Kit calado diesel PSA 2.5D/2.8D

	2.5D/2.8D
	Peugeot: Boxer (00-02), Boxer II (02-06) Citroën: Relay/Jumper (01-02), Relay/Jumper II (02-06)
	Peugeot: OEM5 0132AB 5711TD 4527TS2 0178D 0194A 119790 Citroën: OEM6 0132AB 5711TD 4527TS2 0178D 0194A 119790

REF		
1706	140gr	96x

 Ferramenta eixo equilíbrio PSA 1.0/1.2

 Herramienta fijacion ejes de equilibrio PSA 1.0/1.2

	1.0/1.2
	EB2
	Peugeot, Citroën

REF		
1729	150gr	4x

 Kit bloqueio eixo PSA

 Kit bloqueo eje PSA

	DOHC 2.2
	Peugeot: 4007, 407, 607, 807, 406, 406 Coupe, 508, 607 (2000-2015) Citroën: C5, C5 II, C5 III, C6, C8, C-Crosse 2000-2015 (2000-2015)
	OEM 303-1328 0190D, 303-1329, 303-1330

Nota: Para códigos de motor, consultar website
Nota: Para códigos de motor, consultar sitio web

REF		
1637	675gr	20x

 Kit sincronização Ford 2.0/2.2/2.4
 Kit calado Ford 2.0/2.2/2.4



	2.0/2.2/2.4
	FMBA, FMBB, D5BA, D6BA, ABFA, D3FA, D2FA, D4FA, F4FA, F6JA
	Fiesta, Fusion, Mondeo, Transit
	303-1151, 303-732/21-260, 303-679A/21-238A, 303-735/21-263, 303-734/21-262

REF		
1512	2,1kg	5x

 Kit sincronização Ford diesel 1.6/1.8/2.5
 Kit calado Ford diesel 1.6/1.8/2.5



	1.6/1.8/2.5
	4EB, E4C, 4ED, 4FB, 4FC, 4FD, 4GA, 4GB, 4GD, 4GE, 4HB, 4HC
	Courier/ Kombi 1.8, Escort Van 1.8D/TD, Fiesta 1.8DT, Fiesta Van 1.8D, Flareside 2.5D, Focus 1.8D Turbo, Galaxy 1.9Td, Mondeo 1.8TD, Orion 1.8D/TD, P100 1.8 TD, Sierra 1.8 TD, Transit 2.5 DI/Turbo TCI
	0153-M 0178/C/D, 21-104, 21-105, U40021 / MP1-300, 2065A, 0178B, 0178A, 23-020, 23-019, 21-123 KM6011

REF		
1521	950gr	10x

 Kit sincronização Ford 1.5 EcoBoost gasolina
 Kit calado Ford 1.5 EcoBoost gasolina



	1.5
	YZJA, Y2DA, Y1DA, YZDA
	Ford Focus EcoBoost (18-), Ford Focus ST EcoBoost (18-), Fiesta Duratec (18-), Ford Kuga 1.5L EcoBoost (I3) (19-)
	303-1643, 303-1649, 303-1645

REF		
1718	2,5kg	5x

 Kit sincronização Ford 1.8-TDDI/TDCI

 Kit calado Ford 1.8-TDDI/TDCI

	1.8 TDDI/TDCI
	1.8D TDCi: BHPA, F9DA, F9DB, FFBA, FFDA, FFWA, HCPA, HCPB, KHBA, KKDA, KKDB, P7PA, P9PA, P9PB, QYBA, QYWA, R2PA, R3PA, RWPA, RWPC 1.8D TDCi ECONetic: KHBA 1.8D Tdi: BHDA, BHDB, BHPA, C9DA, C9DB, C9DC 1.8D Turbo: C9DC, RTN, RTP, RTQ
	C-MAX (07-10), Courier (00-02), Fiesta (00-02), Focus (98-11), Focus C-MAX (03-07), Galaxy (06-10), Mondeo (07-10), S-MAX, (06-10), Tourneo Connect (02-12), Transit Connect (02-12)
	303-193/21-104, 303-393, 21-168, 303-652, 21-230, 23-067/303-095, 21-162B/303-367 303-376

REF



1518

2kg

5x

 Kit ajuste e bloqueio distribuição Ford 1.5

 Kit ajuste Ford 1.5

	1.5
	B-Max (12-18), C-Max (07-15), EcoSport (13-18), Fiesta (02-21), Focus (04-18), Focus C-Max (03-18), Fusion (04-11), Grand C-Max (10-18), Tourneo Courier (14-16)
	303-734 (21-262), 03-735 (212-263), 303-732 (21-260)

Nota: Para códigos de motor, consultar website

Nota: Para códigos de motor, consultar sitio web

REF



1523

650gr

10x

 Kit sincronização Ford 1.2 8V/1.4 16V

 Kit calado Ford 1.2 8V/1.4 16V

	1.2 8V, 1.4 16V
	1.2 Duratec 169A4.000 (FP4)
	Ford: Ka (09-12)
	303-1478, 303-1477, 303-1480, 303-1479

REF



1560

2,4kg

5x

 Kit sincronização Ford Focus CMAX 1.6/2.0
 Kit calado Ford Focus CMAX 1.6/2.0



	1.6/2.0
	G6DA, G6DB, G6DC, HXDA
	Ford Focus C-MAX 1.6 Ti-VCT (03-07)
	303-1059, 303-1054, 303-748, 303-735, 303-1097

REF		
1547	1,3kg	5x

 Kit sincronização Ford 1.4/1.6/1.8/2.0/2.2
 Kit calado Ford 1.4/1.6/1.8/2.0/2.2



	1.4TDCI, 1.6TDCI, 1.8 D/DT 1.8D/TDCI, 2.0 16V, 2.0TDDI, 2.2TDCI
	Fiesta V (04-08), Fiesta IV, Kuga (08), Focus (04-), Focus C (03-), Focus C Max Grand (10-), Ford Fusion (02), Ford Galaxy S (post. 06), Ford Mondeo (93-), Ford S Max (11-), Ford Transit (11-), Ford Transit (00-), Ford Mondeo (03-07)
	21-162B, 303-36, 303-376, 21-163, 303-620, 23-047, 23054-02, 23-019, 21-168, 23-058, 310-084, 21-105, 21-210, 23-029, 23-059, 310-085, 21-260, 303-732, 21-234 / 251, 21-262, 303-734, 21-263, 303-735, 23-020, 23-123, 23-019, 303-1061

Nota: Para códigos de motor, consultar website
Nota: Para códigos de motor, consultar sitio web

REF		
1574	3,5kg	4x

 Kit sincronização Ford 2.2/3.2TDCI
 Kit calado Ford 2.2/3.2TDCI



	2.2 TDCi/ ECONetic, 3.2 TDCi:
	Ford
	303-698 21-251, 303-1587

Nota: Para códigos de motor, consultar website
Nota: Para códigos de motor, consultar sitio web

REF		
1599	750gr	10x

 Kit sincronização Ford 2.2/3.2 TDCI
 Kit calado Ford 2.2/3.2 TDCI



	2.2L/3.2L
	Ranger 3.2L (11-16), Ranger 2.2L (11-15), Transit 2.2L (06-16), Everest 3.2L (15-), Ranger 3.2L (11-)
	303-1478, 303-1477, 303-1480, 303-1479

Nota: Para códigos de motor, consultar website
Nota: Para códigos de motor, consultar sitio web

REF		
1687	720gr	10x

 Kit sincronização Ford 1.4/1.6/1.8/2.0

 Kit calado Ford 1.4/1.6/1.8/2.0

	1.4, 1.6 TDCi, 1.8 Di/TDCi/TDdi, 2.0 TDCi
	F6JA, F6JB, F6JC, HHJA, HHJB, G8DA, HHDA, HHDB, RTN, RTQ, RTP, C9DC, BHDA/B, BHPA, C9DA/B, F9DA/B, FFBA, FFDA, HCPA, HCPB, KKDA, P7PA, P9PA, QYWA, R2PA, R3PA, RWPA, G6DA, G6DB, G6DC, AZWA, QXWA
	Courier 1.4/1.6/1.8 (00-02), Fiesta 1.4/1.6/1.8 (02-09) Focus 1.6/1.8/2.0 (98-00) C-Max 1.6/2.0 (03-08) Fusion 1.4 (02-08) Galaxy 2.0 (06-08), Mondeo 2.0 (07-08), S-Max 2.0 (06-08), Tourneo Connect 1.8 (02-08), Transit Connect 1.8 (02-08)
	21-260 / 303 732, 21-163 / 303 620, 21-210 / 303-507, 21-104/303 193, 21-168 /303 393, 21-229 / 303 651, 21-162B / 303 376, 21-262 / 303 734, 303 1054, 303 748, 303 1097, 303 - 1059, 21-263 / 303 735

REF



1615

3kg

2x

 Kit sincronização Ford 1.0 ecoboost

 Kit calado Ford 1.0 ecoboost

	1.0 ecoboost
	M1JA, SFJA, SFJB, M1DA, M2DA, P4JA, P4JB, XMJA, XMJB, M1JE, M2GA
	B-MAX, C-MAX, EcoSport, Fiesta, Focus, Grand C-Max, Grand Tourneo Connect, Transit Connect, Transit Courier
	303-1606/1, 303-1606/2

REF



1621

1,1kg

8x

 Bloqueio árvore de cames + volante Ford

 Bloqueo de árbol de levas + volante Ford

	1.25, 1.4, 1.6, 1.7, 1.8, 2.0 16V Zetec
	HWDA, HWDB, HXDA
	Ford: C-MAX (07-10), S-MAX (06-12), Galaxy (06-12), Fiesta (95-12), Puma (97-02), Focus (98-11), Focus CMAX (03-07), Mondeo (93-12), Courier (02-06), Tourneo Connect (02-06), Fusion (02-12), Connect (93-10), Kuga (98-01)
	303-376B, 21-162B, 303-620, 21-163, 303-1054, 303-507, 21-210, 303-748, 21-259

REF



8762

290gr

50x

 Kit bloqueio eixo Ford 2.2 DOHC
 Kit bloqueo eje Ford 2.2 DOHC



	DOHC 2.2
	KNBB, KNBA, KNWA, Q4BA
	Galaxy, Mondeo, S-Max (2008-2015)
	303-1328 0190D, 303-1329, 303-1330

REF		
1637	675gr	20x

 Kit sincronização Ford 1.3 CDTI
 Kit calado Ford 1.3 CDTI



	1.3 CDTI
	167A1.000 (FD4) BAAA/B
	KA (08-15)
	104-A EN 46781, EN-46785

REF		
1511	1,2kg	5x

 Kit bloqueio árvore de cames Ford 1.6
 Kit bloqueo árbol de levas Ford 1.6



	1.6
	167A1.000 (FD4) BAAA/B
	B-MAX (2012), C-MAX (2010), Fiesta (2013), Focus (2011), Galaxy (2010), Grand C-MAX (2010), Kuga (2013), Mondeo (2010), S-MAX (2010), Tourneo Connect (2013), Transit Connect (2013)
	303-1552

REF		
1654	550gr	10x

 Bloqueio volante motor Ford 1.5/1.6/2.0/2.2
 Bloqueo volante motor Ford 1.5/1.6/2.0/2.2



	1.5/1.6/2.0/2.2
	Ford C-MAX (07-17), S-MAX (06-17), EcoSport (13-17), Edge (15-17), Fiesta (13-17), Focus (04-17), Galaxy (06-17), Kuga (08-17), Mondeo (07-17)
	21-168, 303-1272, 303-393, 303-393-01, 303-393-02

Nota: Para códigos de motor, consultar website
Nota: Para códigos de motor, consultar sitio web

REF		
1656	200gr	10x

 Kit sincronização Ford 1.3 diesel

 Kit calado Ford 1.3 diesel

 Ferr. retenção cambota
 Herr. retención cigueñal

REF 1657F

 Acessórios fixação
 Accesorios fijación

REF 1657S

 Chave retenção
 Llave sujeción

REF 1657A

 Alavanca tensão
 Palanca tensor

REF 1657B

	1.3
	Ford KA
OEM	303 1469, 303-1472, 303-1468

REF

1657



1,8kg



5x

 Kit sincronização Ford 2.0

 Kit calado Ford 2.0

	2.0D EcoBlue TDCi
	YLFS, YMFS, YNFS, YLF6, YMF6, YNF6, YLR6, YMR6, YNR6
	Transit, Transit Custom, Tourneo Custom (2016-)
OEM	303-1643, 303-1637, 303-1650

REF

1661



1,74kg



5x

 Kit sincronização Ford 1.0 gtdi gasolina

 Kit calado Ford 1.0 gtdi gasolina

	1.0
	M1CA, M1CB, M1DA, M1DD, M1JA, M1JC, M1JE, M1JH, M1JJ, M2DA, M2DB, M2DC, M2GA, M2GB, SFCA, SFCB, SFCC, SFCD, SFDB, SFJA, SFJB, SFJC, SFJD, XMJA, YYJB
	B-Max (12-17), C-Max (12-17), EcoSport (13-17), Fiesta (13-17), Focus (12-17), Grand C-MAX (12-17), Grand Tourneo Connect (13-17), Mondeo (15-17), Tourneo Connect (13-17), Transit Connect (13-17), Transit Courier (14-17)
OEM	303-1602, 303-1604, 303-1054, 303-732, 303-1603

REF

1721



1,74kg



5x

 Ferramenta alinhamento polia cambota Ford ecoboost 1.5
 Herramienta de alineación polea cigüeñal Ford ECOBOOST 1.5



	1.5
	JQDA, JQDB, JTDA, JTDB, JTBA, JTBB, JTWA, JTWB, JQ
	Focus B-Max (10-14), C-Max (10-14), Grand C-Max
	303-1550

REF

1734



45gr



1x

 Extrator polia cambota ford ecoblue 2.0
 Extractor polea cigüeñal ford ecoblue 2.0



	2.0
	FWD Transit, RWD Transit
	Ford Kuga, Ranger, Transit Custom (19-)
	303-1657

REF

1724



291gr



48x

 Instalador do retentor dianteiro da cambota Ford 1.0
 Instalador junta de la tapa delantera Ford 1.0



	1.0
	Ford KA
	303-1603

REF

1705



440gr



50x

 Kit bloqueio Ford 1.0 ecoboost
 Kit bloqueo Ford 1.0 ecoboost



	1.0
	M1DD, M1JA, M1JC, M1JE, M1JH, M1JJ, M1DA, M2DA, M2DB, M2DC, SFDB, SFJA, SFJB, SFJC, SFJD
	Fiesta, Focus, B-MAX, EcoSport
	303-1605, 303-1606, 303-1604, 303-1602, 303-393A, 21-168, 303-1054

REF

1676



5,25kg



2x

-  Desmultiplicador 5:1 para motores Ford ecoboost 1.0/1.1/2.0
 Multiplicador de par 5:1 para motores Ford ecoboost 1.0/1.1/2.0



	1.0 EcoBoost, 1.0 Duratec, 1.1 Duratec, 2.0 Duratorq-TDCi, 2.0 EcoBlue Diesel
	M1DA, M1DD, M1JA, M1JC, M1 JE, M1JH, M1JJ, M1CA, M1CB, M2DA, M2DB, M2DC, M2GA, M2GB, P4JA, P4JB, P4JC, P4JD, SFCA, SFCB, SFCC, SFCD, SFDB, SFJA, SFJB, SFJC, SFJD, XMJA, XMJB, XMJC, XMJD, YYJA, YYJB
	Ford B-Max (12-18). Ford C-Max (12-18). Ford Grand C-Max (17-18). Ford EcoSport (15-19), Ford Fiesta (12-19), Ford Focus (12-18), Ford Mondeo (15-18), Ford Transit Courier (14-20), Ford Transit Connect (13-18), Ford Grand Tourneo Connect (13-18), Ford Tourneo Courier (14-20)
	303-1611. 303-1611-01.303-1611-02

REF		
8202	8kg	1x

-  Kit sincronização 1.5T 3 cilindros Ford
 Kit calado 1.5T 3 cilindros Ford



	1.5T
	Ecosport, Fiesta, Focus
	303-1639, 303-1643, 303-1647, 303-1648

REF		
1698	2,3kg	5x

-  Chave tensor correia Ford 1.4/1.6
 Llave tensor correa Ford 1.4/1.6



 **Aplicação:** Esta ferramenta permite a remoção / instalação da correia em V no veículo mesmo em espaços reduzidos
 Facilita o pré-tensionamento e o bloqueio das correias em V
Motores: Ford 1.4/1.6

 **Aplicación:** Esta herramienta permite la extracción / instalación de la correa en V en el vehículo incluso en espacios reducidos
 Facilita el pretensado y bloqueo de los tensores de correas en V
Motores: Ford 1.4/1.6

REF		
2897	725gr	20x

 Kit sincronização Jaguar Land Rover 2.0 diesel
 Kit calado Jaguar Land Rover 2.0 diesel



	2.0
	AJ-200D, 204DT, 204DTA; AJ200D, AJ200, 204DTA, 204DTD
	Jaguar: E-Pace (17-), F-Pace (16-) XE (15-), XF (15-), 2.0T gasolina (2021-2022-2023) Land Rover: Discovery (17-) Discovery Sport (15-19), Land Rover Evoque T204 (15-17), Land Rover Evoque, XEL/XFL Range Rover: Evoque (15-19), Range Rover Sport (16-18), Range Rover Velar (17-)
	303-1625, 303-1631, 303-1630, 303-1627

REF		
1693	5,25kg	2x

 Kit sincronização Jaguar / Land Rover V8 5.0
 Kit calado Jaguar / Land Rover V8 5.0

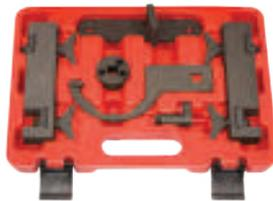

	V8 5.0
	X150-XK (2010), X250-XF, (2010), X351-XJ (2010)
	303-1145, 303-1447, 303-1148, 303-1452, 303-1482

REF		
1616	5kg	2x

 Kit remoção/instalação veio equilíbrio JLR 2.0 Diesel
 Kit remoción/instalación eje de equilibrio JLR 2.0 Diesel



	2.0
	AJ20/204DT, AJ20/204DTA, AJ-200D/204DT, AJ-200D, AJ-200D/204DTA, 204DTA, AJ-200/204DTD
	Jaguar: E-Pace (17-), F-Pace (16-20), XE (2015-2020), XF (15-20) Land Rover: Discovery (2017-), Discovery Sport (15-19), Range Rover Evoque (15-19), Range Rover Sport (16-18), Range Rover Velar (17-)
	JLR-303-1662, JLR-303-1663-1, JLR-303-1663-2, JLR-303-1663-3, JLR-303-1664 e JLR-303-1665

REF		
1703	6,5kg	2x

 Kit bloqueio volante motor Jaguar / Land Rover
 Kit bloqueio volante motor Jaguar / Land Rover



	Jaguar: F-Tipo, XF XFR / S, XJ, XJR, XK8, XKR Land Rover: Discovery 4, Discovery Range Rover, Range Rover Sport
	303-1304, 303-1448

REF		
1634	560gr	25x

-  Kit bloqueio bomba combustível Jaguar / Land Rover 3.0
 Kit bloqueo bomba combustible Jaguar / Land Rover 3.0



	3.0
	Jaguar: XF, XJ Land Rover: Discovery 4, Range Rover, Land Rover 3.0 TDV6, Range Rover Sports (09-14)
	310-212

REF



1635

160gr

100x

-  Kit extrator polia cambota JLR 3.0L V6 & 5.0L V8
 Kit extractor polea cigüeñal JLR 3.0L V6 & 5.0L V8



	3.0L/5.0L
	3.0L AJ-126/306PS, 5.0L AJ133/508PS, 508PN
	Jaguar: F-Type, XE, XF, XFR, XJ, XJR, XK8, XKR (09-18) Land Rover: Discovery 4/Discovery, Range Rover, Range Rover Sport (09-18)
	303-1437, 303-1438, 303-1439, 303-1439, 303-1440, 303-144

REF



1711

7,8kg

1x

-  Extrator polia cambota 125mm Jaguar / Land Rover JLR
 Extractor polea cigüeñal 125mm Jaguar / Land Rover JLR



	JLR
	Jaguar: X200 S, X250 XF, X350 XJ, X351 XJ (300 powertrain) Land Rover: Sport TDV6 (3 Powertrain)

REF



1638

2,58kg

5x

-  Kit sincronização Jaguar / Land Rover 2.0 GTDI
 Kit calado Jaguar / Land Rover 2.0 GTDI



	2.0
	AJ200/204PT
	Jaguar: XE, XF GTDi, XJ GTDi Land Rover: Land Rover Discovery Sport, Si4, Freelander 2, Si4, Range Rover Evoque Si4
	Jaguar: 303-1600, 303-1595, 303-1594, 303-748, 303-1521 Land Rover: 303-1600, 303-1595, 303-1594, 303-748, 303-1901A

REF



1648

2,05kg

5x

 Kit sincronização Jaguar / Land Rover / Citroën 2.7 / 3.0 Td V6
 Kit calado Jaguar / Land Rover / Citroën 2.7/3.0 TD V6



	2.7/3.0 TD V6
	276DT, DT17BTED4, D20CTED4
	Jaguar: S-Type (04-08), XF (08-12), XJ (10-12), XJ6 (05-10) Land Rover: Discovery III (04-09), Discovery IV (09-12), Range Rover Sport (05-09)
	303-1117, 303-1116, 303-1132, 303-1126 0195-H, 0195-C, 0195-K, 0188-K

REF		
1658	1,6kg	5x

 Kit sincronização Land Rover 2.5 TD5
 Kit calado Land Rover 2.5 TD5



	2.5D TD5
	Land Rover
	17 4 T1/25 6 T1

REF		
1534	5,75kg	2x

 Kit sincronização Land Rover 1.6 gasolina
 Kit calado Land Rover 1.6 gasolina



	1.6 gasolina
	N40 B16A / N45 B16A / B16AC, N45 B16A / B16AC, N45T B16
	Land Rover
	1 7 260, 1 7 251, 11 9 340 / 11 9 341, 1 7 252, 1 9 190

REF		
1539	2,4kg	5x

 Kit sincronização Land Rover 2.0D
 Kit calado Land Rover 2.0D



	2.0D
	20 4D 1, 20 4D 4, 25 6D 1, 25 6D 2, 30 6D 1, 30 6D 2, 30 6D 3, 30 6D 4, 30 6D 5
	Land Rover Freelander 00-06, Rover 75 2.0D
	11 6 320, 11 3 340, 11 6 322, 11 2 300

REF		
1501	1,7kg	5x

 Kit sincronização Land Rover 2.5 TDI

 Kit calado Land Rover 2.5 TDI

	2.5 TDI
	Land Rover 2.0
	11 6 320, 11 6 322, 13 5 120, 11 2 300, 11 3 340 13 5 191, 13 5 192, 13 5 190, 11 5 180, 11 6 080

REF

1538



5,1kg



2x

 Kit sincronização Land / Range Rover 3.6 V8 diesel

 Kit calado Land / Range Rover 3.6 V8 diesel

	3.6 V8
	368DT
	Range Rover, Range Rover Sport (06-11)
	303-1236, 303-1243, 303-1239, 303-1238

REF

1629



2kg



5x

 Kit bloqueio eixo Land Rover 2.2 DOHC

 Kit bloqueio eje Land Rover 2.2 DOHC

	DOHC 2.2
	224DT, DW12CTED4/224DT, DW12BTED4/224DT
	Land Rover: Discovery, Discovery Sport, Freelander 2
	303-1328 0190D, 303-1329, 303-1330

REF

1637



675gr



20x

 Kit sincronização Jeep/Chrysler 2.8L CRD

 Kit calado Jeep/Chrysler 2.8L CRD

	2.8L CRD
	Jeep: ENS (VM49C/50C/10D/11D), ENS (VM12D/13D/51C/52C) Chrysler: ENS (VM64C)
	Jeep: Wrangler (07-11), Cherokee (08-13) Chrysler: Grand Voyager (08-15)
	EN-50030 / VM-9992, EN-51025, EN-51104, EN-50029 / VM-9991

REF

1607



1,3kg



5x

 Kit sincronização Jeep/Chrysler 2.2/2.7
 Kit calado Jeep/Chrysler 2.2/2.7



	2.2/2.7
	Jeep: PT Cruiser Chrysler: Grand Cherokee
	601589024000 / 8933, 602589004000 / 8929, 602589004000 / 8529

Nota: Para códigos de motor, consultar website
Nota: Para códigos de motor, consultar sitio web

REF		
1559	1,2kg	10x

 Descravador corrente motor Jeep/Chrysler 2.2/2.7/3.0D CRD
 Extractor de pasadores motor Jeep/Chrysler 2.2/2.7/3.0D CRD



	2.2D/2.7D/3.0D/CRD
	Jeep, Chrysler
	602589026300, 103589016300, 112589069300, 602589023300, 602589046300, 602589003900, 602589046301, 602589024000

REF		
1609	3,3kg	5x

 Kit sincronização Chrysler 2.5/2.8CRD
 Kit calado Chrysler 2.5/2.8CRD



	2.5/2.8
	Voyager (01-08), Grande Voyager (01-08)
	VM 1068 LDV 196, VM 1089 LDV 196, VM 1053 LDV 193, VM 1052 LDV 192, VM 1074, VM9660 H2587

REF		
1576	1,3kg	5x

 Kit sincronização Mercedes M112/M113
 Kit calado Mercedes M112/M113



	M112/M113
	Classe C 2.4, 2.6, 2.8, 3.2, 4.3 (98-00); CLK 3.2, 4.3, 5.4 (97-03); Classe E 2.4, 3.2, 4.3, 5.5 (97-03), Classe-C 2.6, 3.2 (02-06); Classe-E 2.6, 3.2 5.0 (02-06), Classe-S 3.7, 4.3, 5.0 (02- 06)
	VM 1068 LDV 196, VM 1089 LDV 196, VM 1053 LDV 193, VM 1052 LDV 192, VM 1074, VM9660 H2587

REF		
1522	870gr	10x

 Ferramenta bloqueio bomba diesel Mercedes 2.0/2.5/3.0
 Herramienta bloqueo bomba diesel Mercedes 2.0/2.5/3.0



	2.0/2.5/3.0
	OM601, OM602, OM603, OM605, OM606, OM617
	200D, E200D, 250D, E250, E250D, E250, 250D, E250, 300D, E300, 200TD, 300TD, 190D

REF		
1533	70gr	50x

 Kit sincronização Mercedes motores M271 1.8
 Kit calado Mercedes motores M271 1.8



	1.8
	271.921, 271.946, 271.942, 271.948, 271.820, 271.95, 271.860, 271.950, 271.955, 271.957, 271.941, 271.956, 271.943, 271.958, 271.944, 271.964, 271.861, 271.95
	Classe C (02-15), Classe C Coupe (11-15), Classe CLC (08-12), CLK (02-09), Classe E (02-13), Classe E Coupe Cabriolet (04-13), SLK (04-15), Sprinter (09-15)
	271 589 00 61 00, 271 589 00 31 00, 271 589 01 40 00, 271 589 00 15 00

REF		
1549	2,8kg	2x

 Kit sincronização Mercedes 1.8/2.0/2.1/2.2.2.3, 2.5, 2.7, 2.8, 2.9, 3.0, 3.2, 3.5
 Kit calado Mercedes 1.8/2.0/2.1/2.2/2.3/2.5/2.7/2.8/2.9/3.0/3.2/3.5



	1.8/2.0/2.1/2.2/2.3/2.5/2.7/2.8/2.9/3.0/3.2/3.5 (83-07)
	Mercedes
	601589024000 / 8933, 602589004000 / 8929, 602589004000 / 8529

Nota: Para códigos de motor, consultar website
Nota: Para códigos de motor, consultar sitio web

REF		
1559	1,2kg	10x

 Tensionador correia Poly V - Mercedes W169 & W245
 Tensor de correa Poli V - Mercedes W169 & W245



 **Características:**
 Concebida para apertar e desapertar a mola do amortecedor sem a danificar
 Fuso com cabeça esférica
 Acionamento: hexágono interior 10mm
 Tensionador para MERCEDES W169 e W245 (Alternador com função Start-Stop)

 **Características:**
 Diseñado para apretar y aflojar el muelle del amortiguador sin dañarlo
 Husillo con cabeza esférica
 Accionamiento: hexágono interior 10mm
 Tensor para MERCEDES W169 y W245 (Alternador con función Start-Stop)

REF		
1710	382gr	50x

 Ferramenta bloqueio bomba diesel Mercedes 602,604,605
 Herramienta bloqueio bomba diesel Mercedes 602,604,605



	OM602, OM604, OM605, OM606 bomba lucas
	Mercedes

REF		
1546	33gr	100x

 Kit sincronização Mercedes M270/M274 1.6/2.0
 Kit calado Mercedes M270/M274 1.6/2.0



	1.6/2.0
	Classe A 1.6/2.0 (12-), Classe B 1.6/2.0 (12-), CLA 1.6/2.0 (12-), Classe C 1.6/2.0 (11-), Classe C Coupe 1.6/2.0 (11-), Classe C Coupe 1.6/2.0 (11), Classe E 1.6/2.0 (11-)
	270 589 00 61 00, 270 589 00 61 00, 270 589 00 61 00

REF		
1600	1,3kg	5x

 Kit sincronização Mercedes M651 1.8/2.1
 Kit calado Mercedes M651 1.8/2.1



	1.8/2.1 CD
	Classe A 1.8, Classe B 1.8, Classe C 2.1, Classe C Coupe 2.1, CLA 1.8/2.1, CLS 2.1, Classe E 2.1, Classe E Coupé 2.1, GLK 2.1, Classe M 2.1, Classe S 2.1, SLK 2.1, Sprinter 2.1 Viano 2.1, Vito 2.1
	651 589 00 40 00, 651 589 01 40 00

REF		
1604	1,9kg	5x

 Bloqueio volante motor Mercedes 1.5D/1.6P/2.0P
 Bloqueo volante motor Mercedes 1.5D/1.6P/2.0P



	1.5D/1.6P/2.0P
	Mercedes-Benz classe A (13 - 19), classe B (12 - 19), CLA (13 - 19), GLA (14 - 20)
	270 589 00 40 00

REF		
1688	320gr	24x

 Kit sincronização Mercedes M642 CDI Kit calado Mercedes M642 CDI			M642 CDI
			Classe C W203 / S203 (00-07), W204 / S204 (2007-), CLK C209 / A209 (02-10), CLS C218 / C219 (04-), Classe E W211 / S211 (02-09), W212 / S212 (09-), C207 / A207 (09-), Classe S W221 / W222 (2005-), Classe M W164 / W166 (05-), Classe R W251 / V251 (06-), Class G W461 / W463 (09-), Classe GL X164 / X166 (06-), Viano W639 (2003-), Sprinter 906 (2006-), Vito V639 (2006-)
			642 589 00 31 00

REF

1691



800gr



10x

 Kit sincronização Mercedes Kit calado Mercedes			CL 500/63 AMG (C216), S 500 / 63 AMG (C217), CLS 300 (C218), E300 /350 / 400 (C/A 207), CLS 350 / 400 / 500 /63 AMG (C/X 218) SLK 350 (R 172), SL 350 / 400 / 500 / 63 AMG (R 231), S 500 PLUG-IN HYBRID (V 222) ML 300 / 350 / 500 / 63 AMG (W 166), C 400 (W 205), E 400 HYBRID (W 212), G 63 AMG (W 463), E 300 / 350 / 400 / 500 / 63 AMG (W/S 212), C 350 (W/S/C 204), S 350 / 500 / 63 AMG (W/V 221), S 400 / 63 AMG (W/V 222) R 350 BlueEFFICIENCY (W/V 251), GL 450 / 500 (X 166), GLK 350 (X 204)
			0276589014000

REF

1614



850gr



10x

 Descravador corrente motor Mercedes diesel/gasolina Extractor de pasadores motor Mercedes diesel/gasolina			615/616/617/M102/M103/116/272/273/274, 276/1.7D/2.1D/2.2D/2.7D/3.0D/3.2D/3.9D, 4.0CDi
			Mercedes
			602589026300, 103589016300, 112589069300, 602589023300, 602589046300, 602589003900, 602589046301, 602589024000

REF

1609



3,3kg



5x

 Kit sincronização Mercedes 1.6 CDi Kit calado Mercedes 1.6 CDi			1.6 CDi
			205/447
			Classe C (14-18), Vito (14-)
			MOT1969, MOT1970, MOT1770, MOT1773, EN-48330, EN-48332, EN-48334, EN-48831, KM-6130

REF

1620



2,4kg



5x

 Kit sincronização 1.6/2.0 Diesel Mercedes
 Kit calado 1.6/2.0 Diesel Mercedes



	1.6/2.0
	654.916, 654.920
	Classe A (19-), Classe B (19-), Classe C (18-), CLA (19-), CLS (18-), Classe E (16-), GLB (19-), GLC Coupe (19-), GLE (19-), V Classe (19-), Vito (19-)
	W654 589 00 40 00, W654 589 01 40 00, W654 589 00 21 00

REF		
1681	2,6kg	5x

 Kit drenagem óleo transmissão Mercedes 9G tronic
 Kit drenaje aceite transmission Mercedes 9G tronic



	E 350 BlueTEC (13-), CLS (14-)
	725 589 00 90 00, 725 589 02 90 00

REF		
1639	87gr	40x

 Bloqueio árvore de cames Mercedes 1.8/2.1/2.2
 Bloqueo árbol levas Mercedes 1.8/2.1/2.2



	1.8/2.1/2.2
	Mercedes M651 (12-)
	651589094000

REF		
1655	620gr	20x

 Jogo 4pcs ajustadores árvore cames Mercedes-Benz M152/M157/M276/M278
 Ajustador del árbol de levas 4pzs - Mercedes-Benz M152/M157/M276/M278



	M152/M157/M276/M278
	Mercedes
	278589002300

REF		
1714	342gr	10x

-  Kit bloqueio motor Mercedes M177/M178
 Kit bloqueio motor Mercedes M177/M178



	4.0L
	M177, M178
	Mercedes Benz AMG C63, C63S biturbo 4.0L, V8
	177589014000, 177589001500

REF

1674



9kg



2x

-  Kit sincronização Mercedes M651
 Kit calado Mercedes M651



	180CDi/200CDi/220CDi/250CDi/ 210CDi/310CDi/510CDi/ 213CDi/313CDi/216CDi/ 316CDi/ 416CDi/2.0CDi/2.2CDi/110CDi/ 113CDi/ 116CDi/250/300 Blue TEC
	M651
	Mercedes Benz M651, Mercedes A, B, C, CLA, CLS, E, GLK, M, S, SLK, Sprinter, Viano, Vito
	651 589 00 4000, 651 589 01 4000651 589 09 4000, 651 589 03 4000, 651 589 03 4000

REF

1678



3,34kg



5x

-  Bloqueio volante motor Mercedes M651 1.8/2.1
 Bloqueio volante motor Mercedes M651 1.8/2.1



	1.8/2.1
	M651
	Classe A, B, C, CLA, E, GLA, GLK, V
	651 589 02 40 00

REF

8763



900gr



72x

-  Kit sincronização volante motor Mercedes 0.9/1.3/1.6 Gasolina
 Kit bloqueio para volante motor Mercedes 0.9/1.3/1.6 Gasolina



	0.9/1.3/1.6
	Classe A (18-); Classe B, CLA, GLA, GLB (19-)
	2188

REF

1702



940gr



10x

-  Kit bloqueio Mercedes 1.3 gasolina
 Kit calado Mercedes 1.3 gasolina



	1.3
	M 242.914
	Classe A, B, CLA, GLA, GLB (18-)
	282 589 00 23 00

REF		
1694	1,55kg	10x

-  Kit sincronização Renault Universal
 Kit calado Renault Universal



	1.5/1.9/2.5/2.8
	Avantime, Clio, Espace, Kangoo, Laguna, Master, Megane, Modus, Scenic, Twingo, Traffic
	MOT1543, MOT1537, MOT1705, MOT1534, MOT1801, MOT1538 / 1430, MOT1536, MOT861 / 863, MOT 1200-01, MOT1348, MOT1312, MOT1384, MOT1337, MOT1496, MOT1135-01, MOT1340, MOT1386, MOT910, MOT910, MOT1536

REF		
1519	5,9kg	2x

-  Kit sincronização Renault DCI 1.5D/1.9D/2.2D/2.5D
 Kit calado Renault DCI 1.5D/1.9D/2.2D/2.5D



	1.5D/1.9D/2.2D/2.5D
	K9K, F9Q, G9T, G9U
	Clio II/Campus/Storia (01-11) Clio III (05-11) Espace/Grand Espace (00-02), Espace/Grand Espace IV (02-09), Fluence (09-12), Kangoo (00-09), Kangoo Trekka (01-05), Kangoo II/Be-Bop (08-12) Laguna (99-01), Laguna II (01-07), Laguna III (07-12), Logan/Logan MCV (05-11), Master II (01-10), Megane (99-03) Megane II (02-10), Megane III (08-12), Modus (04-08), Modus/Grand Modus II (08-11), Scenic/RX4 (99-03) Scenic/Grand Scenic II (03-09) Scenic/Grand Scenic III (09-11), Traffic II (01-12) Twingo II (07-10) Vel Satis (02-09).
	MOT1537, KM-6204, KM-6234, MOT1534, KM6205, MOT1534, KM6205, MOT1054, MOT1536, KM6203, MOT1489

REF		
1513	3kg	2x

 Kit sincronização Renault 2.2/2.5 DCI
 Kit calado Renault 2.2/2.5 DCI



	2.2/2.5 DCI
	G9U, F9Q, Z22SE, Z22YH
	Espace 2.2DCI, Master 2.2/2.5DCI, Laguna, Scenic, Megane, Avantime, Trafic, Master, Espace
	MOT 1538, KM 6203/MOT 1536, KM 6204/MOT 1537, KM 6148, MOT 1537/KM 6204

REF

1542



3,7kg



2x

 Kit bloqueio Renault 1.3 gasolina
 Kit calado Renault 1.3 gasolina



	1.3
	H5H
	Arkana (19-), Captur (18-), Clio V (19-), Kadjar (18-), Megane (17-), Scenic (18-) e Talisman (18-)
	282 589 00 23 00

REF

1694



1,55kg



10x

 Kit sincronização volante motor Renault/Dacia 0.9/1.3/1.6 Gasolina
 Kit bloqueio para volante motor Renault/Dacia 0.9/1.3/1.6 Gasolina



	0.9/1.3/1.6
	Renault: Arkan, Clio V (19-), Captur, Kadjar, Megane IV, Scenic e Talisman (18-) Dacia: Dokker, Lodgy (19-), Duster (18-)
	2188

REF

1702



940gr



10x

 Jogo bloqueio polia cambota 0.9/1.0/1.2/1.6 TCe Renault/Dacia
 Herramienta bloqueio polea cigueñal 0.9/1.0/1.2/1.6 TCe Renault/Dacia



	0.9/1.0/1.2/1.6 TCe
	0.9TCe: H4B 453, H4Bt 400, 401, 408, 410, 411, 451 1.0TCe: H4D, H4D 400, 450, 460, 470 1.2TCe: H5Ft 400, 403, 404, 405, 408, 410, 412 1.6TCe: H4M 429, 438, 440, 729, 730, 738, 740, 748, 749
	Renault: Arkana, Captur, Clio, Fluence, Kadjar, Kangoo, Megane, Scenic, Twingo Dacia: Dokker, Duster, Lodgy, Logan, Sandero
	281589004000, MOT.2006, MOT.2054

REF

1722



1,06kg



50x

 Kit sincronização Renault/Nissan 1.6/1.7 DCI
 Kit calado Renault/Nissan 1.6/1.7 DCI



	1.6/1.7dCi
	Renault: JFC)/(HFE)/(HZG) (BFB/KFB/LFF)/(J95), (JFA/RFA)/(KFD/LFD) (E/F/J82) Nissan: (J11)(J10)/T32
	Renault: Espace V(15-), Kadjar, Koleos II (17-), Megane III(12-14), Megane IV (16-), Scenic Grand Scenic III (09-), Scenic Grand Scenic IV (16-), Talisman (15-), Trafic III (14-) Nissan: Qashqai (14-), Qashqai, Qashqai +2, X-Trail(14-)
	2.041.600.090; 2.041.800.090; 2.041.900.090; 626 589 00 15 00; 626 589 02 40 00; 626 589 04 40 00; EN-48331; EN-48334; EN-51241; EN-51248; Mot.1770; Mot.1773; Mot.1969; Mot.1970

REF		
1620	2,4kg	5x

 Kit sincronização Renault/Nissan 2.0/2.3 CDi/DCI
 Kit calado Renault/Nissan 2.0/2.3 CDi/DCI



	2.0 , 2.3CDi/DCI
	Renault: M9r 700,721,724,740,742,446,760, 761,780,802,803,805,830,832,833 Nissan: M9r 780, 830, 832, 833
	Renault: Espace IV (06-15), Grand Espace IV (06-15), Koleos (08-15), Laguna II (05-07), Laguna III (09-15), Latitude (06-10),Megane II (06-10), Megane III (09-15), Scenic II (06-09), Grande Scenic II (06-09), Scenic III (09-15), Grand Scenic III (09-15), Traffic II (06-15), Master III (10-16), Espace V (15-16), Fluence (15-16), Megane III (12-16), Traffic III (14-16) Nissan: Primastar DCI (06-15), Qashqai / Qashqai +2 CDTI (07-14), XTrail (07-14), NV400 (11-16), Qashqai (14-16), X-Trail (14-16)
	EN-48334/MOT 1770, EN-48330/MOT 1766, KM-6130, EN-48332/MOT 1769, EN-17697EN-48331

REF		
1551	2,3kg	5x

 Kit sincronização Renault 2.0/2.5
 Kit calado Renault 2.0/2.5



	Laguna. 2.0 16V (96-01) Safrane: 2.0 16V (96-01), Safrane 2.5 16V (96-01)
	N7Q 700, N7Q 704, N7Q 710, N7Q 711 N7U 700, N7U 701
	Laguna (96-01), Safrane 2.5 (96-01)
	MOT 1489, MOT 1340, MOT 1348

REF		
1578	1,8kg	5x

 Kit sincronização Renault 1.4/1.6/1.8/2.0
 Kit calado Renault 1.4/1.6/1.8/2.0



	1.4/1.6/1.8/2.0
	K4J, K4M, F4P, F4R, F5R
	Clio II/III, Espace IV, Kangoo, Laguna II/III, Megane II, Modus, Scenic, Grand Scenic, Traffic II, Modus
	MOT 1489, MOT1490-01, MOT 1054, MOT 1496

REF

1563



2,4kg



5x

 Kit sincronização Renault/Nissan 1.4/1.6/2.0
 Kit calado Renault/Nissan 1.4/1.6/2.0



	1.4/1.6/1.8/2.0
	Renault: Clio II (99-06), Clio III/Sport (05-12) Espace/Grand Espace (98-02), Espace/Grand Espace IV (02-10), Kangoo/Trekka (01-09) Laguna (98-01), Laguna II (01-07), Laguna III (07-10), Megane (99-03), Megane II (02-10) Megane III/Sport (08-12), Megane/Scenic (99-00), Scenic/RX4(99-03), Scenic/Grand Scenic II (03-09), Traffic II (01-11) Nissan: Kubistar X76 (03-09), Primaster X83 (02-11)
	1054, 1489, 1496

Nota: Para códigos de motor, consultar website

Nota: Para códigos de motor, consultar sitio web

REF

1587



1,8kg



5x

 Kit sincronização Renault/Nissan 1.5/1.9DCI
 Kit calado Renault/Nissan 1.5/1.9DCI



	1.5/1.9DCi
	K9K (02-10), F8Q/ F9Q.
	Renault: Renault Laguna, Kangoo, Clio Nissan: Almera, Kubistar, Micra
	MOT 1489, MOT 1430, 0187B, 21-263, 0132AJ1, 303-735, 49 JE02 021, 303-1277, 0188M, 999-7122, 999 7122, 0189B, 0194B, MOT 863, KM6031, MOT 1054, MOT861

REF

1588



245gr



100x

 Chave de velas 3/8" estriada 14mm Renault
 Llave de bujias 3/8" estriada 14mm Renault

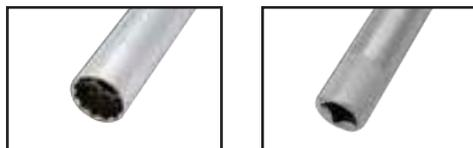

	Renault
---	---------

REF

1581



14mm



250mm



225gr



40x

-  Kit bloqueio polia volante dianteiro Renault/Nissan 1.4/1.6/2.0/2.5/3.5
 Kit bloqueio polea volante delantero Renault/Nissan 1.4/1.6/2.0/2.5/3.5



Nota: Para códigos de motor, consultar website
Nota: Para códigos de motor, consultar sitio web

	1.4/1.6/2.0 /2.5/3.5
	Renault: Espace V (15-16), Clio (06-16), Fluence (09-15), Laguna (05-15), Latitude (10-16), Megane (06-15), Scenic/Grand Scenic (06-15), Espace/Grand Espace IV (02-15), Koleos (08-16), Trafic II (07-15), Vel Satis (00-10), Master III (10-16) Nissan: Primastar (06-15), Qashqai/Qashqai+2 (07-14), X-Trail (07-14), NP300 Navara (15-16), NV400 (11-16)
	MOT 919-02, MOT 1431, MOT 1716, MOT 2019, MOT 1789

REF
8764

2kg

5x

-  Kit sincronização Renault 2.5D/2.8D
 Kit calado diesel Renault 2.5D/2.8D



	2.5D/2.8D
	Mascot (99-07), Master (89-98), Master II (98-01), Trafic (80-00)
	OEM2 MOT 861 MOT 1054 MOT 863

REF
1706

140gr

96x

-  Kit sincronização Opel 1.6/1.7
 Kit calado Opel 1.6/1.7



	1.6/1.7
	Astra, Belmont, Kadett E 1.6/1.7D, Astravan, Astramax 1.6/1.7D, Cavalier, Ascona C, Vectra A 1.6/1.7D, Astra F 1.7D/TD, Astra G 1.7TD, Astravan 1.7D, Cavalier/Vectra A 1.7D, Nova 1.5TD, Corsa A, Corsa B 1.5TD/1.7D, Corsavan/Combo 1.7D, Astra F 1.7TD, Cavalier/Vectra A 1.7TD, Vectra B 1.7TD, Frontera 2.8TD, Monterey 3.0TD/3.1TD, Brava 2.3D/2.5D/TD
	KM 571-B, KM 951, KM 661-2

REF
1509

1,6kg

5x

-  Kit sincronização Opel 1.0/1.4/1.5
 Kit calado Opel 1.0/1.4/1.5



Nota: Para códigos de motor, consultar website
Nota: Para códigos de motor, consultar sitio web

	1.0/1.4/1.5
	Adam (14-19), Adams Rocks (14-19), Astra - K (15-19), Corsa - E (15-19), Insignia B (17-20), Mokka X (16-19), Viva (Karl) (15-20)
	EN-51632, EN-51367, EN-51298

REF
1649

2,2kg

5x

 Kit sincronização Opel 2.0/2.2 turbo
 Kit calado Opel 2.0/2.2 turbo



	2.0/2.2
	X20DTH,X20DTL,Y20DTH, Y20DTL.2.2D - X22DTH, Y22DTH, Y22DTR
	Vectra B, Sintra, Zafira, Frontera B
	KM-933, KM-927, KM-929, KM-932, KM-933

REF		
1503	2kg	5x

 Kit bloqueio Opel 1.6 SIDI
 Kit calado Opel 1.6 SIDI



	1.6 SIDI
	LVP/A16XHT, LWC/A16SHT, LVP/B16XHT, LWC/B16SHT, LWC/A16SHL
	Cascada, Astra J, Zafira C, Insignia (13-16)
	EN-51148, EN-51147, EN-51153, EN-50513

REF		
1695	3,7kg	5x

 Kit sincronização Opel 1.3/1.9 CDTI
 Kit calado Opel 1.3/1.9 CDTI



	1.3/1.9 CDTI
	Agila 1.3 CDTI D, Astra H 1.3 CDTI D, Combo C 1.3 CDTI D, Corsa C 1.3 CDTI D, Meriva, Tigra B 1.3 CDTI D, Astra 1.9 CDTI D, Astra H 1.9 CDTI D, Signum 1.9 CDTI D, Vectra C 1.9 CDTI D, Zafira B 1.9 CDTI D
	EN-46788, 1 860 905 000, EN-46785, 1 860 905 000, KM 6130, KM-6349, EN-46785, EN-46789, EN-46781, EN-46789-100

REF		
1510	1,9kg	5x

 Kit sincronização Opel 1.0/1.2/1.4 16V
 Kit calado Opel 1.0/1.2/1.4 16V



	1.0/1.2/1.4
	Z12XE, Z10XEP, Z12XEP, X10XE,X12XE Z14XEP, Z14XEL
	Agila(04), Agila (03-08), Corsa-B (97-00), Corsa Combo-C (03-09), Astra-G (98-04), Astra-G (03-06), Astra-H (04-09), Tigra-B (04-09), Meriva (04-09)
	KM-953, KM-952, KM-954, KM 955, KM-955

REF		
1508	1,4kg	5x

 Kit sincronização Opel 1.9D CDTI/TID/TTID, 2.0CDTI/ecoFLEX
 Kit calado Opel 1.9D CDTI/TID/TTID, 2.0CDTI/ecoFLEX



	1.9D CDTI/TID/TTID, 2.0CDTI/ecoFLEX
	Astra H (04-11), Astra J (10-12), Insignia (08-12), Signum (04-08), Vectra C (04-08), Zafira (05-12)
	EN-46788, EN-46789, KM 6130 KM 6349

Nota: Para códigos de motor, consultar website
Nota: Para códigos de motor, consultar sitio web

REF		
1532	1,8kg	5x

 Kit sincronização Opel 1.9D DTI/1.9D CDTI/2.2D DTI/2.5D DTI
 Kit calado Opel 1.9D DTI/1.9D CDTI/2.2D DTI/2.5D DTI



	1.9D DTI/1.9D CDTI/2.2D DTI/2.5D DTI
	K9K, F9Q, G9T, G9U
	Movano A (00-10), Vivaro (01-12).
	MOT1537, KM-6204, KM-6234, MOT1534, KM6205, MOT1534, KM6205, MOT1054, MOT1536, KM6203, MOT1489

REF		
1513	3kg	2x

 Kit sincronização Opel 1.4/1.6/1.7/1.3/1.9/1.6/1.8/2.0/2.2
 Kit calado Opel 1.4/1.6/1.7/1.3/1.9/1.6/1.8/2.0/2.2



	1.6L/1.7L/1.3/1.9CDTI/1.6/1.8/2.0 16V/1.4/ 2.0/2.2D turbo, 2.2 DTI
	Opel Agila 1.0/1.2, Astra G 1.2i, Corsa B 1.0i, 1.2i
	KM 927, KM 933, KM 955, EN-46788, 1 860 905 000, KM 6148, KM 953, KM 517B, KM 953, EN-46781, KM 853, KM 954, KM 6077, KM 46789, KM 929, KM 652, KM 955, KM 652, KM 955, KM 911, EN-46788, 1 860 905 000

Nota: Para códigos de motor, consultar website
Nota: Para códigos de motor, consultar sitio web

REF		
1525	6,25kg	2x

 Kit sincronização Opel 1.0/1.2
 Kit calado Opel 1.0/1.2



Medidor controlo correia
sincronismo
Medidor controlo correia
sincronismo



REF 1707-01

	1.0/1.2
	Crossland X (17-20), Combo E (18-20), Grandland X (17-20)
	EN-52127-2, EN-52809

Nota: Para códigos de motor, consultar website
Nota: Para códigos de motor, consultar sitio web

REF		
1707	1.0/1.2 GDI	740gr
		5x

 Kit sincronização Opel 1.3 diesel

 Kit calado Opel 1.3 diesel

 Ferr. retenção cambota
 Herr. retención cigueñal

REF 1657F

 Chave retenção
 Llave sujeción

REF 1657A

 Acessórios fixação
 Accesorios fijación

REF 1657S

 Alavanca tensão
 Palanca tensor

REF 1657B

	1.3
	Z13DT, Z13DTH, Z13DTJ
	Agila (03-08), Corsa C (03-07), Combo C (03-09), Corsa D (06-09), Astra H (04-09), Tigra B (04-09), Meriva
	KM-662-C, KM 955, EN 46781

REF

1657



1,8kg



5x

 Jogo 2 peças bloqueio dupla árvore de cames Opel 1.8/2.0/2.2

 Juego 2 piezas bloqueio doble arbol de levas Opel 1.8/2.0/2.2

Nota: Para códigos de motor, consultar website

Nota: Para códigos de motor, consultar sitio web

	1.8/2.0/2.2
	A: Astra-G (98-03), Astra H (04-09), Frontera-A (92-98), Vauxhall Frontera-B (99-04), Omega-B (94-03), Sintra (96-99), Speedster (03-), Vectra-B ('95-'02), Zafira (99-04) Zafira B (05-10) B: Astra-G (98-), Astra H (04-), Combo (01-), Corsa-B (94-), Corsa-C (00-), Meriva (03-), Signum (03-), Tigra (94-), Tigra B (04-), Vectra-B (96-), Vectra-C (02-), Zafira (99-).
	A: KM-853, B: KM-852

REF

5278



100gr



60x

 Kit sincronização Opel 1.3 CDTI

 Kit calado Opel 1.3 CDTI

	1.3 CDTI
	Z13DT, Z13DTH, Z13DTJ, Z13DTH
	Agila (03-08), Corsa C (03-07), Combo C (03-09), Corsa D (06-09), Astra H (04-09), Tigra B (04-09), Meriva (04-09)
	104-A EN 46781, EN-46785

REF

1511



1,2kg



5x

 Kit sincronização Opel 2.2/2.5 DCI

 Kit calado Opel 2.2/2.5 DCI

	2.2/2.5 DCI
	G9U, F9Q, Z22SE, Z22YH
	Astra G 2.2, Movano 2.2 DTI A/B, Vectra B 2.2, Zafira 2.2
	MOT 1538, KM 6203/MOT 1536, KM 6204/MOT 1537, KM 6148, MOT 1537/KM 6204

REF

1542



3,7kg



2x

 Kit sincronização Opel 1.4/1.6/1.8/2.0
 Kit calado Opel 1.4/1.6/1.8/2.0



Nota: Para códigos de motor, consultar website
Nota: Para códigos de motor, consultar sitio web

	1.4/1.6/1.8/2.0
	Opel
OEM	MOT 1489, MOT1490-01, MOT 1054, MOT 1496

REF		
1563	2,4kg	5x

 Kit sincronização Opel 2.0/2.3 DCI
 Kit calado Opel 2.0/2.3 DCI



Nota: Para códigos de motor, consultar website
Nota: Para códigos de motor, consultar sitio web

	2.0/2.3 DCI
	Vivaro A CDTI (06-14), Movano B CDTI (10-16), Vivaro B BI-CDTI (14-16)
OEM	EN-48334/MOT 1770, EN-48330/MOT 1766, KM-6130, EN-48332/MOT 1769, EN-17697EN-48331

REF		
1551	2,3kg	5x

 Kit sincronização Opel 2.0 SOHC
 Kit calado Opel 2.0 SOHC



Nota: Para códigos de motor, consultar website
Nota: Para códigos de motor, consultar sitio web

	2.0 SOHC
	Antara (06-10)
OEM	EN-48245, EN-48246

REF		
1567	1,1kg	10x

 Ferramenta alinhamento carretos árvore cames Opel 1.3
 Herramienta de alineación arbol levas Opel 1.3



Nota: Para códigos de motor, consultar website
Nota: Para códigos de motor, consultar sitio web

	1.3
	Opel Corsa E, 1.3 (2015)
OEM	EN-50509

REF		
1653	440gr	50x

 Kit sincronização Opel 1.0/1.2 VTi
 Kit calado Opel 1.0/1.2 VTi



Nota: Para códigos de motor, consultar website
Nota: Para códigos de motor, consultar sitio web

	1.0/1.2 VTi
	Combo E (2018-), Corsa F (2019-), Crossland X (2017-), Grandland X (2017-)
OEM	0109-2B, EN-52588 0109-2A, EN-52127-1, EN-52127-2

REF		
1646	860gr	5x

 Kit sincronização Opel 1.0/1.2/1.4
 Kit calado Opel 1.0/1.2/1.4



	1.0/1.2/1.4
	LWD, L2Z, LDD, LUU, A14XFL, A14XER, A14XEL, LUJ, A14NEL, A14NET, A10XEP, A12XEL, A12XER, LDDA, LUH, L2Q, LDC
	Adam, Ampera, Astra J, Corsa D, Insignia, Meriva B, Mokka, Zafira C Tourer
	EN-49977-100, KM-953-A, KM-955-2, KM-955-1, EN-49977-200, KM-952, EN-49978

REF

1579



2kg



5x

 Kit sincronização Opel 1.4/1.6/1.8/2.0
 Kit calado Opel 1.4/1.6/1.8/2.0



	1.4/1.6/1.8/2.0
	F4R(t) 2.0 16v - 720, 722, 820
	Vivaro (01-11)
	1054, 1489, 1496

REF

1587



1,8kg



5x

 Kit sincronização Opel 2.5D/2.8D
 Kit calado diesel Opel 2.5D/2.8D



	2.5D/2.8D
	Arena (97-01), Movano-A (98-03)
	OEM3 KM6031

REF

1706



140gr



96x

 Kit sincronização Opel 1.6 dCi/1.6D/1.7D
 Kit calado Opel 1.6 1.6 dCi/1.6D/1.7D



	1.6 dCi/1.6D/1.7D
	1.6D: 622.951, 626.951, R9M, R9M-402, R9M-404, R9M-408, R9M-409, R9M-450, R9M-452, R9M-410, R9M-413, LWX, LWZ, LWU, LWY 1.7D: R9N/ R9N 4/ R9N 401
	Vivaro B
	MOT1969, MOT1970, MOT1770, MOT1773, EN-48330, EN-48332, EN-48334, EN-48831, KM-6130

REF

1620



2,4kg



5x

 Kit sincronização Opel 1.6 CDTI
 Kit calado Opel 1.6 CDTI



	1.6 CDTI
	VL/B16DTH, LVM/B16DTL, LVL/B16DTN, LVM/B16DTC, LWQ/B16DTE, LVL/B16, LVL/B16DTJ
	Meriva-B, Mokka, Zafira-C Tourer (13-16)
	EN-51413-2, EN-955-2, EN-51412, EN-51414, EN-51411

REF
1622

1,4kg

10x

 Kit sincronização Opel 2.0 CDTI
 Kit calado Opel 2.0 CDTI



	2.0 CDTI
	Cascada (15-17); Insignia (14-17); Insignia Country Tourer (14-17), Zafira C Tourer (14-17)
	EN-51413-2, EN-955-2, EN-51412, EN-51414, EN-51411

REF
1623

1,8kg

5x

 Kit sincronização Opel 2.0 CDTI
 Kit calado Opel 2.0 CDTI



	2.0 CDTI
	LFS/B20DTH
	Cascada (15-17), Insignia (14-17), Insignia Country Tourer (14-17), Zafira C Tourer (14-17)
	EN-51415, EN-51418

REF
1632

1,4kg

5x

 Kit sincronização Opel 1.4 1.6 1.8 gasolina
 Kit calado Opel 1.4 1.6 1.8 gasolina



	1.4/1.6/1.8
	Astra-G (03-10), Astra-H (04-13), Astra-J (09-13), Corsa-D (07-13), Insignia (08-13), Meriva-A (06-10), Signum (06-08), Vectra-C (06-08), Zafira-B (05-13), Zafira-C Tourer (11-15)
	KM-6628-A, KM-6340, KM-6333, KM-6625, KM-6349/KM-6130, KM-911

REF
1645

1,1kg

5x

 Kit sincronização Opel 1.3 CDTI
 Kit calado Opel 1.3 CDTI



	1.3 CDTI
	LKU B13DTE, LKU B13DTR, LKV B13DTC
	Corsa E 1.3
	KM-662-C, EN-50515, EN-51500, EN-46775, KM-955-1, EN-46785

REF

1667



2,7kg



5x

 Ferramenta bloqueio polia cambota 1.0/1.2 Gasolina Opel
 Herramienta bloqueo polea cigüeñal 1.0/1.2 Gasolina Opel



	EBO 1.0 e EB2 1.2 3 cilindros de correa molhada EBO 1.0 y EB2 1.2 de 3 cilindros con correa húmeda
	Opel

REF

1701



784gr



20x

 Chave para correia da polia cambota VW 1.6
 Llave para correa polea cigüeñal VW 1.6



	1.6
	ARC, AVY
	VW: Lupo, Polo, New Beetle, Golf, Bora, Caddy, Seat: Ibiza, Cordoba
	T10028 Seat, T10028 Škoda, T10028 VW

REF

1700



2kg



4x

 Kit sincronização VW 1.2 6V/12V
 Kit calado VW 1.2 6V/12V



	1.2 6V/1.2 12V
	1.2 6V: AWY, BBM, BMD, CHFA, CHFB 1.2 12V: AZQ, BME, BXV, BZG, CEVA, CGPA, CGPB, CGPC
	VW: Fox (05-12), Polo MkIV (02-09), Polo MkIV (10-14) Seat: Cordoba (02-08), Ibiza MkIV (02-09), Ibiza MkIV (08-15), Toledo (12-15) Škoda: Fabia (02-07), Fabia II (07-15), Praktik (07-15), Rapid (12-15), Roomster (06-15)
	T10123, T10121, T10120

REF

1515



980gr



10x

 Kit sincronização VW 1.2 TSI/TFSI
 Kit calado VW 1.2 TSI/TFSI



	1.2 TSI/TFSI
	CBZA, CBZB, CBZC
	VW: Beetle (11-16), Caddy/Caddy Max (10-16), Golf Plus (10-14), Golf VI (09-13), Golf VI Cabrio (11-16), Golf VI Estate (10-13), Jetta (11-17), Polo (09-14), Touran (10-16) Seat: (10-13) TSI, Ibiza (10-16) TSI Ecomotive, Ibiza (10-16) TSI Ecomotive, Ibiza (10-16) TSI FR, Leon (10-13) BI-Fuel, Toledo (12-16) Škoda: Fabia II (10-16), Octavia II (10-13), Praktik (10-15), Rapid (12-16), Rapid Spaceback (13-16), Roomster (10-16), Yeti (11-16) Audi: A1/A1 Sportback (10-16) TFSI, A3 Cabrio (10-13) BlueMotion, A3/A3 Sportback
	T10340, T10414, T10341

REF		
1529	680gr	10x

 Kit sincronização VW gasolina 1.0 TSI/FSI, MPI, 1.2/1.4 TSI
 Kit calado VW gasolina 1.0 TSI/FSI, MPI, 1.2/1.4 TSI



	1.0 TSI/FSI, MPI, 1.2/1.4 TSI
	1.0 MPI: CHYA 1.0 TSI: CHZE, CHZC, CHZA, CHZB, CHZC, CHZD, CHZJ 1.2 TSI: CJZB, CJZC, CYVA, CJZA, CJZD, CYVB 1.4 TSI: CZCC, CMBA, CZCA, CHPA, CPTA (ACT), CZDA, CVNA, CZEA (ACT)
	VW: UP Seat: Mii Škoda: Citig
	T10340, T10477, T10476, T10499, T10494, T10487

REF		
1625	3,2gr	2x

 Kit de sincronização grupo VAG TSI 1.2/1.4
 Kit calado grupo VAG TSI 1.2/1.4



	1.2/1.4FSI
	1.2 TSi: CJZA, CJZB 1.4 TSi: CGGA, CHPA, CMBA, CPVA, CRJA, CXSA 1.4 TSi ACT: CPTA
	VW: Golf VII (08-15), Golf VII Estate (08-15), Jetta (12-14), Polo (12-14) Seat: Ibiza (12-15), Leon (12-15), Toledo (12-15) Škoda: Octavia II (10-13), Octavia III (10-15) Audi: A1 (12-15), A1 Sportback (12-15), A3 (13-15), A3 Sportback (12-15)
	T10550/1, T10550/2, T10550/3, T10550/3

REF		
1664	2,2kg	10x

 Kit bloqueio árvore de cames VW 1.4 TSI
 Kit bloqueio árbol de levas VW 1.4 TSI



	1.4 TSI
	CZEA
	VW: Golf VII, Passat, Polo, Tiguan Seat: Ateca, Ibiza V, Leon, Leon ST, Leon SC Škoda: Superb III Audi: A1, A3, Q3
	T10504, T10504/1, T10504/2

REF

1640



1,5kg



10x

 Kit sincronização grupo VAG 2.5 TDI
 Kit calado grupo VAG 2.5 TDI



	2.5 TDI
	AFB, AKE, AKN, AYM, BAU, BCZ, BDG, BDH, BFC
	VW: Passat, Sharan Audi: A4, A6, A8, S4 Turbo, S6 V8
	T10504, T10504/1, T10504/2

REF

1502



1,6kg



5x

 Kit sincronização grupo VAG completo 1.9/2.0/1.9 TDI/2.5 V6 TDI/3.3 V8 TDI/1.4/1.6
 Kit calado grupo VAG completo 1.9/2.0/1.9 TDI/2.5 V6 TDI/3.3 V8 TDI/1.4/1.6



Nota: Para códigos de motor, consultar manual
Nota: Para códigos de motor, consultar el manual

	1.9/2.0/1.9 TDI/2.5 V6 TDI/3.3 V8 TDI/1.4/1.6
	VAG VW, Seat, Škoda, Audi
	T10120, T101123, T10016 , T10074, T10121, U20003/2064, T20102/3359, 3242, T10050/310-085/23-059, T10100, T10020/V.159, T20038, MP1-312, 3418, T10098, MP 1-312, 3458, 3369, 3366, 10008, T20046, U40021/2065A, T10060/A, T10265, T10264

REF

1514



4,25kg



2x

 Ferramenta bloqueio motor grupo VAG 1.4/1.6 FSI
 Herramienta bloqueo motor grupo VAG 1.4/1.6 FSI



	1.4/1.6 FSI 16V
	VW: Bora (00-05), Caddy (00-06), Golf (97-06), Golf (00-06), Lupo (98-05), Beetle (01-10), Polo (98-01), Polo (99-08) Seat: Altea (05), Arosa (00-04), Cordoba (99-09), Ibiza (02-09), Inca (00-03), Leon (09-06), Toledo (99-06) Škoda: Fabia (99-14), Octavia (00-13), Roomster (06-post)
	T10016/T10074

REF

1524



400gr



2x

 Kit sincronização grupo VAG 2.7/3.0 TDI
 Kit calado grupo VAG 2.7/3.0 TDI



	2.7/3.0 TDI
	ASB, BKN, BKS, BMK, BMZ, BNG, BPP, BSG, BUG, BUN, CAMA, CAMB, CANA, CANB, CANC, CAND, CAPA, CARA, CARB, CASA, CASB, CASC, CATA, CCMA, CCWA, CCWB, CDYA, CDYB, CDYC, CEXA, CGKA, CGKB
	VW: Touareg, Phaeton Audi: A4, A5, A6, A8, Q5, Q7
	T40061, T40062, T40049, T40060, T40058, 3359, 3242

REF		
1517	2kg	5x

 Kit de sincronização grupo VAG 1.6/2.0 TDI
 Kit calado grupo VAG 1.6/2.0 TDI



	2.6/2.0 TDI
	CAYB, CAYC, CBAB, CBBB, CBAA, CFFB, CAGA, CAHA, CAGH, CAHB, CAGC, FCA, CAAA, CAAB, CAAC, CCHA, CAVA, CBDA, CBDD, CBAC, CBDC
	VW: Golf 1.6 (2009), Golf Plus 1.6, Tiguan 2.0 (2009), Passat 2.0, Eos 2.0, Golf 2.0, Golf Plus 2.0 Seat: Exeo 2.0 (2009) Audi: A3 1.6 (2009), A3 2.0 (2007), A4 2.0, A6 2.0, Q5 2.0
	T20 102 3359, T10050, T10100, T10264, T10265, T40098, T10051, T10052, T10255

REF		
1531	2kg	5x

 Kit de sincronização grupo VAG 1.4/1.6 TFSI/FSI
 Kit calado grupo VAG 1.4/1.6 TFSI/FSI



Nota: Para códigos OEM, consultar website
Nota: Para códigos OEM, consultar sitio web

	1.4/1.6 FSI / TSI
	AXU, BLG, BAG, BMY, BKG, BMK, BLF, CAVA, BLN, CAVB, BLP, CAVC, CAVE, CAVF, CAVD, CAXA, CAXC, CDGA, BTS
	VW: Golf (03-09), Golf Plus (05-09), Jetta (06-09), Passat (05-09), Polo (02-08), Scirocco (09-10), Tiguan (07-09), Touran (03-09), Eos (06-09) Seat: Ibiza, Leon, Altea Škoda: Octavia (04-09), Fabia (07-09), Superb (09-10), Roomster (06-09) Audi: A3 (03-10)

REF		
1544	1,6kg	5x

 Ferramenta alinhamento e ajuste árvore de cames VAG 1.8/2.0
 Herramienta alineamiento y ajuste árbol de levas VAG 1.8/2.0



	1.8/2.0 TSI
	VW: Jetta MK5, Passat(B6), Passat CC, Jetta MK6, Scirocco, Golf GTI MK6 Seat: Leon(1P), Altea XL, Altea Freetrack, Leon FR, Exeo Škoda: Yeti, Octavia(1Z), Superb(3T), Octavia Audi: TT(8J), A3(8P), A4(B7), A4(B8) A5, A3 Cabriolet, TT, A4(B8), A5, Q3, Q5

REF		
1631	675gr	20x

-  Ferramenta bloqueio árvore de cames VAG 1.2/1.4 TFSI
 Herramienta bloqueo árbol de levas VAG 1.2/1.4 TFSI



	1.2/1.4 TFSI
	VW: Golf (2013) Seat: Leon (2013) Škoda: Octavia (2013) Audi: A3 (2013)
	T10340, T10949

REF		
1647	360gr	50x

-  Kit sincronização grupo VAG 2.0 FSI/TFSI
 Kit calado grupo VAG 2.0 FSI/TFSI



	2.0 FSI/TFSI
	2.0 FSI - AXW, BLR, BLX, BLY, BVX, BVY, BVZ, 2.0 TFSI - AXX, BPY, BWA 2.0 GTI - AXX, BPY, BWA, BYD
	VW: Eos, Golf Plus, Golf V / VI / VI Cabrio, Jetta, Passat, Polo, Scirocco, Touran Seat: Altea / Altea XL, Leon, Toledo, Exeo Škoda: Octavia Audi: A3 / A3 Sportback, A4, A6, S3, TT
	T10020, T10252, T40011, T10115, 3366, T10060/A, T1009

REF		
1558	2kg	5x

-  Kit sincronização grupo VAG 1.4/1.6/2.0 TDI CR
 Kit calado grupo VAG 1.4/1.6/2.0 TDI CR



	1.4 TDI CR/1.6 TDI CR/1.6 TDI CR/1.6 TDI CR BlueMotion/1.6 TDI CR Ecomotive, 2.0 TDI CR, 2.0 RS TDI CR, 2.0 TDI CR ultra
	CKFB, CKFC, CLHA, CNHA, CNHC, CRBC, CRBD, CRFA, CRFC, CRKA, CRKB, CRLB, CRLC, CRMB, CRVA, CRVC, CSUA, CSUB, CUNA, CUPA, CUTA
	VW: Golf SV / Sportsvan, Golf VII / Golf VII Estate, Golf VII Wagon, Polo Seat: Leon / Leon ST Škoda: Octavia III Audi: A3 Cabrio, A3 Saloon, A3 Sedan, A3 Sportback, A4/A4 Allroad, A4 quattro, A5 Coupe/Cabriolet, A5 Sportback, A6, Q5, TT
	T10490, T10051, T10060A, T10264

REF		
1541	1,8kg	5x

-  Chave tensionar correia distribuição grupo VAG 1.2/1.4/1.9TDI
 Llave tensionar correia distribución grupo VAG 1.2/1.4/1.9TDI



	1.2/1.4/1.9TDI
	VW: Lupo 3L 1.2 TDI, Lupo/Polo 1.4TDI, Golf/Bora/Beetle/Sharan 1.9 TDI, Passat 1.9TDI. Seat: Alhambra 2.0
	3387 / T10004

REF		
1575	225gr	40x

 Bloqueio correia de transmissão grupo VAG 1.2/1.4 TSI
 Bloqueo correa transmisión grupo VAG 1.2/1.4 TSI



	1.2/1.4 TSI
	CJZA, CJZB, CGGA, CHPA, CMBA, CPVA, CRJA, CXSA, CPTA
	Seat: Ibiza, Leon, Toledo Škoda: Fabia, Octavia II, Octavia III Audi: A1 / A1 Sportback, A3 / A3 Sportback
	T10499, T10504, T10340, T10494, T10060A

REF		
1571	3,6kg	2x

 Jogo regulação VAG 1.3D/1.4D/1.5/1.6/1.7SDI/1.9T/TD/1.9TDI/1.9SDI/TDI/1.9D/TD/1.9SDI/2.4D/TD/2.5TDI/2.5TDI/SDI
 Juego ajuste VAG 1.3D/1.4D/1.5/1.6/1.7SDI/1.9T/TD/1.9TDI/1.9SDI/TDI/1.9D/TD/1.9SDI/2.4D/TD/2.5TDI/2.5TDI/SDI



	1.3D/1.4D/1.5/1.6/1.7SDI/1.9T/TD/1.9TDI/1.9SDI/TDI/1.9D/TD/1.9SDI/2.4D/TD/2.5TDI/2.5TDI/SDI
	VW: Lupo, Polo, Polo Classic, Golf, Caddy, Jetta, Golf Vento, Transporter, Passat, Passat Sharan Seat: Ibiza, Córdoba, Toledo, Inca Škoda: Felicia, Cube Audi: 80, 100, A4, A6
	2065A, 2064

REF		
1568	200gr	20x

 Chave tensor correia ajustável grupo VAG
 Llave tensor correa ajustable grupo VAG



	VW, Audi
---	----------

REF		
1577	260gr	50x

 Kit sincronização grupo VAG 1.8/2.0
 Kit calado grupo VAG 1.8/2.0



	1.8/2.0 TSI/TFSI
	CDHB, CDNC, CFKA, CDHB, CDNB, CDNC, CDHB, CDNC, CDNB
	Audi: A4 (quattro), A5 (Coupé/Cabriolet), A5 (Sportback)
	T40265, T40271, T40267, T10368, T40011, T10352/1, T10352/2, T10352, T40196, T40267, T10060A

REF		
1610	1,74kg	5x

 Kit sincronização grupo VAG 1.8/2.0 TSI/TFSI
 Kit calado grupo VAG 1.8/2.0 TSI/TFSI



	1.8/2.0 TSI/TFSI
	BYT, BZB, CABA, CABB, CABD, CAWB, CBFA, CCTA, CCZA, CCZB, CCZC, CDHA, CDHB, CDNB, CDNC, CDND, CFKA, CGYA, CCZA, CCZB, CCZC, CCZD, CDAA, CDAB
	VW: Passat (2006), Passat CC (2009) Audi: A4 (2008), A5 Cabriolet (2009), A5 Coupe (2008), Q5 (2008), A3 (2012), A3 (1.8,2.0 TFSi/TSi) (07-13), A4 (1.8,2.0 TFSi/TSi) (07-13), A5 (1.8,2.0 TFSi/TSi) (07-13), Q5 (1.8,2.0 TFSi/TSi) (07-13), TT (1.8,2.0 TFSi/TSi) (08-13)
	T10352, T10352/2, T10352/1

REF



1611

300gr

10x

 Kit sincronização grupo VAG 1.8/2.0 TSI/TFSI
 Kit calado grupo VAG 1.8/2.0 TSI/TFSI



	1.8/2.0 TSI/TFSI
	CDHB, CNDC, CFKA, CDNB, CCZC, CPSPA, CDAA, CCZA, CESA, CETA, CJEB
	Audi: A4 Quattro (08), A4 Quattro (08), A4 Quattro (09), A5 Coupé/Cabriolet (09), A5 Coupé/Cabriolet (08), A5 Sportback (09), A5 Sportback (09), A6 (09), Q3 (11), Q3 (11), Q5 (09), TT (08), TT (08), TT (10), TT (10), A4 (12), A4 Quattro (12), A5 Coupé/Cabriolet (11), A5 Sportback (11).
	T40271-2, T40267, T10170, T40265, T40271-1, VAS6079, T10352, T40011.

REF



1602

1,6kg

5x

 Kit sincronização grupo VAG 1.2/1.4 TFSI
 Kit calado grupo VAG 1.2/1.4 TFSI



	1.2/1.4 TFSI
	1.2 TFSI: CJZA, CJZB, CJZC, CJZD 1.4 TFSI: CGGA, CGGB, CHPA, CMBA, CPVA, CPVB, CRJA, CXSA 1.4 TFSi ACT: CPTA
	VW: Golf VII (08-15), Golf VII Estate (08-17), Jetta (12-17), Polo (12-17), Sportsvan (14-17). Seat: Ibiza (12-17), Leon (12-15), Toledo (12-17) Škoda: Fabia II (10-15), Fabia III (14-17), Octavia II (10-13), Octavia III (10-15), Praktik (10-15), Roomster (10-15), Rapid (15-17) Audi: A1 (12-15), A1 Sportback (12-15), A3 (13-15), A3 Sportback (12-15)
	T10550

REF



1626

2,5kg

5x

 Chave tensor correia árvore cames VAG 1.0/1.2/1.4
 Llave del tensor árbol de levas VAG 1.0/1.2/1.4



	1.0/1.2/1.4
	VW: Up!, Golf VII Seat: Mii, León Škoda: Octavia, Citigo Audi: A1, A3
	T10499

REF		
1699	120gr	50x

 Kit bloqueio polia árvore de cames grupo VAG
 Kit bloqueio polea arbol de levas grupo VAG



	1.2/1.4/1.6/2.0 TDI
	VW: Beetle, Golf VII, Passat (B8), Polo V, Polo VI, Sharan II, Tiguan I, Tiguan II, Touran II, T-Roc, Up! Seat: Alhambra II, Arona, Ateca, Ibiza (Typ 6J/6P), Ibiza (6F), Leon III, Toledo IV Škoda: Citigo, Fabia III, Karoq, Kodiaq, Mii, Octavia III, Rapid, Superb III, Yeti Audi: A1, A3 (8V), A4 (B9), A5 (F5), Q2, Q3 (8U)
	T10172-A, T10554

REF		
1671	3,8kg	2x

 Kit sincronização VAG 1.2/1.4/1.6 FSi TSi TFSI
 Kit calado VAG 1.2/1.4/1.6 FSi TSi TFSI



	1.2 TFSI/1.4 FSi/TFSI/1.6 FSi
	1.2 TFSi: CBZA, CBZB, CBZC 1.4 FSi/TFSi: BLG, BMY, BWK, CAVA, CAVB, CAVC, CAVD, CAVE, CAVF, CAXA, CAXC, CDGA, CSMA 1.6 FSi: BAG, BLF, BLP
	VW: Beetle (11-15), Caddy/Caddy Maxi (10-15), EOS (07-15), Golf V (03-13), Golf V Estate (07-09), Golf VI (10-13), Golf VI Estate (10-13), Golf VI Cabriolet (11-15), Golf Plus (05-14), Jetta (05-14), Passat (05-15), Polo (09-14), Scirocco (08-14), Tiguan (07-15), Touran (03-15) Seat: Altea/Altea XL (10-15), Ibiza (10-15), Leon (10-13), Toledo (12-15) Škoda: Fabia II (10-15), Praktik (10-15), Rapid (12-15), Rapid Sportback (12-15), Octavia II (04-13), Yeti (09-15), Yeti Outdoor (13-15) Audi: A1 (10-15), A1 Sportback (10-15), A3 Cabriolet (10-13), A3 (10-15), A3 Sportback (03-13)
	T10171/T10171A, T10170, VAS6079, T10341, T40011, T10340

REF		
1697	2kg	5x

 Ferramenta de alinhamento e montagem árvore de cames grupo VAG 1.2,1.6,2.0,2.7,3.0,4.0,4.2 TDI CR

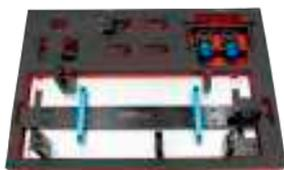
 Herramienta alineamiento y montaje árbol de levas grupo VAG 1.2,1.6,2.0,2.7,3.0,4.0,4.2 TDI CR

	TDI CR 1.2/1.6/2.0/2.7/3.0/4.0/4.2
	ASB, ASE, BKN, BKS, BMK, BNG, BPP, BSG, BTR, BUG, BUN, BVN, CAAA, CAAB, CAAC, CAAD, CAAE, CAGA, CAGB, CAGC, CAHA, CAHB, CAMA, CAMB, CANA, CANB, CANC, CAND, CAPA, CARA, CASA, CASB, CASC, CASD, CATA, CAYA, CAYB, CAYC, CAYD, CAYE, CBAA, CBAB, CBAC, CBBA, CBBB, CBDA, CBDB, CBDC, CCFA, CCFC, CCHA, CCHB, CCLA, CCMA, CCWA, CCWB, CDBA, CDCA, CDSB, CDTA, CDTB, CDUC, CDUD, CDYA, CDYB, CDYC, CEGA, CEXA, CFCA, CFFA, CFFB, CFFD, CFFE, CFGB, CFGC, CFGD, CFHA, CFHB, CFHC, CFHD, CFHE, CFHF, CFJA, CGKA, CGKB, CGLA, CGLB, CGLC, CGLD, CGLE, CGQB, CJAA, CJCA, CJCB, CJCC, CJCD, CJGA, CJGC, CJGD, CJMA, CKDA, CKTB, CKTC, CKUB, CKUC, CKVB, CKVC, CLAA, CLAB, CLCA, CLCB, CLJA, CLLA, CLNA, CLZB, CMEA, CMFA, CMFB, CMGB, CMHA, CNEA, CNFA, CNRB, CRCA, CSHA, M05/9D (CAS), M05/9E, M05/9E (CRCA), M05/9E (CRCB)
	VW, Seat, Škoda, Audi, Porche (2013-2015)
	T40094, T40095, T40096, T40096/1, T40094/1, T40094/2, T40094/9, T40094/10, T40094/11

REF



1582

9,5kg

1x

 Kit bloqueio polia árvore de cames grupo VAG 2.4/2.5/2.8/3.0T/3.2

 Kit bloqueo polea árbol de levas grupo VAG 2.4/2.5/2.8/3.0T/3.2

	2.4/2.5/2.8/3.0T/3.2
	AUK, BDW, CCAA, CALB, CALA
	VW: Jetta (05-) Audi: A4, A6, A8, RS4, S5, A5, Allroad, S8, R8, Q7 (05-), Q5
	T40058, T40071

REF



1672

5,75kg

2x

 Bloqueio roda dentada grupo VAG 1.8/2.0 TFSI

 Bloqueo rueda dentada grupo VAG 1.8/2.0 TFSI

	1.8/2.0 TFSI
	CABD, CAEA, CDNB, CDNA, CAWA, CBFA, CCTA, CCZA, CAEB, CDNC, CDHA, CABA, BYT, BZB, CDAA, CABB, CDHB.
	VAG

REF



1673

500gr

20x

 Bloqueio roda dentada grupo VAG 1.9 TDI
 Bloqueo engranaje grupo VAG 1.9 TDI



	1.9 TDI
	VW, Škoda

REF		
3320	170gr	10x

 Extrator eixo de equilíbrio grupo VAG 1.8/2.0
 Extractor eje de equilibrio grupo VAG 1.8/2.0



	1.8/2.0
	VW (2007 - 2017) Seat (2006 - 2017) Škoda (2007 - 2017) Audi (2007 - 2017)
	T10394

REF		
6420	1,7kg	10x

 Chave de caixa 1/2" ponta ribe R9 grupo VAG
 Llave de vaso 1/2" punta ribe R9 grupo VAG



	VAG
---	-----

REF			
2101	140mm	140gr	250x

 Bloqueio carreto do motor grupo VAG 1.4/1.9/2.0TDI PD/2.0ST
 Bloqueo piñón cigüeñal grupo VAG 1.4/1.9/2.0TDI PD/2.0ST



	1.4/1.6 FSI / TSI
	VW: Tiguan, Passat, Eos, Golf, Golf Plus (08) Seat: Exeo 2.0 (09) Audi: A3, A4, A6, Q5 (07)

REF		
3317	120gr	40x

-  Bloqueo carrito cambota 1.4/1.9/2.0 Tdi PD
 Bloqueo piñón cigüeñal 1.4/1.9/2.0 Tdi PD



	1.4/1.9/2.0 Tdi PD
	VW: Caddy, Eos, Golf, Jetta, Passat, Polo, Sharan, Tiguan, Touran, Transporter Seat: Toledo

REF		
3319	190gr	10x

-  Bloqueo carrito cambota grupo VAG 1.9 TDI/SDI
 Bloqueo piñón cigüeñal grupo VAG 1.9 TDI/SDI



	1.9 TDI/SDI
	VW: Passat 1.9 Seat: Alhambra, Altea, Arosa, Cordoba, Ibiza, Leon, Toledo Audi: A4 1.9, A6 1.9
	T10008/310-084/23-058, 3359/T20102, T10050/310-085

REF		
3318	120gr	40x

-  Bloqueo carrito do motor grupo VAG 1.2D, 1.4D, 1.6D, 1.9D, 2.0D TDi PD/CR
 Juego de herramientas de reglaje VAG 1.8/2.0 TFSI 1.2D, 1.4D, 1.6D, 1.9D, 2.0D TDi PD/CR

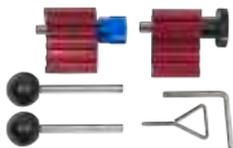

	1.2D, 1.4D, 1.6D, 1.9D, 2.0D TDi PD/CR
	BLB, BNA, BRE, BRF, BVG, AZV, BKD, BKP
	VW: Amarok (10-12), Beetle (02-11), Bora (02-08), Caddy/Maxi (03-12), Eos (06-10), Fox (05-11), Golf (02-12), Golf Plus (05-12), Jetta (05-11), Lupo (02-05), Passat/CC (02-12), Polo (99-12), Scirocco (08-12), Sharan (02-10), Tiguan (07-12), Touran (03-12), Transporter (03-12) Seat: Alhambra (00-10), Altea/Altea XL (04-12), Cordoba (02-09), Ibiza (02-10), Leon (00-12), Toledo (04-11) Škoda: Fabia (00-07), Fabia II (07-12), Octavia (00-10), Octavia II (04-12), Roomster (07-12), Superb (02-08), Superb II (08-12), Yeti (09-12) Audi: A1 (10-12), A3 (01-12), A4/Allroad (01-12), A5 (08-12), A6 Allroad (98-11), Q5 (08-12), TT (08-10)
	T10060/A, T10100, T10050, 310-085, T10115, 3359, T20102

REF		
3321	250gr	40x

 Kit sincronização VW 1.9 TDI
 Kit calado VW 1.9 TDI



	1.9 TDI/SDI
	-AGR, AHF, ALH, AGP, AQM
	VW: Beetle, Bora, Caddy, Golf IV, Golf IV, Estate, Polo, Polo Classic, Polo Estate
	T20038, MP1-312, 3418, T10098, MP 1-312

REF		
1564	800gr	50x

 Kit sincronização VW Transporte T5 Touareg 2.5/4.9D/TDI PD
 Kit calado VW Transporte T5 Touareg 2.5/4.9D/TDI PD



	2.5/4.9D/TDI PD
	BAC, BLK, BPD, AXD, AXE, BLJ, BNZ, BPC, AYH
	VW: Touareg, Transporter
	T10199, T10234, T10226, T101199/1, T10193, T10194, T10225

REF		
1552	8,75kg	2x

 Alavanca tensão instalação correia distribuição VW
 Palanca tensión correia distribución VW



	ASN, BBJ
	VW: Golf, Passat, Polo, T4

REF		
2898	666gr	24x

 Kit sincronização VAG 4.2
 Kit calado VAG 4.2



	4.2 V8
	Audi: A6L, A8L
	T40046, T40047

REF		
1641	1,35kg	10x

 Kit correia transmissão bomba combustível 2.7/3.0 TDI
 Kit correa transmisión bomba combustible 2.7/3.0 TDI



	2.7/3.0 TDI
	2.7 - CAMA, CAMB, CANA, CGKA, CGKB, CANC, CAND, CANB 3 - CWA, CASA, CASB, CDYC, CDYA, CCWB, CCMA, CCLA, CDYB, M05/9D (CAS), M05/9E, CAS, CARA, CEXA, CATA, CASC, CASD, CEXB
	VW: Phaeton (07-15) Audi: Q5 (08-12), Q5 Coupé (07-12), A4 (07-12), Q7 (07-15), A6 Quattro (08-11) Porsche: Cayenne (08-16)
	T40135, T40237, T10320, T40058

REF

1650



1,22kg



2x

 Jogo sincronização VAG 2.5/2.8/3.2 FSI 3.2 TFSI
 Kit calado VAG 2.5/2.8/3.2 FSI 3.2 TFSI



	2.5L FSI/2.8L FSI/3.2L FSI/3.0L TFSI
	VW: Touareg 3.0 TFSI (12-17) Audi: A4 (14- 15), A5 (14-17), A6 (12-18), A7 (10-18), A8 (10-18), S4 (14-17), S5 (11 - 17), Q5 (08-17), Q7 (10-18), SQ5 (13-17) Porsche: Cayenne S Hybrid (10-14), Panamera (11-13)
	T40133/1/2, T40058, T40069, T40071

REF

1712



1,34kg



10x

 Kit sincronização VAG 1.0/1.2/1.4/1.5/1.6 TSi
 Kit calado VAG 1.0/1.2/1.4/1.5/1.6 TSi



	1.0/1.2/1.4/1.5/1.6 TSi
	EA 211, EVO 4-cili. TSi ACT, EA 211 3, 4 cili
	VW: (2015-), Seat: (2015-), Škoda: (2015-) Audi: (2017-)

REF

1730



4kg



2x

 Kit sincronização VAG 1.5 TSi
 Kit calado VAG 1.5 TSi



	1.5 TSi
	DACA, DACB, DADA, DFYA, DPBA, DPBE, DPCA
	VW, Seat, Škoda, Audi
	VAS 611 007, T10504/1, T10340, T10499

REF

1731



2,8kg



2x

 Jogo adaptadores sincronização motor VAG 1.0/1.2/1.4 TSi
 Kit de adaptadores de puesta a punto del motor VAG 1.0/1.2/1.4 TSi



	1.0/1.2/1.4 TSi
	1.0L CHZA, CHZB, CHZC, CHZD, CHZF, CHZJ, CHZK, CHZL, CPGA, DBYA, DKJA, DKLA, DKLB, DKLC, DKLD, DKRA, DKRB, DKRC, DKRF, 1.2L CJZA, CJZB, CJZC, CJZD, CYVA, CYVB, CYVD, 1.4L CHPA, CMBA, CPVA, CPVB, CPWA, CUKB, CUKC, CXSA, CZCA, CZDA, CZDD, DGEA, DGEB
	VW, Seat, Škoda, Audi

REF		
1732	1,9kg	10x

 Kit sincronização ajuste árvore cames Audi 2.5 TFSi
 Kit bloqueo árbol cames Audi 2.5 TFSi



	2.5L TFSi
	DAZA, DNWA
	Audi: RS3 (16-21), RS Q3 (19-), TT(16-18), TT (19-)
	T03003, T40264/2A, T40069, T40011, T03006 T40297

REF		
1723	2,1kg	5x

 Kit sincronização Porsche Cayenne / Panamera V8
 Kit calado Porsche Cayenne / Panamera V8



	V8
	Panamera, Cayenne (08-), Cayenne (08)
	9678/1, 9683/1, 9595/1, 9678, 9714

REF		
1689	5,5kg	2x

 Kit sincronização Porsche Boxster e Carrera 2.5/2.7/3.2/3.4/3.6
 Kit calado Porsche Boxster y Carrera 2.5/2.7/3.2/3.4/3.6



	2.5/2.7/3.2/3.4/3.6
	911 Carrera 4S 3.6 (02), 996 3.4 (02), Boxster 2.5 (98), Boxster 2.7 (00) Boxster 3.2 (00). Chassis: 986/7, 996/7
	9602, 9608, 9611, 9612, 9634. 9595

REF		
1500	12kg	2x

-  Kit sincronização Porsche Cayenne árvore cames 996/997
 Kit calado Porsche Cayenne arbol de levas 996/997



	996/997
	Cayene (2005)
	9685, 9686, 9595/1

REF		
1603	1,08kg	10x

-  Kit sincronização Porsche 3.0/3.6 turbo
 Kit calado Porsche 3.0/3.6 turbo



	3.0/3.6
	MCT.M, MCT.L
	Macan 3.0S, 3.6 Turbo
	9861

-  **Info:** Jogo complementar ao artigo REF 1689
 **Info:** Conjunto complementario del artículo REF 1689

REF		
1690	1,2kg	10x

-  Kit sincronização Porsche motor MA1
 Kit calado Porsche motor MA1



	MA1
	MA1/02, MA1/01, MA1/70, MA1/03, MA1/04, MA1/75, MA1/76, MA1/71, MA1/01S, MA1/20, MA1/21, MA1/21C, MA1/22, MA1/3, MA1/23, MA1/20C, MA1/22C, MA1/23C
	911, Boxster, Cayman
	9772, 9773, 9595/1, 9775

REF		
1728	5,85kg	2x

-  Kit sincronização Chevrolet 2.0 SOHC
 Kit calado Chevrolet 2.0 SOHC



	2.0 SOHC
	LLWZ20DMH, RA420, Z20SI, Z20S3, Z20S4, Z20S5
	Captiva, Cruze, Epica, Lacetti
	EN-48245, EN-48246

REF		
1567	1,1kg	10x

 Kit sincronização Chevrolet, SAAB 1.4/1.6/1.8 Gasolina
 Kit calado Chevrolet, SAAB 1.4/1.6/1.8 Gasolina



	1.4/1.6/1.8
	Chervrolet: Aveo (08-13), Cruze (09-12), Orlando (11-15) Saab: 9-5 (10-12)
	EN-6340, EN-6333, EN-6625, EN-6349

REF		
1645	1,1kg	5x

 Kit sincronização SAAB 2.2D turbo
 Kit calado reglaje SAAB 2.2D turbo



	2.2
	83 95 394/337/352/386
	Saab 9-3
	83 95 394, 337, 352, 386

REF		
1503	2kg	5x

 Kit sincronização Toyota / Mitsubishi
 Kit calado Toyota / Mitsubishi

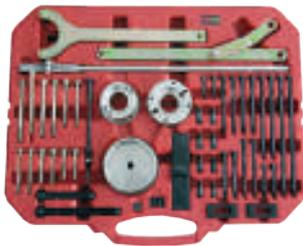

	1.4/1.6/1.8/2.0/2.2/2.4/2.5/2.7/2.8/3.0/4.0/4.7
	4-runner, Auris, Avensis, Camry, Celica, Corolla, Corolla verso, Dyna, Hiace, Hilux, Landcruiser, MR2, Privia, Prius, Rav 4, Scarlet, Yaris
	09278-54012, XB 990757, 09330-0021, 09213-14010, 09213-54015, XD 998738, 09953-05010, 09953-05020, 09957-05010, MD998767, 09952-05010, 09955-05020, 09952-05070, 09954-05061, 09954-05021, 09955-05010, 09954-05080, 09954-05040, 09954-05041, 09955-05030, 09955-05031, 09954-05011, 09954-05051

REF		
1556	10,8kg	1x

 Kit bloqueio eixo Mitsubishi 2.2 DOHC
 Kit bloqueio eje Mitsubishi 2.2 DOHC



	DOHC 2.2
	4HK, 4HN
	Outlander (07-13)
	303-1328 0190D, 303-1329, 303-1330

REF		
1637	675gr	20x

Chave de caixa 1/2" XZN M9 Toyota
 Llave de vaso 1/2" XZN M9 Toyota



	VAG
--	-----

REF				
12109L	M9	140mm	110gr	1x

Ferramenta bloqueio polia cambota 1.0/1.2 Gasolina Toyota
 Herramienta bloqueo polea cigueñal 1.0/1.2 Gasolina Toyota



	EBO 1.0 e EB2 1.2 3 cilindros de correa molhada EBO 1.0 y EB2 1.2 de 3 cilindros con correa húmeda
	Toyota

REF		
1701	784gr	20x

Kit sincronização Toyota 1.0/1.2 GDI
 Kit calado Toyota 1.0/1.2 GDI



Medidor controlo correia sincronismo
 Medidor controlo correia sincronismo

 REF 1707-01

	1.0/1.2
	Aygo (14-18)

Nota: Para códigos de motor, consultar website
Nota: Para códigos de motor, consultar sitio web

REF		
1707	740gr	5x

Jogo ajuste e bloqueio distribuição Toyota/Mazda/Suzuki/Volvo 1.4/1.6
 Juego ajuste Toyota/Mazda/Suzuki/Volvo 1.4/1.6



	1.4/1.6
	Toyota: Aygo (05-10) Mazda: 2 (02-10), 3 (04-12), 5 (10-12) Suzuki: Liana (04-08), SX4 (07-11) Volvo: C30 (06-13), S40 (04-12), S60 (11-15), S80 (09-15), V40 (12-15), V50 (04-12), V60 (11-15), V70 (11-15)
	Mazda: 49JE02-020, 49JE02-021, 49JE02-018 Suzuki: 09910-05410 Volvo: 999-7169, 999-7122, 999-7121

Nota: Para códigos de motor, consultar website
Nota: Para códigos de motor, consultar sitio web

REF		
1523	650gr	10x

 Kit sincronização Volvo diesel/gasolina 1.5/2.0
 Kit calado Volvo diesel/gasolina 1.5/2.0



	1.5/2.0
	D4204T, B4154, B4204T
	S60 (13-18), S80 (13-18), S90 (2016), V40 (14-19), V60 (13-18), V70 (13-16), V90 (2016), XC40 (2017), XC60 (2013), XC70 (13-16), XC90 (2014)
	999 7490, 999 7497, 999 7495, 999 7233

REF		
1716	7,24kg	2x

 Kit bloqueio árvore de cames Volvo 2.0/2.5
 Kit bloqueo árbol de levas Volvo 2.0/2.5



	2.0/2.5
	C30, C70 II Convertible, S40 II (MS), S60 I, S60 II, S80 I, S80 II, V40, V50, V60, V70 Mk II, V70 III, XC70 Cross Country, XC70 II, XC60, XC90 I
	999 5433, 999 7007, 999 7005

REF		
1669	625gr	18x

 Kit sincronização Volvo 2.0 diesel
 Kit calado Volvo 2.0 diesel



	2.0
	D4204T
	S60 (13-18), S80 (13-16), S90 (16-), V40 (14-19), V60 (13-18), V70 (13-16), V90 (16-), XC40 (17-), XC60 (13-), XC70 (13-16), XC90 (14-)
	999 7490, 999 7497, 999 7495, 999 7233

REF		
1683	1,6kg	5x

 Jogo regulação Volvo 2.4
 Juego ajuste Volvo 2.4



	2.4
	240D, 740, 760, 940, 960TD, 940TD
	2065A, 2064

REF		
1568	200gr	20x

 Bloqueio árvore de cames + volante Volvo/Mazda
 Bloqueo de árbol de levas + volante Volvo/Mazda



	1.25/1.4/1.6/1.7/1.8/2.0 16V Zetec
	Mazda: 121 ZQ (95-00), 2 DY (02-07), 6 GG (02-07), 6 GY (02-07), 3 BK (03-09), 3 BL (09-12), 5 CR (05-10), 5 CW (10-12), 6 GH (07-12), MPV LW (02-05), MX-5 NC (05-12), Tribute EP (04-06) Volvo: C30 (06-12), S40 (06-12), S80 (07-11), V50 (04-12)
	Volvo: 9997152, 9997406, 9997152 Mazda: 49JE01061, 49JE02024

REF		
8762	306gr	50x

 Kit sincronização Mazda 1.4/1.6/1.8/2.0 DURATORQ
 Kit calado Mazda 1.4/1.6/1.8/2.0 DURATORQ



	1.4/1.6 TDCi/1.8 Di/TDCi/TDdi/2.0 TDCi DURATORQ
	2, 3
	21-260 / 303 732, 21-163 / 303 620, 21-210 / 303-507, 21-104/303 193, 21-168 /303 393, 21-229 / 303 651, 21-162B / 303 376, 21-262 / 303 734, 303 1054, 303 748, 303 1097, 303 - 1059, 21-263 / 303 735

Nota: Para códigos de motor, consultar website

Nota: Para códigos de motor, consultar sitio web

REF		
1615	3kg	2x

 Kit sincronização Suzuki 1.3 CDTI
 Kit calado Suzuki 1.3 CDTI



	1.3 CDTI
	Z13DT
	Ingis (03-09), Wagon (03-09), Swift (03-10)
	104-A EN 46781, EN-46785

REF		
1511	1,2kg	5x

 Kit sincronização Suzuki 1.3 diesel
 Kit calado Suzuki 1.3 diesel



Ferr. retenção cambota
Herr. retención cigueñal



REF 1657F

Chave retenção
Llave sujeción



REF 1657A

Acessórios fixação
Accesorios fijación



REF 1657S

Alavanca tensão
Palanca tensor



REF 1657B

	1.3
	Z13DT, Z13DTH, Z13DTJ
	Agila (03-08), Corsa C (03-07), Combo C (03-09), Corsa D (06-09), Astra H (04-09), Tigra B (04-09), Meriva
	KM-662-C, KM 955, EN 46781

REF		
1657	1,8kg	5x

 Kit sincronização Holden/Dodge 2.8L CRD
 Kit calado Holden/Dodge 2.8L CRD



	2.8L CRD
	Dodge: ENS (VM51C/52C)
	Holden: Colorado (12-) Dodge: Nitro (07-11)
	EN-50030 / VM-9992, EN-51025, EN-51104, EN-50029 / VM-9991

REF		
1607	1,3kg	5x

 Bloqueio volante motor Hyundai/KIA 1.0/1.2/1.25/1.4/1.6/2.0/2.2/2.4/ 2.7
 Bloqueo volante motor Hyundai/KIA 1.0/1.2/1.25/1.4/1.6/2.0/2.2/2.4/ 2.7



	1.0/1.2/1.25/1.4/1.6/2.0/2.2/2.4/ 2.7		Hyundai: Accent (11-18), Elantra (07-18), Genesis Coupe (10-14), Santa Fe (09-18), Grand Santa Fe (13-16), Sonata/Sonica (08-10), Tiburon (02-09), Tucson (15-18), Veloster (11-18), H1/H300 (10-11), i10 (08-18), i20 (09-18), iX20 (10-18), i20 Coupe (15-17), i30 (07-18), iX35 (10-16), i40 (11-18), i800/iLoad (10-11), iLoad/iMax (10-11) Kia: Carens (08-18), Ceed (07-18), Magentis/Optima (09-11), Optima (11-18), Picanto (11-18), Pro-Ceed (08-19), Rio (09-18), Sedona/Carnival (10-13), Cerato (10-18), Sorento (10-18), Soul (09-18), Sportage (10-19), Stonic (17-20), Venga (09-18)
	1.0 Gasolina: G3LA, B3LA, G3LC 1.2 Gasolina: G4LA, G4 1.25 Gasolina: G4LA 1.4 Gasolina: G4LC, G4FA, G4FA-L 1.6 Gasolina: G4FC, G4FC-GL, G4FD, G4FJ 2.0 Gasolina: G4KD, G4KF, G4NC, G4NA, G4ND, G4NE 2.0 Diesel: D4HA-H, D4HA-L, D4HA 2.2 Diesel: D4HB 2.4 Gasolina: G4KE, G4KJ 2.7 Gasolina: G6BA		

REF		
1652	600gr	24x

 Bloqueio volante motor KIA/Hyundai 1.1/1.4/1.5/1.6/1.7L
 Bloqueo volante motor KIA/Hyundai 1.1/1.4/1.5/1.6/1.7L



	1.1/1.4/1.5/1.6/1.7L CRDi		Hyundai: Accent (06-10), Accent (11-16), Elantra (07-11), Getz (05-09), i10 (08-14), i20 (09-15), i20 (15-18), i20 Active (16-18), i20 Coupe (15-18), i30 (07-12), i30 (12-17), i40 (11-19), ix20 (10-18), ix35 (10-16), ix55/Vera Cruz (08-13), Matrix (05-11), Tucson (16-18) Kia: Carens (10-13), Carens (13-18), Cee'd / Pro-Cee'd (07-12), Cee'd / Pro-Cee'd (12-18), Cerato (04-07), Optima (11-15), Optima (15-18), Picanto (04-11), Rio (05-11), Rio (11-17), Soul (09-14), Soul (14-19), Sportage (10-16), Sportage (16-18), Venga (09-18)
	1.1 D3FA, 1.4 D4FC, 1.5 D4FA, 1.6 D4FB, 1.7 D4FD, 3.0 D6EA		
	OEM		09231-2A100

REF		
1651	408gr	100x

 Bloqueio carreto bomba alta pressão Hyundai/KIA 1.1/1.4/1.5/1.6/1.7

 Bloqueo carrete bomba alta presión Hyundai/KIA 1.1/1.4/1.5/1.6/1.7

	1.1/1.4/1.5/1.6/1.7
	D3FA, D3FA (U2), D3FF, D4FC (U1), D4FC (U2), D3EA, D4FA-L, D4FA, D4FA-H, D4FB-H (U1), D4FB (U1), D4FB-L (U1), D4FB (U2), D4FB-L (U2), D4FB-H (U2), D4FB, D4FD (U2), D4FD-L (U2), D4FD-H (U2), D4FD
	Hyundai: Matrix (01-11), Accent/Excel (02-15), Getz (03-09), i10 (08-10), Elantra (07-10), i30 (07-16), i20 (09-16), ix35 (10-16), ix20 (10-15), i40 (11-16), i20 Coupe (15-16), Tucson (15-16) Kia: Cerato (04-07), Rio (05-16), Picanto (04-11), Ceed (07-16), Pro-Ceed (08-16), Soul (09-14), Venga (09-15), Sportage (10-16), Carens (10-16), Optima (11-15)
	OEM 09331-2A000

REF



3322

2kg

5x

 Kit sincronização Hyundai/KIA 1.6d belt drive

 Kit calado Hyundai/KIA 1.6d belt drive

	1.6
	D4FE (U3)
	Hyundai: i30 (19-), i40 (18-), Kauai/Kona (18-), Tucson (18-) Kia: Ceed (18-), Optima (18-), ProCeed (19-), Sportage (18-), Stonic (18-), XCeed (19-)
	OEM 09331-2A000

REF



1725

1,9kg

5x

 Kit sincronização Iveco 2.3D/3.0D

 Kit calado Iveco 2.3D/3.0D

	2.3 D/3.0D
	2.3D: F1AE0481A, F1AE0481B, F1AE0481F, F1AE0481FA, F1AE0481G, F1AE0481GA, F1AE0481H, F1AE0481HA, F1AE0481R, F1AE0481RA, F1AE0481UA, F1AE0481VA 3.0D: F1CE0481A, F1CE0481B, F1CE0481F, F1CE0481H
	Daily (03-10), Daily/EcoDaily (09-11)

Nota: Para códigos OEM, consultar website

Nota: Para códigos OEM, consultar sitio web

REF



1520

5kg

2x

FERRAMENTA ELÉTRICA
HERRAMIENTA ELÉCTRICA

09



 FAMÍLIA	PÁGINAS
01 FERRAMENTA MANUAL	11-106
02 ALICATES	109-120
03 BITS E CONJUNTOS	123-134
04 FERRAMENTA ESPECÍFICA	137-214
05 FERRAMENTA CARROÇARIA	217-222
06 REGULAÇÃO E TESTE	225-246
07 FERRAMENTA MOTOR	249-276
08 KITS SINCRONIZAÇÃO	279-350
09 FERRAMENTA ELÉTRICA	353-362
10 FERRAMENTA PNEUMÁTICA	365-378
11 FERRAMENTA HIDRÁULICA	381-404
12 FERRAMENTA LUBRIFICAÇÃO	407-414
13 EQUIPAMENTO GARAGEM	417-502
RT ROUPA DE TRABALHO	505-508
MR MERCHANDISING	511-514
EP EXPOSITORES	517-524
LR LOCALIZAÇÃO REFERÊNCIAS	527-538

 FAMILIA	PÁGINAS
01 HERRAMIENTA MANUAL	11-106
02 ALICATES	109-120
03 PUNTAS Y CONJUNTOS	123-134
04 HERRAMIENTA ESPECÍFICA	137-214
05 HERRAMIENTA DE CARROCERIA	217-222
06 REGULACIÓN Y PRUEBAS	225-246
07 HERRAMIENTA PARA MOTOR	249-276
08 KIT CALADO	279-350
09 HERRAMIENTA ELÉCTRICA	353-362
10 HERRAMIENTA NEUMÁTICA	365-378
11 HERRAMIENTA HIDRÁULICA	381-404
12 HERRAMIENTA LUBRICACIÓN	407-414
13 EQUIPAMENTO PARA TALLER	417-502
RT ROPA DE TRABAJO	505-508
MR MERCHANDISING	511-514
EP EXPOSITORES	517-524
LR LOCALIZACIÓN REFERENCIAS	527-538



 Gambiarra 6W COB LED com dock
 Lámpara 6W COB LED con dock

4 h

3.7 V
2600 mAh

USB

IK07

IP54





 **120**
lm

 **250**
lm

 **600**
lm

 10 h

 4.5 h

 1.7 h



REF				
1087	10/4.5/1.7h	4h	475gr	12x

 Gambiarra 7x0.5W + 3W SMD LED recarregável
 Lámpara 7x0.5W + 3W SMD LED recargable

3.5 h

3.7 V
2200 mAh

USB

IK07

IP20





 **120**
lm

 **400**
lm

 8 h

 3 h



REF				
1093	8/3h	3.5h	500gr	12x

 Gambiarra 7W COB + 3W SMD recarregável
 Lámpara 7W COB + 3W SMD recargable

4 h

3.7 V
2600 mAh

USB

IK07

IP65





 **150**
lm

 **170**
lm

 **300**
lm

 **700**
lm

 7 h

 7 h

 3 h

 1.5 h



REF				
1095	7/3/1.5h	4h	500gr	12x

 Gambiarra 3W COB LED
 Lámpara 3W COB LED

8-10 h

3.7 V
2600 mAh

USB

IP20



2x



 **80-120**
lm

 **200-300**
lm

 6 h

 4 h



REF				
1097	6/4h	8-10h	1kg	20x

 Gamburgarra ultrafina recarregável 7W COB + 3W
 Lámpara ultradelgada recargable 7W COB + 3W

4.15 h  3.7 V 2600 mAh 

IK07 IP54



 **60** lm  16.5 h
 **120** lm  10 h
 **700** lm  1.4 h



REF



1091

16.5/10/1.4h

4.15h

385gr

20x

 Gamburgarra slim 3 LED articulada e recarregável
 Lámpara slim 3 LED articulada y recargable

2.5 h  3.7 V 700 mAh 

IK07 IP54



 **80** lm  3 h
 **100** lm  2 h
 **180** lm  4 h
 **200** lm  2 h



REF



1089

4/3/2h

2.5h

125gr

48x

 Gamburgarra wireless ultra fina dobrável
 Lámpara wireless ultra delgada plegable

3.5 h  3.7 V 2600 mAh 

IP65



 **120** lm  9 h
 **400** lm  4.5 h
 **400** lm  4.5 h
 **800** lm  2.5 h



REF



1154

9/4.5/2.5h

3.5h

285gr

20x

 Lanterna pen recarregável
 Linterna bolígrafo

2.5 h  3.7 V 750 mAh 

IP20



 **100** lm  5 h
 **200** lm  2.5 h
 **300** lm  2 h



REF



1150

5/2.5/2h

2.5h

84gr

50x

 Lanterna flashlight recarregável rotativa 90°
 Linterna flashlight giratoria 90°

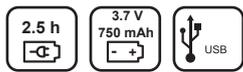

IP65

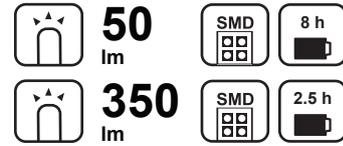

REF	☀	🔋	📏	📦
1151	8/2.5h	2.5h	116gr	50x

 Kit lanternas 12pcs (1150+1151) com display
 Kit linternas 12pzs (1150+ 1151) con display



 **Descrição:**
Kit com lanterna pen recarregável 200LM (6 unidades) e lanterna flashlight recarregável rotativa 90° 350LM (6 unidades)

 **Descripción:**
Kit con linterna bolígrafo 200LM (6 unidades) y linterna flashlight giratoria 90° de 350LM (6 unidades)

REF	📏	📦
1152	2,75kg	2x

 Gambiarra cob bateria wireless
 Lámpara cob bateria wireless



IP65 IK09

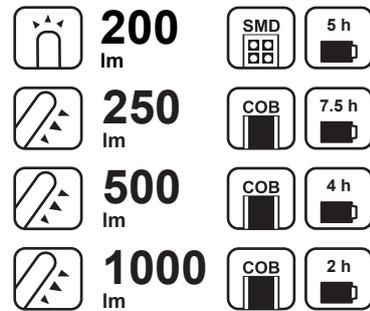

REF	☀	🔋	📏	📦
1082	7.5/5/4/2h	4h	500gr	12x

 Gambiarra ultra-fina recarregável em alumínio
 Lámpara ultra delgada plegable aluminio



IK07 IP54

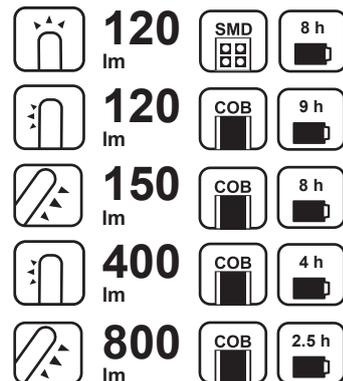

REF	☀	🔋	📏	📦
1157	9/8/4/2.5h	4h	193gr	20x

Carregador USB 5V
 Cargador USB 5V



REF	⚡	📏	📦
1090	5V	50gr	40x

Carregador single wireless
 Cargador single wireless



Características:
 Revestimento TPE de nylon
 Ímãs fortes integrados e furos para parafusos para fixação do carregador
 Carrega equipamentos com funcionalidade wireless
 Suporte para carregar telemóveis
 Potência de saída IDW para carregamento rápido
 Indicador do estado do nível de carga

Acessórios:
 Cabo carregamento rápido USB-C 1M

Características:
 Revestimiento de nylon TPE
 Fuertes imanes integrados y orificios para atornillar el cargador
 Carga dispositivos con funcionalidad wireless
 Soportes para teléfonos móviles
 Potencia de salida IDW para la carga rápida
 Indicador del estado del nivel de carga

Acessorios:
 Cable carga rápido USB-C 1M

REF	📏	📦
1083	335gr	12x

Carregador dual wireless
 Cargador dual wireless



Características:
 Revestimento TPE de nylon
 Ímãs fortes integrados e furos para parafusos para fixação do carregador
 Carrega equipamentos com funcionalidade wireless
 Suporte para carregar telemóveis
 Duas saídas de potência de 10W podem simultaneamente carregar rapidamente dois dispositivos
 Indicador do estado do nível de carga

Especificações:
 Carregador: 5V,2A ou QC3.0, carregador rápido de 18W

Acessórios:
 Cabo de carregamento rápido tipo-C de 1M

Características:
 Revestimiento de nylon TPE
 Fuertes imanes integrados y orificios para atornillar el cargador
 Carga dispositivos con funcionalidad wireless
 Soportes para teléfonos móviles
 Dos salidas con potencia 10W pueden cargar simultáneamente dos dispositivos
 Indicador del estado del nivel de carga

Especificaciones:
 Carregador: 5V,2A o QC3.0, 18W cargamento rápido

Acessorios:
 Cable carga rápido USB-C 1M

REF	📏	📦
1084	500gr	12x

 Gambiarra de cabeça c/sensor movimento 700LM
 Faro con sensor de movimiento 700LM

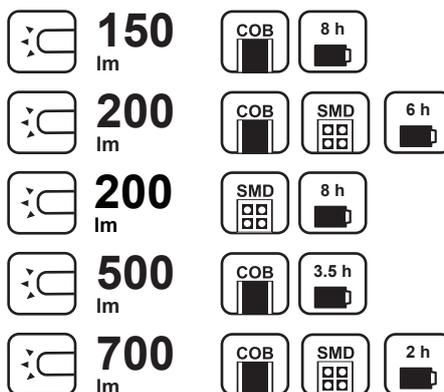
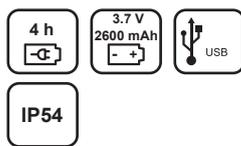

REF				
1155	8/6/3.5/2h	4h	187gr	32x

 Lâmpada LED touch 500mm (380LM)
 Lámpara LED touch 500mm (380LM)



 **Características:**
Potência: 5W
Fluxo luminoso: 380 Lumens
Intensidade: 0-100%
Voltagem: 100-240V AC

 **Características:**
Potencia: 5W
Flujo luminoso: 380 Lúmenes
Intensidad: 0-100%
Voltaje: 100-240V CA

REF		
1099	260gr	30x

 Foco com focagem 3WAT 3 pilhas aaa(incluídas)
 Linterna 3WATTS



 **Características:**
Estrutura alumínio
Saída de 140 lumens
LEDS brilhantes de 3W com focagem ajustável
Funciona com 3x pilhas AAA (incluídas)

 **Características:**
Estructura en aluminio
Salida de 140 lúmenes
LEDs brilhantes de 3W con foco ajustable
Funciona con 3x pilas AAA (incluidas)

REF			
1070	3x AAA	200gr	6x

 Gambiarra 8W COB 5m cabo
 Lámpara 8W COB led 5m cable



 **Características:**
Diâmetro cabo elétrico: 75mm²
Comprimento: 5m
Gancho giratório: 360°
Tipo lâmpada: COB LED
Fonte de Energia: 230V AC
Classificação: IP44

 **Características:**
Diámetro cable eléctrico: 75mm²
Longitud: 5m
Gancho giratorio: 360°
Tipo lámpara: COB LED
Fuente de energía: 230V AC
Clasificación: IP44

REF			
1057	5m	1,3kg	10x

Gambiarra COB 5W
 Lámpara COB 5W



Suporte fixação
 Soporte fijación



REF 1078

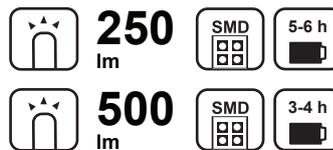

REF	☀	🔋	📏	📦
1077	5-6h/3-4h	3-4h	184gr	50x

Caixa carregadora 3pcs para 1077
 Caja de cargador 3pzs para 1077



Características:

Caixa Carregadora específica para 3 unidades da gambiarra Ref: 1077 (Gambiarra COB 5W)
 Material principal: ABS
 Bateria: 3.7 V; 2600 mAh Li-ion
 Carregador: 230V AC 12V/24V DC
 Composição: Carregador AC e de carro
 Botão: 50%-100%-OFF
 LUZ: 3*5W COB LED
 Fonte de luz:1500Lm (conjunto completo)
 Tempo carregamento: 3-4h
 Tempo funcionamento: 3-4h (100%), 5-6h (50%)

⚠ **NOTA:** Gambiarras não incluídas

Características:

Caja cargador específica para 3 unidades de la gambiarra Ref: 1077 (Gambiarra COB 5W)
 Material principal: ABS
 Bateria: 3.7 V; 2600 mAh Li-ion
 Cargador: 230 V CA 12 V / 24 V CC
 Composición: AC y cargador de coche
 Botón: 50% -100% -OFF LIGHT: 3 * 5W COB LED
 Fuente de luz: 1500Lm (juego completo)
 Tiempo de carga: 3-4h
 Tiempo de trabajo: 3-4h (100%), 5-6h (50%)

⚠ **NOTA:** Lámparas no incluídas

REF	☀	📏	📦
1079	3-4h	1,6kg	8x

Gambiarra bolso COB + 3 LEDS bateria
 Lámpara bolsillo 2W COB + 3SMD

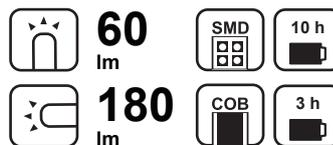

REF	☀	🔋	📏	📦
1062	10/3h	4-5h	275gr	20x

 Gambiarra KROF 4W COB + 1W UV LED
 Lámpara KROF 4W COB + 1W UV LED





3 h

3.7 V
2000 mAh

USB

200
lm

400
lm

COB

4 h

COB

2 h



REF	☀	🔌	📏	📦
1096	4/2h	3h	310gr	10x

 Lanterna caneta recarregável 6+1 COB LED
 Linterna bolígrafo recargable 6+1 COB LED





3-4 h

3.6V
600mAh

USB

10
lm

60
lm

20 h

3 h

REF	☀	🔌	📏	📦
1075	20/3h	3-4h	85gr	12x

 Lanterna caneta COB LED pilhas AAA
 Linterna bolígrafo COB LED pilas AAA



4-5 h

3x
AAA

USB



100
lm

COB

3 h

REF	☀	🔌	📏	📦
1074	3h	4-5h	62gr	12x

 Gambiarra ponta flexível
 Lámpara 5w tubo flexible



Led: 17.4x495mm



4-5 h

7.4 V
2200 mAh

USB



40
lm

400
lm

20 h

4 h

REF	☀	🔌	📏	📦
1068	4-20h	4-5h	550gr	10x

Gambiarras inspeção ultra fina
 Lámpara de inspección ultrafina

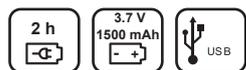

IP65

100
 lm

6 h
150
 lm

6 h
400
 lm

2.5 h

REF



1153

6/2.5h

2h

165gr

20x

Projektor 1500LM c/ powerbank
 Proyector 1500LM con powerbank



IP65

150
 lm

25 h
375
 lm

12 h
750
 lm

6 h
1125
 lm

4 h
1500
 lm

3 h

REF



1156

25/12/6/4/3h

2.5h

733gr

12x

Projektor 50wat cob led c/bateria
 Proyector 50w cob led con bateria

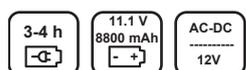

3-4 h

3500
 lm

3-4 h

REF



1046

3-4h

3-4h

3,4kg

1x

Gambiarras de capô 2000LM SMD LED
 Lámpara capô del coche 2000LM SMD LED



IP20

IK07

500
 lm

9 h
1000
 lm

6 h
2000
 lm

3 h

Características:
 Abertura: 1170-1970mm
 Soportes borracha
 Altura soportes: 110mm

Características:
 Apertura: 1170-1970mm
 Soportes de goma
 Altura soportes: 110mm

REF



1086

9/6/3h

4h

1,1kg

1x

- Gambiarra 176 LEDS para capô de automóvel (1300LM)
- Lámpara 176 LED para capô de coche (1300LM)



Características:
Abertura: 1270-2100mm
Consumo de energia: 15W
Comprimento cabo: 4,85m

Características:
Abertura: 1270-2100mm
Consumo de energia: 15W
Longitud cable: 4,85m

REF	☒	⚖️	📦
1054	4,85m	2,25kg	4x

- Tripé para projetor
- Tripode para proyector



Características:
Altura tripé: 720-1600mm
Compatível com Projetor Powerbank Ref: 1156
⚠️ Aviso: Projetor não incluído, vendido separadamente

Características:
Altura tripode: 720-1600mm
Compatible con Proyector Powerbank Ref: 1156
⚠️ Advertencia: Proyector no está incluido, se vende por separado

REF	⚖️	📦
1052	3,3kg	6x

 Chave de impacto 1/2" 650Nm bateria 18V

 Llave de impacto 1/2" 650Nm bateria 18V

Características:
 Quadra 1/2" (12,7mm)
 Potência: 650Nm
 Velocidade sem carga: (L) 0~900 / min, (M) 0~1200 / min
 (H) 0~1900 / 500 / min
 Impacto por minuto: (L) 0-1200IPM, (M) 0-1600IPM
 (H) 0-2400IPM
 Altura: 260mm / Comprimento: 200mm
Bateria:
 Tensão de carregamento: 18V
 Corrente de carga rápida: 3A ± 0.3A
 Manutenção de carga: 200mA ± 50mA
 Tempo de carregamento da bateria a 20°C 4,0Ah - Aprox. ≤ 90 min

Características:
 Cuadrado 1/2" (12,7mm)
 Potencia: 650Nm
 Velocidad sin carga: (L) 0~900 / min, (M) 0~1200 / min
 (H) 0~1900 / 500 / min
 Impacto por minuto: (L) 0-1200IPM, (M) 0-1600IPM
 (H) 0-2400IPM
 Altura: 260mm / Largo: 200mm
Bateria:
 Tensión de carga: 18V
 Corriente de carga rápida: 3A ± 0.3A
 Mantenimiento de carga: 200mA ± 50mA
 Tiempo de carga de la batería a 20°C 4,0Ah - ≤ Aprox. 90 min

REF

9900



18V



5,35kg



4x

 Kit chave impacto 1/2" + rebarbadora 18V

 Kit llave impacto 1/2" + amoladora 18V

Características:
Chave de impacto
 Entrada: 18V DC
 Velocidade sem carga: 0-2200RPM
 Taxa impacto: 0-2600BPM
 Potência máxima: 400NM
 Potência bateria: 4.0Ah Li-ion
 Quadra: 1/2"

Rebarbadora
 Entrada: 18V DC
 Velocidade sem carga: 8500min
 Diâmetro disco: 115mm
 Rosca eixo: M14
 Potência bateria: 4.0Ah Li-ion

Características:
Llave de impacto
 Entrada: 18V DC
 Velocidad sin carga: 0-2200 RPM
 Tasa de impacto: 0-2600BPM
 Potencia máxima: 400NM
 Potencia batería: Li-ion 4.0Ah
 Cuadrado: 1/2"

Amoladora
 Entrada: 18V DC
 Velocidad sin carga: 8500RPM
 Diámetro del disco: 115mm
 Rosca husillo: M14
 Potencia batería: 4.0Ah Li-ion

REF

9910



8kg



2x

FERRAMENTA PNEUMÁTICA
HERRAMIENTA NEUMÁTICA

10



KROFtools
PROFESSIONAL TOOLS

 FAMÍLIA	PÁGINAS
01 FERRAMENTA MANUAL	11-106
02 ALICATES	109-120
03 BITS E CONJUNTOS	123-134
04 FERRAMENTA ESPECÍFICA	137-214
05 FERRAMENTA CARROÇARIA	217-222
06 REGULAÇÃO E TESTE	225-246
07 FERRAMENTA MOTOR	249-276
08 KITS SINCRONIZAÇÃO	279-350
09 FERRAMENTA ELÉTRICA	353-362
10 FERRAMENTA PNEUMÁTICA	365-378
11 FERRAMENTA HIDRÁULICA	381-404
12 FERRAMENTA LUBRIFICAÇÃO	407-414
13 EQUIPAMENTO GARAGEM	417-502
RT ROUPA DE TRABALHO	505-508
MR MERCHANDISING	511-514
EP EXPOSITORES	517-524
LR LOCALIZAÇÃO REFERÊNCIAS	527-538

 FAMILIA	PÁGINAS
01 HERRAMIENTA MANUAL	11-106
02 ALICATES	109-120
03 PUNTAS Y CONJUNTOS	123-134
04 HERRAMIENTA ESPECÍFICA	137-214
05 HERRAMIENTA DE CARROCERIA	217-222
06 REGULACIÓN Y PRUEBAS	225-246
07 HERRAMIENTA PARA MOTOR	249-276
08 KIT CALADO	279-350
09 HERRAMIENTA ELÉCTRICA	353-362
10 HERRAMIENTA NEUMÁTICA	365-378
11 HERRAMIENTA HIDRÁULICA	381-404
12 HERRAMIENTA LUBRICACIÓN	407-414
13 EQUIPAMENTO PARA TALLER	417-502
RT ROPA DE TRABAJO	505-508
MR MERCHANDISING	511-514
EP EXPOSITORES	517-524
LR LOCALIZACIÓN REFERENCIAS	527-538



Chave de impacto 1/2" 1112/1756Nm (duplo martelo)
Llave de impacto 1/2" 1112/1756Nm (doble martillo)



Requer tubo de ar com diâmetro interno mínimo 10mm.
Se requiere tubo de aire con un diámetro interno mínimo de 10mm.

Características:
Carcaça em composite
Velocidade: 8,000rpm
Força aperto: 1112Nm
Força (máx.) desaperto: 1756Nm
Quadra: 1/2" (13mm)
Consumo de ar: 113L/m
Entrada ar: 1/4"
Pressão sonora: 92,4dB(A)
Potência sonora: 103,4dB(A)
Pressão ar recomendada: 90psi (6.2BAR)

Características:
Carcaça em composite
Velocidad: 8,000rpm
Fuerza apriete: 1112Nm
Fuerza (máx.) afloje: 1756Nm
Carraca: 1/2" (13mm)
Consumo de aire: 113L/m
Entrada de aire: 1/4"
Presión sonora: 92,4dB(A)
Potencia sonora: 103,4dB(A)
Presión aire recomendada: 90psi (6.2BAR)

REF	↻	↻	↔	⚖️	📦
9200	1756Nm	1112Nm	187mm	2kg	10x

Jogo de chave impacto 1/2" 1112/1756Nm
Juego de llave impacto 1/2" 1112/1756Nm



Requer tubo de ar com diâmetro interno mínimo 10mm.
Se requiere tubo de aire con un diámetro interno mínimo de 10mm.

Características:
Carcaça em composite
Velocidade: 8,000rpm
Força aperto: 1112Nm
Força (máx.) desaperto: 1756Nm
Quadra: 1/2" (13mm)
Consumo de ar: 113L/m
Pressão sonora: 92,4dB(A)
Potência sonora: 103,4dB(A)
Entrada de ar: 1/4"
Pressão ar recom: 90psi (6.2BAR)
Composição:
(10x) Chaves caixa 1/2" curto imp: 9,10,11,13,14,17,19,22,24,27mm
(1x) Aumento de imp. 1/2" 125mm
(1x) Chave umbrako em L

Características:
Carcaça em composite
Velocidad: 8,000rpm
Fuerza apriete: 1112Nm
Fuerza (máx.) afloje: 1756Nm
Carraca: 1/2" (13mm)
Consumo de aire: 113L/m
Presión sonora: 92,4dB(A)
Potencia sonora: 103,4dB(A)
Entrada de aire: 1/4"
Presión aire recom: 90psi (6.2BAR)
Composición:
(10x) Llaves vaso hex. imp. 1/2": 9,10,11,13,14,17,19,22,24,27mm
(1x) Alargadera imp. 1/2" 125mm
(1x) Llave umbrako L

REF	↻	↻	↔	⚖️	📦
9202	1756Nm	1112Nm	187mm	2,8kg	5x

Chave de impacto 1/2" angular 325Nm
Llave de impacto 1/2" angular 325Nm



Requer tubo de ar com diâmetro interno mínimo 10mm.
Se requiere tubo de aire con un diámetro interno mínimo de 10mm.

Características:
Quadra: 1/2" (13mm)
Velocidade: 8,500rpm
Potência máxima: 325Nm
Intervalo de potência de trabalho: 27-237Nm
Entrada de ar: 1/4"
Diâmetro mangueira: 3/8" (10mm)
Pressão sonora: 87,9dB(A)
Potência sonora: 98,9dB(A)
Pressão de ar: 90psi (6.2BAR)
Consumo médio de ar: 113L/min

Características:
Carraca: 1/2" (13mm)
Velocidad: 8500rpm
Potencia máxima: 325Nm
Rango de potencia de trabajo: 27-237Nm
Entrada de aire: 1/4"
Diámetro manguera: 3/8" (10mm)
Presión sonora: 87,9dB(A)
Potencia sonora: 98,9dB(A)
Presión de aire: 90psi (6.2 BAR)
Consumo medio de aire: 113L/min

REF	↻	↔	⚖️	📦
9279	325Nm	90mm	1,2kg	10x

Chave de impacto angular 1/2" 900Nm
Llave de impacto 1/2" 900Nm



Requer tubo de ar com diâmetro interno mínimo 10mm.
Se requiere tubo de aire con un diámetro interno mínimo de 10mm.

Características:
Quadra: 1/2"
Velocidade: 7500rpm
Potência máxima: 900Nm
Intervalo de potência de trabalho: 20-450Nm
Entrada de ar: 1/4"
Diâmetro mangueira: 3/8" (10mm)
Pressão sonora: 92,4dB(A)
Potência sonora: 103,4dB(A)
Pressão de ar: 6.3bar
Consumo médio de ar: 142L/min

Características:
Carraca: 1/2"
Velocidad: 7500rpm
Potencia máxima: 900Nm
Rango de potencia de trabajo: 20-450Nm
Entrada de aire: 1/4"
Diámetro manguera: 3/8" (10mm)
Presión sonora: 92,4dB(A)
Potencia sonora: 103,4dB(A)
Presión de aire: 6.3bar
Consumo medio de aire: 142L/min

REF	↻	↔	⚖️	📦
9243	900Nm	99mm	1,7kg	10x

 Mini máquina de impacto 1/2" 1200Nm
 Mini máquina de impacto 1/2" 1200Nm



 Requer tubo de ar com diâmetro interno mínimo 10mm.
 Se requiere tubo de aire con un diámetro interno mínimo de 10mm.

<p> Características: Velocidade: 10,000rpm Força aperto: 850Nm Força max. desaperto: 1200Nm Consumo de ar: 141,5L/min Pressão de ar: 90psi (6,3BAR)</p>	Entrada de ar: 1/4" Pressão de trabalho: 6.3 BAR Pressão sonora: 96.6dB(A) Potência sonora: 107.6dB(A)
--	---

<p> Características: Velocidad: 10,000rpm Fuerza apriete: 850Nm Fuerza (máx.) afloje: 1200Nm Consumo de aire: 141,5L/min Presión de aire: 90psi (6,3BAR)</p>	Entrada de aire: 1/4" Presión de trabajo: 6,3BAR Presión sonora: 96.6dB(A) Potencia sonora: 107.6dB(A)
---	---

REF

9245

 1200Nm

 850Nm

 1,28kg

 10x

 Máquina de impacto 1/2" 1750Nm
 Llave de impacto 1/2" 1750Nm



 Requer tubo de ar com diâmetro interno mínimo 10mm.
 Se requiere tubo de aire con un diámetro interno mínimo de 10mm.

<p> Características: Velocidade: 8000rpm Força aperto: 1750Nm Força max. desaperto: 1750Nm Consumo de ar: 184L/min Pressão de ar: 90psi (6,3BAR)</p>	Entrada de ar: 1/4" Pressão de trabalho: 6.3 BAR Pressão Sonora: 97.3dB(A) Potência Sonora: 108.3 dB(A)
---	--

<p> Características: Velocidad: 8000rpm Fuerza apriete: 1750Nm Fuerza (máx.) afloje: 1750Nm Consumo de aire: 184L/min Presión de aire: 90psi (6,3BAR)</p>	Entrada de aire: 1/4" Presión trabajo: 6,3BAR Presión sonora: 97.3dB(A) Potencia sonora: 108.3 dB(A)
--	---

REF

9242

 1750Nm

 1750Nm

 2,15kg

 10x

 Máquina de impacto 3/4" 2000nm
 Llave de impacto 3/4" 2000nm



 Requer tubo de ar com diâmetro interno mínimo 13mm.
 Se requiere tubo de aire con un diámetro interno mínimo de 13mm.

<p> Características: Velocidade: 7000rpm Força aperto: 2000Nm Força max. desaperto: 2000Nm Consumo de ar: 184L/min Entrada de ar: 3/8"</p>	Pressão de trabalho: 6.3bar Pressão sonora: 95.2dB(A) Potência sonora: 106.2dB(A)
---	---

<p> Características: Velocidad: 7000rpm Fuerza apriete: 2000Nm Fuerza (máx.) afloje: 2000Nm Consumo de aire: 184L/min Entrada de aire: 3/8"</p>	Presión trabajo: 6.3bar Presión sonora: 95.2dB(A) Potencia sonora: 106.2dB(A)
--	---

REF

9246

 2000Nm

 2000Nm

 2,4kg

 10x

 Máquina de impacto 1" 3800Nm
 Llave de impacto 1" 3800Nm



 Requer tubo de ar com diâmetro interno mínimo 1/2"/12.7mm.
 Se requiere tubo de aire con un diámetro interno mínimo de 1/2"/12.7mm.

<p> Características: Velocidade: 3600rpm Força aperto: 3800Nm Força (máx.) desaperto: 3800Nm Quadra: 1" / 25.4mm Capacidade diâmetro do parafuso: M40mm</p>	Consumo de ar: 396L/min Entrada de ar: 1/2" Pressão Sonora: 94.8dB(A) Potência Sonora: 105.8dB(A) Pressão de ar: 6.3bar Tamanho da mangueira: 1/2"/12.7mm
--	--

<p> Características: Velocidad: 3600rpm Fuerza apriete: 3800Nm Fuerza (máx.) afloje: 3800Nm Carraca: 1" / 25.4mm Capacidad diámetro del tornillo: M40mm</p>	Consumo de aire: 396L/min Entrada de aire: 1/2" Presión Sonora: 94.8dB(A) Potencia Sonora: 105.8dB(A) Presión de aire: 6.3bar Tamaño de la manguera: 1/2"/12.7mm
--	---

REF

9247

 3800Nm

 3800Nm

 16,6kg

 1x

 Máquina de impacto 1" 2500Nm
 Llave de impacto 1" 2500Nm



! Requer tubo de ar com diâmetro interno mínimo 1/2"/12.7mm. Se requiere tubo de aire con un diámetro interno mínimo de 1/2"/12.7mm.

 **Características:**
Velocidade: 5000rpm
Força aperto: 2500Nm
Força (máx.) desaperto: 2500Nm
Quadra: 1"
Capacidade diâmetro do parafuso: M27mm

Consumo de ar: 340L/min
Entrada de ar: 1/2"
Pressão sonora: 95.2dB(A)
Potência sonora: 106.2dB(A)
Pressão de ar: 6.3bar
Tamanho da mangueira: 1/2"/12.7mm

 **Características:**
Velocidad: 5000rpm
Fuerza apriete: 2500N.m
Fuerza (máx.) afloje: 2500N.m
Carraca: 1"
Capacidad diámetro del tornillo: M27mm

Consumo de aire: 340L/min
Entrada de aire: 1/2"
Presión sonora: 95.2dB(A)
Potencia sonora: 106.2dB(A)
Presión de aire: 6.3bar
Tamaño de la manguera: 1/2"/12.7mm

REF				
9248	2500Nm	2500Nm	8,4	2x

 Roquete pneumático 1/4" 41Nm
 Carraca neumática 1/4" 41Nm



 **Características:**
Velocidade: 200rpm
Quadra: 1/4"
Força máxima desaperto: 41Nm
Intervalo de trabalho: 0-41Nm
Entrada de ar: 1/4"
Diâmetro mangueira: 3/8"

Consumo médio de ar: 4 CFM
Comprimento: 170mm
Pressão sonora: LpA: 86 dB(A)
LwA: 97 dB(A)
Potência sonora: KpA: 3 dB(A)
KwA: 3 dB(A)

 **Características:**
Velocidad: 200rpm
Carraca: 1/4"
Fuerza maxima: 41Nm
Rango fuerza trabajo: 0-41Nm
Aire entrada: 1/4"

Diametro mangueira: 3/8"
Consumo de aire: 4 CFM
Longitud: 170mm
Presión sonora: LpA: 86 dB(A)
LwA: 97 dB(A)
Potencia sonora: KpA: 3 dB(A)
KwA: 3 dB(A)

REF					
9319	41Nm	41Nm	170mm	600gr	20x

 Berbequim reto pneumático 3/8" 2500rpm
 Taladro recto neumático 3/8" 2500rpm



 **Características:**
Velocidade: 2500rpm
Diâmetro bucha: 3/8"
Entrada de ar: 1/4"
Diâmetro mangueira: 3/8"

Pressão de ar: 90 PSI
Pressão sonora: LpA: 78,1 dB(A)
KpA: 3 dB(A)
Potência sonora: LwA: 89,1 dB(A)
KwA: 3 dB(A)
Consumo médio de ar: 6.5 CFM

 **Características:**
Velocidad: 2500rpm
Diám. porta brocas: 3/8"
Entrada de aire: 1/4"
Diámetro mangueira: 3/8"

Presión de aire: 90 PSI
Presión sonora: LpA: 78,1 dB(A)
KpA: 3 dB(A)
Potencia sonora: LwA: 89,1 dB(A)
KwA: 3 dB(A)
Consumo medio de aire: 6.5 CFM

REF			
9378	230mm	1kg	20x

 Roquete pneumático 1/2" 68Nm (sem martelo)
 Carraca neumática 1/2" 68Nm (sin martillo)



 **Características:**
Velocidade: 150rpm
Quadra: 1/2" (13mm)
Força máxima desaperto: 68Nm
Intervalo de trabalho: 14-68Nm
Entrada de ar: 1/4"

Diâmetro mangueira: 3/8" (10mm)
Consumo de ar: 4 CFM (113L/min)
Comprimento: 256mm
Pressão sonora: 81dB(A)
Potência sonora: 92dB(A)

 **Características:**
Velocidad: 150rpm
Carraca: 1/2" (13mm)
Fuerza maxima: 68Nm
Rango fuerza trabajo: 14-68Nm
Entrada de aire: 1/4"

Diametro mangueira: 3/8" (10mm)
Consumo de aire: 4 CFM (113L/min)
Longitud: 256mm
Presión sonora: 81dB(A)
Potencia sonora: 92dB(A)

REF					
9221	68Nm	68Nm	256mm	1,2kg	20x

 Roquete pneumático 1/2" 69Nm

 Carraca neumática 1/2" 69Nm

Características:
 Velocidade: 160 rpm
 Quadra: 1/2"
 Força máxima desaperto: 69Nm
 Intervalo de trabalho: 0-69Nm
 Entrada de ar: 1/4"
 Diâmetro mangueira: 3/8"

Consumo médio de ar: 4 CFM
 Comprimento: 265mm
 Pressão sonora: LpA: 86 dB(A)
 LwA: 97 dB(A)
 Potência sonora: KpA: 3 dB(A)
 KwA: 3 dB(A)

Características:
 Velocidad: 160 rpm
 Carraca: 1/2"
 Fuerza máxima: 69Nm
 Rango fuerza trabajo: 0-69Nm
 Entrada de aire: 1/4"
 Diámetro manguera: 3/8"

Consumo de aire: 4 CFM
 Longitud: 265mm
 Presión sonora: LpA: 86 dB(A)
 LwA: 97 dB(A)
 Potencia sonora: KpA: 3 dB(A)
 KwA: 3 dB(A)

REF					
9321	69Nm	69Nm	265mm	1,3kg	20x

 Roquete pneumático 1/2" 85Nm

 Carraca neumática 1/2" 85Nm

Características:
 Velocidade: 180 rpm
 Quadra: 1/2"
 Força máxima desaperto: 85Nm
 Intervalo de trabalho: 0-85Nm
 Entrada de ar: 1/4"
 Diâmetro mangueira: 3/8"

Consumo médio de ar: 4 CFM
 Comprimento: 235mm
 Pressão sonora: LpA: 86 dB(A)
 LwA: 97 dB(A)
 Potência sonora: KpA: 3 dB(A)
 KwA: 3 dB(A)

Características:
 Velocidad: 180 rpm
 Carraca: 1/2"
 Fuerza máxima: 85Nm
 Rango fuerza trabajo: 0-85Nm
 Entrada de aire: 1/4"
 Diámetro manguera: 3/8"

Consumo de aire: 4 CFM
 Longitud: 235mm
 Presión sonora: LpA: 86 dB(A)
 LwA: 97 dB(A)
 Potencia sonora: KpA: 3 dB(A)
 KwA: 3 dB(A)

REF					
9381	85Nm	85Nm	235mm	1,1	20x

 Berbequim composite 2000rpm reversível bucha 10mm

 Taladro composite 2000rpm reversible bucha 10mm

Características:
 Carcaça em composite
 Velocidade: 2000rpm
 Entrada de ar: 1/4"
 Consumo de ar: 113L/min

Pressão de ar recomendada:
 90psi (6.2BAR)
 Pressão sonora: 89dB(A)
 Potência sonora: 100dB(A)
 Capacidade porta brocas: 10mm
 Sentido: direita e esquerda

Características:
 Carcasa en composite
 Velocidad: 2000rpm
 Entrada de aire: 1/4"
 Consumo de aire: 113L/min

Presión de aire recomendada:
 90psi (6.2BAR)
 Presión sonora: 89dB(A)
 Potencia sonora: 100dB(A)
 Capacidad porta brocas: 10mm
 Sentido: derecha e izquierda

REF				
9230	195mm	1kg	10x	

 Berbequim composite 2200rpm reversível bucha 10mm

 Taladro composite 2200rpm reversible bucha 10mm

Características:
 Carcaça em composite
 Velocidade: 2200rpm
 Entrada de ar: 1/4"
 Consumo de ar: 6.5 CFM

Pressão de ar recomendada:
 90 PSI
 Pressão sonora: LpA: 78,1 dB(A)
 KpA: 3 dB(A)
 Potência sonora: LwA: 89,1 dB(A)
 KwA: 3 dB(A)
 Comprimento: 212mm

Características:
 Carcasa en composite
 Velocidad: 2200rpm
 Entrada de aire: 1/4"
 Consumo de aire: 6.5 CFM
 Presión de aire recomendada:
 90 PSI

Presión sonora: LpA: 78,1 dB(A)
 KpA: 3 dB(A)
 Potencia sonora: LwA: 89,1 dB(A)
 KwA: 3 dB(A)
 Longitud: 212mm

REF				
9330	212mm	1,2kg	10x	

 Berbequim angular composite 1400rpm reversível bucha 10mm
 Taladro angular composite 1400rpm reversible bucha 10mm



 **Características:**
 Carcaça em composite
 Velocidade: 1400rpm
 Entrada de ar: 1/4"
 Capacidade porta broca: 3/8"
 Diâmetro mangueira de ar: 3/8"
 Saída de ar: 1/4"
 Pressão ar recomendada: 90 PSI
 Consumo de ar: 5.5 CFM
 Pressão sonora: LpA: 86,0 dB(A)
 KpA: 3 dB(A)
 Potência sonora: LwA: 97,1 dB(A)
 KwA: 3 dB(A)

 **Características:**
 Carcasa en composite
 Velocidad: 1400rpm
 Entrada de aire: 1/4"
 Capacidad porta broca: 3/8"
 Diámetro manguera de aire: 3/8"
 Salida de aire: 1/4"
 Presión aire recomendada: 90 PSI
 Consumo de aire: 5.5 CFM
 Presión sonora: LpA: 86,0 dB(A)
 KpA: 3 dB(A)
 Potencia sonora: LwA: 97,1 dB(A)
 KwA: 3 dB(A)

REF	↔	📏	📦
9335	205mm	1,25kg	10x

 Berbequim angular composite 1500rpm reversível
 Taladro angular composite 1500rpm reversible



 **Características:**
 Carcaça em composite
 Velocidade: 1500rpm
 Entrada de ar: 1/4"
 Capacidade porta broca: 10mm
 Diâmetro mangueira de ar: 3/8"
 Saída de ar: traseira
 Pressão ar recomendada: 90psi (6.2BAR)
 Consumo de ar: 4CFM (113L/min)
 Pressão sonora: 85,2dB(A)
 Potência sonora: 96,2dB(A)

 **Características:**
 Carcasa en composite
 Velocidad: 1500rpm
 Entrada de aire: 1/4"
 Capacidad porta broca: 10mm
 Diámetro manguera de aire: 3/8"
 Salida de aire: trasera
 Presión aire recomendada: 90psi 6.2BAR
 Consumo de aire: 4CFM (113L/min)
 Presión sonora: 85,2dB(A)
 Potencia sonora: 96,2dB(A)

REF	↔	📏	📦
9235	200mm	1,1kg	10x

 Retificadora pneumática angular 90° 20000rpm
 Amoladora neumática angular 90° 20000rpm



 **Características:**
 Velocidade: 20000rpm
 Pinças: 1/4" (6mm)
 Entrada de ar: 1/4"
 Diâmetro mangueira: 3/8" (10mm)
 Altura cabeça roquete: 70mm
 Pressão de ar: 90psi (6.2BAR)
 Consumo médio de ar: 93L/min
 Pressão Sonora: 84dB(A)
 Potência Sonora: 95dB(A)

 **Características:**
 Velocidad: 20000rpm
 Pinzas: 1/4" (6mm)
 Entrada de aire: 1/4"
 Diámetro manguera: 3/8" (10mm)
 Altura cabeza carraca: 70mm
 Presión de aire: 90psi (6.2BAR)
 Consumo medio de aire: 93L/min
 Presión Sonora: 84dB(A)
 Potencia Sonora: 95dB(A)

REF	↔	📏	📦
9277	190mm	900gr	10x

 Retificadora pneumática angular 90° 20000rpm
 Amoladora neumática angular 90° 20000rpm



 **Características:**
 Velocidade: 20000rpm
 Pinças: 1/4"
 Entrada de ar: 1/4"
 Diâmetro mangueira: 3/8"
 Altura cabeça roquete: 77.4mm
 Pressão de ar: 90 PSI
 Consumo médio de ar: 4 CFM
 Pressão sonora: LpA: 88,6 dB(A)
 KpA: 3 dB(A)
 Potência sonora: LwA: 99,6 dB(A)
 KwA: 3 dB(A)

 **Características:**
 Velocidad: 20000rpm
 Pinzas: 1/4"
 Entrada de aire: 1/4"
 Diámetro manguera: 3/8"
 Altura cabeza carraca: 77.4mm
 Presión de aire: 90 PSI
 Consumo medio de aire: 4 CFM
 Presión sonora: LpA: 88,6 dB(A)
 KpA: 3 dB(A)
 Potencia sonora: LwA: 99,6 dB(A)
 KwA: 3 dB(A)

REF	↔	📏	📦
9377	175mm	650gr	10x

 Retificadora pneumática 22000 rpm

 Amoladora neumática 22000 rpm

 **Características:**

Velocidade: 25000rpm
 Entrada de ar: 1/4"
 Capacidade porta broca: 1/4"
 Diâmetro mangueira de ar: 3/8"
 Saída de ar: 1/4"

Pressão ar recomendada: 90 PSI
 Consumo de ar: 4 CFM
 Pressão sonora: LpA: 88,6 dB(A)
 KpA: 3 dB(A)
 Potência sonora: LwA: 99,6 dB(A)
 KwA: 3 dB(A)

 **Características:**

Velocidad: 25000rpm
 Entrada de aire: 1/4"
 Capacidad porta broca: 1/4"
 Diámetro manguera de aire: 3/8"
 Salida de aire: 1/4"

Presión aire recomendada: 90 PSI
 Consumo de aire: 4 CFM
 Presión sonora: LpA: 88,6 dB(A)
 KpA: 3 dB(A)
 Potencia sonora: LwA: 99,6 dB(A)
 KwA: 3 dB(A)

REF



9376

190mm



710gr



20x

 Mini lubrificador 1/4"

 Mini lubrificador 1/4"

 **Descrição:** Pressão máxima suportada: 10BAR (150psi)

 **Descripción:** Presión máxima soportada: 10BAR (150psi)

REF



2089

150gr



150x

 Encaixe rápido fêmea metálico

 Encaje rapido hembra metalico

 **Descrição:** Rosca 1/4" encaixe de ar fêmea 1/4"

 **Descripción:** Rosca de conexión de aire 1/4" hembra 1/4"

REF



2078

200gr



100x

 Encaixe rápido macho metálico

 Encaje rapido macho metalico

 **Descrição:** Rosca 1/4" encaixe de ar macho 1/4"

 **Descripción:** Rosca de conexión de aire macho 1/4"

REF



2079

100gr



100x

 Kit retificadora precisão pneumático - haste 3mm

 Kit amoladora precisión neumático 3mm

 **Especificações:**

Velocidade livre: 56.000 RPM
 Tamanho pinça: 1/8" (3 mm)
 Entrada de ar NPT: 1/4"
 Diâmetro interno mangueira: 6mm
 Consumo médio de ar: 1.5 CFM (42.5L/min)
 Pressão de ar recomendada: 90 PSI 6,2 BAR
 Comprimento: 140mm
 Pressão sonora: 83dB(A)
 Potência sonora: 94dB(A)

 **Especificaciones:**

Velocidad libre: 56.000 RPM
 Dimensiones pinza: 1/8" (3 mm)
 Entrada de aire NPT: 1/4"
 Diámetro interno manguera: 6mm
 Consumo medio de aire: 1.5 CFM (42.5L/min)
 Presión de aire recomendada: 90 PSI 6,2 BAR
 Longitud: 140mm
 Presión sonora: 83dB(A)
 Potencia sonora: 94dB(A)

REF



9285

132mm



600gr



10x

-  Kit retificadora precisão pneumático - haste 3mm
-  Kit amoladora precisión neumático 3mm



Especificações:
 Velocidade livre: 54.000 rpm
 Tamanho pinça: 1/8"
 Entrada de ar NPT: 1/4"
 Diâmetro interno mangueira: 3/8"
 Consumo médio de ar: 2.25 CFM
 Pressão de ar recomendada: 90 PSI
 Comprimento: 134mm
 Pressão sonora: LpA: 76 dB(A)
 Potência sonora: KpA: 87 dB(A)

Especificaciones:
 Velocidad libre: 54.000 rpm
 Dimensiones pinza: 1/8"
 Entrada de aire NPT: 1/4"
 Diámetro interno manguera: 3/8"
 Consumo medio de aire: 2.25 CFM
 Presión de aire recomendada: 90 PSI
 Longitud: 134mm
 Presión sonora: LpA: 76 dB(A)
 Potencia sonora: KpA: 87 dB(A)

REF	↔	📏	📦
9385	134mm	700gr	10x

-  Serra pneumática
-  Sierra neumática



Características:
 Capacidade de corte: 1,2 mm
 Golpes por minuto: 10.000 spm
 Entrada de ar: 1/4"
 Mangueira de ar: 3/8"
 Consumo de ar: 2,5 CFM
 Pressão de trabalho: 90 PSI
 Pressão sonora: LpA: 89 dB(A),
 LwA: 100 dB(A)
 Potência sonora: KpA: 3 dB(A),
 KwA: 3 dB(A)

Características:
 Capacidad de corte: 1,2 mm
 Golpes por minuto: 10.000 spm
 Entrada de aire: 1/4"
 Manguera de aire: 3/8"
 Consumo de aire: 2,5 CFM
 Presión de trabajo: 90 PSI
 Presión sonora: LpA: 89 dB(A),
 LwA: 100 dB(A)
 Potencia sonora: KpA: 3 dB(A),
 KwA: 3 dB(A)

REF	↔	📏	📦
9380	235mm	700gr	20x

-  Gravador de metal pneumático
-  Neumatica de grabado de aire



Características:
 Velocidade: 13.000 BPM (sem carga)
 Pressão de funcionamento: 90 PSI
 CFM Requisito: 0.25 CFM @ 90 PSI
 Entrada de ar: 1/4"-18 NPT
 Mangueira de ar (do compressor de ar): 3/8" (9,5 mm) (diâmetro interior)

Características:
 Velocidad: 13.000 BPM (sin carga)
 Presión de trabajo: 90 PSI
 CFM requeridos: 0.25 CFM @ 90 PSI
 Entrada de aire: 1/4"-18 NPT
 Manguera de aire (del compresor de aire): 3/8" (9,5 mm) (diámetro interior)

REF	📏	📦
9384	300gr	10x

-  Máquina cortar vidro pneumática
 Máquina desmontar lunas pneumática



 **Características:**
 Oscilação: 20,000 RPM
 Distância de corte: 3"
 Entrada de ar: 1/4"
 Mangueira de ar: 3/8" (diâmetro interior)

Consumo médio de ar: 6 SCFM
 Pressão de trabalho: 90 PSI (6.3 BAR)
 Pressão sonora: LpA: 85 dB(A),
 LwA: 96 dB(A)
 Potência sonora: KpA: 3 dB(A),
 KwA: 3 dB(A)

 **Características:**
 Oscilación: 20.000 RPM
 Distancia de corte: 3"
 Entrada de aire: 1/4"
 Manguera de aire: 3/8" (diámetro interior)

Consumo medio de aire: 6 SCFM
 Presión de trabajo: 90 PSI (6,3 BAR)
 Presión sonora: LpA: 85 dB(A),
 LwA: 96 dB(A)
 Potencia sonora: KpA: 3 dB(A),
 KwA: 3 dB(A)

REF



9387

257mm



1,1kg



10x

-  Máquina pneumática para foles
 Instalador neumático para fuelles



 AVISO: A máquina têm que estar sempre ligada a mangueira de ar para trabalhar.
 ADVERTENCIA: La máquina siempre debe estar conectada a la manguera de aire para funcionar.

 **Características:**
 Pressão trabalho: 4-8BAR
 Diâmetro abertura máxima com fole: 100mm
 Entrada de ar: 1/4"

 **Características:**
 Presión trabajo: 4-8BAR
 Diámetro máximo de apertura con fuelle: 100mm
 Entrada de aire: 1/4"

REF



5510

100mm



465mm



2,3kg



6x

-  Cone de montagem de foles
 Cono para fuelle de cardán



 **Descrição:**
 Esta ferramenta permite ao utilizador trocar o fole sem desmontar a transmissão

Medidas:
 Cone afunilado: 34-101mm
 Comprimento cone: 320mm
 Comprimento total: 405mm

Características:
 Cone feito de material resistente e fácil de limpar
 Barra central de aço com furo de 6mm (15,8×15,8×85mm) que pode ser usada para puxar o fole sobre o eixo de transmissão

 **Descripción:**
 Esta herramienta permite cambiar los fuelles sin desmontar la transmisión

Medidas:
 Cono cónico: 34-101mm
 Longitud del cono: 320mm
 Longitud total: 405mm

Características:
 Cono de material resistente y fácil de limpiar
 Barra central de acero con orificio de 6mm (15,8×15,8×85mm) que se puede utilizar para tirar del fuelle sobre el eje de transmisión

REF



5511

550gr



20x

 Kit martelo pneumático 13 peças
 Kit martillo neumático 13 piezas



 **Composição:**
(1x) Martelo grande plano 74mm
(1x) Martelo côncavo grande 63mm
(1x) Martelo Plano Médio 38mm
(1x) Adaptador 1/2" martelo
(1x) Eixo adaptador martelo
(1x) Martelo de 25mm
(1x) Martelo de haste
(1x) Separador rótulas impacto 7" x 24mm
(1x) Separador rótulas impacto 7" x 20mm
(1x) Cinzel plano de 20mm
(1x) Ponta cinzel
(1x) Martelo de alisamento 38,5mm diâmetro
(1x) Martelo pneumático
Características:
Pressão sonora: 94dB(A)
Potência sonora: 105dB(A)

 **Composición:**
(1x) Martillo gran plan 74mm
(1x) Martillo côncavo grande de 63mm
(1x) Martillo plano mediano de 38mm
(1x) Adaptador de martillo de 1/2"
(1x) Eje adaptador de martillo
(1x) Martillo de 25mm
(1x) Martillo de varilla
(1x) Separador de rótula de impacto de 7" x 24 mm
(1x) Separador de rótula de impacto de 7" x 20 mm
(1x) Cincel plano de 20mm
(1x) Punta de cincel
(1x) Martillo enderezador de 38,5mm diámetro
(1x) Martillo neumático
Características:
Presión sonora: 94dB(A)
Potencia sonora: 105dB(A)

REF		
9283	6kg	2x

 Kit mini lixadora e polidora disco 75mm
 Kit mini lijadora y pulidora disco 75mm



Lixa / Lija 320  REF 9260L32	Lixa / Lija 400  REF 9260L40	Lixa / Lija 600  REF 9260L60
Lixa / Lija 2000  REF 9260L20	Lixa / Lija 2500  REF 9260L25	Lixa / Lija 3000  REF 9260L30
Prato / Plato 75mm  REF 9260PV	Esponja  REF 9260E	Boina / Funda  REF 9260B

 **Características:**
Velocidade: 2500rpm
Diâmetro disco: 75mm
Fuso rosca: 1/4"-20 ou M6x1.0
Entrada de ar: 1/4"
Diâmetro mangueira: 3/8"
Consumo de ar: 91L/min
Pressão de ar: 90psi (6.2 bar)
Pressão sonora: 83dB(A)
Potência sonora: 94dB(A)

 **Características:**
Velocidad: 2500rpm
Diámetro disco: 75mm
Hilo rosca: 1/4"-20 o M6x1.0
Entrada de aire: 1/4"
Diámetro manguera: 3/8"
Consumo de aire: 91L/min
Presión de aire: 90psi (6.2 bar)
Presión sonora: 83dB(A)
Potencia sonora: 94dB(A)

REF		
9260	75mm	5x

 Lixadora orbital
 Lijadora roto orbital

**Características:**

Velocidade: 12000rpm
 Diâmetro orbita: 5mm
 Diâmetro disco: 150mm
 Fuso rosca: 5/16"-24
 Entrada de ar: 1/4"

Diâmetro mangueira: 3/8"
 Consumo de ar: 57L/min
 Pressão sonora: 76dB(A)
 Potência sonora: 87dB(A)

Características:

Velocidade: 12000rpm
 Diâmetro orbita: 5mm
 Diâmetro disco: 150mm
 Hilo de rosca: 5/16"-24
 Entrada de aire: 1/4"

Diâmetro mangueira: 3/8"
 Consumo de aire: 57L/min
 Presión sonora: 76dB(A)
 Potencia sonora: 87dB(A)

REF



9250

150mm

187mm

1,1kg

10x

 Lixadora orbital 150mm - 2.5mm orbita
 Lijadora orbital 150mm - 2.5mm orbita

**Características:**

Velocidade: 12000rpm
 Diâmetro orbita: 2.5mm
 Diâmetro disco: 150mm
 Entrada de ar: 1/4"
 Diâmetro mangueira: 3/8"

Pressão funcionamento: 90psi
 (6.3BAR)
 Consumo de ar: 128L/min
 Pressão sonora: 89,5dB(A)
 Potência sonora: 100,5dB(A)

Características:

Velocidade: 12000rpm
 Diâmetro de la órbita: 2.5mm
 Diámetro del disco: 150mm
 Entrada de aire: 1/4"
 Diámetro mangueira: 3/8"

Presión de trabajo: 90psi (6.3BAR)
 Consumo de aire: 128L/min
 Presión sonora: 89,5dB(A)
 Potencia sonora: 100,5dB(A)

REF



9265

150mm

1,4kg

10x

 Lixadora orbital 150mm - 5mm orbita
 Lijadora orbital 150mm - 5mm orbita

**Características:**

Velocidade: 12.000rpm
 Diâmetro orbita: 5mm
 Diâmetro disco: 150mm
 Entrada de ar: 1/4"
 Diâmetro mangueira: 3/8"

Pressão funcionamento: 90psi
 (6.3bar)
 Consumo de ar: 128L/min
 Pressão sonora: LpA= 89.5dB(A)
 Potência sonora: LwA=100.5dB(A)

Características:

Velocidade: 12.000rpm
 Diâmetro de la órbita: 5mm
 Diámetro del disco: 150mm
 Entrada de aire: 1/4"
 Diámetro mangueira: 3/8"

Presión de trabajo: 90psi (6.3bar)
 Consumo de aire: 128L/min
 Presión sonora: LpA= 89.5dB(A)
 Potencia sonora: LwA=100.5dB(A)

REF



9266

150mm

1,6kg

10x

 Pistola tornado
 Pistola tornado

**Características:**

Velocidade: 4000-8000rpm
 Ruído: 95dB
 Entrada de ar: 1/4"
 Consumo de ar: 160L/min
 Consumo máx. água: 110cc/m
 Pressão funcionamento: 3.5/50 BAR/PSI 8/115 BAR/PSI

Características:

Velocidad: 4000-8000rpm
 Ruido: 95dB
 Entrada de aire: 1/4"
 Consumo de aire: 160L/min
 Consumo máx. agua: 110cc/m
 Presión funcionamiento: 3.5/50 BAR/PSI, 8/115 BAR/PSI

REF



2094

1kg

10x

 Pistola tornado
 Pistola tornado



 **Características:**
Dimensões: 280x125x220mm
Pressão: 6-9.2kg
Temperatura: 10~5CTC
Escova: PVC

 **Características:**
Dimensiones: 280x125x220mm
Presión: 6-9.2kg
Temperatura: 10~5CTC
Cepillo: PVC

<p><i>Pistola</i></p>  <p>REF 2096-01</p>	<p><i>Corpo / Cuerpo</i></p>  <p>REF 2096-02</p>	<p><i>Bocal / Boquilla</i></p>  <p>REF 2096-03</p>
<p><i>Guia Teflon</i></p>  <p>REF 2096-04</p>	<p><i>Copo / Copa</i></p>  <p>REF 2096-05</p>	<p><i>Tampa / Tapa</i></p>  <p>REF 2096-06</p>
<p><i>Passador / Válvula</i></p>  <p>REF 2096-07</p>	<p><i>Bicone / Bicono</i></p>  <p>REF 2096-08</p>	<p><i>Tu. sucção / Tu. Succión</i></p>  <p>REF 2096-09</p>
<p><i>União / Conexão</i></p>  <p>REF 2096-10</p>		

REF

2096



833gr



12x

 Pistola espuma
 Pistola de espuma



 **Características:**
Tamanho: 130x260x260mm
Pressão: 0.6~0.92 mpa
Capacidade: 1000ml
Líquido: neutro
Temperatura: 10~40°C

Atenção:
O compressor de ar deve ser de 0.6~0.92 mpa
Pressão deve se manter nos 0.8 mpa
O líquido deve ser neutro
Não deve utilizar solventes

 **Características:**
Tamaño: 130x260x260mm
Presión: 0.6~0.92 mpa
Capacidad: 1000ml
Líquido: neutro
Temperatura: 10~40°C

Atención:
El compresor de aire debe ser 0.6~0.92 mpa
La presión debe permanecer en 0.8 mpa
El líquido debe ser neutro
No utilice disolventes

REF

2098



900gr



10x

 Pistola de limpeza para motores
 Pistola de limpieza de motor



 **Características:**
Tamanho: 420x226x130mm
Pressão: 0.6~0.92 mpa
Capacidade: 1000ml
Líquido: neutro
Temperatura: 10~50°C

Atenção:
O compressor de ar deve ser de 0.6~0.92 mpa
Pressão deve se manter nos 0.8 mpa
O líquido deve ser neutro
Não deve utilizar solventes

 **Características:**
Tamaño: 420x226x130mm
Presión: 0.6~0.92 Mpa
Capacidad: 1000ml
Líquido: neutro
Temperatura: 10~50°C

Atención:
El compresor de aire debe ser 0.6~0.92 mpa
La presión debe permanecer en 0.8 mpa
El líquido debe ser neutro
No utilice disolventes

REF

2099



500gr



20x

-  Pistola parafinar com bico flexível
 Pistola parafinar con punta flexible



-  **Características:**
 Para detergentes e solventes
 Consumo de ar: 113L/min
 Entrada de ar: 1/4"
 Pressão de ar recomendada: 90psi (6.2BAR)

-  **Características:**
 Para detergentes y disolventes
 Consumo de aire: 113L/min
 Entrada de aire: 1/4"
 Presión de aire recomendada: 90psi (6.2BAR)

REF			
2092	1L	600gr	20x

-  Pistola lavagem pneumática para sistema de refrigeração
 Pistola neumática para lavado del sistema de refrigeración



-  **Características:**
 5 tamanhos de adaptador: Ø19, Ø29, Ø32, Ø36.5, Ø40mm
 Pressão de operação: 90psi
 Ruído: 85dB

-  **Características:**
 5 tamaños de adaptador: Ø19, Ø29, Ø32, Ø36.5, Ø40mm
 Presión de funcionamiento: 90psi
 Ruido: 85dB

REF		
2097	300gr	20x

-  Pistola de silicone pneumática
 Pistola de silicona neumática



-  **Características:**
 Entrada de ar: 1/4"
 Consumo de ar: 113L/min
 Diâmetro mangueira: 3/8"
 Funcionamento pressão de ar: 50-70psi
 Pressão sonora: 102dB(A)
 Potência sonora: 113dB(A)

-  **Características:**
 Entrada de aire: 1/4"
 Consumo de aire: 113L/min
 Diámetro manguera: 3/8"
 Funcionamiento presión de aire: 50-70psi
 Presión sonora: 102dB(A)
 Potencia sonora: 113dB(A)

REF			
2299	305mm	1,25kg	10x

-  Pistola soprar 100mm
 Pistola soplar 100mm



-  **Características:**
 Comprimento total: 230mm
 Comprimento bico: 100mm

-  **Características:**
 Longitud total: 230mm
 Longitud punta: 100mm

REF			
2090	230mm	145gr	100x

 Pistola soprar 250mm
 Pistola soplar 250mm



 **Características:**
Comprimento total: 390mm
Comprimento bico: 250mm

 **Características:**
Longitud total: 390mm
Longitud punta: 250mm

REF	↔	📏	📦
2093	390mm	195gr	100x

 Tubo espiral de poliuretano
 Manguera en espiral de poliuretano



Rosca engate 1/4"
(2081,2082,2083)
Rosca acoplamiento 1/4"
(2081,2082,2083)



REF 2082-01

Rosca engate 3/8" (2086)
Rosca acoplamiento 3/8" (2086)



REF 2086-01

 **Características:** Rosca engate 1/4" (2081,2082,2083); Rosca engate 3/8" (2086)

 **Características:** Rosca acoplamiento 1/4" (2081,2082,2083); Rosca acoplamiento 3/8" (2086)

REF	⊕	↔	📏	📦
2081	6.5x9.5mm	15m	800gr	10x
2082	8x12mm	10m	910gr	10x
2083	8x12mm	15m	1,2kg	10x
2086	12x16mm	15m	1,96kg	10x

 Macaco balão pneumático 3T
 Gato de globo neumático 3T



 **Características:**
Capacidade: 3T
Altura mínima: 145mm
Altura máxima: 400mm
Pressão: 8-12 BAR

 **Características:**
Capacidad: 3T
Altura mínima: 145 mm
Altura máxima: 400 mm
Presión: 8-12 BAR

REF	📏	📦
4851	16,1kg	1x



Máquina de nitrogénio para pneus
Generador nitrogeno para neumáticos

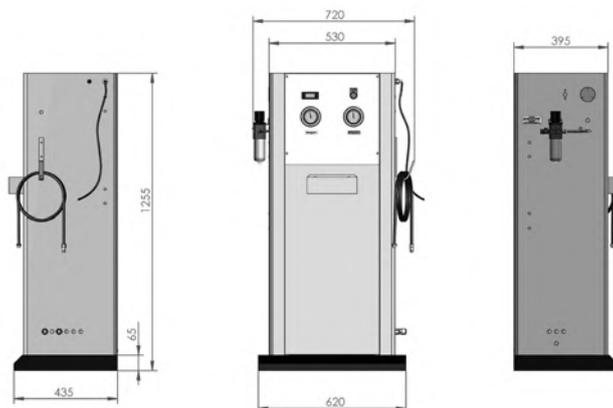

 **Características:**

Energia: 100-240V 50/60hz
 Intervalo entrada de ar: 87-123PSI/ 6-8.5Bar
 Qualidade ar comprimido: 0.01ppm
 Pressão recomendada entrada de ar: 44psi, 300kpa ou 3Bar
 Pureza nitrogénio: 95-99%
 Saída nitrogénio: 42L/min (1.5CFM) 116psi
 Pressão máxima de nitrogénio no tanque: 102psi
 Intervalo de funcionamento: 5-90psi

 **Características:**

Energia: 100-240V 50/60hz
 Rango entrada de aire: 87-123PSI/ 6-8.5Bar
 Calidad aire comprimido: 0.01ppm
 Presión recomendada entrada de aire: 44psi, 300kpa o 3Bar
 Pureza nitrogeno: 95-99%
 Salida nitrogeno: 42L/min (1.5CFM) 116psi
 Presión máxima de nitrógeno en el tanque: 102psi
 Rango de funcionamiento: 5-90psi

REF

9500



42L/min



84kg



1x



Máquina nitrogénio pneus pesados 145PSI/10BAR
Generador de nitrógeno para neumáticos pesados 145PSI/10BAR

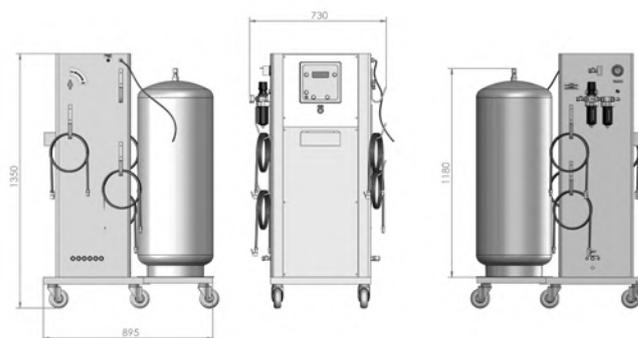

 **Características:**

Requisitos de energia: 100/240V AC 50/60Hz
 Temperatura de operação: -20°C a 70°C, -4°F a 158°F
 Faixa de entrada de ar comprimido: 145-217psi / 1000-1500kPa / 10-15BAR
 Qualidade do ar comprimido: 0,01 ppm
 Pressão de alimentação de entrada recomendada: 44 psi, 300kPa ou 3BAR acima da pressão máxima de ajuste da unidade
 Pureza do nitrogénio: 95-99 +%, ajustável
 Saída de nitrogénio: 228L / min (8CFM) @ 116psi / 800kPa / 8BAR de pressão de absorção
 Pressão máxima de nitrogénio no tanque: 145-174psi / 1000-1200kPa / 10-12BAR
 Faixa de operação: 5-162 psi / 35-1120 kPa / 0,3-11,2 BAR
 Precisão: +/- 1 psi, 7 kPa, 0,07 BAR
 Incrementos de exibição: 1 psi, 5 kPa, 0,1 BAR
 Unidades de medida: psi, kPa, BAR

 **Características:**

Potencia requerida: 100/240V AC 50/60Hz
 Temperatura de funcionamiento: -20°C a 70°C, -4°F a 158°F;
 Rango de entrada de aire comprimido: 145-217psi / 1000-1500kPa / 10-15BAR
 Calidad del aire comprimido: 0,01 ppm
 Presión de suministro de entrada recomendada: 44 psi, 300kPa o 3 BAR por encima de la presión de ajuste máxima de la unidad
 Pureza del nitrógeno: 95-99 +%, ajustable
 Salida de nitrógeno: 228L / min (8CFM) @ 116psi / 800kPa / 8BAR de presión de absorción
 Presión máxima del tanque de nitrógeno: 145-174psi / 1000-1200kPa / 10-12BAR
 Rango de funcionamiento: 5-162 psi / 35-1120 kPa / 0,3-11,2 BAR;
 Precisión: +/- 1 psi, 7 kPa, 0,07 BAR
 Incrementos de la pantalla: 1 psi, 5 kPa, 0,1 BAR
 Unidades de medida: psi, kPa, BAR

REF

9503



228L/min



223kg



1x

FERRAMENTA HIDRÁULICA HERRAMIENTA HIDRÁULICA

11



 FAMÍLIA	PÁGINAS
01 FERRAMENTA MANUAL	11-106
02 ALICATES	109-120
03 BITS E CONJUNTOS	123-134
04 FERRAMENTA ESPECÍFICA	137-214
05 FERRAMENTA CARROÇARIA	217-222
06 REGULAÇÃO E TESTE	225-246
07 FERRAMENTA MOTOR	249-276
08 KITS SINCRONIZAÇÃO	279-350
09 FERRAMENTA ELÉTRICA	353-362
10 FERRAMENTA PNEUMÁTICA	365-378
11 FERRAMENTA HIDRÁULICA	381-404
12 FERRAMENTA LUBRIFICAÇÃO	407-414
13 EQUIPAMENTO GARAGEM	417-502
RT ROUPA DE TRABALHO	505-508
MR MERCHANDISING	511-514
EP EXPOSITORES	517-524
LR LOCALIZAÇÃO REFERÊNCIAS	527-538

 FAMILIA	PÁGINAS
01 HERRAMIENTA MANUAL	11-106
02 ALICATES	109-120
03 PUNTAS Y CONJUNTOS	123-134
04 HERRAMIENTA ESPECÍFICA	137-214
05 HERRAMIENTA DE CARROCERIA	217-222
06 REGULACIÓN Y PRUEBAS	225-246
07 HERRAMIENTA PARA MOTOR	249-276
08 KIT CALADO	279-350
09 HERRAMIENTA ELÉCTRICA	353-362
10 HERRAMIENTA NEUMÁTICA	365-378
11 HERRAMIENTA HIDRÁULICA	381-404
12 HERRAMIENTA LUBRICACIÓN	407-414
13 EQUIPAMENTO PARA TALLER	417-502
RT ROPA DE TRABAJO	505-508
MR MERCHANDISING	511-514
EP EXPOSITORES	517-524
LR LOCALIZACIÓN REFERENCIAS	527-538



Macaco rodas 2.5T
Gato ruedas 2.5T

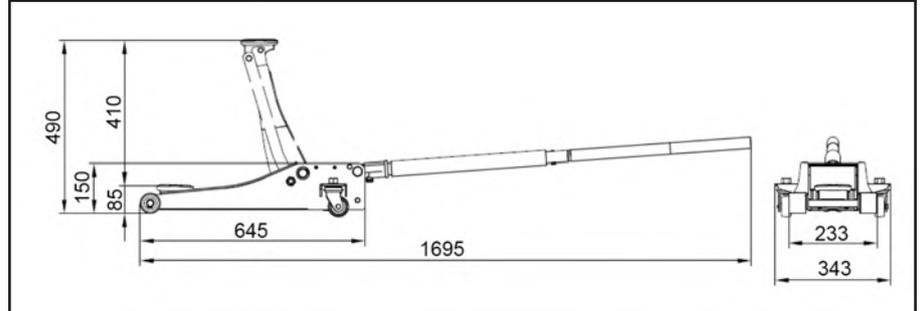

Características:
Altura mínima: 85mm
Altura máxima: 490mm
Curso: 405mm
Com LOGOTIPO na base de borracha
Roda em nylon

Características:
Altura mínima: 85mm
Altura máxima: 490mm
Carrera: 405mm
Con LOGO en la base de goma
Rueda de nylon

REF			
4940	2,5T	28,5kg	1x

Macaco de rodas 2T rebaixado
Gato de ruedas 2T bajo perfil

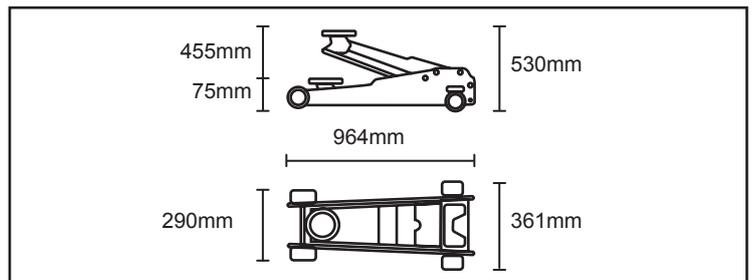

Características:
Altura mínima: 75mm
Altura máxima: 530mm
Diâmetro externo rodas traseiras: 63mm, frontais: 60mm

Características:
Altura mínima: 75mm
Altura máxima: 530mm
Diámetro exterior ruedas traseras: 63mm, delantera: 60mm

REF			
4813	2T	42,2kg	1x

-  Macaco rodas 3Ton rebaixado e velocidade aproximação
 Gato de rueda de 3 toneladas rebajado y velocidad de aproximación

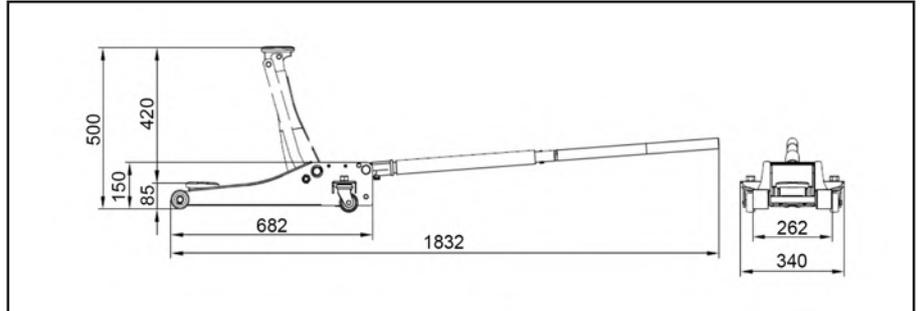

-  **Características:**
 Altura mínima: 85mm
 Altura máxima: 500mm

-  **Características:**
 Altura mínima: 85mm
 Altura máxima: 500mm

REF

4804



3T



26,8kg



1x

-  Macaco rodas p/ transmissão 1Ton
 Gato de ruedas para transmision 1Ton



-  **Características:**
 Altura mínima: 190mm
 Altura máxima: 770mm
 Ajuste Lateral E/D: 10° / 15°
 Dimensão do Apoio: 200 x 180 mm
 Dimensão da Base (C x L): 675 x 577mm

-  **Características:**
 Altura mínima: 190mm
 Altura máxima: 770mm
 Ajuste Lateral E/D: 10° / 15°
 Tamaño de la silla: 200 x 180 mm
 Tamaño de la base (L x A): 675 x 577mm

REF

4926



1T



133kg



1x

Macaco rodas 2T low profile
Gato ruedas 2T low profile

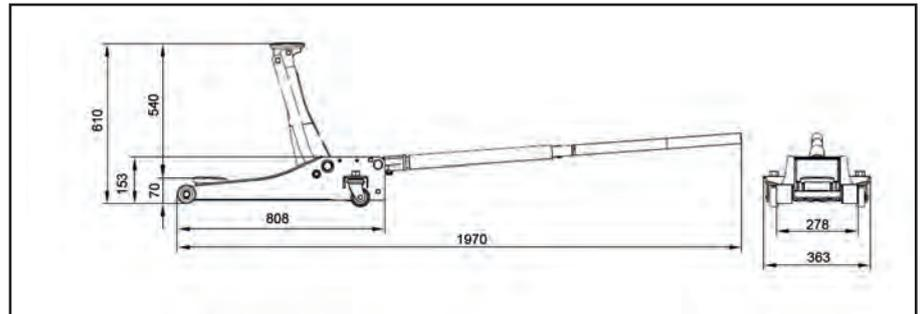

Características:
Altura mínima: 70mm
Altura máxima: 610mm

Características:
Altura mínima: 70mm
Altura máxima: 610mm

REF			
4942	2T	43,8kg	1x

Macaco Hidro-Pneumático rodas 10Ton - Chassi Longo
Gato de ruedas 10Ton

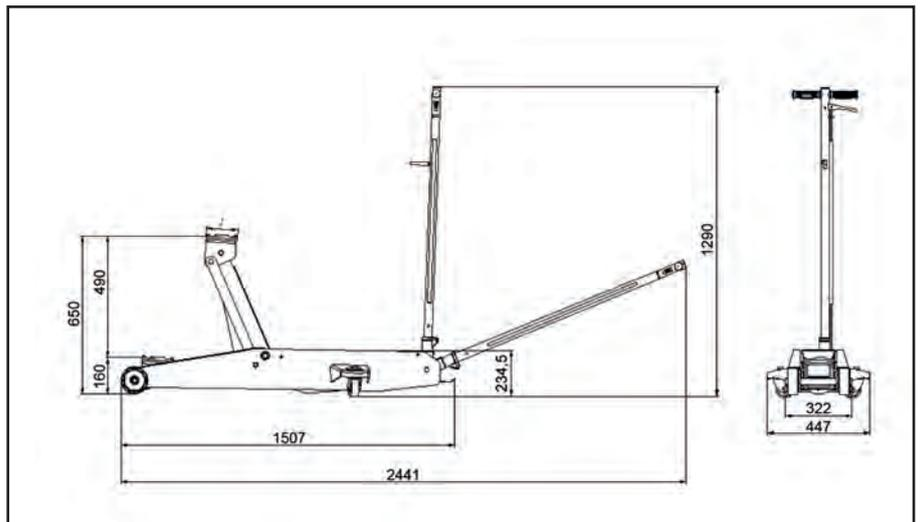

Características:
Altura mínima: 160mm
Altura máxima: 650mm

Características:
Altura mínima: 160mm
Altura máxima: 650mm

REF			
4908	10T	116kg	1x

Macaco de rodas 5T
Gato de ruedas 5T

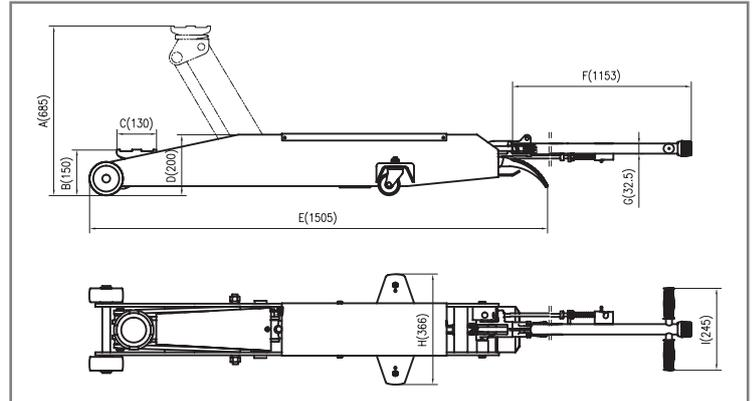

Características:
Altura mínima: 150mm
Altura máxima: 685mm

Características:
Altura mínima: 150mm
Altura máxima: 685mm

REF			
4906	5T	89kg	1x

Macaco de rodas 10T
Gato de ruedas 10T

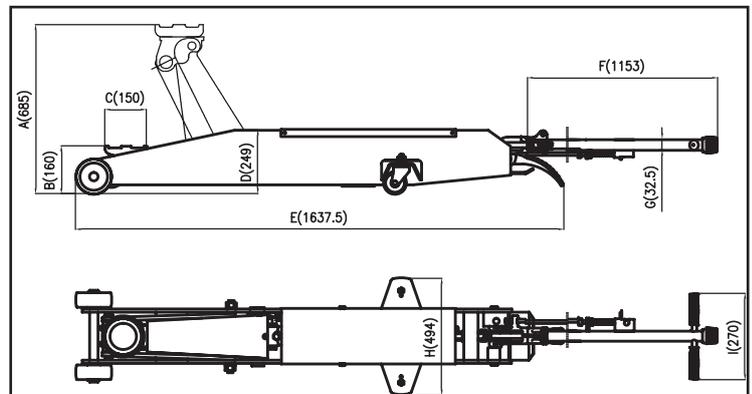

Características:
Altura mínima: 160mm
Altura máxima: 685mm

Características:
Altura mínima: 160mm
Altura máxima: 685mm

REF			
4907	10T	133kg	1x

 Adaptador transversal 2T p/macaco de rodas
 Soporte transversal 2T para gato hidráulico



 **Características:**
Comprimento do produto faixa de ajuste: 710-940mm
Comprimento da corrente de segurança: 235mm
Tamanho da base de borracha: 120*120mm
Largura total do produto: 127mm
Altura total do produto: 127mm

 **Características:**
Longitud del producto rango de ajuste: 710-940mm
Longitud de la cadena de seguridad: 235mm
Tamaño de la almohadilla de goma: 120*120mm
Anchura total del producto: 127mm
Altura total del producto: 127mm

REF			
4932	2T	10kg	1x

 Macaco hidráulico 2T rebaixado
 Gato hidráulico bajo perfil 2Ton

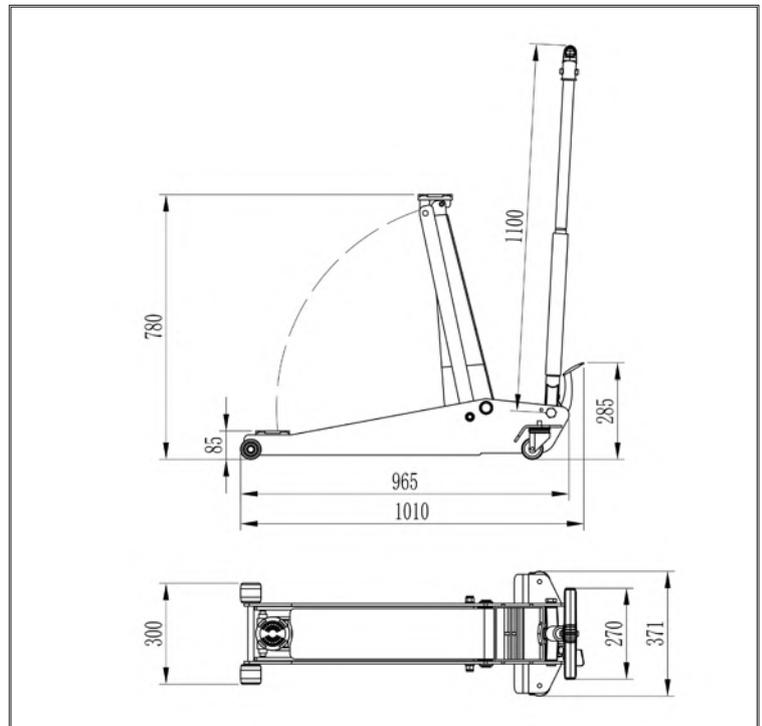

 **Características:**
Altura mínima: 85mm
Altura máxima: 780mm

 **Características:**
Altura mínima: 85mm
Altura máxima: 780mm

REF			
4814	2T	54,18kg	1x

Macaco hidráulico pneumático 15-30T

Gato hidráulico pneumático 15-30T

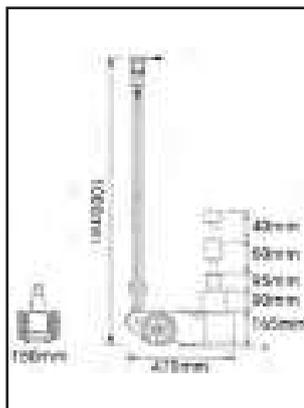

Características:

Pressão de ar: 0.8-1.2 Mpa
 Intervalo elevação: 165-340mm
 Aumentos: 40/60mm
 Diâmetro cilindros: 120mm

Características:

Presión de aire: 0.8-1.2 Mpa
 Intervalo de elevación: 165-340mm
 Alargaderas: 40/60mm
 Diámetro cilindros: 120mm

REF

4822



15-30T



32,5kg



1x

Macaco hidráulico pneumático 25-50T

Gato hidráulico pneumático 25-50T

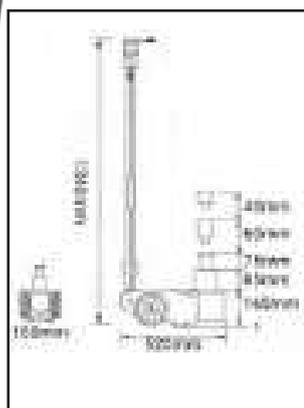

Características:

Pressão de ar: 0.8-1.2 Mpa
 Intervalo elevação: 165-330mm
 Aumentos: 40/60mm
 Diâmetro cilindro: 136mm

Características:

Presión de aire: 0.8-1.2 Mpa
 Intervalo de elevación: 165-330mm
 Alargaderas: 40/60mm
 Diámetro cilindro: 136mm

REF

4823



25-50T



38,5kg



1x

Macaco hidráulico pneumático 40-80T

Gato hidráulico pneumático 40-80T

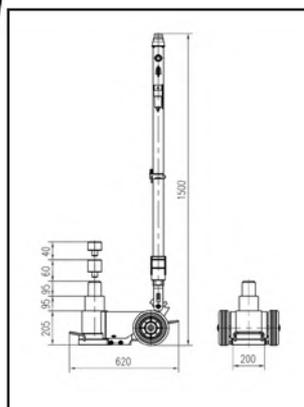

Características:

Altura mínima: 205mm
 Altura máxima: 395mm
 Altura de elevação: 190mm
 Pressão do ar: 0.8-1.2 Mpa
 Sistema de prolongamento: 40/60mm

Características:

Altura mínima: 205mm
 Altura máxima: 395mm
 Altura de elevación: 190mm
 Presión de aire: 0.8-1.2 Mpa
 Sistema de extensión: 40/60mm

REF

4824



40-80T



38,5kg



1x

 Adaptador borracha de macaco para Tesla Model X/S/3
 Adaptador goma de gato para Tesla Model X/S/3



 **Descrição:**
Tamanho: 75x50mm
Basta inserir a ferramenta no orifício do macaco
Evite danificar a bateria e a saia lateral
Aplicação:
Adequado para todos os modelos Tesla X / S / 3

 **Descripción:**
Tamaño: 75x50mm
Simplemente inserte la herramienta en el orificio del gato
Evite dañar la batería y el faldón lateral
Aplicación:
Apto para todos los modelos Tesla X / S / 3

REF

4915



150gr



100x

 Macaco hidráulico neumático 15-30T curto
 Gato hidráulico neumático 15-30T (corto)

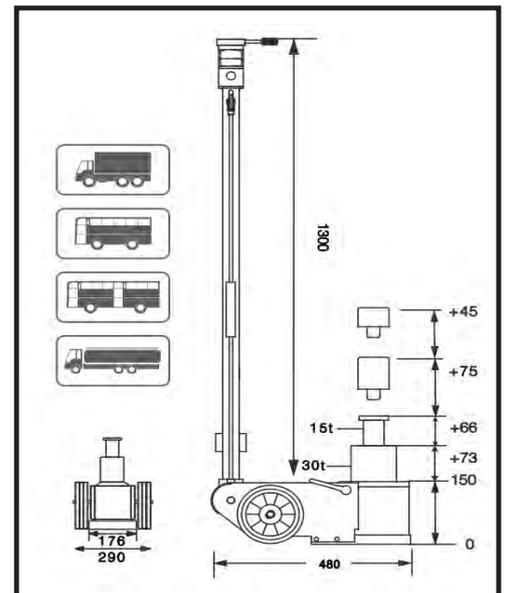

 **Características:**
Litros de óleo recomendado: 0.90 L
Pressão funcionamento: 0.9-1.2Mpa
Altura mínima: 150mm
Altura máxima: 409mm
Altura 30T: 73mm
Altura 15T: 66mm
Extensões: 75mm e 45mm

 **Características:**
Capacidad aceite: 0.9L
Presión funcionamiento: 0.9-1.2Mpa
Altura mínima: 150mm
Altura máxima: 409mm
Altura 30T: 73mm
Altura 15T: 66mm
Extensiones: 75mm y 45mm

REF

4816



15-30T



34kg



1x

 Macaco hidráulico pneumático 20-40T curto

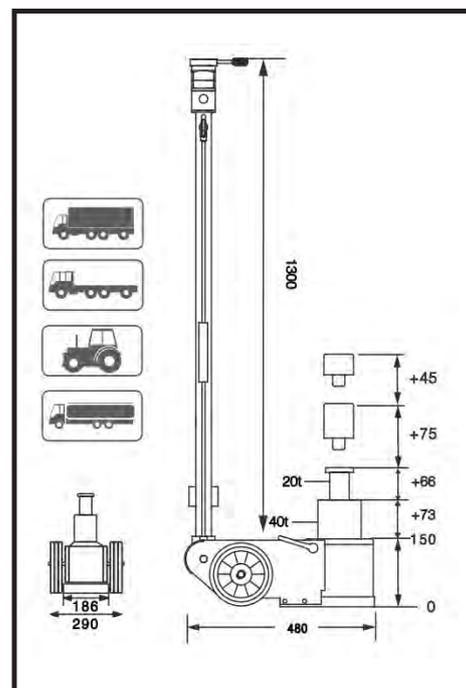
 Gato hidráulico neumático 20-40T (corto)

 **Características:**

Capacidade óleo: 1L
 Pressão funcionamento: 0.9-1.2Mpa
 Altura mínima: 150mm
 Altura máxima: 409mm
 Altura 40T: 73mm
 Altura 20T: 66mm
 Extensões: 75mm e 45mm

 **Características:**

Capacidad aceite: 1L
 Presión funcionamiento: 0.9-1.2Mpa
 Altura mínima: 150mm
 Altura máxima: 409mm
 Altura 40T: 73mm
 Altura 20T: 66mm
 Extensiones: 75mm y 45mm

REF

4817



20-40T



36kg



1x

 Macaco hidráulico pneumático 20-40T

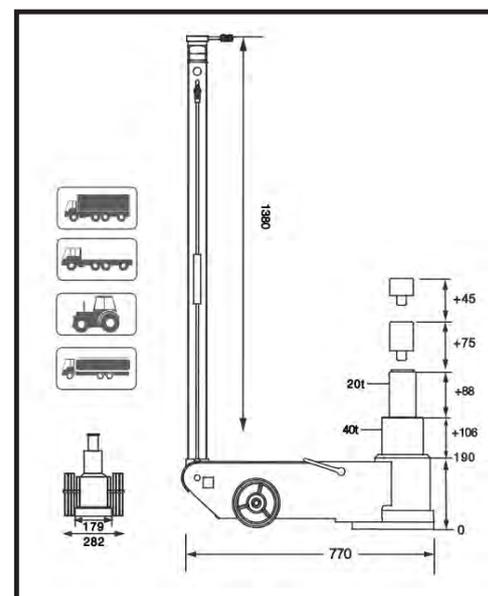
 Gato hidráulico neumático 20-40T

 **Características:**

Capacidade óleo: 2,8L
 Pressão funcionamento: 0.9-1.2Mpa
 Altura mínima: 190mm
 Altura máxima: 504mm
 Altura 40T: 106mm
 Altura 20T: 88mm
 Extensões: 75mm e 45mm

 **Características:**

Capacidad aceite: 2,8L
 Prensa de funcionamiento: 0.9-1.2Mpa
 Altura mínima: 190mm
 Altura máxima: 504mm
 Altura 40T: 106mm
 Altura 20T: 88mm
 Extensiones: 75mm y 45mm

REF

4818



20-40T



58,7kg



1x

Macaco hidráulico pneumático 10-20-40T
Gato hidráulico neumático 10-20-40T

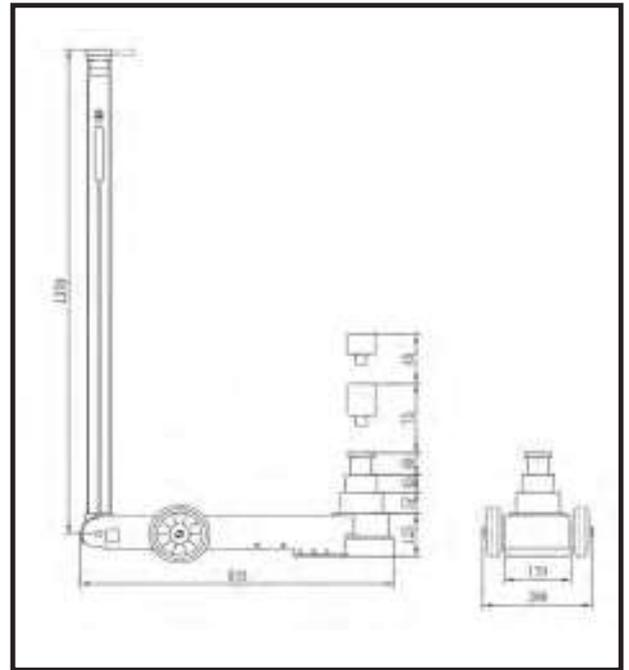

Características:
Capacidade óleo: 2,5L
Pressão funcionamento: 0.9-1.2Mpa
Altura mínima: 125mm
Altura máxima: 396mm
Altura 40T: 57mm
Altura 20T: 45mm
Altura 10T: 49mm
Extensões: 75mm e 45mm

Características:
Capacidad aceite: 2,5L
Presión funcionamiento: 0.9-1.2Mpa
Altura mínima: 125mm
Altura máxima: 396mm
Altura 40T: 57mm
Altura 20T: 45mm
Altura 10T: 49mm
Extensiones: 75mm y 45mm

REF			
4812	10-20-40T	45kg	1x

Aumentos macacos pneumáticos
Amplificadores gatos neumáticos



Características: Diâmetro encaixe: 30mm

Características: Diámetro enchufe: 30mm

REF			
481603	45mm	300gr	1x
481604	75mm	450gr	50x

Macaco de garrafa 2T
Gato de botella 2T

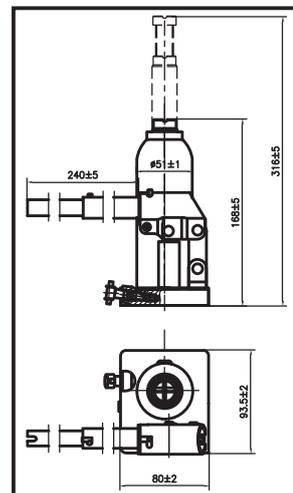

Características:
Altura mínima: 168mm
Altura máxima: 316mm
Tamanho da base: 93.5x980mm

Características:
Altura mínima: 168mm
Altura máxima: 316mm
Tamaño de la base: 93.5x980mm

REF			
4702	2T	2,4kg	6x

Macaco de garrafa 3T
 Gato de botella 3T

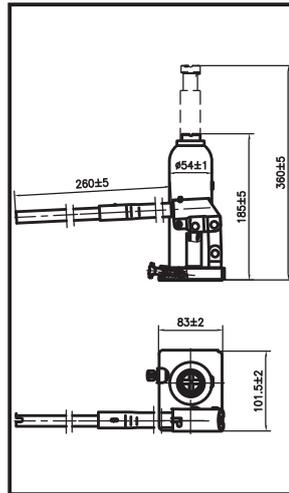

Características:
 Altura mínima: 185mm
 Altura máxima: 360mm,
 Tamanho da base: 104x90mm

Características:
 Altura mínima: 185mm
 Altura máxima: 360mm,
 Tamaño de la base: 104x90mm

REF

4703



3T



3,1kg



6x

Macaco de garrafa 5T
 Gato de botella 5T

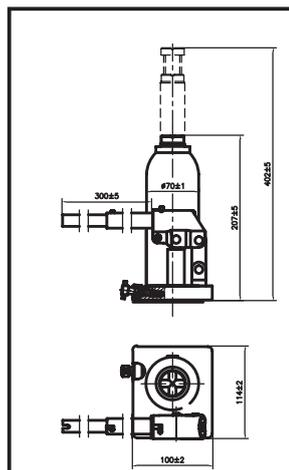

Características:
 Altura mínima: 207mm
 Altura máxima: 402mm
 Tamanho da base: 114x100mm

Características:
 Altura mínima: 207mm
 Altura máxima: 402mm
 Tamaño de la base: 114x100mm

REF

4705



5T



4,1kg



4x

Macaco de garrafa 10T
 Gato de botella 10T

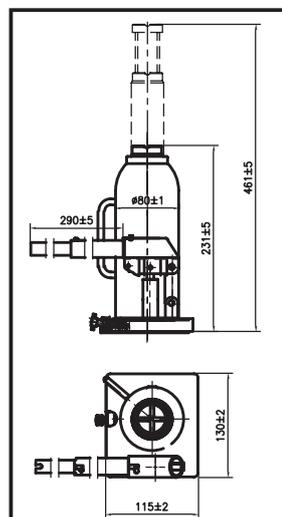

Características:
 Altura mínima: 231mm
 Altura máxima: 461mm
 Tamanho da base: 130x115mm

Características:
 Altura mínima: 231mm
 Altura máxima: 461mm
 Tamaño de la base: 130x115mm

REF

4710



10T



5,9kg



4x

Macaco de garrafa 12T
Gato de botella 12T

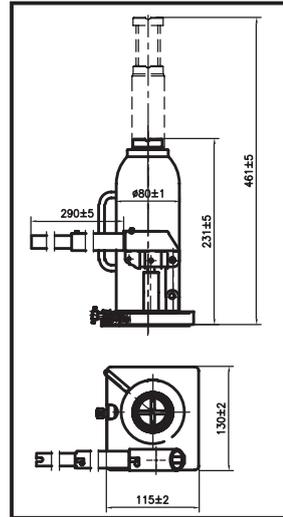

Características:
Altura mínima: 231mm
Altura máxima: 441mm
Tamaño da base: 135x115mm

Características:
Altura mínima: 231mm
Altura máxima: 441mm
Tamaño de la base: 135x115mm

REF



4712

12T

6,4kg

4x

Macaco de garrafa 16T
Gato de botella 16T

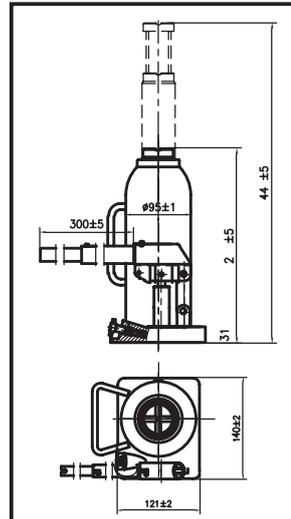

Características:
Altura mínima: 231mm
Altura máxima: 441mm
Tamaño da base: 140x120mm

Características:
Altura mínima: 231mm
Altura máxima: 441mm
Tamaño de la base: 140x120mm

REF



4716

16T

7,4kg

2x

Macaco de garrafa 20T
Gato de botella 20T

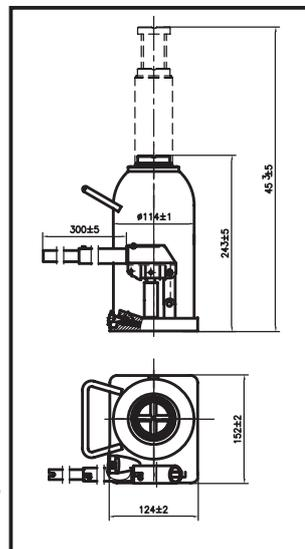

Características:
Altura mínima: 243mm
Altura máxima: 453mm
Tamaño da base: 152x124mm

Características:
Altura mínima: 243mm
Altura máxima: 453mm
Tamaño de la base: 152x124mm

REF



4720

20T

9,64kg

2x

Macaco de garrafa 30T
 Gato de botella 30T

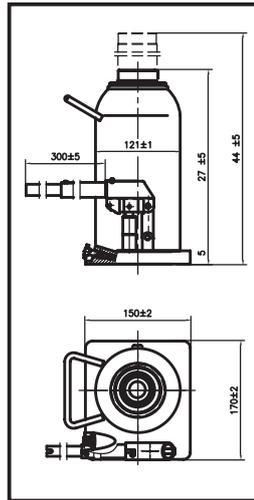

Características:
 Altura mínima: 275mm
 Altura máxima: 440mm
 Tamanho da base: 170x150mm

Características:
 Altura mínima: 275mm
 Altura máxima: 440mm
 Tamaño de la base: 170x150mm

REF

4730



30T



12,1kg



1x

Macaco de garrafa 50T
 Gato de botella 50T

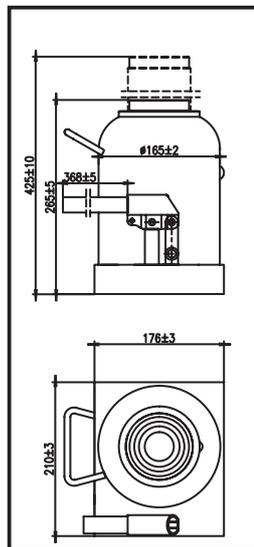

Características:
 Altura mínima: 265mm
 Altura máxima: 425mm
 Tamanho da base: 210x176mm

Características:
 Altura mínima: 265mm
 Altura máxima: 425mm
 Tamaño de la base: 210x176mm

REF

4750



50T



25,3kg



1x

Macaco posicionamento embraiagem 135KG
 Gato embregue 135KG



Características:
 Capacidade: 135kgs
 Altura mínima: 288mm
 Altura máxima: 980mm
 Largura do macaco: 609,6mm
 Comprimento do macaco: 1041,4mm

Características:
 Capacidad: 135kgs
 Altura mínima: 288mm
 Altura máxima: 980mm
 Anchura del gato: 609,6mm
 Longitud del gato: 1041,4mm

REF

4920



135KG



60kg



1x

 Macaco elevação e posicionamento rodas tractor 1200kg
 Gato elevación y posicionamiento ruedas tractor 1200kg



 **Características:**
Capacidade máxima: 1200Kg
Dimensões: 1310x980x1270mm
Diâmetro mínimo da roda: 1000mm
Diâmetro máximo da roda: 2200mm
Largura máxima da roda: 800mm

 **Características:**
Capacidad máxima: 1200Kg
Dimensiones: 1310x980x1270
Diámetro mínimo de la rueda: 1000mm
Diámetro máximo de la rueda: 2200mm
Ancho máximo de rueda: 800mm

REF

4930



1200kg



118kg



1x

 Macaco de transmissão 500kg

 Gato de foso 500kg

 Borracha topo 30mm
 Gomma topo 30mm

REF 4825B30

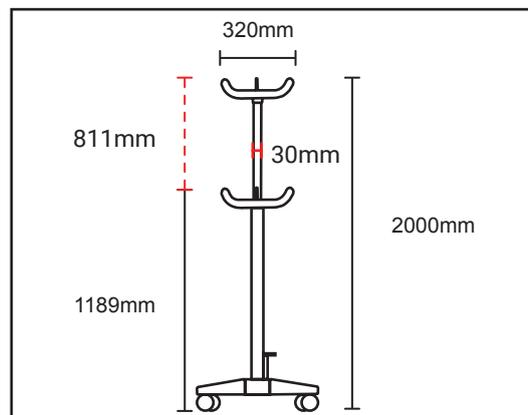

Características:
 Altura mínima: 1189mm
 Altura máxima: 2000mm
 Curso: 811mm
 Dupla bomba e válvula segurança

Características:
 Altura mínima: 1189mm
 Altura máxima: 2000mm
 Curso: 811mm
 Bomba doble y válvula de seguridad

REF

4825



500kg



28kg



1x

 Macaco transmissão 1T 940-1940mm

 Gato de foso 1T 940-1940mm

Características:
 Altura mínima: 940mm
 Altura máxima: 1940mm
 Curso: 1.ª etapa: 490mm
 2.ª etapa: 510mm

Características:
 Altura mínima: 940mm
 Altura máxima: 1940mm
 Curso: 1.º paso: 490mm
 2.º paso: 510mm

REF

4845



1T



74,5kg



1x

-  Macaco de transmissão 1000kg
-  Gato de foso 1000kg



 **Características:**
 Altura mínima: 1155mm
 Altura máxima: 1960mm
 Curso: 805mm

 **Características:**
 Altura mínima: 1155mm
 Altura máxima: 1960mm
 Curso: 805mm

REF			
4827	1T	42,5kg	1x

-  Adaptadores macaco de transmissão 500kg (REF 4825)
-  Adaptadores gato foso 500kg (REF 4825)



REF			
4820A23	23mm	300gr	1x
4820A24	24mm	100gr	1x
4820A25	25mm	100gr	1x
4820A28	28mm	300gr	1x
4820A30	30mm	300gr	1x

-  Borracha topo (REF 4825)
-  Goma topo (REF 4825)



REF			
4820B30	30mm	100gr	1x
4820B33	33mm	100gr	1x

 Suporte caixas velocidades para macaco (REF 4825)

 Adaptador para gato foso (REF 4825)



 Capacidade: 0.5T
Diâmetro do encaixe: 30mm

 Capacidad: 0.5T
Diámetro de la adaptación: 30mm

REF



4821

9kg

1x

 Suporte Mcpherson para macaco transmissão (REF 4825)

 Soporte Mcpherson para gato de foso (REF 4825)



REF



4826

2,6kg

5x

 Bomba hidráulica manual com manómetro

 Bomba hidráulica manual con manómetro



 **Características:**

Válvula de alívio de pressão interna para proteção contra sobrecarga
 Pressão de trabalho:
 Baixa pressão: 0-20kg / cm²
 Alta pressão: 20-700kg / cm²
 Deslocamento do óleo por curso:
 Baixa pressão: 13cc
 Alta pressão: 2,3cc
 Reservatório: Capacidade de óleo - 1200cc
 Capacidade de óleo utilizável - 700cc
 Comprimento das mangueiras: 2 mangueiras (1,8m e 1m)
 com engate incluído

 **Características:**

Válvula de alivio de presión interna para protección contra sobrecargas
 Presión trabajo:
 Baja presión: 0 - 20 kg / cm²
 Alta presión: 20 - 700 kg / cm²
 Desplazamiento de aceite por carrera:
 Baja presión: 13cc
 Alta presión: 2,3cc
 Depósito: Capacidad de aceite - 1200cc
 Capacidad de aceite utilizable: 700cc
 Longitud de las mangueras: 2 mangueras (1,8m y 1m)
 con acoplador incluído

REF



8457

10,3kg

1x

 Suporte para prensa hidráulica
 Soporte para prensa hidráulica



 **Características:**
Três pontos de contacto
Altura parafusos ajustável
Suportes alinhamento de segurança
Hastes suporte: 110, 150, 190mm

 **Características:**
Tres puntos de contacto
Altura de los tornillos ajustable
Soportes de alineación de seguridad
Varillas de soporte: 110, 150, 190mm

REF

2060



10kg



2x

 Suporte para prensa hidráulica
 Soporte para prensa hidráulica



 **Características:**
Cinco hastes roscadas de ajuste/retenção:
1 haste roscada com 105mm de comprimento
3 hastes roscadas com 150mm de comprimento
1 haste roscada com 190mm de comprimento
Estrutura de suporte universal para prensas de 20-30 toneladas

 **Características:**
Cinco varillas roscadas de ajuste/retención:
1 varilla roscada de 105 mm de longitud
3 varillas roscadas de 150 mm de longitud
1 varilla roscada de 190 mm de longitud
Estructura de soporte universal para prensas de 20-30 toneladas

REF

2061



7,75kg



2x

 Prensa hidráulica manual 20T
 Prensa hidráulica manual 20T

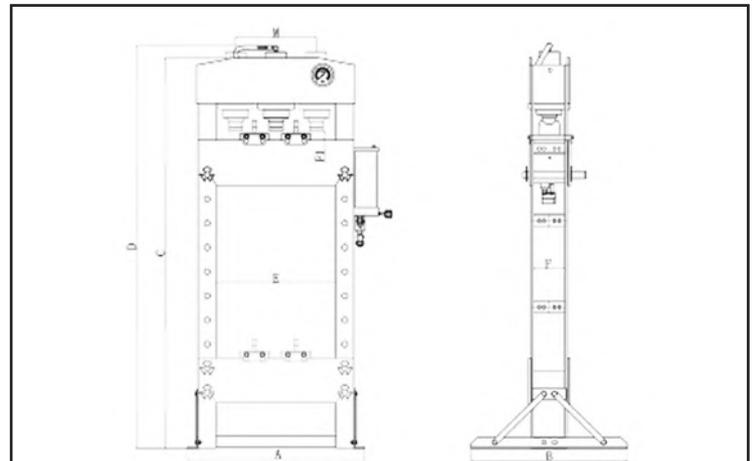

 **Características:**
Curso: 185mm
Alcance de trabalho: 78-890mm
Dimensões: A-700mm, B-540mm, C-1520mm, D-1660mm, E-480mm, F-120mm, F1/F2-78-890mm, M-190mm

 **Características:**
Curso: 185mm
Rango de trabajo: 78-890mm
Dimensiones: A-700mm, B-540mm, C-1520mm, D-1660mm, E-480mm, F-120mm, F1/F2-78-890mm, M-190mm

REF

4891



20T



96kg



1x

 Prensa hidráulica manual 30T

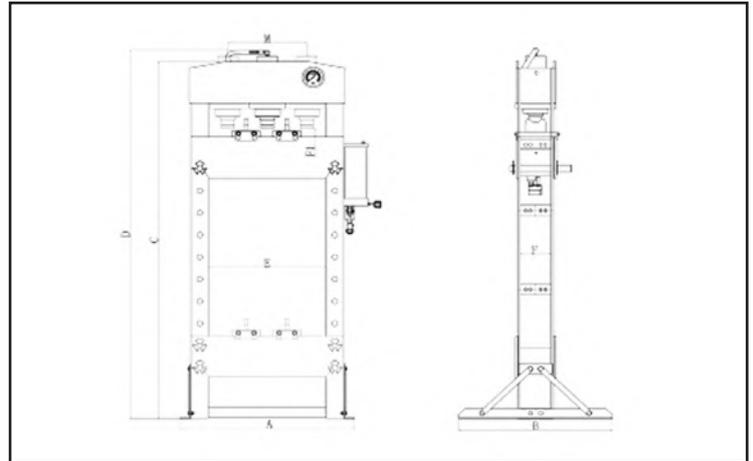
 Prensa hidráulica manual 30T

 **Características:**

Curso: 150mm

Alcance de trabalho: 55-1035mm

Dimensões: A-750mm, B-660mm, C-1720mm, D-1775mm, E-490mm, F-132mm, F1/F2-55-1035mm, M-190mm

 **Características:**

Curso: 150mm

Rango de trabajo: 55-1035mm

Dimensiones: A-750mm, B-660mm, C-1720mm, D-1775mm, E-490mm, F-132mm, F1/F2-55-1035mm, M-190mm

REF

4892



30T



130kg



1x

 Ecrã protecção prensa 20T

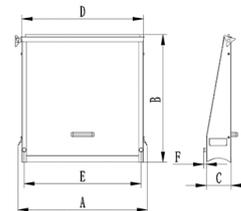
 Pantalla protección prensa 20T

 **Dimensões:** A-476mm, B-615mm, C-120mm, D-446mm, E-424mm, F-15,5mm
Materiais: Metal e plástico
 **Dimensiones:** A-476mm, B-615mm, C-120mm, D-446mm, E-424mm, F-15,5mm
Materiales: Metal y plástico

REF

4898-01



3,75kg



1x

 Ecrã protecção p/ prensas 30T

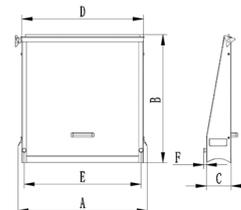
 Pantalla de protección p/ prensas 30T

 **Dimensões:** A-476mm, B-615mm, C-120mm, D-446mm, E-424mm, F-17,5mm
Materiais: Metal e plástico
 **Dimensiones:** A-476mm, B-615mm, C-120mm, D-446mm, E-424mm, F-17,5mm
Materiales: Metal y plástico

REF

4899-01



3,75kg



1x

 Kit de pinos para prensas 20/30T
 Kit de pin para prensas 20/30T



 Suporte conjunto de pinos: 150x92x90mm

Pins:

- (1x) 2T Ø25×Ø10×90mm
- (1x) 3T Ø25×Ø12×90mm
- (1x) 6T Ø25×Ø16×90mm
- (1x) 8T Ø25×Ø18×115mm
- (1x) 10T Ø25×Ø20×115mm
- (1x) 12T Ø25×Ø22×115mm
- (1x) 13T Ø25×Ø25×140mm
- (1x) 15T Ø25×Ø30×140mm

 Soporte kit de pinos: 150x92x90mm

Pins:

- (1x) 2T Ø25×Ø10×90mm
- (1x) 3T Ø25×Ø12×90mm
- (1x) 6T Ø25×Ø16×90mm
- (1x) 8T Ø25×Ø18×115mm
- (1x) 10T Ø25×Ø20×115mm
- (1x) 12T Ø25×Ø22×115mm
- (1x) 13T Ø25×Ø25×140mm
- (1x) 15T Ø25×Ø30×140mm

REF

4898-02



4kg



1x

 Prensa hidráulica 15T dupla velocidade e pedal
 Prensa hidráulica 15T doble velocidad y pedal

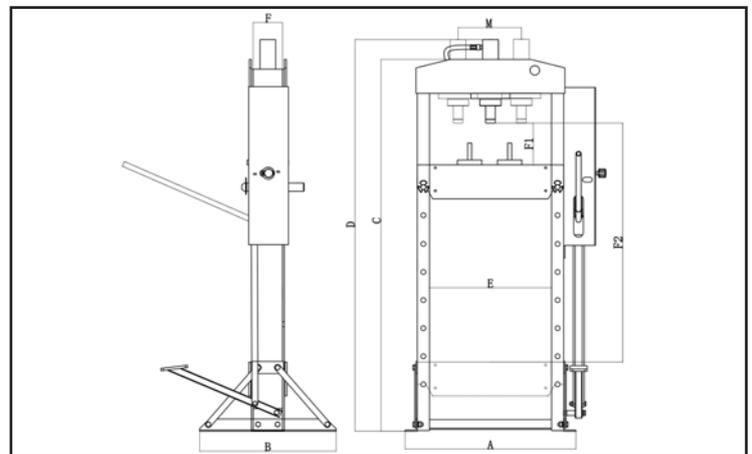

 **Características:**

Intervalo de trabalho: 168-980mm
Curso: 160mm
Medidas: A-700mm, B-560mm, C-1533mm, D-1616mm, E-500mm, F-120mm, F1/F2-173-985mm, M-169mm

 **Características:**

Rango de trabajo: 168-980 mm
Curso: 160mm
Medidas: A-700mm, B-560mm, C-1533mm, D-1616mm, E-500mm, F-120mm, F1/F2-173-985mm, M-169mm

REF

4880



15T



91,5kg



1x

-  Prensa hidráulica 30Ton dupla velocidade e pedal
 Prensa hidráulica 30Ton doble velocidad y pedal

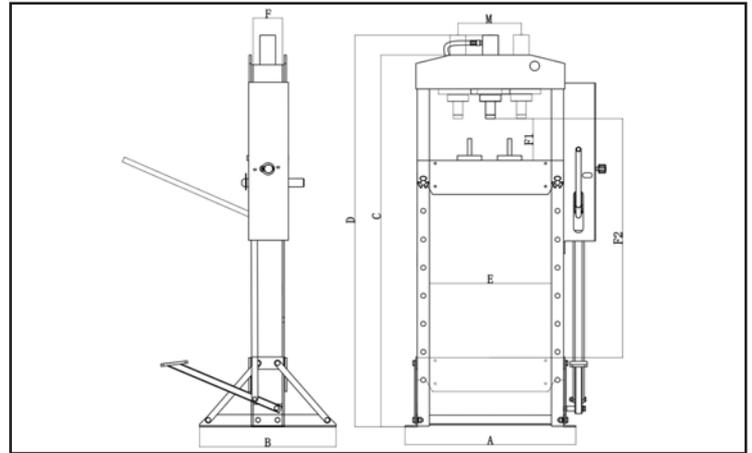

-  **Características:**
 Intervalo de trabalho: 151-1031mm
 Curso: 150mm
 Medidas: A-795mm, B-700mm, C-1773mm, D-1830mm, E-535mm, F-140mm, F1/F2-151-1031mm, M-200mm

-  **Características:**
 Rango de trabajo: 151-1031mm
 Curso: 150mm
 Medidas: A-795mm, B-700mm, C-1773mm, D-1830mm, E-535mm, F-140mm, F1/F2-151-1031mm, M-200mm

REF

4885



35T



166,7kg



1x

-  Prensa hidráulica 50T dupla velocidade e pedal
 Prensa hidráulica 50T doble velocidad y pedal

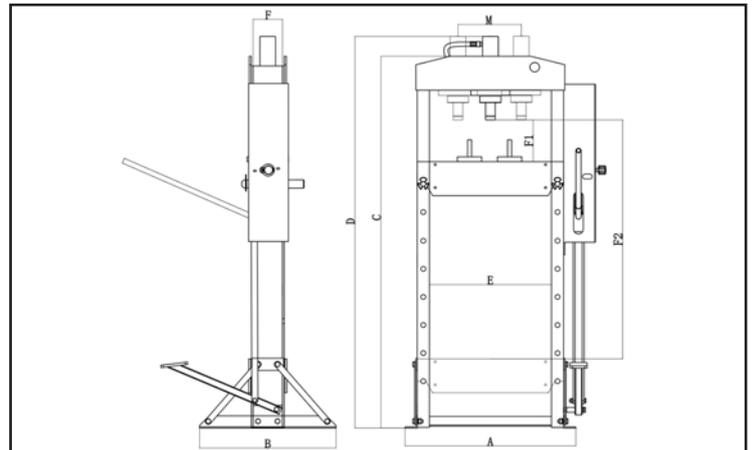

-  **Características:**
 Intervalo de trabalho: 68-1048mm
 Curso: 200mm
 Medidas: A-1030mm, B-800mm, C-1831mm, D-1877mm, E-730mm, F-207mm, F1/F2-68-1048mm, M-245mm

-  **Características:**
 Rango de trabajo: 68-1048mm
 Curso: 200mm
 Medidas: A-1030mm, B-800mm, C-1831mm, D-1877mm, E-730mm, F-207mm, F1/F2-68-1048mm, M-245mm

REF

4890



50T



298kg



1x

 Prensa hidráulica 100T dupla velocidade elétrica
 Prensa hidráulica 100T doble velocidad eléctrica

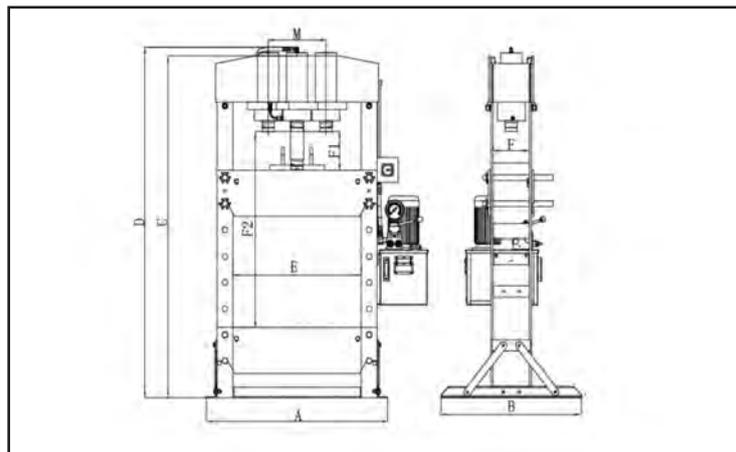

 **Características:**
Curso: 300mm
Intervalo de trabalho: 113-813mm
Medidas: A-1199mm, B-990mm, C-1830mm, D-1865mm, E-787mm, F-268mm, F1/F2-113-813mm, M-255mm

 **Características:**
Curso: 300mm
Rango de trabajo: 113-813mm
Medidas: A-1199mm, B-990mm, C-1830mm, D-1865mm, E-787mm, F-268mm, F1/F2-113-813mm, M-255mm

REF			
4897	100T	758kg	1x

 Ecrã protecção p/ prensas 20T/30T 4880/4891/4892
 Pantalla de protección p/ prensas 20T/30T 4880/4891/4892

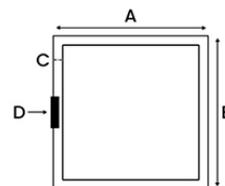

 **Dimensões:** A-520mm, B-515mm, C-20mm, D-80mm
Materiais: Alumínio e Policarbonato

 **Dimensiones:** A-520mm, B-515mm, C-20mm, D-80mm
Materiales: Alumínio y Policarbonato

REF		
4880E	3,25kg	1x

 Ecrã protecção p/ prensas 30T 4885
 Pantalla de protección p/ prensas 30T 4885

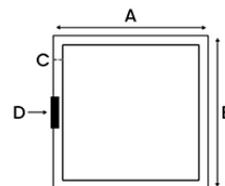

 **Dimensões:** A-520mm, B-485mm, C-20mm, D-80mm
Materiais: Alumínio e Policarbonato

 **Dimensiones:** A-520mm, B-485mm, C-20mm, D-80mm
Materiales: Alumínio y Policarbonato

REF		
4885E	3,25kg	1x

-  Ecrã protecção p/ prensas 50T 4890
 Pantalla de proteccion p/ prensas 50T 4890

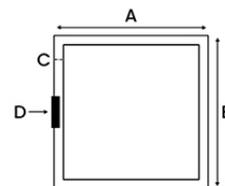
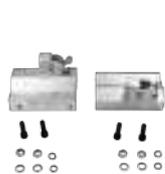

 **Dimensões:** A-625mm, B-675mm, C-20mm, D-80mm
Materiais: Alumínio e Policarbonato

 **Dimensiones:** A-625mm, B-675mm, C-20mm, D-80mm
Materiales: Alumínio y Policarbonato

REF

4890E



4,5kg



1x

-  Ecrã protecção p/ prensas 100T 4897
 Pantalla de proteccion p/ prensas 100T 4897

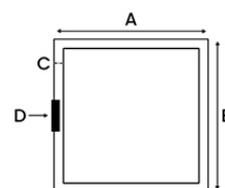

 **Dimensões:** A-730mm, B-775mm, C-20mm, D-80mm
Materiais: Alumínio e Policarbonato

 **Dimensiones:** A-730mm, B-775mm, C-20mm, D-80mm
Materiales: Alumínio y Policarbonato

REF

4897E



5,3kg



1x

-  Kit 6pcs acessórios prensa
 Kit de accesorios de prensa de 6 piezas



 **Características:**
 (2x) Bloco de aço
 (1x) Pino de 5T
 (1x) Pino de 36T
 (1x) Pino de 50T
 (1x) Escudo de rolamento

 **Características:**
 (2x) Bloque de acero
 (1x) Pino de 5T
 (1x) Pino de 36T
 (1x) Pino de 50T
 (1x) Escudo de rodamiento

REF

4881



12,3 kg



1x

-  Kit 8pcs acessórios prensa
 Kit de accesorios de prensa de 8 piezas



 **Características:**
 (2x) Bloco de aço
 (1x) Pino de 5T
 (1x) Pino de 16T
 (1x) Pino de 26T
 (1x) Pino de 40T
 (1x) Pino de 50T
 (1x) Escudo de rolamento

 **Características:**
 (2x) Bloque de acero
 (1x) Pino de 5T
 (1x) Pino de 16T
 (1x) Pino de 26T
 (1x) Pino de 40T
 (1x) Pino de 50T
 (1x) Escudo de rodamiento

REF

4882



14,5 kg



1x

Grúa desdobrável 1T
Grúa plegable 1T



Roda giratória 3"
Rueda rotativa 3"



REF 4865R3

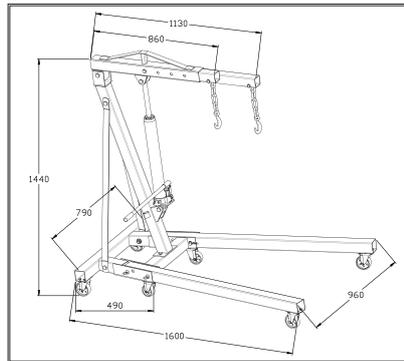

Características:
Capacidade: 1T
Altura mínima: 180mm; Altura máxima: 1960mm
Posições de suporte: 1000Kg, 750Kg, 500Kg, 250Kg

Características:
Capacidad: 1T
Altura mínima: 180mm; Altura máxima: 1960mm
Posiciones de soporte: 1000Kg, 750Kg, 500Kg, 250Kg

REF			
4860		61,9kg	1x

Grúa desdobrável 1T
Grúa plegable 1T

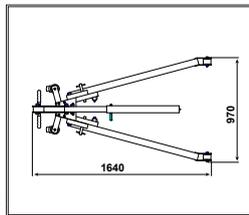
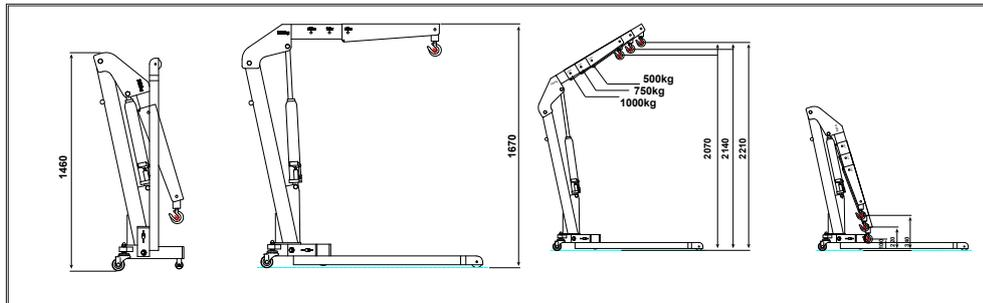

Características:
Capacidade: 1 Tonelada
Altura mínima: ≤ 85mm; Altura máxima: 2210mm
Posições de suporte: 1000Kg, 750Kg, 500Kg

Características:
Capacidad: 1 Tonelada
Altura mínima: ≤ 85mm; Altura máxima: 2210mm
Posiciones de soporte: 1000Kg, 750Kg, 500Kg

REF			
4863		74kg	1x

Grúa desdobrável 1T - pro series
Grúa plegable 1T - pro series

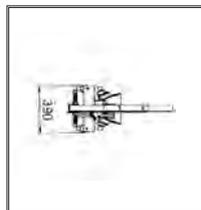
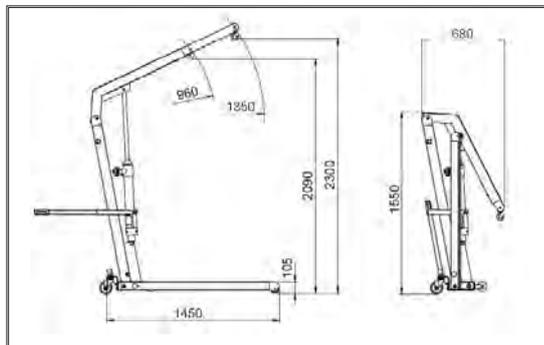
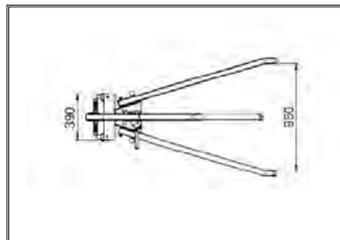

Características:
Capacidade: 1T
Altura mínima: 1550mm; Altura máxima: 2300mm
Posições de suporte: 1000kg, 900kg, 800kg, 700kg, 600kg

Características:
Capacidad: 1T
Altura mínima: 1550mm; Altura máxima: 2300mm
Posiciones de soporte: 1000kg, 900kg, 800kg, 700kg, 600kg

REF			
4864		88kg	1x

 Grua desdobrável 2T
 Grúa plegable 2T



Roda giratória 3"
Rueda rotativa 3"



REF 4865R3

Roda giratória 3,5"
Rueda rotativa 3,5"



REF 4865R35

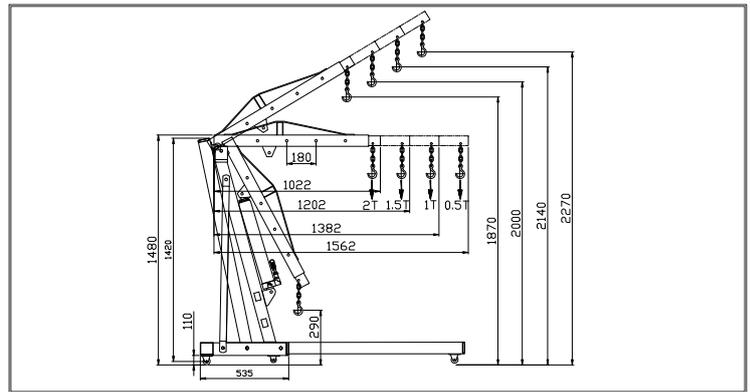
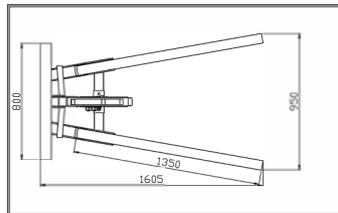

 **Características:**
 Capacidade: 2T
 Altura mínima: 290mm; Altura máxima: 2270mm
 Posições de suporte: 2000kg, 1500kg, 1000kg, 500kg

 **Características:**
 Capacidad: 2T
 Altura mínima: 290mm; Altura máxima: 2270mm
 Posiciones de soporte: 2000kg, 1500kg, 1000kg, 500kg

REF

4865



75kg



1x

 Grua desdobrável hidráulica 3T
 Grúa plegable 3T

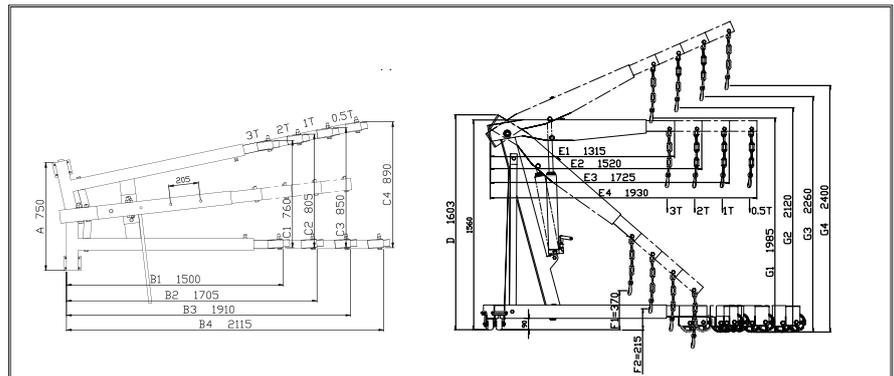

 **Características:**
 Capacidade: 3T
 Altura mínima: 0mm; Altura máxima: 2400mm
 Posições de suporte: 3000kg, 2000kg, 1000kg, 500kg

 **Características:**
 Capacidad: 3T
 Altura mínima: 0mm; Altura máxima: 2400mm
 Posiciones de soporte: 3000kg, 2000kg, 1000kg, 500kg

REF

4867



111,5kg



1x

 Equilibrador de carga 900kg para gruas
 Equilibrador de carga para grúa - 900kg



 **Características:**
 Capacidade: 900kg
 Curso operacional: 340mm

 **Características:**
 Capacidad: 900kg
 Curso operativo: 340mm

REF

4868



5kg



1x

FERRAMENTA LUBRIFICAÇÃO
HERRAMIENTA LUBRICACIÓN

12



KROFtools
PROFESSIONAL TOOLS

 FAMÍLIA	PÁGINAS
01 FERRAMENTA MANUAL	11-106
02 ALICATES	109-120
03 BITS E CONJUNTOS	123-134
04 FERRAMENTA ESPECÍFICA	137-214
05 FERRAMENTA CARROÇARIA	217-222
06 REGULAÇÃO E TESTE	225-246
07 FERRAMENTA MOTOR	249-276
08 KITS SINCRONIZAÇÃO	279-350
09 FERRAMENTA ELÉTRICA	353-362
10 FERRAMENTA PNEUMÁTICA	365-378
11 FERRAMENTA HIDRÁULICA	381-404
12 FERRAMENTA LUBRIFICAÇÃO	407-414
13 EQUIPAMENTO GARAGEM	417-502
RT ROUPA DE TRABALHO	505-508
MR MERCHANDISING	511-514
EP EXPOSITORES	517-524
LR LOCALIZAÇÃO REFERÊNCIAS	527-538

 FAMILIA	PÁGINAS
01 HERRAMIENTA MANUAL	11-106
02 ALICATES	109-120
03 PUNTAS Y CONJUNTOS	123-134
04 HERRAMIENTA ESPECÍFICA	137-214
05 HERRAMIENTA DE CARROCERIA	217-222
06 REGULACIÓN Y PRUEBAS	225-246
07 HERRAMIENTA PARA MOTOR	249-276
08 KIT CALADO	279-350
09 HERRAMIENTA ELÉCTRICA	353-362
10 HERRAMIENTA NEUMÁTICA	365-378
11 HERRAMIENTA HIDRÁULICA	381-404
12 HERRAMIENTA LUBRICACIÓN	407-414
13 EQUIPAMENTO PARA TALLER	417-502
RT ROPA DE TRABAJO	505-508
MR MERCHANDISING	511-514
EP EXPOSITORES	517-524
LR LOCALIZACIÓN REFERENCIAS	527-538



 Bomba massa manual 13kg

 Engrasadora manual 13kg



 **Características:**
Tanque: 13kg
Manguera: 1/4" 2,5m
Fluxo pistola massa: 250-300 g/min
Pressão saída: 350-400 BAR

 **Características:**
Depósito: 13kg
Manguera de 1/4" 2,5m
Caudal pistola grasa: 250-300 g/min
Presión salida: 350-400 BAR

REF

3560



10kg



1x

 Bamba massa manual pé 13kg

 Engrasadora manual pie 13kg



 **Características:**
Tanque: 13 kg
Manguera: 1/4" 4 m
Fluxo pistola massa: 250-300 g/min
Pressão saída: 300-350BAR

 **Características:**
Depósito: 13 kg
Manguera: 1/4" 4 m
Caudal de pistola de grasa: 250-300 g/min
Presión salida: 300-350 BAR

REF

3550



11kg



1x

 Bomba massa pneumática 50:1 730mm

 Engrasadora neumatica 50:1 730mm



 **Características:**
Taxa de compressão: 50:1
Entrada de ar: F 1/4" G
Saída de óleo: M 1/4" G
Pressão de trabalho: 8BAR
Pressão máxima de fluxo: 400BAR
Consumo de ar: 120L/min
Capacidade relativa: 800g/min
Diâmetro do tubo de sucção: 30mm

 **Características:**
Relación de compresión: 50:1
Entrada de aire: F1/4" G
Salida de aceite: M 1/4" G
Presión de trabajo: 8BAR
Presión máxima de flujo: 400BAR
Consumo de aire: 120L/min
Capacidad relativa: 800g/min
Diámetro del tubo de succión: 30mm

REF

3530



5,5kg



6x

 Bomba massa pneumática 65:1 940mm
 Engrasadora neumatica 65:1 940mm



 **Características:**
 Taxa de compressão: 65:1
 Entrada de ar: F 1/4" G
 Saída de óleo: M 1/4" G
 Pressão de trabalho: 8BAR
 Pressão máxima de fluxo: 400BAR
 Consumo de ar: 120L/min
 Capacidade relativa: 800g/min
 Diâmetro do tubo de sucção: 30mm

 **Características:**
 Relación de compresión: 65:1
 Entrada de aire: H 1/4" G
 Salida de aceite: M 1/4" G
 Presión de trabajo: 8BAR
 Presión máxima de flujo: 400BAR
 Consumo de aire: 120L/min
 Capacidad relativa: 800g/min
 Diámetro del tubo de succión: 30mm

REF



3540

6kg

6x

 Bomba óleo pneumática 5:1 1250mm
 Bomba aceite neumatica 5:1 1250mm



 **Características:**
 Relação de compressão: 5:1
 Ligaçãõ de entrada de ar: F1/4" G
 Ligaçãõ de saída de óleo: M 1/2" G
 Pressão de trabalho: 8bar
 Pressão máx. de fluxo: 40bar
 Consumo de ar: 125L/min
 Capacidade relativa: 14L/min
 Diâmetro do tubo de sucção: 42mm

 **Características:**
 Relación de compresión: 5:1
 Conexión de entrada de aire: F1/4" G
 Conexión de salida de aceite: M1/2" G
 Presión de trabajo: 8bar
 Presión de flujo máx.: 40bar
 Consumo de aire: 125L/min
 Capacidad relativa: 14L/min
 Diámetro del tubo de aspiración: 42mm

REF



8315

6,17kg

6x

 Bomba óleo pneumática 5:1 940mm
 Bomba aceite neumatica 5:1 940mm



 **Características:**
 Relação de compressão: 5:1
 Ligaçãõ de entrada de ar: F1/4" G
 Ligaçãõ de saída de óleo: M1/2" G
 Pressão de trabalho: 8bar
 Pressão máx. de fluxo: 40bar
 Consumo de ar: 125L/min
 Capacidade relativa: 14L/min
 Diâmetro do tubo de sucção: 42mm

 **Características:**
 Relación de compresión: 5:1
 Conexión de entrada de aire: F1/4" G
 Conexión de salida de aceite: M 1/2" G
 Presión de trabajo: 8bar
 Presión de flujo máx.: 40bar
 Consumo de aire: 125L/min
 Capacidad relativa: 14L/min
 Diámetro del tubo de aspiración: 42mm

REF



8325

6kg

6x

 Kit bomba massa manual 310mm com trolley
 Kit engrasadora manual 310mm con carro



 **Características:**
Tampa balde: 310 mm
Tampa Membrana: 310 mm
Pistola de massa: 1/4" x 2,5 m
Taxa fluxo: 250-300 g / min
Pressão máxima saída: 350-400 BAR

 **Características:**
Tapa cubeta: 310 mm
Cubierta de membrana: 310 mm
Pistola de grasa: 1/4" x 2,5 m
Velocidad de flujo: 250-300 g / min
Presión máxima de salida: 350-400 BAR

REF



3570

10kg

1x

 Kit bomba massa pneumática com trolley 20-60kg
 Kit engrasadora neumática con carro 20-60kg



 **Características:**
Trolley: 20-60Kg
Tampa balde: 310mm
Tampa membrana: 310mm
Pistola: 1/4"x4m
Bomba de lubrificação pneumática: Rácio: 50:1, 730mm
Pistola de lubrificação: Com terminal rígido

 **Características:**
Carro: 20-60Kg
Tapa del cubo: 310mm
Cubierta de membrana: 310mm
Pistola: 1/4"x4m
Bomba de engrase neumática: Proporción: 50:1, 730mm
Pistola de engrase: Con terminal rígido

REF



3520

21kg

1x

 Trolley p/ kit bomba óleo
 Carro para kit bomba aceite



 **Características:**
Aplicação de bidões: 180~220Kg
NOTA: Compatível com REF. 3530, 3540, 8325 e 8315

 **Características:**
Aplicación de bidones: 180~220Kg
NOTA: Compatible con REF. 3530, 3540, 8325 y 8315

REF



8334

19kg

1x

 Kit bomba óleo 5:1 pneumática com trolley 180-220kg

 kit bomba 5:1 aceite neumatica con carro 180-220kg



 **Características pistola medidora óleo:**

Taxa de fluxo: 0-35L/m
 Pressão operacional (máxima): 1500psi/100bar
 Temperatura de trabalho: -10°C+50°C
 Precisão: ±0,3%
 Viscosidade aplicada do fluido: 8-5000mPas
 Ecrã LCD de 5 Dígitos
 Ligações de entrada e saída GNP 1/2"

Características bomba óleo:

Relação de compressão: 5:1
 Pressão operacional (bar/psi): 5-8bar/70-115psi
 Consumo de ar (L/min): 125L/min
 Capacidade (L/m): 14L/min
 Diâmetro do tubo (mm/polegada): 42mm/1.65inch
 Comprimento do tubo de aspiração (mm/polegada): 940mm/37inch
 Entrada de ar: 1/4" ficha rápida / 1/4" NPT Feminino
 Saída de óleo: Masculino 1/2"
 Tipo de óleo (Viscosidade): 240SAE
 Temperatura do óleo: -10~50°C
 Nível de ruído (dB): 82dB

 **Características pistola medidora de aceite:**

El caudal varió: 0-35L/m
 Presión de funcionamiento (máxima): 1500psi/100bar
 Temperatura de trabajo: -10°C+50°C
 Precisión: ±0,3%
 Viscosidad aplicada del fluido: 8-5000mPas
 Pantalla LCD de 5 dígitos
 Conexiones entrantes y salientes: PNB 1/2"

Características bomba de aceite:

Relación de compresión: 5:1
 Presión de funcionamiento (bar/psi): 5-8bar/70-115psi
 Consumo de aire (L/min): 125L/min
 Capacidad (L/m): 14L/min
 Diámetro del tubo (mm/pulgada): 42mm/1.65inch
 Longitud del tubo de succión (mm/pulgada): 940mm/37inch
 Entrada de aire: 1/4" ficha rápida / 1/4" NPT Feminino
 Salida de aceite: Masculino 1/2"
 Tipo de aceite (Viscosidad): 240SAE
 Temperatura del aceite: -10~50°C
 Nivel de ruido (dB): 82dB

REF



8301

30kg

1x

 Placa seguidora

 Membrana

310mm



REF 3571

400mm



REF 3575

REF



3571

1kg

1x

3575

1,50kg

1x

 Tampa bidão 420mm

 Cubierta del tambor 420mm



 **Características:**

Material: Aço

 **Características:**

Material: Acero

REF



3574

2,40kg

1x

-  Cardan destorcedor de massa 1/4" M / F
-  Cardan giratório graser 1/4" M / H



 **NOTA:**
Compatível com Kit bomba massa manual 310mm c/trolley Ref: 3570

 **NOTA:**
Compatible con kit engrasadora manual 310mm con carro Ref: 3570

REF		
3582	312gr	80x

-  Bico lubrificador 4 palhetas
-  Boquilla lubrificador 4 garras



 **Características:**
Rosca tubo 1/8" (NPT)
Encaixe 4 palhetas
Encaixa na maioria das pistolas de massa manuais

 **Características:**
Rosca de tubo de 1/8" (NPT)
Enchufe 4 garras
Se adapta a la mayoría de las pistolas grasa manuales

REF		
3584	45gr	100x

-  Tubo flexível 450mm para bomba massa
-  Tubo flexible 450mm para engrasadora



 **Características:**
Pressão funcionamento 3000PSI, Tubo rosca 1/8" (NPT)
Encaixa na maioria das bombas de massa manuais
Ideal para áreas difíceis de alcançar

 **Aviso:** Não usar com pistolas de massa pneumáticas ou elétricas

 **Características:**
Presión de funcionamiento de 3000PSI, Tubo roscado de 1/8" (NPT)
Se adapta a la mayoría de las pistolas engrase manuales
Ideal para zonas de difícil acceso

 **Advertencia:** No lo use con pistolas engrase neumáticas o eléctricas

REF		
3585	90gr	50x

-  Tubo flexível 300mm para bomba massa
-  Tubo flexible 300mm para engrasadora

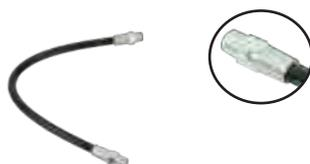

 **Características:**
Pressão funcionamento 3000PSI, Tubo rosca 1/8" (NPT)
Encaixa na maioria das bombas de massa manuais
Ideal para áreas difíceis de alcançar

 **Aviso:** Não usar com pistolas de massa pneumáticas ou elétricas

 **Características:**
Presión de funcionamiento de 3000PSI, Tubo roscado de 1/8" (NPT)
Se adapta a la mayoría de las pistolas engrase manuales
Ideal para zonas de difícil acceso

 **Advertencia:** No lo use con pistolas engrase neumáticas o eléctricas

REF		
3586	70gr	50x

-  Tubo massa 1/4" 145 BAR com engate 4 garras
-  Tubo graser 1/4" 145 BAR



 **Características:**
Pressão de trabalho: 400BAR / 5800psi
NOTA: Compatível com Kit bomba massa pneumática c/ trolley 20-60Kg, Ref: 3520

 **Características:**
Presión de trabajo: 400BAR / 5800psi
NOTA: Compatible con Kit engrasadora neumática con carro 20-60Kg, Ref: 3520

REF		
3581	500gr	30x

-  Pistola massa com tubo 1/4" 145BAR engate 4 garras
 Pistola grasera con tubo 1/4" 145BAR



-  **NOTA:** Compatível com Kit bomba massa pneumática c/ trolley 20-60Kg, Ref: 3520
-  **NOTA:** Compatible con Kit engrasadora neumática con carro 20-60Kg, Ref: 3520

REF		
3580	1,5kg	20x

-  Kit adaptadores pistola massa 12 peças
 Kit adaptadores engrasadora 12 piezas



-  **Características:**
 Mangueira flexível de 300mm com mola
 Adaptador ponta de agulha
 Agulha injeção de massa
 Agulha bico de massa
 Conector 90°
 Conector fenda 90°
 Bico com ponta de borracha
 Conector fêmea / fêmea de 1/8" NPT
 Encaixe de massa padrão e para serviços pesados
 Encaixe 360°
 Adaptador bico de agulha para pistola de massa 100mm com conectores rápidos pequenos e grandes
-  **Características:**
 Manguera flexible de resorte de 300mm
 Adaptador de punta de aguja
 Aguja de inyección de grasa
 Aguja de punta de grasa
 Conector de 90°
 Conector de ranura de 90°
 Punta de goma
 Conector hembra / hembra NPT de 1/8"
 Engrasador estándar y de alta resistencia
 Engrasador de 360°
 Adaptador de punta de aguja para pistola engrasadora de 100mm con conectores rápidos pequeños y grandes

REF		
3583	850gr	10x

-  Bomba massa duplo pistão 450CC
 Bomba grasa doble pistón 450CC



-  **Características:**
 Mangueira de metal 150mm,
 Mangueira flexível 300mm
 Pressão máxima de trabalho: 10000PSI
 Capacidade: 450CC
-  **Características:**
 Manguera de metal 150mm
 Manguera flexible 300mm
 Presión máxima de trabajo: 10000PSI
 Capacidad: 450CC

REF		
3510	1,4kg	20x

-  Bomba de massa pneumática e manual
 Engrasadora neumática y manual



-  **Características:**
 Cartuchos de massa: 500CC
 Fornece 1.0oz massa acada 100x cursos
-  **Características:**
 Cartuchos de grasa: 500CC
 Provee 1.0oz grasa a cada 100x cursos

REF		
3236	1,75kg	10x

-  Bomba massa 450CC
-  Engrasadora manual 450CC



REF		
3238	1,4kg	72x

-  Enrolador óleo/massa/água alta pressão 1/2"
-  Enrollador aceite/grasa/agua alta presión 1/2"



-  **Características:**
Diâmetro Interno mangueira: 1/2"
Comprimento da mangueira: 20m
Pressão de trabalho: 160 bar / 2320 psi
Conexão de entrada: F 1/2" G
Conexão de saída: M 1/2" G

-  **Características:**
Diámetro interno de la manguera: 1/2"
Longitud de la manguera: 20m
Presión de trabajo: 160 bar / 2320 psi
Conexión de entrada: F 1/2" G
Conexión de salida: M 1/2" G

REF				
2076	1/2"	20m	31kg	1x

-  Pistola óleo digital
-  Pistola aceite digital



-  **Características:**
Faixa de fluxo: 1-25L/min
Faixa de precisão: 0,5%
Pressão mínima de trabalho: 8 bar
Pressão máxima de trabalho: 70 bar

-  **Características:**
Rango de flujo: 1-25L/min
Rango de precisión: 0,5%
Presión mínima de trabajo: 8 bar
Presión máxima de trabajo: 70 bar

REF		
8340	1,8kg	10x

-  Pistola óleo com medidor digital
-  Pistola aceite con medidor digital



-  **Características:**
Intervalo de fluxo: 1-30L / min
Intervalo de precisão: 0,5%
Pressão mínima de trabalho: 8 bar
Pressão máxima de trabalho: 70 bar

-  **Características:**
Rango de flujo: 1-30L / min
Rango de precisión: 0,5%
Presión mínima de trabajo: 8 bar
Presión máxima de trabajo: 70 bar

REF		
8330	2kg	10x

 Medidor fluídos digital para pistola óleo
 Medidor digital para pistola aceite



 **Características:**
 Intervalo de fluxo: 25L/min
 Intervalo de precisão: 0,5%
 Rosca interna: M1/2" BSP
 Rosca externa: F1/2" BSP
 Pressão máxima de trabalho: 70BAR

 **Características:**
 Rango de flujo: 25L/min
 Rango de precisión: 0,5%
 Rosca interna: M1/2" BSP
 Rosca externa: H1/2" BSP
 Presión máxima de trabajo: 70BAR

REF



8331

166gr

4x

 Suporte parede bomba óleo
 Soporte pared bomba aceite



 **Diâmetro:** 30mm

 **Diámetro:** 30mm

REF



8333

30mm

400gr

1x

 Filtro regulador de pressão
 Filtro regulador de presión



 **Escala:** 0-150 psi, 0-1MPa

 **Escala:** 0-150 psi, 0-1MPa

REF



3573

1,5kg

40x

 Adaptador de tambor para bomba de óleo
 Tapón adaptador para bomba de aceite



 **Compatível com os artigos:** 8301, 8315, 8325

 **Compatible con los artículos:** 8301, 8315, 8325

REF



3572

42mm

100gr

50x

 Tubo óleo 1/2" 4m
 Tubo aceite 1/2" 4m



 **Características:**
Pressão de trabalho: 160bar / 2320psi

NOTA: Compatível com Kit bomba óleo pneumática c/ trolley 180-220Kg, Ref: 8301

 **Características:**
Presión de trabajo: 160bar / 2320psi

NOTA: Compatible con Kit bomba aceite neumática con carro 180-220Kg, Ref: 8301

REF



8332

1,8kg

15x

EQUIPAMENTO GARAGEM
EQUIPAMENTO PARA TALLER

13



KROFtools[®]
PROFESSIONAL TOOLS

 FAMÍLIA	PÁGINAS
01 FERRAMENTA MANUAL	11-106
02 ALICATES	109-120
03 BITS E CONJUNTOS	123-134
04 FERRAMENTA ESPECÍFICA	137-214
05 FERRAMENTA CARROÇARIA	217-222
06 REGULAÇÃO E TESTE	225-246
07 FERRAMENTA MOTOR	249-276
08 KITS SINCRONIZAÇÃO	279-350
09 FERRAMENTA ELÉTRICA	353-362
10 FERRAMENTA PNEUMÁTICA	365-378
11 FERRAMENTA HIDRÁULICA	381-404
12 FERRAMENTA LUBRIFICAÇÃO	407-414
13 EQUIPAMENTO GARAGEM	417-502
RT ROUPA DE TRABALHO	505-508
MR MERCHANDISING	511-514
EP EXPOSITORES	517-524
LR LOCALIZAÇÃO REFERÊNCIAS	527-538

 FAMILIA	PÁGINAS
01 HERRAMIENTA MANUAL	11-106
02 ALICATES	109-120
03 PUNTAS Y CONJUNTOS	123-134
04 HERRAMIENTA ESPECÍFICA	137-214
05 HERRAMIENTA DE CARROCERIA	217-222
06 REGULACIÓN Y PRUEBAS	225-246
07 HERRAMIENTA PARA MOTOR	249-276
08 KIT CALADO	279-350
09 HERRAMIENTA ELÉCTRICA	353-362
10 HERRAMIENTA NEUMÁTICA	365-378
11 HERRAMIENTA HIDRÁULICA	381-404
12 HERRAMIENTA LUBRICACIÓN	407-414
13 EQUIPAMENTO PARA TALLER	417-502
RT ROPA DE TRABAJO	505-508
MR MERCHANDISING	511-514
EP EXPOSITORES	517-524
LR LOCALIZACIÓN REFERENCIAS	527-538



Enrolador ar 12,5x18,8mm 12M PVC
Enrollador aire 12,5x18,8mm 12M PVC



Engates de ar não incluídos
Acoplamentos de aire no incluídos

Características:
Diâmetro da mangueira: 12,5x18,8mm
Adaptação: 3/8" BSPT
Pressão de trabalho/explosão: 120PSI

Características:
Diámetro de la manguera: 12.5x18.8mm
Adaptación: 3/8" BSPT
Presión de trabajo/de ráfaga: 120PSI

REF	⊖	↔	⚖	📦
2073	12,5x18,8mm	12+1m	10,2kg	1x

Enrolador ar 7,5x11,5mm 10M PVC
Enrollador aire 7,5x11,5mm 10M PVC

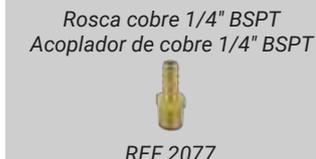

Engates de ar não incluídos
Acoplamentos de aire no incluídos

Características:
Diâmetro mangueira: 7,5x11,5mm
Adaptação: 1/4" BSPT
Pressão de trabalho/explosão: 120PSI

Características:
Diámetro de la manguera: 7,5x11,5mm
Adaptación: 1/4" BSPT
Presión de trabajo/de ruptura: 120PSI

REF	⊖	↔	⚖	📦
2074	7,5x11,5mm	10+1m	4,25kg	4x

Enrolador ar 8x12mm 20M
Enrollador de aire 8x12mm 20M

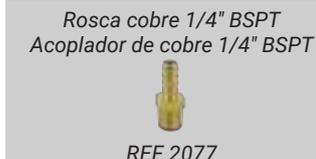

Engates de ar não incluídos
Acoplamentos de aire no incluídos

Características:
Diâmetro mangueira: 5/16"
Adaptação: 1/4" BSPT
Pressão de trabalho/explosão: 120PSI

Características:
Diámetro de la manguera: 5/16"
Adaptación: 1/4" BSPT
Presión de trabajo/de ruptura: 120PSI

REF	⊖	↔	⚖	📦
2088	5/16"	20+1m	7,9kg	1x

Enrolador de ar 10x14.5mm 20M
Enrollador de aire 10x14.5mm 20M

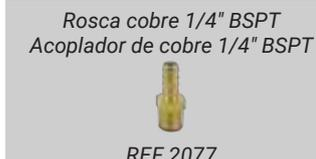

Engates de ar não incluídos
Acoplamentos de aire no incluídos

Características:
Diâmetro da mangueira: 10x14,50mm
Adaptação: 1/4" BSPT
Pressão de trabalho/explosão: 120PSI

Características:
Diámetro de la manguera: 10x14,50mm
Adaptación: 1/4" BSPT
Presión de trabajo/de ruptura: 120PSI

REF	⊖	↔	⚖	📦
2087	10x14,50mm	20+2m	10,3kg	1x

-  Enrolador de ar 8x12mm 15M
 Enrollador de aire 8x12mm 15M



Rosca cobre 1/4" BSPT
Acoplador de cobre 1/4" BSPT



REF 2077

-  Engates de ar não incluídos
 Acoplamentos de aire no incluídos

 **Características:**
 Diâmetro da mangueira: 5/16"
 Adaptação: 1/4" BSPT + EURO conector rápido
 Pressão de trabalho/explosão: 120PSI

 **Características:**
 Diámetro de la manguera: 5/16"
 Accesorio: 1/4" BSPT + conector rápido EURO
 Presión de trabajo/de ruptura: 120PSI

REF	⊕	↔	⚖	📦
2084	5/16"	15+1,5m	5kg	2x

-  Enrolador de água 1/2" 15M
 Enrollador de agua 1/2" 15M



 **Características:**
 Diâmetro da mangueira: 1/2"
 Encaixe: 3/4"
 Pressão de trabalho/explosão: 120PSI

 **Características:**
 Diámetro de la manguera: 1/2"
 Encaje: 3/4"
 Presión de trabajo/de ruptura: 120PSI

REF	⊕	↔	⚖	📦
2080	1/2"	15+1,5m	6,4kg	1x

-  Enrolador elétrico cabo 3x1.5mm 15M
 Enrollador eléctrico 3x1.5mm 15M



 **Características:**
 Cabo elétrico diâmetro: 3x1,5mm
 Voltagem: 230V
 Potência: 1000W/3000W

 **Características:**
 Diámetro del cable eléctrico: 3x1,5mm
 Voltaje: 230V
 Potencia: 1000W/3000W

REF	⊕	↔	⚖	📦
2085	3x1,5mm	15+1,5m	5,1kg	4x

-  Kit enroladores ar + eléctrico
 Kit enrolladores aire + eléctrico



 **AVISO:** Pistola de ar não incluída.
 Referência 2090 – PISTOLA SOPRAR 100mm e
 2093 – PISTOLA SOPRAR 250mm compatíveis.

 **NOTA:** Pistola de aire no incluida.
 Referencia 2090 - PISTOLA SOPLAR 100MM y
 2093 - PISTOLA SOPLAR 250MM compatibles.

 **Características:**
Mangueira de ar:
 Diâmetro: 6,5 x 10mm
 Comprimento: 10m
Cabo elétrico:
 Diâmetro: 3x1,5mm²

 **Características:**
Manguera de aire:
 Diámetro: 6,5 x 10mm
 Longitud: 10m
Cable eléctrico:
 Diámetro: 3x1,5mm²

REF	⊕	↔	⚖	📦
2075	6.5x10 / 3x1.5mm ²	10m	40kg	1x

Enrolador óleo/massa/água alta pressão 1/2"
Enrollador aceite/grasa/agua alta presión 1/2"



Características:
Diâmetro Interno mangueira: 1/2"
Comprimento da mangueira: 20m
Pressão de trabalho: 160 bar / 2320 psi
Conexão de entrada: F 1/2" G
Conexão de saída: M 1/2" G

Características:
Diámetro interno de la manguera: 1/2"
Longitud de la manguera: 20m
Presión de trabajo: 160 bar / 2320 psi
Conexión de entrada: F 1/2" G
Conexión de salida: M 1/2" G

REF	⊖	↔	⚖	📦
2076	1/2"	20m	31kg	1x

Tubo poliuretano enrolador ar
Tubo enrollador de aire



⚠ **NOTA:** Vendido ao metro. ⚠ **NOTA:** Se vende por metro.

Pressão máxima: 300psi

Presión máxima: 300psi

REF	⊖	⚖	📦
2084T	8x12mm	5gr	1x

Aparadeira de chão óleo 65L
Recogedor de aceite 65L

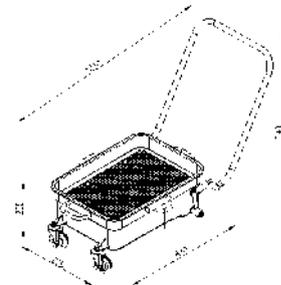

Características:
Tanque 65L equipado com válvula descarga rápida

Características:
Tanque de 65L equipado con válvula de descarga rápida

REF	⚖	📦
9725	20kg	1x

- Aspirador óleo 90L pantógrafo c/ visor
- Aspirador aceite pantografo con visualizador 90L

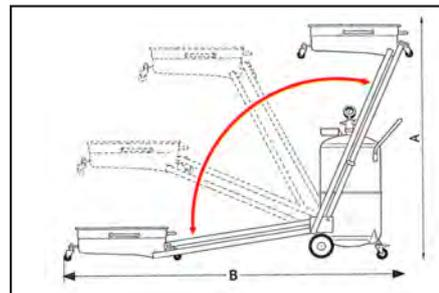

- Características:**
 - Capacidade tanque: 90L
 - Capacidade bacia: 14L
 - Capacidade visor: 8L
 - Tempo despressurização: 2min
 - Velocidade sucção (óleo 70-90°C, sonda 6mm): 1.5-2L/min
 - Capacidade total sucção: 60-65L
 - Manguera sucção: 2m
 - Manguera drenagem: 2m
 - Pressão máxima drenagem: 4-7 bar
 - A-1600mm, B-2460mm

- Características:**
 - Capacidad del depósito: 90L
 - Capacidad recogedor: 14L
 - Capacidad de visualizador: 8L
 - Tiempo de despresurización: 2min
 - Velocidad de aspiración (aceite 70-90°C, sonda 6mm): 1,5-2 L/min
 - Capacidad de succión total: 60-65L
 - Manguera de succión: 2m
 - Manguera de desagüe: 2m
 - Presión máxima de drenaje: 4-7 bar
 - A-1600mm, B-2460mm

REF

9700



51kg



1x

- Aspirador óleo 90L com visor
- Aspirador aceite con visualizador 90L

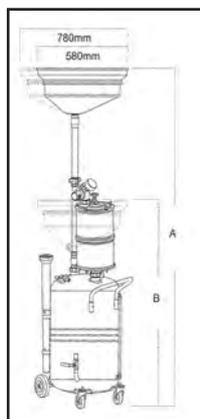

- Características:**
 - Capacidade tanque: 90L
 - Capacidade funil: 15L
 - Diâmetro visor: 580mm
 - Capacidade visor: 8L
 - Tempo despressurização: 2min
 - Velocidade sucção (óleo 70-90 °C, sonda 6 mm): 1.5-2 L/min
 - Capacidade total sucção: 60-65L
 - Manguera sucção: 2m
 - Manguera drenagem: 2m
 - Pressão máxima drenagem: 4-7 bar
 - A-1730mm, B-1190mm

- Características:**
 - Capacidad del depósito: 90L
 - capacidad embudo: 15L
 - Diámetro visualizador: 580mm
 - Capacidad de visualizador: 8L
 - Tiempo de despresurización: 2min
 - Velocidad aspiración (aceite 70-90 °C, sonda 6 mm): 1,5-2L / min
 - Capacidad de succión total: 60-65L
 - Manguera de succión: 2m
 - Manguera de drenaje: 2m
 - Presión máxima de drenaje: 4-7 bar
 - A-1730mm, B-1190mm

REF

9710



42kg



1x

 Aspirador óleo c/ visor + aparadeira reservatório 90L
 Aspirador aceite con visualizador 90L



Conjunto 3 varetas
Conjunto 3 varillas



REF 9730S3

Vareta óleo flex. 8mm
Varilla aceite flex. 8mm



REF 9730V8

Vareta óleo cobre
Varilla aceite cobre



REF 9730VC

Vareta óleo flex. 6mm
Varilla aceite flex. 6mm



REF 9730V6

Visor aspirador



REF 9730V

Manómetro



REF 9730M

 **Características:**

Pressão de trabalho e vácuo: 0.4-0.6MPa
Grau de vácuo: 0.05-0.07MPa
Altura máx. recolha de óleo: 1.85m
Capacidade do visor: 10L
Capacidade do reservatório: 90L
Comprimento do tubo de sucção do óleo: 1.5m
Comprimento do tubo de saída do óleo: 2m
Pressão descarga do óleo: 0.04MPa
Dimensões: 500X500X1850mm

 **Características:**

Presión de trabajo y vacío: 0.4-0.6MPa
Grado de vacío: 0.05-0.07MPa
Altura máxima de recogida de aceite: 1,85m
Capacidad del visualizador: 10L
Capacidad del tanque: 90L
Longitud del tubo de aspiración de aceite: 1.5m
Longitud del tubo de salida de aceite: 2m
Presión de descarga de aceite: 0.04MPa
Dimensiones: 500X500X1850mm

REF

9730



34,1kg



1x

 Engate rápido para aspirador de óleo - AUDI
 Conector para aspirador de aceite - AUDI



REF

9726



333gr



30x

-  Engate rápido para aspirador de óleo - Grupo FIAT
 Conector para aspirador de aceite - Grupo FIAT



REF		
9728	333gr	30x

-  Engate rápido para aspirador de óleo - VW
 Conector para aspirador de aceite - VW



REF		
9729	333gr	30x

-  Par cavaletes 3T c/ pino bloqueio
 Par de caballetes 3T con pin de seguridad



-  **Características:**
 Altura mínima: 290mm
 Altura máxima: 430mm
 Capacidade: 3T
 Dimensão da base: 205x185mm

-  **Características:**
 Altura mínima: 290mm
 Altura máxima: 430mm
 Capacidad: 3T
 Dimensión de la base: 205x185mm

REF				
4753	3T	290-430mm	6,7kg	1x

-  Par cavaletes 6T c/ pino bloqueio
 Par de caballetes 6T con pin de seguridad



-  **Características:**
 Altura mínima: 395mm
 Altura máxima: 625mm
 Capacidade: 6T
 Dimensão da base: 295x250mm

-  **Características:**
 Altura mínima: 395mm
 Altura máxima: 625mm
 Capacidad: 6T
 Dimensión de la base: 295x250mm

REF				
4756	6T	395-625mm	13,8kg	1x

 Cavalete de elevação 2T
 Caballete de elevación 2T



 **Características:**
Altura mínima: 1235mm
Altura máxima: 2130mm
Capacidade: 2T

 **Características:**
Altura mínima: 1235mm
Altura máxima: 2130mm
Capacidad: 2T

REF				
4842	2T	1235-2130mm	16kg	1x

 Cavalete de elevação 12T
 Caballete de elevación 12T



 **Características:**
Altura mínima: 805mm
Altura máxima: 1213mm
Capacidade: 12T

 **Características:**
Altura mínima: 805mm
Altura máxima: 1213mm
Capacidad: 12T

REF				
4843	12T	805-1213mm	27kg	1x

 Posicionador mecânico veículos 567kg
 Gato mecánico de posición del vehículo 567kg



 **Características:**
Carga nominal: 567kg
Largura útil: 320~720mm
Dimensão do rolo: Ø71,8x231,5mm
Dimensão da roda: Ø100x34mm

 **Características:**
Carga nominal: 567kg
Ancho útil: 320~720mm
Dimensión del rodillo: Ø71,8x231,5mm
Dimensión de la rueda: Ø100x34mm

REF		
8020	10,4kg	1x

-  Posicionador hidráulico veículos 680kg
 Gato hidráulico de posición del vehículo 680kg



-  **Características:**
 Carga nominal: 680Kg
 Largura útil: 340~620mm
 Dimensão do rolo: Ø70×230mm
 Dimensão da roda: Ø100×34mm

-  **Características:**
 Carga nominal: 680Kg
 Anchura utilizable: 340~620mm
 Dimensión del rodillo: Ø70×230mm
 Dimensión de la rueda: Ø100×34mm

REF



8021

17,5kg

2x

-  Posicionador veículos 816,5kg
 Gato de posición del vehículo 816,5kg



-  **Características:**
 Capacidade de peso: 816,5Kg
 Altura da base do bloco de pinças a partir do chão: 210-308mm
 Largura e altura do bloco de pressão: 0-25mm, 40mm
 Acolchoamento do bloco de pinça: Borracha

-  **Características:**
 Capacidad de peso: 816,5Kg
 Altura de la base del bloque desde el suelo: 210-308mm
 Anchura y altura del bloque de pellizco: 0-25mm, 40mm
 Acolchado del bloque de pellizco: Goma

REF



8022

19,4kg

1x

-  Separador de tractor 10T
 Separador de tractor 10T



-  **Características:**
 Capacidade: 10T (cada cavalete)
 Altura mínima: 520-620mm
 Altura máxima: 750-850mm
 Tamanho do carril: 600x4000mm
 Tamanho do suporte: 450x66mm
 Extensão: 100mm
 Tamanho da embalagem 1: 640*580*470mm
 Tamanho da embalagem 2: 640*580*470mm
 Tamanho da embalagem 3: 1035*680*280mm

-  **Características:**
 Capacidad: 10T (cada caballete)
 Altura mín.: 520-620mm
 Altura máx.: 750-850mm
 Tamaño del rail: 600x4000mm
 Tamaño del soporte: 450x66mm
 Extensión: 100mm
 Tamaño del embalaje 1: 640*580*470mm
 Tamaño del embalaje 2: 640*580*470 mm
 Tamaño del embalaje 3: 1035*680*280mm

REF



4857

10T

520-620/750-850mm

161kg

1x

 Estrado para mecânico plástico 48"
 Camilla plastica 48"

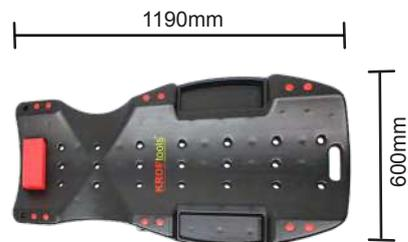

Roda / Rueda



REF 4873R

 **Características:**
Rodas com diâmetro 76mm em polipropileno PP
Estrutura HDPE de polipropileno de alta densidade
Dimensões: 1190x600x120mm
Peso máximo suporte: 200Kgs

 **Características:**
Ruedas con diámetro 76mm en polipropileno PP
Estructura HDPE polipropileno de alta densidade
Dimensiones: 1190x600x120mm
Peso máximo soporte: 200Kgs

REF			
4873	200kg	6kg	1x

 Estrado para mecânico plástico 40"
 Camilla mecanico 40"



Roda / Rueda



REF 4873R



 **Características:**
Baixo perfil
6 rodas giratórias
Resistente a óleo e solventes
Armazenamento de ferramenta incorporado
NOTA: Compatível com Rodas para Estrado Ref: 4873R

 **Características:**
Bajo perfil
6 ruedas giratorias
Resistente al aceite y a los disolventes
Almacenamiento de herramientas incorporado
NOTA: Compatible con Rueda para Camilla Mecánica Ref: 4873R

REF			
4876	200kg	4,6kg	1x

 Suporte segurança 2T p/ macaco rodas
 Soporte de seguridad 2T p/ gato de ruedas



 **Características:**
Carga: 2T
Comprimento: 230-380mm

 **Características:**
Carga: 2T
Longitud: 230-380mm

REF		
4757	1,45kg	10x

-  Tanque lavar peças 65L
 Tanque lavar piezas 65L

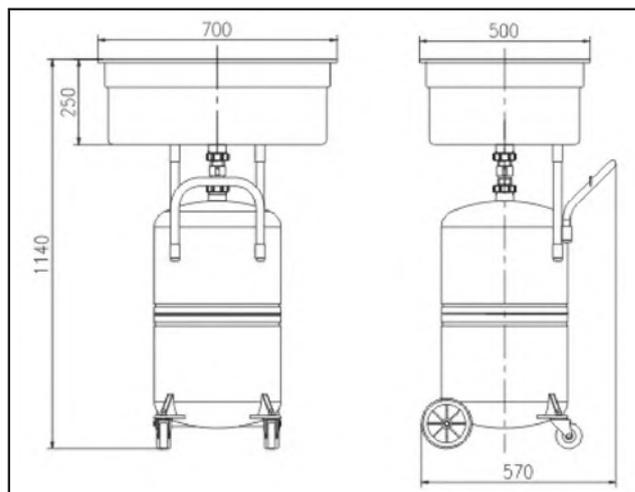

-  **Características:**
 Capacidade tanque: 65L
 Capacidade do tanque de lavagem: 50L
 Pressão máxima trabalho: 0,5 bar
 Quantidade de líquido necessária: 50L
 Pressão máxima pistola: 12L bar

-  **Características:**
 Capacidad del depósito: 65L
 Capacidad del depósito de lavado: 50L
 Presión máxima de trabajo: 0,5 bar
 Cantidad de líquido necesaria: 50L
 Presión máxima de la pistola: 12L bar

REF

9720



50kg



1x

-  Máquina de lavar peças elétrica 75L
 Lavadora de piezas eléctrica 75L

Produto de limpeza aconselhado:

- Um produto de limpeza e desengorduramento biodegradável concentrado à base de água, com as seguintes características
- Certificado NSF A1
- Facilmente biodegradável conforme OECD 301B
- Não contenha solventes de amónia, clorados ou petrolíferos
- Livre de fosfato, EDTA e nonilfenol
- Não inflamável
- PH neutro

Producto de limpieza recomendado:

- Producto limpiador y desengrasante concentrado biodegradable a base de agua, con las siguientes características:
- Certificado NSF A1
- Fácilmente biodegradable según OECD 301B
- No contienen amoniaco, disolventes clorados o derivados del petróleo
- Libre de fosfato, EDTA y nonilfenol
- No inflamable
- PH neutro

-  **Características:**
 Dimensões gerais: 790x537x880mm
 Dimensões tanque: 710x470x260mm
 Capacidade máxima solvente: 45L
 Potência máxima da bomba através da torneira
 Recircula: 2,7-3 litros/minuto de solvente
 Requisitos elétricos: (230V/50Hz)

-  **Características:**
 Dimensiones generales: 790x537x880mm
 Dimensiones tanque: 710x470x260mm
 Capacidad máxima solvente: 45L
 Salida máxima de la bomba a través del grifo
 Recircula: 2,7-3 litros/minuto de solvente
 Requisitos eléctricos: (230V/50Hz)

Pincel / Pincel



REF 9740P



REF

9740



25kg



1x

 Máquina de lavar peças elétrica 150L
 Lavadora de piezas eléctrica 150L



Pincel / Pincel



REF 9740P



Produto de limpeza aconselhado:

- Um produto de limpeza e desengorduramento biodegradável concentrado à base de água com as seguintes características:
- Certificado NSF A1
- Facilmente biodegradável conforme OECD 301B
- Não contenha solventes de amónia, clorados ou petrolíferos
- Livre de fosfato, EDTA e nonilfenol
- Não inflamável
- PH neutro

Producto de limpieza recomendado:

- Producto limpiador y desengrasante concentrado biodegradable a base de agua, con las siguientes características:
- Certificado NSF A1
- Fácilmente biodegradable según OECD 301B
- No contienen amoniaco, disolventes clorados o derivados del petróleo
- Libre de fosfato, EDTA y nonilfenol
- No inflamable
- PH neutro

 **Características:**

Dimensões gerais: 1135x547x880mm
Dimensões tanque: 1060x520x270mm
Capacidade tanque: 150L
Capacidade solvente: 90L
Capacidade máxima bomba: 2,7-3,3 L/min
Corrente elétrica: 120, 60hz / 230V, 50hz

 **Características:**

Dimensiones generales: 1135x547x880mm
Dimensiones tanque: 1060x520x270mm
Capacidad tanque: 150L
Capacidad solvente: 90L
Rendimiento máximo de la bomba: 2,7-3,3 L/min
Corriente eléctrica: 120, 60hz / 230V, 50hz

REF

9745



42kg



1x

 Máquina lavar peças a quente
 Lavadora de piezas con sistema de calentamiento



Produto de limpeza aconselhado:

- Um produto de limpeza e desengorduramento biodegradável concentrado à base de água, com as seguintes características:
- Certificado NSF A1
- Facilmente biodegradável conforme OECD 301B
- Não contenha solventes de amónia, clorados ou petrolíferos
- Livre de fosfato, EDTA e nonilfenol
- Não inflamável
- PH neutro

Producto de limpieza recomendado:

- Producto limpiador y desengrasante concentrado biodegradable a base de agua, con las siguientes características:
- Certificado NSF A1
- Fácilmente biodegradable según OECD 301B
- No contienen amoniaco, disolventes clorados o derivados del petróleo
- Libre de fosfato, EDTA y nonilfenol
- No inflamable
- PH neutro

 **Características:**

Dimensões gerais: 790mm (comprimento) x 610mm (largura) x 1710mm (altura)
Regulação da temperatura até 50°C
Pressão de lavagem: 70-120 PSI
Fluxo de circulação de lavagem: 0,8 litros/min
Área de trabalho: 736x558x452mm
Capacidade do solvente: 8-14L
Necessidade de ar: 70-120 PSI@5CFM

 **Características:**

Dimensiones totales: 790mm (largo) x 610mm (ancho) x 1710mm (alto)
Regulación de temperatura hasta 50°C
Presión de lavado: 70-120 PSI
Flujo de circulación de lavado: 0,8 litros/min
Área de trabajo: 736x558x452mm
Capacidad de disolvente: 8-14L
Requisitos de aire: 70-120 PSI@5CFM

REF

9775



46,6kg



1x

 Máquina decapar jato areia 40L
 Cabina chorreadora de arena 40L



 **Características:**
Dimensões gerais: 840x620x340mm
Comprimento mangueira: 2438mm
Consumo de Ar: 18.2 M³/h
Peso: 18kg
Diâmetro rodas: 145mm

 **Características:**
Dimensiones totales: 840x620x340mm
Longitud de la manguera: 2438mm
Consumo de aire: 18.2 M³/h
Peso: 18kg
Diámetro de las ruedas: 145mm

REF

9762



15kg



1x

 Máquina decapar jato areia 80L
 Cabina chorreadora de arena 80L



 **Características:**
Dimensões gerais: 700x380x840mm
Diâmetro rodas: 127mm (5")
Incluí mangueira 2.5m
Pressão de trabalho: 60-125 PSI
Consumo de ar: 18.2 M³/h

Especificações: Tanque com capacidade de 80L com válvula de bloqueio

 **Características:**
Dimensiones totales: 700x380x840mm
Diámetro de la rueda: 127mm (5")
Incluye manguera de 2.5m
Presión de trabajo: 60-125 PSI
Consumo de aire: 18.2 M³/h

Especificaciones: Tanque de 80L de capacidad con válvula de cierre

REF

9761



23kg



1x

 Máquina decapar jato de areia 90L

 Cabina chorreadora de arena 90L



Película protetora 400x0,3x300mm



REF 9765-01

Par de luvas / Par de guantes 9765



REF 9765-03

 **Características:**

Dimensões gerais: 630mm (comprimento) x 510mm (largura) x 493mm (altura)
Capacidade areia no funil: 6.5L
Entrada de ar: 40-80PSI@5CFM
Consumo de ar: 7.9 M³/h
Voltagem lâmpada: 12V
Potência: 4W±0.5W

 Utilizar com microesferas de vidro com granulagem 200-300

 **Características:**

Dimensiones generales: 630mm (longitud) x 510mm (anchura) x 493mm (altura)
Capacidad arena en embudo: 6.5L
Entrada de aire: 40-80PSI@5CFM
Consumo de aire: 7.9 M³/h
Voltaje lámpara: 12V
Potencia: 4W±0.5W

 Utilizar con microesferas de cristal granulación entre 200-300

REF

9765



17kg



1x

 Máquina decapar jato de areia 220L

 Cabina chorreadora de arena 220L



Película protetora 548x0,15x250mm



REF 9760-01

Par de luvas / Par de guantes 9760



REF 9760-02

 **Características:**

Dimensões gerais: 909mm (comprimento) x 635mm (largura) x 1389,5mm (altura)
Capacidade areia no funil: 33L
Entrada de ar: 40-80PSI@5CFM
Consumo de ar: 7.9 M³/h
Voltagem lâmpada: 12V
Potência: 4W±0.5W

 Utilizar com microesferas de vidro com granulagem 200-300

 **Características:**

Dimensiones generales: 909mm (longitud) x 635mm (anchura) x 1389,5mm (altura)
Capacidad de arena embudo: 33L
Entrada de aire: 40-80PSI@5CFM
Consumo de aire: 7.9 M³/h
Voltaje lámpara: 12V
Potencia: 4W±0.5W

 Utilizar con microesferas de cristal granulación entre 200-300

REF

9760



48kg



1x

 Máquina decapar jato de areia 350L
 Cabina chorreadora de arena 350L



Aspirador pó / Aspirador



REF 9770-56

Par de luvas / Par de guantes 9760



REF 9760-02

Película protetora
Película protetora

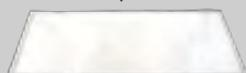

REF 9770PV

Película protetora vidro lâmpada
Película protetora visor lampara



REF 9770PL



 **Características:**
Dimensões gerais: 1050mm (comprimento) x 1230mm (largura) x 1670mm (altura)
Pressão de ar: 60PSI-120PSI
Entrada de ar: 7.9 M³/h
Capacidade da areia funil: 40L
Voltagem: 230V / 50HZ
Tensão de saída: 12V

 Utilizar com microesferas de vidro com granulagem 200-300

 **Características:**
Dimensiones totales: 1050mm (longitud) x 1230mm (anchura) x 1670mm (altura)
Presión de aire: 60PSI-120PSI
Consumo de aire: 7.9 M³/h
Capacidad de arena embudo: 40L
Voltaje: 230V / 50HZ
Voltaje de salida: 12V

 Utilizar con microesferas de cristal granulación entre 200-300

REF
9770

90kg

1x

Máquina decapar jato de areia 990L
Cabina chorreadora de areia 990L



Película protetora
Película protetora



REF 9772PV

Película protetora vidro lâmpada
Película protetora visor lampara



REF 9772PL

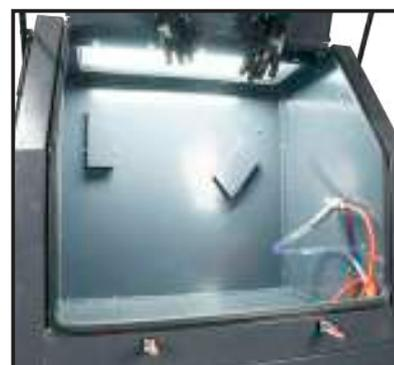

Aspirador pó/ Aspirador



REF 9770-56

Par de luvas / Par de guantes 9760



REF 9760-02

Pistola areia / Pistola chorreadora



REF 9773



Tamanho do bocal	Pressão de trabalho (psi)	Consumo de ar		Taxa de Produção de Areia (kg/min)
		M3/h	L/min	
Φ6	60	9	150	1.0kg/min
	100	11	183.3	0.8kg/min
	120	12.8	213.3	0.6kg/min
Φ7	60	9	150	1.2kg/min
	100	11	183.3	1.6kg/min
	120	12.8	213.3	1.2kg/min

Tamaño Boquilla	Presión de trabajo (psi)	Consumo de aire		Índice de Producción de Arena (kg/min)
		M3/h	L/min	
Φ6	60	9	150	1.0kg/min
	100	11	183.3	0.8kg/min
	120	12.8	213.3	0.6kg/min
Φ7	60	9	150	1.2kg/min
	100	11	183.3	1.6kg/min
	120	12.8	213.3	1.2kg/min

Características:
Dimensões gerais: 1323mm (comprimento) x 1195mm (largura) x 1769mm (altura)
Potência motor: 1200W
Voltagem: 220~240V / 50HZ

Utilizar com microesferas de vidro com granulagem entre 200-300

Características:
Dimensiones generales: 1323 mm (largura) x 1195 mm (ancho) x 1769 mm (alto)
Potencia motor: 1200W
Voltaje: 220~240V / 50HZ

Utilizar con microesferas de cristal granulación entre 200-300

REF
9771

160kg

1x

Máquina decapar jato de areia 1200L
Cabina chorreadora de arena 1200L



Aspirador pó / Aspirador



REF 9770-56

Par de luvas / Par de guantes 9760



REF 9760-02

Pistola areia / Pistola chorreadora



REF 9773

Película protetora / Película protetora



REF 9772PV

Película protetora vidro lâmpada
Película protetora visor lampara



REF 9772PL

Tamanho do bocal	Pressão de trabalho (psi)	Consumo de ar		Taxa de Produção de Areia (kg/min)
		M3/h	L/min	
Φ6	60	9	150	1.0kg/min
	100	11	183.3	0.8kg/min
	120	12.8	213.3	0.6kg/min
Φ7	60	9	150	1.2kg/min
	100	11	183.3	1.6kg/min
	120	12.8	213.3	1.2kg/min

Tamaño Boquilla	Presión de trabajo (psi)	Consumo de aire		Índice de Producción de Arena (kg/min)
		M3/h	L/min	
Φ6	60	9	150	1.0kg/min
	100	11	183.3	0.8kg/min
	120	12.8	213.3	0.6kg/min
Φ7	60	9	150	1.2kg/min
	100	11	183.3	1.6kg/min
	120	12.8	213.3	1.2kg/min

Características:
Dimensões gerais: 1524mm (comprimento) x 1399mm (largura) x 1839mm (altura)
Capacidade de carregamento de areia: 32L
Motor: 220~240V 50Hz 1200W

Utilizar com microesferas de vidro com granulação entre 200-300

Características:
Dimensiones totales: 1524mm (longitud) x 1399mm (anchura) x 1839mm (altura)
Capacidad de carga de arena: 32L
Motor: 220 ~ 240V 50Hz 1200W

Utilizar con microesferas de cristal granulación entre 200-300

REF
9772

200kg

1x

-  Pistola jato areia com bocais 4/5/6/7mm
-  Pistola chorreadora arena con boquillas 4/5/6/7mm



 **Medidas:** 4/5/6/7mm
Compatível com a REF 9760, 9765, 9770

 **Medidas:** 4/5/6/7mm
Compatible con el REF 9760, 9765, 9770

REF		
9769	1kg	50x

-  Kit 4 bocais para pistola jato areia 4/5/6/7mm
-  Juego 4 boquillas para pistola chorreo arena 4/5/6/7mm



 **Medidas:** 4/5/6/7mm
Compatível com a REF 9769

 **Medidas:** 4/5/6/7mm
Compatible con el REF 9769

REF		
9766	867gr	150x

-  Pistola jato areia com bocais 2/2.5/3/3.5mm
-  Pistola chorreadora arena con boquillas 2/2.5/3/3.5mm



 **Medidas:** 2/2.5/3/3.5mm
Compatível com a REF 9761, 9762

 **Medidas:** 2/2.5/3/3.5mm
Compatible con el REF 9761, 9762

REF		
9768	1kg	1x

-  Kit 4 bocais para pistola jato areia 2/2.5/3/3.5mm
-  Juego 4 boquillas para pistola chorreo arena 2/2.5/3/3.5mm



 **Medidas:** 2/2.5/3/3.5mm
Compatível com a REF 9768

 **Medidas:** 2/2.5/3/3.5mm
Compatible con el REF 9768

REF		
9767	867gr	200x

-  Pistola jato areia para máquinas 990L e 1200L
-  Pistola chorreadora arena para para 990L y 1200L



 **Características:**
Quantidade mínima de ar: 7,1 CFM @ 90 PSI
Requisitos ideais de funcionamento: 10,25 CFM @ 115PSI
Pressão máxima de funcionamento: 120PSI

 **Características:**
Cantidad mínima de aire: 7,1 CFM @ 90 PSI
Requisitos de funcionamiento ideales: 10,25 CFM @ 115PSI
Presión máxima de funcionamiento: 120PSI

REF		
9773	300gr	1x

-  Kit 4 bocais para máquinas jato de areia 6/7mm
-  Kit 4 piezas boquillas para chorreadora 6/7mm



 **Medidas:** 6/6/7/7mm
Compatível com a REF 9773

 **Medidas:** 6/6/7/7mm
Compatible con el REF 9773

REF		
9774	200gr	250x

-  Desmontador pneus automático 380V
 Desmontadora de ruedas automática 380V



 **Características:**

Fixação de aro externa: 12"-24"
 Fixação de aro Interna: 13"-26"
 Largura máxima do pneu: 14"
 Diâmetro máximo do pneu: 1120mm (44")
 Pressão de trabalho: 8bar-10bar (145 Psi)
 Pressão de enchimento máxima: 3.5bar
 Voltagem: 380V (3ph)
 Potência: 0.75/1.1kw
 Velocidade de rotação da plataforma giratória: 7 r/min
 Torque máximo do eixo: 1200Nm~1500Nm
 Força de desmontagem: 2500Kg
 Dimensão da máquina: 1600x1600x1990mm
 Nível de ruído: <75dB (A)

 **Características:**

Rango de sujeción exterior: 12"-24"
 Rango de sujeción interior: 13"-26"
 Anchura máxima de la rueda: 14"
 Diámetro máximo de la rueda: 1120mm (44")
 Presión de trabajo: 8bar-10bar (145 Psi)
 Presión máxima de llenado: 3.5bar
 Voltaje: 380V (3ph)
 Potencia: 0.75/1.1kw
 Velocidad de rotación de la plataforma giratoria: 7 r/min
 Torque máximo del eje: 1200Nm~1500Nm
 Fuerza destalonadora: 2500Kg
 Tamaño de la máquina: 1600x1600x1990mm
 Nivel de ruido: <75dB (A)

REF

9016



250kg



1x

- Desmontador pneus automático 220V
- Desmontadora de ruedas automática 220V

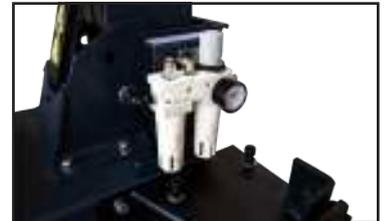

Características:

Fixação de aro Externa: 12"-24"
 Fixação de aro Interna: 13"-26"
 Largura máxima do pneu: 14"
 Diâmetro máximo do pneu: 1120mm (44")
 Pressão de trabalho: 8bar-10bar (145 Psi)
 Pressão de enchimento máxima: 3.5bar
 Voltagem: 220V (1ph)
 Potência: 0.75/1.1kw
 Velocidade de rotação da plataforma giratória: 7 r/min
 Torque máximo do eixo: 1200Nm~1500Nm
 Força de desmontagem: 2500Kg
 Dimensão da máquina: 1600x1600x1990mm
 Nível de ruído: <75dB (A)

Características:

Rango de sujeción exterior: 12"-24"
 Rango de sujeción interior: 13"-26"
 Anchura máxima de la rueda: 14"
 Diámetro máximo de la rueda: 1120mm (44")
 Presión de trabajo: 8bar-10bar (145 Psi)
 Presión máxima de llenado: 3.5bar
 Voltaje 220V (1ph)
 Potencia 0.75/1.1kw
 Velocidad de rotación de la plataforma giratoria 7 r/min
 Torque máximo del eje 1200Nm~1500Nm
 Fuerza destalonadora 2500Kg
 Tamaño de la máquina 1600x1600x1990mm
 Nivel de ruido <75dB (A)

REF
9017

250kg

1x

-  Braço runflat para desmontador pneus
 Brazo runflat para desmontadora de ruedas



 **Descrição:**
 O objetivo do braço Runflat para desmontadora de pneus é, ajudar na remoção ou instalação de pneus Runflat que são difíceis de montar/desmontar e melhorar a eficiência da máquina na substituição de pneus

Dimensões: 1280x470x420mm

 **Descripción:**
 La finalidad del brazo para neumáticos planos de una desmontadora de neumáticos es ayudar a desmontar o instalar neumáticos planos difíciles de montar/desmontar y mejorar la eficacia de la máquina al cambiar los neumáticos

Dimensiones: 1280x470x420mm

REF
9018

76kg

1x

Kit 9016+9018
Juego 9016+9018



9016 - Características:

Fixação de aro externa: 12"-24"
Fixação de aro Interna: 13"-26"
Largura máxima do pneu: 14"
Diâmetro máximo do pneu: 1120mm (44")
Pressão de trabalho: 8bar-10bar (145 Psi)
Pressão de enchimento máxima: 3.5bar
Voltagem: 380V (3ph)
Potência: 0.75/1.1kw
Velocidade de rotação da plataforma giratória: 7 r/min
Torque máximo do eixo: 1200Nm~1500Nm
Força de desmontagem: 2500Kg
Dimensão da máquina: 1600x1600x1990mm
Nível de ruído: <75dB (A)

9018 - Descrição:

O objetivo do braço Runflat para desmontadora de pneus é, ajudar na remoção ou instalação de pneus Runflat que são difíceis de montar/desmontar e melhorar a eficiência da máquina na substituição de pneus

Dimensões: 1280x470x420mm

9016 - Características:

Rango de sujeción exterior: 12"-24"
Rango de sujeción interior: 13"-26"
Anchura máxima de la rueda: 14"
Diámetro máximo de la rueda: 1120mm (44")
Presión de trabajo: 8bar-10bar (145 Psi)
Presión máxima de llenado: 3.5bar
Voltaje: 380V (3ph)
Potencia: 0.75/1.1kw
Velocidad de rotación de la plataforma giratoria: 7 r/min
Torque máximo del eje: 1200Nm~1500Nm
Fuerza destalonadora: 2500Kg
Tamaño de la máquina: 1600x1600x1990mm
Nivel de ruido: <75dB (A)

9018 - Descripción:

La finalidad del brazo para neumáticos planos de una desmontadora de neumáticos es ayudar a desmontar o instalar neumáticos planos difíciles de montar/desmontar y mejorar la eficacia de la máquina al cambiar los neumáticos

Dimensiones: 1280x470x420mm

REF

KIT90169018



326kg



1x



Kit 9017+9018



Juego 9017+9018

**9017 - Características:**

Fixação de aro Externa: 12"-24"
 Fixação de aro Interna: 13"-26"
 Largura máxima do pneu: 14"
 Diâmetro máximo do pneu: 1120mm (44")
 Pressão de trabalho: 8bar-10bar (145 Psi)
 Pressão de enchimento máxima: 3.5bar
 Voltagem: 220V (1ph)
 Potência: 0.75/1.1kw
 Velocidade de rotação da plataforma giratória: 7 r/min
 Torque máximo do eixo: 1200Nm~1500Nm
 Força de desmontagem: 2500Kg
 Dimensão da máquina: 1600x1600x1990mm
 Nível de ruído: <75dB (A)

9018 - Descrição:

O objetivo do braço Runflat para desmontadora de pneus é, ajudar na remoção ou instalação de pneus Runflat que são difíceis de montar/desmontar e melhorar a eficiência da máquina na substituição de pneus

Dimensões: 1280x470x420mm

**9017 - Características:**

Rango de sujeción exterior: 12"-24"
 Rango de sujeción interior: 13"-26"
 Anchura máxima de la rueda: 14"
 Diámetro máximo de la rueda: 1120mm (44")
 Presión de trabajo: 8bar-10bar (145 Psi)
 Presión máxima de llenado: 3.5bar
 Voltaje: 220V (1ph)
 Potencia: 0.75/1.1kw
 Velocidad de rotación de la plataforma giratoria: 7 r/min
 Torque máximo del eje: 1200Nm~1500Nm
 Fuerza destalonadora: 2500Kg
 Tamaño de la máquina: 1600x1600x1990mm
 Nivel de ruido: <75dB (A)

9018 - Descripción:

La finalidad del brazo para neumáticos planos de una desmontadora de neumáticos es ayudar a desmontar o instalar neumáticos planos difíciles de montar/desmontar y mejorar la eficacia de la máquina al cambiar los neumáticos

Dimensiones: 1280x470x420mm

REF

KIT90179018



326kg



1x

-  Desmontador pneus automático 380V 12"-24" 1 vel.
-  Desmontadora de ruedas automática 380V 12"-24" 1 vel.



-  **Características:**
 Tamanho da jante exterior: 10"-22"
 Tamanho da jante interior: 12"-24"
 Largura máxima do pneu: 13"
 Diâmetro máximo da roda: 1000mm (39")
 Pressão de trabalho: 10 bar (145 Psi)
 Pressão de enchimento máxima: 3.5 bar
 Voltagem: 380V (3ph)
 Potência: 0.75/1.1kw
 Velocidade de rotação do prato giratório: 7 r/min
 Binário máximo do eixo: 1200Nm~1500Nm
 Pressão do martelo demolidor: 2500kg
 Tamanho da máquina: 1600x1450x1870
 Nível de ruído: <750dB(A)

-  **Características:**
 Tamaño exterior de la llanta de la abrazadera: 10"-22"
 Tamaño interior de la llanta de la abrazadera: 12"-24"
 Anchura máxima del neumático: 13"
 Diámetro máximo de rueda: 1000mm (39")
 Presión de trabajo: 10 bar (145 Psi)
 Presión máxima de inflado: 3.5 bar
 Voltaje: 380V (3ph)
 Potencia: 0.75/1.1kw
 Velocidad de rotación de la plataforma giratoria: 7 r/min
 Par máximo del eje: 1200Nm~1500Nm
 Presión del destalonador: 2500kg
 Tamaño de la máquina: 1600x1450x1870
 Nivel de ruido: <750dB(A)

REF

9046



222kg



1x

-  Desmontador pneus automático 220V 12"-24" 1 vel.
-  Desmontadora de ruedas automática 220V 12"-24" 1 vel.



-  **Características:**
 Tamanho da jante exterior: 10"-22"
 Tamanho da jante interior: 12"-24"
 Largura máxima do pneu: 13"
 Diâmetro máximo da roda: 1000mm (39")
 Pressão de trabalho: 10 bar (145 Psi)
 Pressão de enchimento máxima: 3.5 bar
 Voltagem: 220V (3ph)
 Potência: 0.75/1.1kw
 Velocidade de rotação do prato giratório: 7 r/min
 Binário máximo do eixo: 1200Nm~1500Nm
 Pressão do martelo demolidor: 2500kg
 Tamanho da máquina: 1600x1450x1870
 Nível de ruído: <750dB(A)

-  **Características:**
 Tamaño exterior de la llanta de la abrazadera: 10"-22"
 Tamaño interior de la llanta de la abrazadera: 12"-24"
 Anchura máxima del neumático: 13"
 Diámetro máximo de rueda: 1000mm (39")
 Presión de trabajo: 10 bar (145 Psi)
 Presión máxima de inflado: 3.5 bar
 Voltaje: 220V (3ph)
 Potencia: 0.75/1.1kw
 Velocidad de rotación de la plataforma giratoria: 7 r/min
 Par máximo del eje: 1200Nm~1500Nm
 Presión del destalonador: 2500kg
 Tamaño de la máquina: 1600x1450x1870
 Nivel de ruido: <750dB(A)

REF

9047



222kg



1x

-  Desmontador pneus semi-automático c/ braço fixo 220V
 Desmontadora neumáticos Semi-automática c/braço fixo 220V

 **Características:**

Desmontador Semi-Automático de Pneus
 Fixação de aro Externa: 12"~21"
 Fixação de aro Interna: 10"~19"
 Máx. Diâmetro da roda: 960mm
 Máx. Largura de roda: 3"~15"
 Força de Desacoplamento: 2700kg
 Pressão de funcionamento: 8~10 bar
 Fornecimento de energia: 220V/50Hz/1Ph, 1.1kW
 Temperatura de trabalho: 0-45°C

 **Características:**

Desmontadora semiautomática de neumáticos
 Rango de sujeción exterior: 12"~21"
 Rango de sujeción interior: 10"~19"
 Max. Diámetro de la rueda: 960mm
 Ancho máx. de la rueda: 3"~15"
 Fuerza destalonadora: 2700kg
 Presión de trabajo: 8~10 bar
 Fuente de alimentación: 220V/50Hz/1Ph, 1.1kW
 Temperatura de trabajo: 0-45°C

REF

9021



156kg



1x

Máquina calibrar rodas 14"-26" 220V
Equilibradora ruedas 14"-26"



Características:

Peso máximo da roda: 200Kg
Potência: 0.55kw
Fonte de alimentação: 220V 60Hz 1Ph
Precisão de balanceamento: $\pm 10g$
8 modos de balanceamento: DYN, ALU1, ALU2, ALU3, ALU4, ALU5, ALUS, ST
Velocidade de balanceamento: 200r/min
Tempo de ciclo: 30s
Diâmetro da jante: 14"~26"
Nível de pressão sonora durante o ciclo de trabalho: <70db
Para veículos pesados

Características:

Peso máximo de la rueda: 200Kg
Potencia: 0.55kw
Alimentación: 220V 60Hz 1Ph
Precisión de equilibrado: $\pm 10g$
8 modos de equilibrado: DYN, ALU1, ALU2, ALU3, ALU4, ALU5, ALUS, ST
Velocidad de equilibrado: 200r/min
Tiempo de ciclo: 30s
Diámetro de la llanta: 14"~26"
Nivel de presión sonora durante el ciclo de trabajo: <70db
Para vehículos pesados

REF

9032



230kg



1x

 Máquina calibrar rodas camião 13"-24"
 Equilibradora ruedas camión 13"-24"



 **Características:**
 Diâmetro da jante: 13"-24"
 Largura da jante: 5.5"-20"
 Peso máximo da roda: 150kg
 Largura máxima da roda: 1200mm
 Pressão de ar: 6-8bar
 Tempo de teste: 8s
 Cobertura de proteção: fornecida
 Elevador pneumático incorporado: fornecido
 Dimensões totais (aproximadamente): 2000 x 1500mm

 **Características:**
 Diámetro de la llanta: 13" - 24"
 Anchura de la llanta: 5.5" - 20"
 Peso máximo de la rueda: 150kg
 Anchura máxima de la rueda: 1200mm
 Presión de aire: 6-8bar
 Tiempo de prueba: 8s
 Cubierta protectora: suministrada
 Elevador neumático incorporado: suministrado
 Dimensiones totales (aproximadas): 2000 x 1500mm

REF

9039



250kg



1x

 Máquina calibrar rodas automático 10"-24" c/ laser e LCD 21"
 Equilibradora ruedas automática 10"-24" con laser y 21" LCD



 **Características:**
 Peso máximo da roda: 65 kg
 Potência: 0.2kw; 0.37kw
 Fonte de alimentação: 220v; 230v; 240v; 110v; 50hz; 60hz
 Precisão de balanceamento: +1g
 9 modos de balanceamento: DYN, ALU1, ALU2, ALU3, ALU4, ALU5, ALU-S1, ALU-S2, ST
 Velocidade de equilíbrio: 200r/min
 Tempo de ciclo: 8s
 Diâmetro da jante: 1024" (256mm- 610mm)
 Nível de pressão sonora durante o ciclo de trabalho: <70db

 **Características:**
 Peso máximo de las ruedas: 65kg
 Potencia: 0.2kw; 0.37kw
 Alimentación: 220v; 230v; 240v; 110v; 50hz; 60hz
 Equilibrar la precisión: +1g
 9 modos de equilibrado: DYN, ALU1, ALU2, ALU3, ALU4, ALU5, ALU-S1, ALU-S2, ST
 Equilibrar la velocidad: 200r/min
 Duración del ciclo: 8s
 Diámetro de la llanta: 1024" (256mm- 610mm)
 Nivel de presión sonora durante el ciclo de trabajo: <70db

REF

9048



110kg



1x

 Máquina calibrar rodas semi-automática 10"-24"

 Equilibradora ruedas semi-automática 10"-24"



Diâmetro: 36mm
Diámetro: 36mm

 **Características:**

Peso máximo da roda: 65kg
Potência: 0,25kw
Diâmetro do veio: 36mm
Fonte de alimentação: 220v; 50hz
Precisão de balanceamento: 1g
8 modos de balanceamento: DYN, ALU1, ALU2, ALU3, ALUS, ST
Velocidade de balanceamento: 200r/min
Tempo de ciclo: 8s
Diâmetro do aro: 10~24" (256mm~610mm)
Nível de pressão sonora durante o ciclo de trabalho: <70db

NOTA: Compatível com Jogo garras de moto p/ máquina calibrar pneus - modelo 9022, Ref: 9028

 **Características:**

Peso máximo de las ruedas: 65 kg
Potencia: 0,25kw
Diámetro eje: 36mm
Alimentación: 220v; 50hz
Precisión de equilibrado: 1g
8 modos de equilibrado: DYN, ALU1, ALU2, ALU3, ALUS, ST
Velocidad de equilibrado: 200r/min
Tiempo de ciclo: 8s
Diámetro de la llanta: 10~24" (256mm~610mm)
Nivel de presión sonora durante el ciclo de trabajo: <70db

NOTA: Compatible con Juego garras moto para equilibradora ruedas - modelo 9022, Ref: 9028

REF

9022



95kg



1x

 Máquina calibrar rodas automático 10"-24"

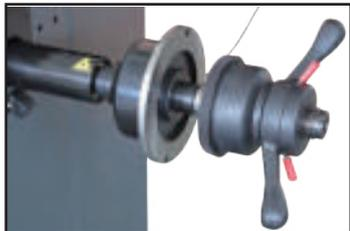
 Equilibradora ruedas automática 10"-24"

 Diámetro: 40mm
 Diámetro: 40mm

Características:

Peso máximo da roda: 65Kg
 Diâmetro do veio: 40mm
 Potência: 0.25kw
 Fonte de alimentação: 220v; 50-60hz
 Precisão de balanceamento: $\pm 1g$
 8 modos de balanceamento: DYN, ALU1, ALU2, ALU3, ALU4, ALU5, ALUS, ST
 Velocidade de equilíbragem: 200r/min
 Tempo de ciclo: 8s
 Diâmetro da jante: 10" ~ 24" (256mm~610mm)
 Nível de pressão sonora durante o ciclo de trabalho: <70db

Características:

Peso máximo de la rueda: 65kg
 Diámetro eje: 40mm
 Potencia: 0.25kw
 Fuente de alimentación: 220v; 50-60hz
 Precisión de equilibrado: $\pm 1g$
 8 modos de equilibrado: DYN, ALU1, ALU2, ALU3, ALU4, ALU5, ALUS, ST
 Velocidad de equilibrado: 200r/min
 Tiempo de ciclo: 8s
 Diámetro de la llanta: 10" ~ 24" (256mm~610mm)
 Nivel de presión sonora durante el ciclo de trabajo: <70db

REF

9045



90kg



1x

 Talonador pneus pneumático 18L
 Talonador de cubiertas para neumáticos 18L



 **Características:**
Capacidade do depósito: 0-18L
Pressão de funcionamento: 3 ÷ 8bar
Pressão máxima do depósito: 16bar

 **Características:**
Capacidad del depósito: 0-18L
Presión de funcionamiento: 3 ÷ 8bar
Presión máxima del depósito: 16bar

REF

9033



5,2kg



1x

 Talonador pneus pneumático 36L
 Talonador de cubiertas para neumáticos 36L



 **Características:**
Capacidade do depósito: 0-36L
Pressão de funcionamento: 3 ÷ 8bar
Pressão máxima do depósito: 24bar

 **Características:**
Capacidad del depósito: 0-36L
Presión de funcionamiento: 3 ÷ 8bar
Presión máxima del depósito: 24bar

REF

9034



6,8kg



1x

 Talonador pneus pneumático 19L com suporte para 9016/9017
 Talonador de cubiertas para neumáticos 19L con soporte para 9016/9017

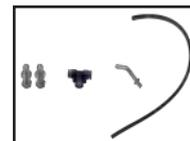

 **Características:**
Capacidade: 19L
Pressão de trabalho: 0.8-1.0MPa
Dimensões: 450x400mm

 **Características:**
Capacidad: 19L
Presión de trabajo: 0.8-1.0MPa
Dimensiones: 450x400mm

REF

9035



10kg



1x

 Alicete de pesos
 Alicate de peso



 **Comprimento:** 250mm

 **Longitud:** 250mm

REF



9002-07

300gr

1x

 Jogo garras de moto para desmontador pneus
 Juego garras moto para desmontadora de neu máticos



 **Características:**

Aperto externo: 6"-24", Aperto interno: 8"-26"
 Largura máxima da roda: 12"; Diâmetro máximo da roda: 39"
 Para usar com a desmontadora de pneus:
 - REF 9016, 9017, 9046, 9047, 9021

 **Características:**

Apriete externo: 6"-24", Apriete interno: 8"-26"
 Ancho máximo de la rueda: 12"; Diámetro máximo de la rueda: 39"
 Para usar con el cambiador de neumáticos:
 - REF 9016, 9017, 9046, 9047, 9021

REF



9004

4kg

1x

 Adaptador para jantes cegas
 Adaptador para llanta ciega



 **Características:**

Diâmetro do eixo: 40mm (φ40)
 Para REF 9012

 **Características:**

Diámetro del eje: 40mm (φ40)
 Para REF 9012

REF



9009

5kg

1x

 Adaptador universal para jantes cegas - veio 36mm
 Adaptador universal para llanta ciega ø36



 **Características:**

Diâmetro do eixo: 36mm (φ36)
 Para REF 9022

 **Características:**

Diámetro del eje: 36mm (φ36)
 Para REF 9022

REF



9029

3kg

1x

 Jogo de garras de moto para balanceadora pneus
 Juego de garras moto para calibradora de ruedas

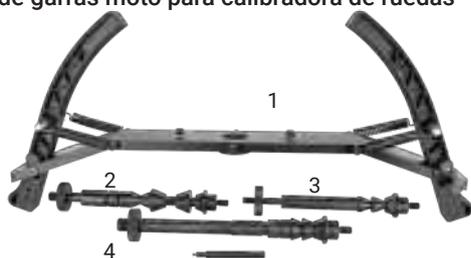

 **Características:** Diâmetro da roda: 10"-24"

Para usar com a máquina calibrar rodas REF 9012

Medidas: 1 - Diâmetro encaixe: 29mm, 2 - Fuso 14mm / rosca 10mm
 3 - Fuso 10mm / rosca 10mm; 4 - 18mm / rosca 10mm

 **Características:** Diámetro de la rueda: 10"-24"

Para usar con calibrador de ruedas REF 9012

Medidas: 1 - Diámetro enchufe: 29mm, 2 - Husillo 14mm / rosca 10mm; 3 - eje 10mm / rosca 10mm; 4 - Husillo 18 mm / rosca 10mm

REF



9005

3,5kg

1x

 Kit 4pcs protetor jantes veículos industriais
 Kit de 4pzs protectores de rueda para vehículos industriales



 **Material:** Fundição em liga de alumínio e magnésio
NOTA: Usado para proteção da jante de alumínio ao usar a desmontadora de pneus
 **Material:** Fundición a presión aleación de aluminio y magnesio
NOTA: Se utiliza para la protección de la llanta de aluminio cuando se utiliza la desmontadora de neumáticos

REF		
9036	5kg	1x

 Kit 4pcs aros proteção jantes alumínio
 Kit de 4pzs de llanta de aluminio



 **Material:** Alumínio
Diâmetro: $\Phi 175/\Phi 201/\Phi 220/\Phi 280$
NOTA: Utilizado para proteção da jante de alumínio quando se utiliza a desmontadora de pneus
 **Material:** Aluminio
Diámetro: $\Phi 175/\Phi 201/\Phi 220/\Phi 280$
NOTA: Se utiliza para la protección de la llanta de aluminio cuando se utiliza la desmontadora de neumáticos

REF		
9037	10kg	1x

 Kit cone 121-174mm e flange diâmetro 36mm
 Kit cono 121-174mm e brida 188mm diâmetro 36mm



 **Descrição:** Este kit destina-se a equilibrar as rodas dos 4x4 e carrinhas
A flange de 188mm é utilizada para separar a jante do corpo da máquina de equilibrar
O cone varia entre 121-174 mm, para a utilização nas rodas de 4x4 e de pequenos camiões
 **Descripción:** Este kit está diseñado para equilibrar las ruedas de 4x4 y furgonetas
La brida de 188mm se utiliza para separar la llanta del cuerpo de la equilibradora
El cono varía entre 121-174 mm, para su uso en las ruedas de 4x4 y camiones pequeños

REF		
9038	6,5kg	1x

 Caixa pesos p/ jante ferro 5g 100pcs
 Contrapesa llanta hierro 5g 100pzs



 **Características:** Pesos de roda com clip de zinco e revestimento cinzento para jantes de aço
 **Características:** Contrapesos de rueda con clip de zinc y revestimiento gris para llanta de acero

REF		
9050	500gr	16x

 Caixa pesos p/ jante ferro 10g 100pcs
 Contrapesa llanta hierro 10g 100pzs



 **Características:** Pesos de roda com clip de zinco e revestimento cinzento para jantes de aço
 **Características:** Contrapesos de rueda con clip de zinc y revestimiento gris para llanta de acero

REF		
9051	1kg	8x

-  Caixa pesos p/ jante ferro 15g 100pcs
 Contrapesa llanta hierro 15g 100pzs



 **Características:** Pesos de roda com clip de zinco e revestimento cinzento para jantes de aço

 **Características:** Contrapesos de rueda con clip de zinc y revestimiento gris para llanta de acero

REF		
9052	1,5kg	8x

-  Caixa pesos p/ jante ferro 20g 100pcs
 Contrapesa llanta hierro 20g 100pzs



 **Características:** Pesos de roda com clip de zinco e revestimento cinzento para jantes de aço

 **Características:** Contrapesos de rueda con clip de zinc y revestimiento gris para llanta de acero

REF		
9053	2kg	8x

-  Caixa pesos p/ jante ferro 30g 100pcs
 Contrapesa llanta hierro 30g 100pzs



 **Características:** Pesos de roda com clip de zinco e revestimento cinzento para jantes de aço

 **Características:** Contrapesos de rueda con clip de zinc y revestimiento gris para llanta de acero

REF		
9054	3kg	8x

-  Caixa pesos p/ jante ferro 45g 50pcs
 Contrapesa llanta hierro 45g 50pzs



 **Características:** Pesos de roda com clip de zinco e revestimento cinzento para jantes de aço

 **Características:** Contrapesos de rueda con clip de zinc y revestimiento gris para llanta de acero

REF		
9055	2,25kg	8x

Caixa pesos adesivos zincados 5g*12 100pcs
Contrapesa adhesiva zinc 5g*12 100pzs



Características: Pesos adesivos de aço 5g*12 zincado

Características: Pesos adhesivos de acero 5g*12 zincado

REF

9056



6kg



4x

Caixa pesos adesivos 5g*12 100pcs
Contrapesa adhesiva 5g*12 100pzs



Características: Pesos adesivos de aço 5g*12 revestido a cinzento

Características: Pesos adhesivos de acero 5g*12 con revestimiento gris

REF

9057



6kg



4x

Caixa pesos adesivos zincados (5+10)g*4 100pcs
Contrapesa adhesiva zinc (5+10)g*4 100pzs



Características: Pesos adesivos de aço (5+10)g*4 zincado

Características: Pesos adhesivos de acero (5+10)g*4 zincado

REF

9058



6kg



4x

Caixa pesos adesivos (5+10)g*4 100pcs
Contrapesa adhesiva (5+10)g*4 100pzs



Características: Pesos adesivos de aço (5+10)g*4 revestido a cinzento

Características: Pesos adhesivos de acero (5+10)g*4 con revestimiento gris

REF

9059



6kg



4x



Desmontadora pneus 14-26" 380V

Desmontadora de neumáticos 14-26" 380V

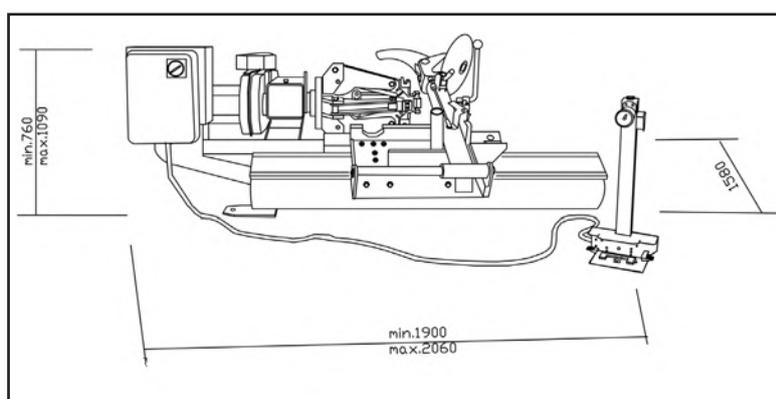
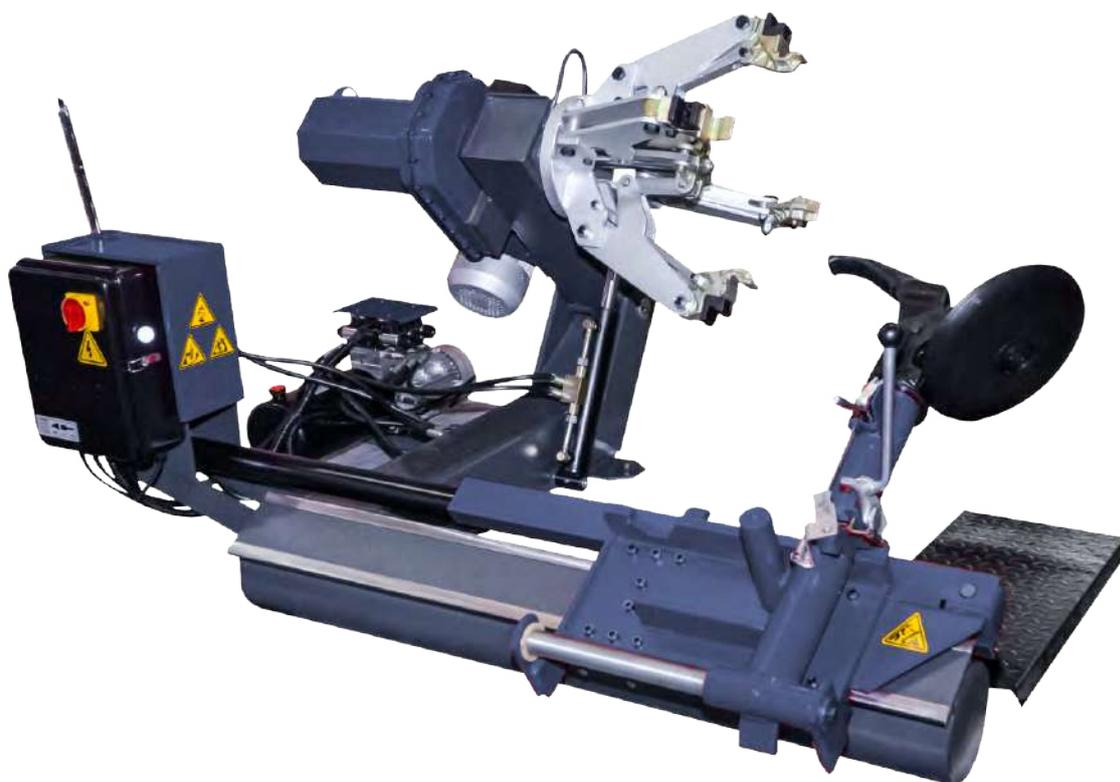
Características:

Diâmetro: 14 "-26"
 Máxima largura da roda: 780 mm
 Máximo diâmetro da roda: 1600 mm
 Máximo peso da roda: 500 kg
 Motor da bomba hidráulica: 1,5 KW
 Motor engrenagem: 2.2 KW
 Força do desagregador do grânulo: 8-10 bar
 Fonte de alimentação: 380 V
 Nível de pressão acústica (no trabalho): LPA <70dB(A)

Características:

Diámetro: 14 "-26"
 Máximo ancho de rueda: 780 mm
 Máximo diámetro de la rueda: 1600 mm
 Máximo peso de la rueda: 500 kg
 Motor bomba hidráulica: 1,5 W
 Motor caja de cambios: 2,2 W
 Fuerza del destalonador: 8-10 bar
 Fuente de alimentación: 380 V
 Nivel de presión acústica (en el trabajo): LPA <70dB(A))

REF
9007

570kg

1x

-  Desmontadora pneus 14-56" 380V
-  Desmontadora de neumáticos 14-56" 380v

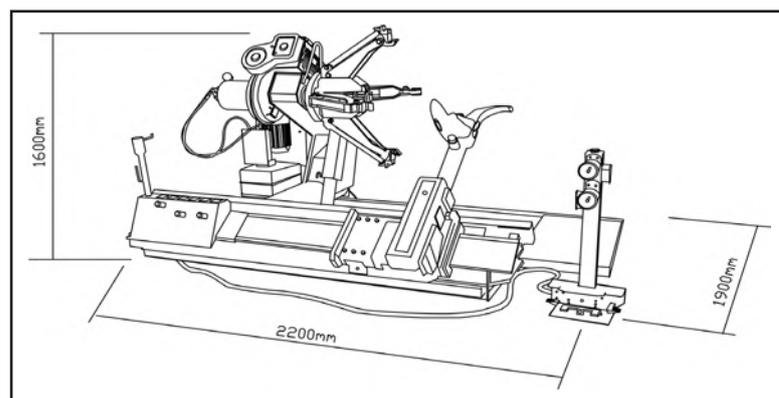
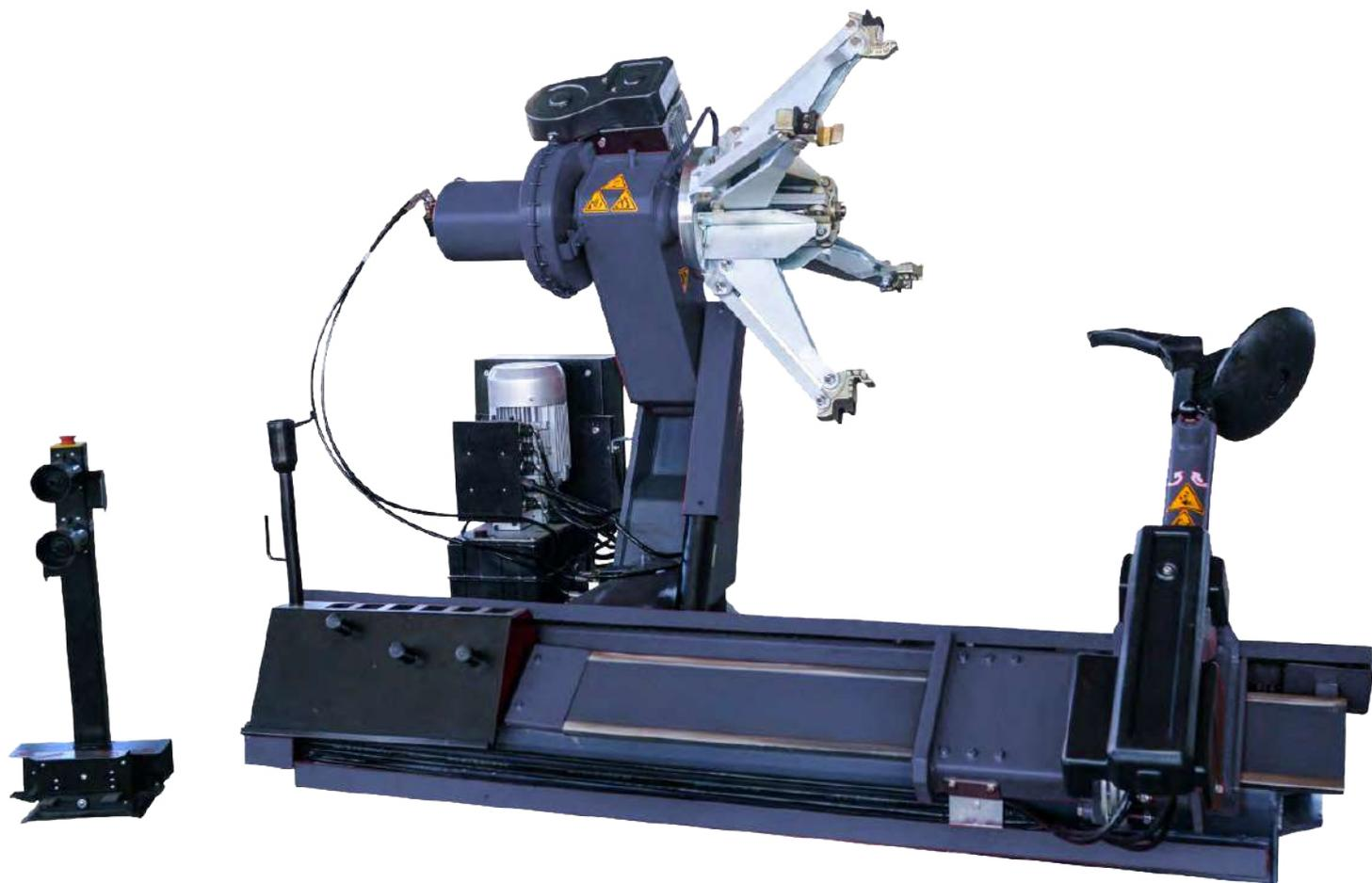

Características:
 Diâmetro da jante: 14"~56"
 Diâmetro máximo pneu: Φ 2500mm
 Peso máximo pneu: 2,000kg
 Potência eixo principal do motor: 3.3kW/220V/50/60Hz/3Ph
 Potência motor da estação hidráulica: 4.0kW/220V/50/60Hz/3Ph
 Pressão trabalho do sistema hidráulico: 15MPa~18MPa
 Pressão máxima de funcionamento do sistema Hidráulico: 20MPa
 Ruído: \leq 70dB

Características:
 Diámetro llanta: 14"~56"
 Diámetro máximo del neumático: Φ 2500mm
 Peso máximo del neumático: 2.000kg
 Potencia del motor del eje principal: 3.3kW/220V/50/60Hz/3Ph
 Potencia del motor de la estación hidráulica: 4.0kW/220V/50/60Hz/3Ph
 Presión nominal de trabajo del sistema hidráulico: 15MPa~18MPa
 Presión máxima de trabajo del sistema hidráulico: 20MPa
 Ruido: \leq 70dB

REF
9008

1145kg

1x

 Suporte colaça 2 peças
 Soportes culata 2 piezas



 **Descrição:**
 Um par de suportes de apoio que se localizam na cabeça do cilindro através de orifícios de encaixe
 Também proporciona a folga entre a cabeça e a bancada de trabalho necessária para a escareação das guias das válvulas

 **Descripción:**
 Un par de soportes que se ubican en la culata a través de agujeros con llave
 También proporciona el espacio libre entre la cabeza y el banco de trabajo necesario para escariar las guías de las válvulas

REF

4829



1,62kg



8x

 Suporte motos 300kg
 Soporte motos 300kg



 **Características:**
 Capacidade: 300kg
 Altura: 400mm
 Largura: 360mm
NOTA: Indicado para roda frontal

 **Características:**
 Capacidad: 300kg
 Altura: 400mm
 Anchura: 360mm
NOTA: Adecuado para la rueda delantera

REF

4831



5kg



1x

 Jogo garras de moto para máquina calibrar rodas - modelo 9022
 Juego garras moto para equilibradora ruedas - modelo 9022



 **Características:**
 Buraco de montagem: 16mm
 Diâmetro do eixo: 36mm
NOTA: Compatível com Máquina calibrar rodas semi-automática 10"-24", Ref: 9022

 **Características:**
 Agujero de montaje: 16mm
 Diámetro del eje: 36mm
NOTA: Compatible con Equilibradora ruedas semi-automatica 10"-24", Ref: 9022

REF

9028



3,5kg



1x

 Suporte motor universal
 Soporte motor universal



 **Características:**
 Altura H: 300mm
 Comprimento total: 1000mm
 Largura total: 510mm
 Capacidade: 400kg
 Distância máxima suporte pé: 450mm
Descrição: Manuseamento simples e rápido

 **Características:**
 Altura H: 300mm
 Longitud total: 1000mm
 Anchura total: 510mm
 Capacidad: 400kg
 Distancia máxima de la pata de apoyo de la viga: 450mm
Descripción: Manejo sencillo y rápido

REF

4833



10kg



1x

-  Barra reforçada motor
-  Travesía reforzada soporte



-  **Características:**
- Largura mínima: 725mm
- Largura máxima: 1480mm
- Capacidade: 500kg
- Comprimento da corrente: 1M
- Altura ajustável: 0-205mm

-  **Características:**
- Ancho mínimo: 725mm
- Ancho máximo: 1480mm
- Capacidad: 500kg
- Longitud de la cadena: 1M
- Altura ajustable: 0-205mm

REF



2062

16,5kg

1x

-  Suporte de motor rotativo
-  Soporte de motor rotativo



-  **Características:**
- Capacidade de suporte: 450kg
- Base de suporte: 250x150mm
- Área mínima de agarre: 292x122mm
- Área máxima de agarre: 402x152mm
- 8 posições
- Rotação de 360°

-  **Características:**
- Capacidad de soporte: 450kg
- Base de soporte: 250x150mm
- Área mínima de agarre: 292x122mm
- Área máxima de agarre: 402x152mm
- 8 posiciones
- Rotación de 360°

REF



4830

20kg

1x

-  Suporte motor rotativo
-  Soporte motor rotativo



-  **Características:**
- Capacidade: 550kg
- Altura mínima: 150mm
- Altura máxima: 2300mm
- Construção robusta em aço
- Mecanismo de bloqueio ajustável
- Rotação 360° motor
- Pernas dobráveis
- Pernos de montagem ajustáveis

-  **Características:**
- Capacidad: 550kg
- Altura mínima: 150mm
- Altura máxima: 2300mm
- Construcción robusta de acero
- Mecanismo de bloqueo ajustable
- Rotación 360° motor
- Patas plegables
- Patatas de montaje ajustables

REF



4855

48kg

1x

 Máquina ATF automática com kit adaptadores

 Máquina para cambio de aceite de transmisión automática ATF con adaptadores



 **Descrição:** Esta máquina automática de troca e lavagem de óleo de transmissão remove, limpa e substitui óleos e fluidos da maioria dos tipos e versões de transmissão automática, caixas de velocidades, engrenagens de torque hidráulico, refrigeradores de caixas de velocidades e linhas de refrigeradores de caixas de velocidades

Características:

Fonte de energia: 12 V (bateria do carro)
 Potência da bomba: 70W
 Diâmetro do manómetro do óleo: 70mm (ambos manómetros)
 Gama de manómetros de pressão de óleo: 0-10 bar (0-150 psi) (ambos os manómetros de pressão de óleo)
 Capacidade do tanque de óleo novo: 30L
 Capacidade do tanque de óleo usado: 30L
 Mangueira para óleo: comprimento 126 x Ø 12,5mm (1/2) (vermelha)
 Mangueira para óleo: comprimento 126 x Ø 12,5mm (1/2) (preta)
 Pressão máxima da mangueira: 300 psi (20 bar)

 **Descripción:** Esta máquina de lavado y cambio de aceite de transmisión automática elimina, limpia y sustituye los aceites y fluidos de la mayoría de los tipos y versiones de transmisión automática, cajas de cambio engranajes de par hidráulico, refrigeradores de caja de cambios y los conductos del refrigerador de la caja de cambios

Características:

Fuente de alimentación: 12 V (batería de coche)
 Potencia de la bomba: 70W
 Diámetro del manómetro de aceite: 70mm (ambos manómetros)
 Rango del manómetro de aceite: 0-10 bar (0-150 psi) (ambos manómetros de aceite)
 Capacidad del depósito de aceite nuevo: 30L
 Capacidad del depósito de aceite usado: 30L
 Manguera de aceite: longitud 126 x Ø 12,5mm (1/2 pulgada) (rojo)
 Manguera de aceite: longitud 126 x Ø 12,5mm (1/2 pulgada) (negra)
 Presión máxima de la manguera: 300 psi (20 bar)

REF
9020

24kg

1x

- Máquina limpeza e troca óleo ATF - automática
- Maquina para cambio de aceite de transmission automatica ATF con adaptadores



Descrição: Deteta automaticamente as direções de entrada e saída do óleo, simplificando o processo. Substitui até 99% do óleo, garantindo uma troca completa. Otimiza o desempenho e aumenta a durabilidade da caixa de velocidades. Ideal para manter e prolongar a vida útil das transmissões automáticas

Características:

- Tensão de Funcionamento: DC 12V
- Potência Máxima: 150W
- Manómetro de Pressão: 0 - 1,6 MPa
- Precisão do Filtro: 20 µm
- Comprimento do Tubo de Entrada de Fluido: 3m
- Comprimento do Tubo de Retorno de Fluido: 3m
- Comprimento do Tubo de Drenagem de Óleo: 1,5m
- Depósitos de Óleo: 2 unidades, 20L cada
- Erro de Substituição Equivalente: 0,01L
- Nível de Ruído: <70 dB
- Dimensões da Máquina: 555x475x1060mm
- Humidade Relativa: Até 85%
- Temperatura de Funcionamento: -5°C a +40°C

Descripción: Detecta automáticamente las direcciones de entrada y salida del aceite, simplificando el proceso. Sustituye hasta el 99% del aceite, garantizando un cambio completo. Optimiza el rendimiento y aumenta la durabilidad de la caja de cambios. Ideal para mantener y prolongar la vida útil de las transmisiones automáticas

Características:

- Voltaje de Trabajo: DC 12V
- Potencia Máxima: 150W
- Manómetro de Presión: 0 - 1,6 MPa
- Precisión del Filtro: 20 µm
- Longitud del Tubo de Entrada de Fluidos: 3m
- Longitud del Tubo de Retorno de Fluidos: 3m
- Longitud del Tubo de Drenaje de Aceite: 1,5m
- Cubos de Aceite: 2 unidades, 20L cada uno
- Error de Reemplazo Equivalente: 0,01L
- Nivel de Ruido: <70 dB
- Dimensiones de la Máquina: 555x475x1060mm
- Humedad Relativa: Hasta 85%
- Rango de Temperatura de Funcionamiento: -5°C a +40°C

REF
9120

50kg

1x

 **Jogo completo adaptadores especiais ATF**
 **Juego completo de adaptadores especiales para máquina ATF**



Adaptadores Mercedes 7AT/6AT 4pcs
Adaptador Mercedes 7at/6at 4pzs



REF 9121-01

Adaptadores Audi CVT 2pcs
Adaptador Audi CVT 2pzs



REF 9121-02

Adaptador BMW 6AT
adaptador BMW 6AT



REF 9121-03

Adaptador Opel/ Chevrolet 6AT
Adaptador Opel/ Chevrolet 6AT



REF 9121-04

Adaptador Mercedes 9AT
Adaptador Mercedes 9AT



REF 9121-05

Adaptador Fiat 4/5/6AT - CVT - 7DCT
Adaptador Fiat 4/5/6AT - CVT - 7DCT



REF 9121-06

Adaptadores BMW 6/8HP 11pcs
Adaptador BMW 6/8HP 11pzs



REF 9121-07

Adaptadores Porsche 7DCT 6pcs
Adaptador Porsche 7DCT 6pzs



REF 9121-08

Adaptadores Dodge CVT 2pcs
Adaptador Dodge CVT 2pzs



REF 9121-09

Adaptadores BMW 09G 2pcs
Adaptador BMW 09G 2pzs



REF 9121-10

Adaptadores Peugeot 4AT 2pcs
Adaptador Peugeot 4AT 2pzs



REF 9121-11

Adaptadores Alfa Romeo 6AT 2pcs
Adaptador Alfa Romeo 6AT 2pzs



REF 9121-12

Adaptadores Ford 6AT 3pcs
Adaptador Ford 6AT 3pzs



REF 9121-13

Adaptadores Land Rover 6/8HP 10pcs
Adaptador Land Rover 6/8HP 10pzs



REF 9121-14

Adaptadores Mercedes 5AT 2pcs
Adaptador Mercedes 5AT 2pzs



REF 9121-15

Adaptadores Volvo 5 speed 6pcs
Adaptador volvo 5 speed 6pzs



REF 9121-16

Adaptadores Audi 8AT 5pcs
Adaptador Audi 8AT 5pzs



REF 9121-17

Adaptadores Jeep 9AT 3pcs
Adaptador Jeep 9AT 3pzs



REF 9121-18

Adaptadores VW 6/7 DCT 7pcs
Adaptador VW 6/7 DCT 7pzs



REF 9121-19

Adaptador Audi/VW OCK/DCT/7 WET DCT
Adaptador Audi/VW OCK/DCT/7 WET DCT



REF 9121-20

Adaptador Mercedes 7 DCT
Adaptador Mercedes 7 DCT



REF 9121-21

Adaptador Audi/VW/ Porsche
Adaptador Audi/VW/ Porsche 01J/01T/5HP/ DCT/09L



REF 9121-22

Adaptador Mercedes 7 DCT/DCT
Adaptador Mercedes 7 DCT/DCT



REF 9121-23

 **Descrição:**

Design de engate rápido para fácil instalação
 Conexões com rosca para maior segurança
 Adaptadores tipo pagoda com mangueiras incluídas
 Placas de pressão para estabilidade e eficiência

Características:

Adaptadores ATF
 Material: Alumínio + Ferro
 (98x) Adaptadores Metálicos (placas de pressão, engates rápidos e roscas)
 (8x) Mangueiras
 (2x) Adaptador Rápidos Tipo Pagoda
 (14x) Anéis de Vedação

 **Descripción:**

Diseño de acople rápido para una instalación sencilla
 Conexiones con rosca para mayor seguridad
 Adaptadores tipo pagoda con mangueiras incluídas
 Placas de presión para estabilidad y eficiencia

Características:

Adaptador ATF
 Material: Alumínio + Hierro
 (98x) Adaptadores metálicos (placas de presión, acoples rápidos y roscas)
 (8x) Mangueiras
 (2x) Adaptadores rápidos tipo pagoda
 (14x) Anillos de sellado

REF

9121



12kg



1x

 Máquina limpeza circuito refrigeração
 Máquina de cambio del circuito de refrigeración



Características:
Ecrã tátil LCD de 7 polegadas a cores
Controlo eletrónico inteligente da mudança automática equivalente de fluido novo/usado
Fonte de alimentação: DC12V-150w
Manómetro: 0~2kg/cm²
Mangueria de saída do fluido: 2.3m
Mangueria de retorno do fluido: 2.3m
Depósito de fluido novo/usado: 20Lx2
Dimensões: 630x670x1120mm

Funcionamento: Função com Limpeza do ciclo; Enchimento; Recuperação do fluido usado; Extração do líquido de refrigeração; Alerta de falta de fluido

Características:
Pantalla táctil LCD de 7 pulgadas en color
Control electrónico inteligente del cambio automático equivalente de fluido nuevo/usado
Alimentación: DC12V-150w
Manómetro: 0~2kg/cm²
Manguera de salida de fluido: 2.3m
Manguera de retorno de fluido: 2.3m
Depósito de fluido nuevo/usado: 20Lx2
Dimensiones: 630x670x1120mm

Operación: Función con Limpieza cíclica; Llenado; Recuperación de fluido usado; Extracción de refrigerante; Alerta de falta de fluido

REF
9019

48kg

1x

-  Máquina ar condicionado R134a
 Maquina para carga de aire acondicionado R134a

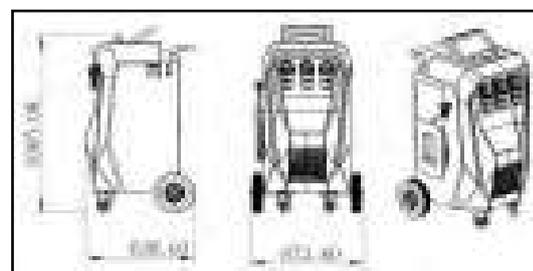

Características:
 Refrigerante: R134a
 Fonte de alimentação: 220V
 Consumo de energia: 1200W
 Intervalo de temperatura operacional da unidade: -20°C ~ +60°C
 Ecrã: Ecrã táctil de 10 polegadas
 Garrafa de óleo: 350ml (3 Garrafas de óleo seladas, PAG/POE/óleo usado)
 Balanças eletrónicas: 4 (Reservatório de refrigerante, PAG/POE/óleo usado)
 Precisão da balança: 10g
 Eficiência de recuperação: acima de 95%
 Capacidade de recuperação: 3/8HP
 Capacidade de vácuo: 170L/min (6 CFM)
 Capacidade do tanque de refrigerante: 12Kg
 Capacidade do filtro: 100Kg
 Manómetros de pressão: Ecrã numérico de pressão digital
 Sistema de ventilação: 2 ventiladores eletrónicos redundantes
Dimensões: 673.80mm (Comprimento)x638.93mm(Largura)x1065.08mm (Altura)

Características:
 Refrigerante: R134a
 Fuente de alimentación: 220V
 Consumo de energía: 1200W
 Rango de temperatura de funcionamiento de la unidad: -20°C ~ +60°C
 Pantalla: Pantalla táctil de 10 pulgadas
 Botella de aceite: 350ml (4 Botella de aceite sellada, PAG/POE/Aceite usado)
 Básculas electrónicas: 4 (Tanque refrigerante, PAG/POE/Aceite usado)
 Precisión de la báscula: 10g
 Eficacia de la recuperación: Más de 95%
 Capacidad de recuperación: 3/8HP
 Capacidad de vacío: 170L/min (6 CFM)
 Capacidad del tanque de refrigerante: 12Kg
 Capacidad del filtro: 100Kg
 Manómetros: Pantalla numérica de presión digital
 Sistema de ventilador: 2 Ventiladores redundantes electrónicas
Dimensiones: 673.80mm (Longitud)x638.93mm (Anchura)x1065.08mm (Altura)

REF
9040

94kg

1x

- Máquina ar condicionado R1234yf
- Maquina para carga de aire acondicionado R1234yf



Características:
 Refrigerante: R1234yf
 Fonte de alimentação: 220V
 Consumo de energia: 1200W
 Intervalo de temperatura operacional da unidade: -20°C ~ +60°C
 Ecrã: Ecrã táctil de 10 polegadas
 Garrafa de óleo: 350ml (4 Garrafas de óleo seladas, PAG/POE/UV/ óleo usado)
 Balanças eletrónicas: 5 (Reservatório de refrigerante, PAG/POE/UV/óleo usado)
 Precisão da balança: 10g
 Eficiência de recuperação: acima de 95%
 Capacidade de recuperação: 3/8HP
 Capacidade de vácuo: 170L/min (6 CFM)
 Capacidade do tanque de refrigerante: 15Kg
 Capacidade do filtro: 100Kg
 Manómetros de pressão: Ecrã numérico de pressão digital
 Sistema de ventilação: 3 ventiladores eletrónicos redundantes
Dimensões:
 726.40mm (Comprimento)x660mm (Largura)x1163.81mm (Altura)

Características:
 Refrigerante: R1234yf
 Fuente de alimentación: 220V
 Consumo de energía: 1200W
 Rango de temperatura de funcionamiento de la unidad: -20°C ~ +60°C
 Pantalla: Pantalla táctil de 10 pulgadas
 Botella de aceite: 350ml (4 Botella de aceite sellada, PAG/POE/UV/ Aceite usado)
 Básculas electrónicas: 5 (Tanque refrigerante, PAG/POE/UV/Aceite usado)
 Precisión de las báscula: 10g
 Eficiencia de recuperación: Más de 95%
 Capacidad de recuperación: 3/8HP
 Capacidad de vacío: 170L/min (6CFM)
 Capacidad del tanque de refrigerante: 15Kg
 Capacidad del filtro: 100Kg
 Manómetros: Pantalla numérica de presión digital
 Sistema de ventilador: 3 Ventiladores redundantes electrónicas
Dimensiones:
 726.40mm (Longitud)x660mm (Anchura)x1163.81mm (Altura)

REF
9041

110kg

1x

-  Elevador de motos hidráulico 450kg
 Elevador de motos hidráulico 450kg

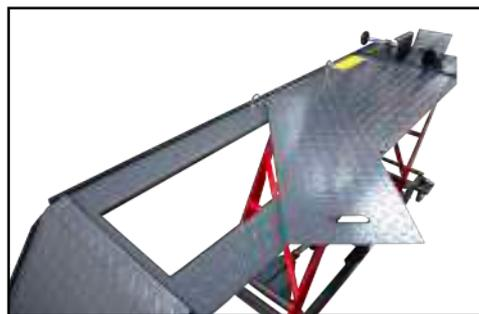

- ① **Nota:** Em caso de atualização do modelo do elevador, consultar as medidas no site KROFtools
- ① **Nota:** En caso de actualización del modelo del elevador, consultar las medidas en el sitio web de KROFtools

 **Características:**
 Capacidade: 450kg
 Altura mínima: 175mm
 Altura máxima: 750mm
 Medidas plataforma: 2060x550mm
 Medidas rampa: 650x550mm

 **Características:**
 Capacidad: 450kg
 Altura mínima: 175mm
 Altura máxima: 750mm
 Medidas plataforma: 2060x550mm
 Medidas rampa: 650x550mm

REF
9860

112kg

1x

 Elevador de motos hidropneumático 680kg

 Elevador de motos hidroneumático 680kg



- ① **Nota:** Em caso de atualização do modelo do elevador, consultar as medidas no site KROFtools
- ① **Nota:** En caso de actualización del modelo del elevador, consultar las medidas en el sitio web de KROFtools

 **Características:**
Capacidade: 680kg
Altura mínima: 185mm
Altura máxima: 825mm
Medidas plataforma: 2000x1218mm (com calhas laterais)
Medidas rampa: 550x1218mm (com calhas laterais)
Pressão de ar: 110-120psi

 **Características:**
Capacidad: 680kg
Altura mínima: 185mm
Altura máxima: 825mm
Medidas plataforma: 2000x1218mm (con placas laterales)
Medidas rampa: 550x1218mm (con placas laterales)
Presión de aire: 110-120psi

REF

9865



238kg



1x

-  Elevador de motos hidráulico 135kg
 Elevador de motos hidráulico 135kg

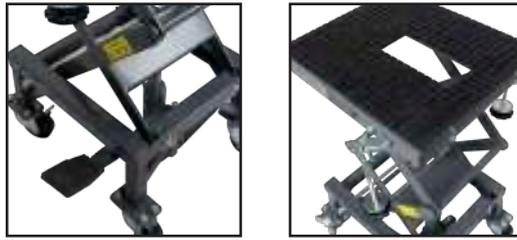

- ① **Nota:** Em caso de atualização do modelo do elevador, consultar as medidas no site KROFtools
 ① **Nota:** En caso de actualización del modelo del elevador, consultar las medidas en el sitio web de KROFtools

 **Características:**
 Capacidade: 135kg
 Altura mínima: 350mm
 Altura máxima: 870mm
 Tamanho plataforma: 410x350mm

 **Características:**
 Capacidad: 135kg
 Altura mínima: 350mm
 Altura máxima: 870mm
 Tamaño de la plataforma: 410x350mm

REF

9866



29kg



1x

-  Elevador roda elétrica 65kg
-  Elevador rueda eléctrica 65kg



- ① **Nota:** Em caso de atualização do modelo do elevador, consultar as medidas no site KROFtools
- ① **Nota:** En caso de actualización del modelo del elevador, consultar las medidas en el sitio web de KROFtools

Características:
 Máx. peso de elevação: 65Kg
 Altura de elevação: 0~1.2m
 Tempo de elevação: 12~16s
 Potência motor: 200W
 Tensão do motor: 24V
 Ciclos de trabalho com bateria carregada: 150~200 ciclos
 Tensão de carregamento: AC 110V-220V 50Hz/60Hz

Características:
 Max. peso de elevación: 65Kg
 Altura de elevación: 0~1.2m
 Tiempo de elevación: 12~16s
 Potencia del motor: 200W
 Voltaje del motor: 24V
 Ciclos de trabajo con la batería cargada: 150~200 ciclos
 Voltaje de carga: AC 110V-220V 50Hz/60Hz

REF
9023

70kg



1x



Elevador roda 100kg

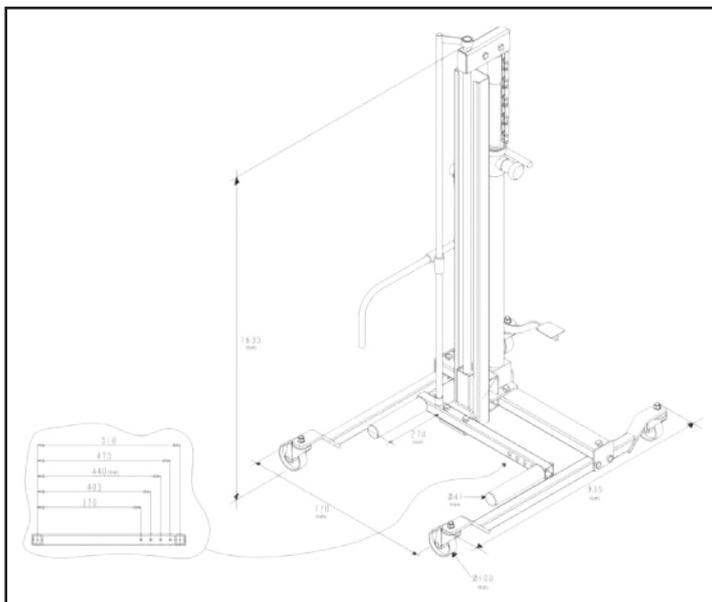
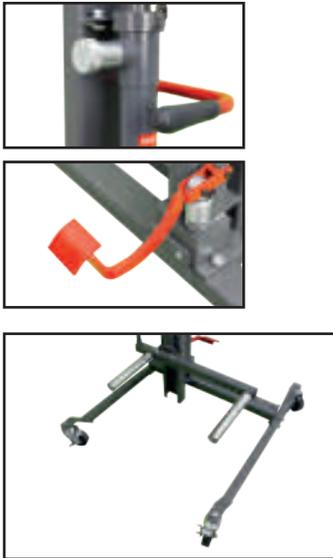

Elevador rueda 100kg



⚠ **Nota:** Em caso de atualização do modelo do elevador, consultar as medidas no site KROFtools

⚠ **Nota:** En caso de actualización del modelo del elevador, consultar las medidas en el sitio web de KROFtools

**Características:**

Medidas gerais elevador: 770x935x1635mm
 Diâmetro rodas elevador: 100mm
 Comprimento colocação rodas (ajustável): 370, 405, 440, 475, 510mm
 Largura colocação rodas: 270mm
 Capacidade para rodas: Até 100Kg

**Características:**

Medidas generales elevador: 770x935x1635mm
 Diámetro ruedas elevador: 100mm
 Longitud colocación ruedas (ajustable): 370, 405, 440, 475, 510mm
 Ancho colocación ruedas: 270mm
 Capacidad para ruedas: Hasta 100Kg

REF

9026



74kg



1x

-  Porta pneus 250kg
-  Porta neumáticos 250kg



Características:
 Capacidade: até 250kg
 Comprimento pega: 1000mm
 Largura estrutura: 700mm
 Tamanho da roda adequado: 250-800mm

Características:
 Capacidad: hasta 250kg
 Longitud del mango: 1000mm
 Ancho estructura: 700mm
 Tamaño de rueda adecuado: 250-800mm

REF		
9027	15kg	1x

-  Elevador roda pneumático para desmontadora pneus 70kg
-  Elevador rueda neumático para desmontadora 70kg



Características:
 Peso máximo de elevação: 70kg
 Altura mínima: 76mm
 Altura máxima de elevação: 770mm
 Comprimento total: 810mm
 Largura total: 725mm
 Abastecimento de ar: 8~10 bar

Características:
 Peso máximo de elevación: 70kg
 Altura mínima: 76mm
 Altura máxima elevación: 770mm
 Longitud total: 810mm
 Anchura total: 725mm
 Suministro de aire: 8~10 bar

- ⓘ **Nota:** Em caso de atualização do modelo do elevador, consultar as medidas no site KROFtools
- ⓘ **Nota:** En caso de actualización del modelo del elevador, consultar las medidas en el sitio web de KROFtools

REF		
9024	48kg	1x

-  Elevador roda pneumático para balanceadora pneus 80kg
 Elevador rueda neumático para equilibradora 80kg

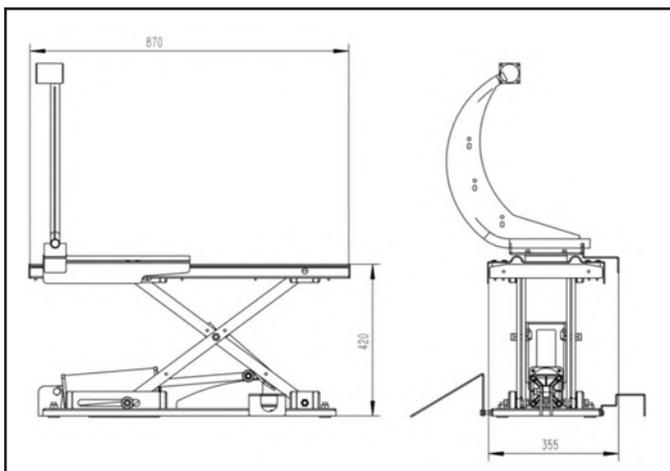

- ⓘ **Nota:** Em caso de atualização do modelo do elevador, consultar as medidas no site KROFtools
 ⓘ **Nota:** En caso de actualización del modelo del elevador, consultar las medidas en el sitio web de KROFtools

 **Características:**
 Peso máximo de elevação: 80kg
 Altura mínima: 130mm
 Altura máxima de elevação: 420mm
 Comprimento total: 870mm
 Largura total: 355mm
 Abastecimento de ar: 8~10 bar

 **Características:**
 Peso max. de elevación: 80kg
 Altura mínima: 130mm
 Altura máxima elevación: 420mm
 Longitud total: 870mm
 Anchura total: 355mm
 Suministro de aire: 8~10 bar

REF
9025

 32kg

 1x

-  Elevador de roda pneumático
-  Elevador de rueda neumático



Pedal elevador de roda pneumático
Pedal elevador de rueda neumático



REF 9850P

⚠ **Nota:** Em caso de atualização do modelo do elevador, consultar as medidas no site KROFtools

⚠ **Nota:** En caso de actualización del modelo del elevador, consultar las medidas en el sitio web de KROFtools

 **Características:**
Carga máxima permitida: 1360Kg
Dimensões gerais: 1000x710x1310mm
Altura máxima: 750mm
Altura mínima: 50mm
Pressão bomba: 350 bar

 **Características:**
Carga máxima permitida: 1360Kg
Dimensiones generales: 1000x710x1310mm
Altura máxima: 750mm
Altura mínima: 50mm
Presión de la bomba: 350 bar

REF
9850

99kg

1x



Elevador de roda pneumático



Elevador de rueda neumático



ⓘ **Nota:** Em caso de atualização do modelo do elevador, consultar as medidas no site KROFtools

ⓘ **Nota:** En caso de actualización del modelo del elevador, consultar las medidas en el sitio web de KROFtools

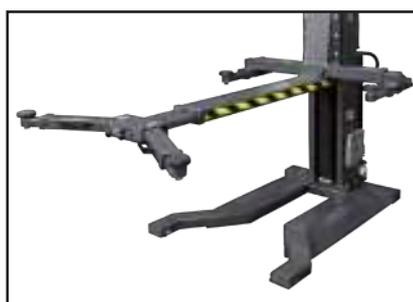
**Características:**

Capacidade de elevação: 2.7T
 Altura máxima de elevação: 1920mm
 Largura máxima do veiculo a ser levantado: <1800mm
 Ruído: 70db
 Potência: 2.2KW
 Voltagem: 220V / 380V
 Velocidade subida: 50mm/s
 Temperatura trabalho: -5 °C/+40°C
 Ambiente: Interior
 Bloqueio de segurança: Manual

**Características:**

Capacidad elevación: 2.7T
 Altura máxima de elevación: 1920mm
 Anchura máxima del vehículo a levantar: <1800mm
 Ruido: 70db
 Potencia: 2.2KW
 Voltaje: 220V / 380V
 Velocidad subida: 50mm/s
 Temperatura ambiente trabajo: -5 °C/+40°C
 Ambiente: Interior
 Bloqueo seguridad: Manual

REF

220V
380V860kg
860kg1x
1x

Coluna para elevador multi-coluna wireless 8T
Columna para elevador multi-columna wireless 8T

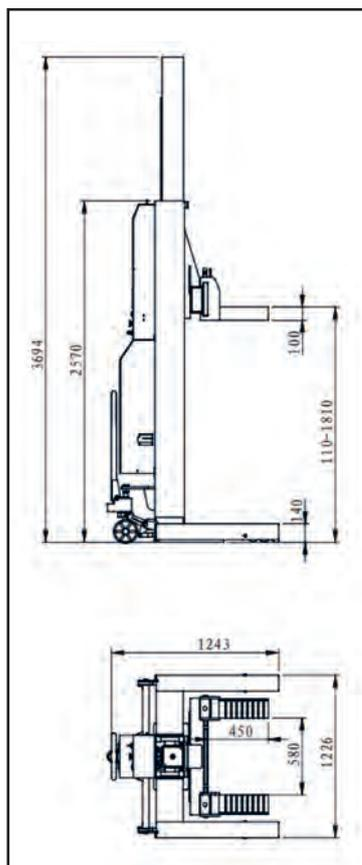

ⓘ **Nota:** Em caso de atualização do modelo do elevador, consultar as medidas no site KROFtools

ⓘ **Nota:** En caso de actualización del modelo del elevador, consultar las medidas en el sitio web de KROFtools

Características:

Funcionamento: Eléctrico hidráulico
Peso máximo de elevação: 8000kg
Altura de elevação: 1810mm
Altura inicial: 110mm
Tempo de elevação: ≤80s
Tempo de descida: ≤100s
Largura total: 1226mm
Potência da máquina: 3,0 KW
Óleo hidráulico: 14L 46#
Temperatura de trabalho: 5-40°C
Humidade de trabalho: 30-95%
Nível de ruído: <76db
Temperatura de armazenamento: -25° ~ 55°C
Local de instalação: Interior

Características:

Accionamiento: Eléctrico hidráulico
Peso máximo de elevación: 8000kg
Altura de elevación: 1810mm
Altura inicial: 110mm
Tiempo de elevación: ≤80s
Tiempo de descenso: ≤100s
Anchura total: 1226mm
Potencia de la máquina: 3,0 KW
Aceite hidráulico: 14L 46#
Temperatura de trabajo: 5-40°C
Humedad de trabajo: 30-95%
Nivel de ruido: <76db
Temperatura de almacenamiento: -25°~55°
Lugar de instalación: Interior

REF

9885



669kg



1x

 Elevador parqueamento 2.7T
 Elevador de parking 2.7T



- ⓘ **Nota:** Em caso de atualização do modelo do elevador, consultar as medidas no site KROFtools
 ⓘ **Nota:** En caso de actualización del modelo del elevador, consultar las medidas en el sitio web de KROFtools

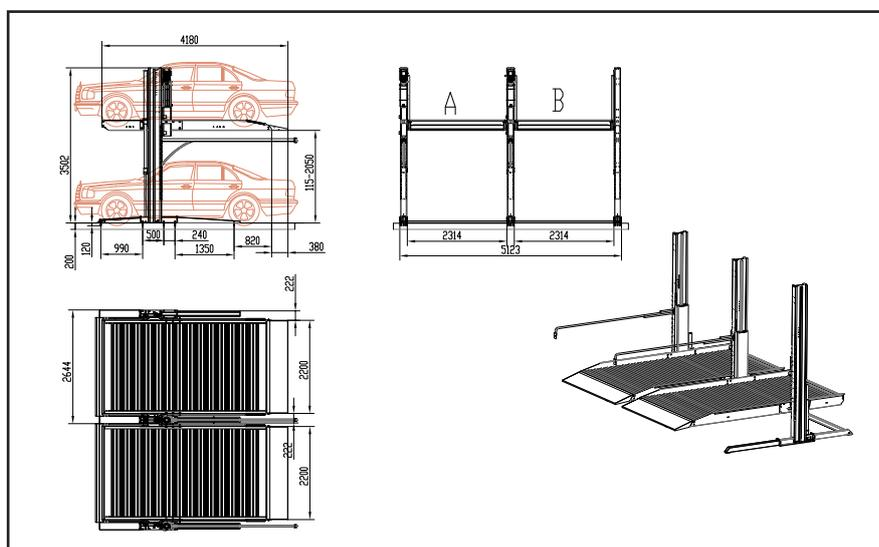

 **Características:**

Capacidade de elevação: 2.7T
 Altura de elevação: 2160mm
 Tempo de elevação: 65s
 Altura total: ≤3502mm
 Largura total: 2644mm
 Largura da plataforma: 2200mm
 Comprimento da plataforma: ≤4180mm
 Motor: 2.2kw, 230V/60Hz, 3Ph
 Tempo de subida com motor trifásico: ≤75sec
 Tempo de subida com motor monofásico: ≤75sec
 Tempo de descida: 18sec≤t≤60sec
 Nível de ruído: ≤70dB (A)
 Temperatura de funcionamento: 0°C-50°C
 Humidade relativa: 90%

 **Características:**

Capacidad de elevación: 2.7T
 Altura de elevación: 2160mm
 Tiempo de elevación: 65s
 Altura total: ≤3502mm
 Anchura total: 2644mm
 Anchura de la plataforma: 2200mm
 Longitud de la plataforma: ≤4180mm
 Motor: 2.2kw, 230V/60Hz, 3Ph
 Tiempo de subida con motor trifásico: ≤75sec
 Tiempo de subida con motor monofásico: ≤75sec
 Tiempo de descenso: 18sec≤t≤60sec
 Nivel de ruido: ≤70dB (A)
 Temperatura de funcionamiento: 0°C-50°C
 Humidad relativa: 90%

REF

9881



1034kg



1x

 Elevador parqueamento - Adicional 9881

 Elevador de parking - Adicional 9881



① **Nota:** Em caso de atualização do modelo do elevador, consultar as medidas no site KROftools

① **Nota:** En caso de actualización del modelo del elevador, consultar las medidas en el sitio web de KROftools

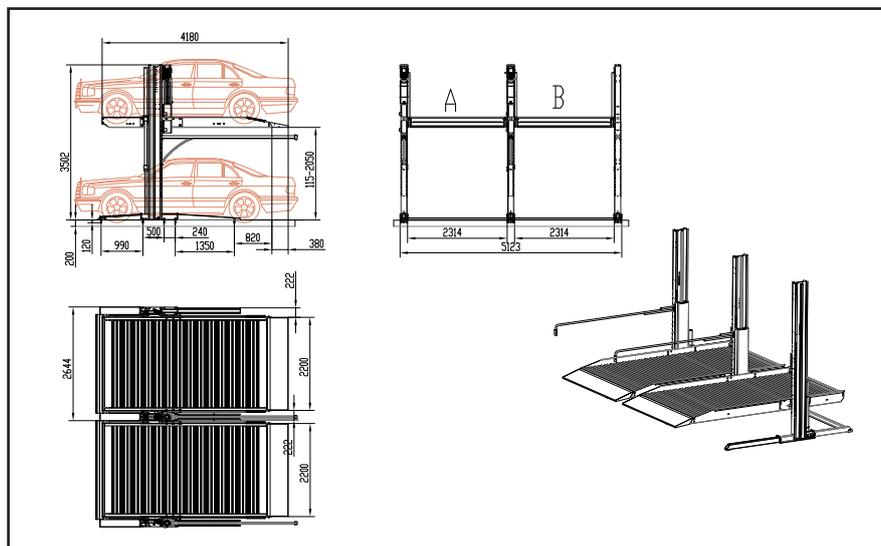

 **Características:**

Capacidade de elevação: 2.7T
 Altura de elevação: 2160mm
 Tempo de elevação: 65s
 Altura total: ≤3502mm
 Largura total: 2644mm
 Largura da plataforma: 2200mm
 Comprimento da plataforma: ≤4180mm
 Motor: 2.2kw, 230V/60Hz, 3Ph
 Tempo de subida com motor trifásico: ≤75sec
 Tempo de subida com motor monofásico: ≤75sec
 Tempo de descida: 18sec≤t≤60sec
 Nível de ruído: ≤70dB (A)
 Temperatura de funcionamento: 0°C-50°C
 Humidade relativa: 90%

 **Características:**

Capacidad de elevación: 2.7T
 Altura de elevación: 2160mm
 Tiempo de elevación: 65s
 Altura total: ≤3502mm
 Anchura total: 2644mm
 Anchura de la plataforma: 2200mm
 Longitud de la plataforma: ≤4180mm
 Motor: 2.2kw, 230V/60Hz, 3Ph
 Tiempo de subida con motor trifásico: ≤75sec
 Tiempo de subida con motor monofásico: ≤75sec
 Tiempo de descenso: 18sec≤t≤60sec
 Nivel de ruido: ≤70dB (A)
 Temperatura de funcionamiento: 0°C-50°C
 Humidad relativa: 90%

REF

9882



629kg



1x

 Elevador de 2 colunas eletro hidráulico 4T

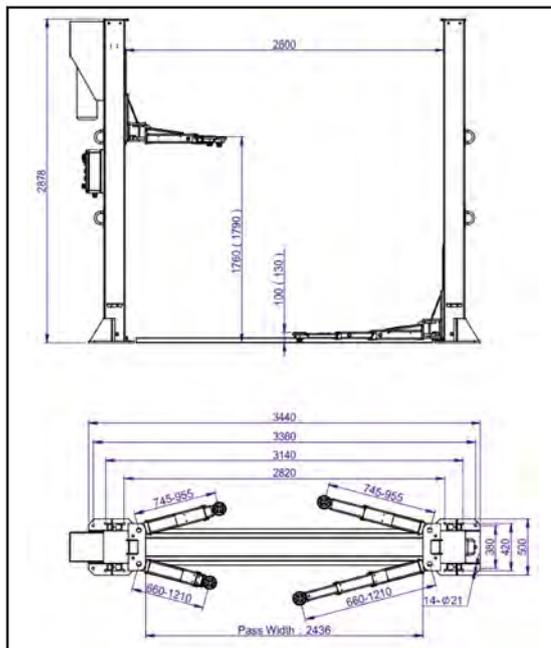
 Elevador de 2 columnas electro hidráulico 4T

 Bases reforço
 Bases reforzadas

REF 9805BR

 Borracha redonda 120mm 1 furo
 Goma redonda 120mm 1 agujero

REF 9805B2

 Borracha redonda 120mm 2 furos
 Goma redonda 120mm 2 agujeros

REF 9805B2F

⚠ **Nota:** Em caso de atualização do modelo do elevador, consultar as medidas no site KROFtools

⚠ **Nota:** En caso de actualización del modelo del elevador, consultar las medidas en el sitio web de KROFtools

**Características:**

9805: Potência: 380V 50HZ
 9805MO: Potência: 220V 50HZ
 Largura entre colunas: 2800mm
 Altura total: 2878mm
 Elevação: 100/130mm a 1760/1790mm
 Altura inicial: 100/130mm
 Tempo de elevação: ≤50s
 Tempo de descida: ≤60s
 Nível de ruído: < 76db
 Óleo hidráulico: 7L 20#
 Potência: 2.2KW

**Características:**

9805: Potencia: 380V 50HZ
 9805MO: Potencia: 220V 50HZ
 Ancho entre columnas: 2800mm
 Altura total: 2878mm
 Elevación: 100/130mm a 1760/1790mm
 Altura original: 100/130mm
 Tiempo de elevación: ≤50s
 Tiempo de descenso: ≤60s
 Nivel de ruido: < 76db
 Aceite hidráulico: 7L 20#
 Potencia: 2.2KW

REF



 9805
 9805MO

 380V
 220V

 671kg
 671kg

 1x
 1x

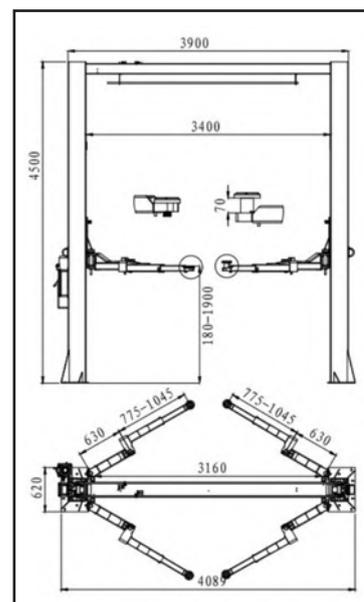
-  Elevador 2 colunas 5T 380V
-  Elevador 2 columnas 5T 380V



- ⚠ **Nota:** Em caso de atualização do modelo do elevador, consultar as medidas no site KROFtools
- ⚠ **Nota:** En caso de actualización del modelo del elevador, consultar las medidas en el sitio web de KROFtools

Características:
 Sistema de controlo: Eléctrico hidráulico
 Capacidade elevação: 5T
 Altura de elevação: 1900mm
 Altura inicial: 180mm
 Tempo de elevação: 80s
 Tempo de descida: 100s
 Largura de passe: 3160mm
 Largura total: 4089mm
 Voltagem: 380V
 Potência da máquina: 2.2KW
 Óleo hidráulico: 10L 20#
 Temperatura de trabalho: 5~40°C
 Humidade de trabalho: 30-95%
 Ruído: <76db

Características:
 Sistema de control: Eléctrico hidráulico
 Peso máximo de elevación: 5T
 Altura de elevación: 1900mm
 Altura inicial: 180mm
 Tiempo de elevación: 80s
 Tiempo de descenso: 100s
 Ancho de paso: 3160mm
 Ancho total: 4089mm
 Tensión: 380V
 Potencia de la máquina: 2.2KW
 Aceite hidráulico: 10L 20#
 Temperatura de trabajo: 5~40°C
 Humedad de trabajo: 30-95%
 Nivel de ruido: <76db

REF
9875

1080kg

1x

-  Elevador 2 colunas hidráulico chão livre 4T
 Elevador 2 columnas hidraulico suelo libre 4T

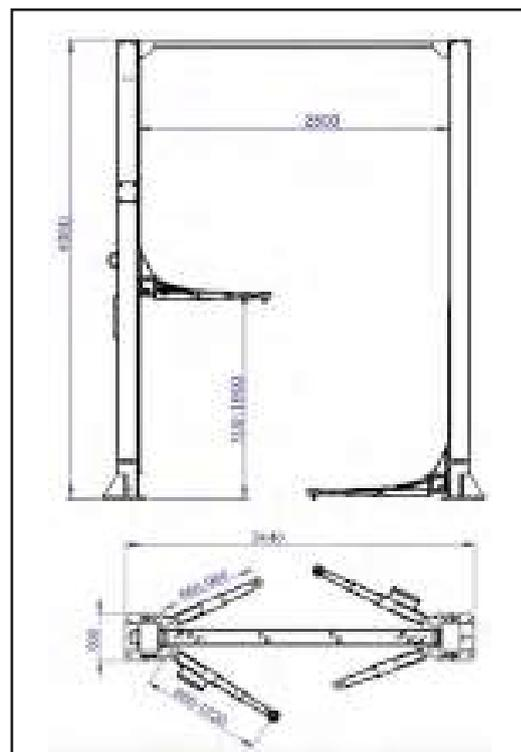

- ⓘ **Nota:** Em caso de atualização do modelo do elevador, consultar as medidas no site KROFtools
 ⓘ **Nota:** En caso de actualización del modelo del elevador, consultar las medidas en el sitio web de KROFtools

 **Características:**

Capacidade: 4T
 Elevação: 100-1900mm
 Altura total: 4050mm (4250mm com sensores)
 Pé direito exigido para a montagem: 4500mm
 Altura da barra limitadora: 3690mm
 Largura geral: 3440mm
 Largura entre colunas: 2800mm
 Alcance braço frontal: 660-960mm
 Alcance braço traseiro: 660-1220mm
 Potência: 2.2KW

 **Características:**

Capacidad: 4T
 Elevación: 100-1900mm
 Altura total: 4050mm (4250mm con sensores)
 Altura del techo necesaria para el montaje: 4500mm
 Altura da barra limitadora: 3690mm
 Anchura total: 3440mm
 Ancho entre columnas: 2800mm
 Alcance brazo delantero: 660-960mm
 Alcance brazo trasero: 660-1220mm
 Motor: 2.2KW

REF



9809
9809MO

380V
220V

766kg
766kg

1x
1x

-  Elevador duas colunas 4TON 380V wifi sync
-  Elevador 2 columnas 4TON 380V wifi sync

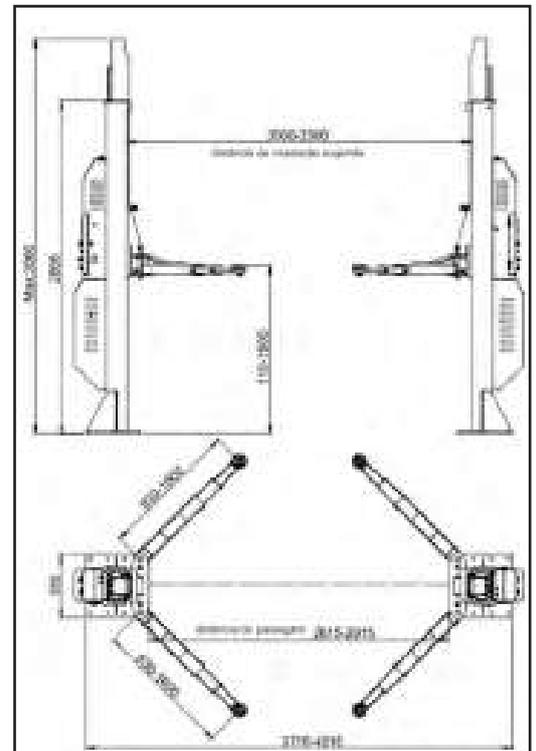

-  **Nota:** Em caso de atualização do modelo do elevador, consultar as medidas no site KROFtools
-  **Nota:** En caso de actualización del modelo del elevador, consultar las medidas en el sitio web de KROFtools

 **Características:**
 Capacidade: 4T
 Altura de elevação: 1900mm
 Altura original: 1100mm
 Tempo de elevação: ≤40s
 Tempo de descida: ≤30s
 Largura total: 3716-4016mm
 Largura de passagem: 2615-2915mm
 Voltagem: 380V
 Potência: 2.2 KW*2
 Óleo hidráulico: 12L (6L para cada depósito de óleo) 46# óleo hidráulico altamente abrasivo
 Temperatura de trabalho: 5-40°C
 Humidade de trabalho: 30-95%
 Nível de ruído: < 76db
 Local de instalação: Interior

 **Características:**
 Capacidad: 4T
 Altura de elevación: 1900mm
 Altura original: 1100mm
 Tiempo de elevación: ≤40s
 Tiempo de descenso: ≤30s
 Anchura total: 3716-4016mm
 Anchura de paso: 2615-2915mm
 Voltaje: 380V
 Potencia: 2.2 KW*2
 Aceite hidráulico: 12L (6L para cada depósito de aceite) 46# de aceite hidráulico altamente abrasivo
 Temperatura de trabajo: 5-40°C
 Humedad de trabajo: 30-95%
 Nivel de ruido: < 76db
 Lugar de instalación: Interior

REF
9876

877kg

1x

 Braço articulado 3 extensões para 9876
 Brazo articulado 3 extensiones para 9876

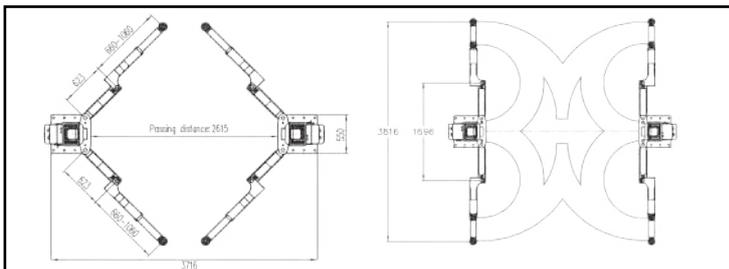

 **Características:**
Comprimento: 1683mm

 **Características:**
Longitud: 1683mm

REF



9876BA

140kg

1 x

 Adaptador agarra roda p/elevador 2 colunas
 Adaptador agarre de rueda

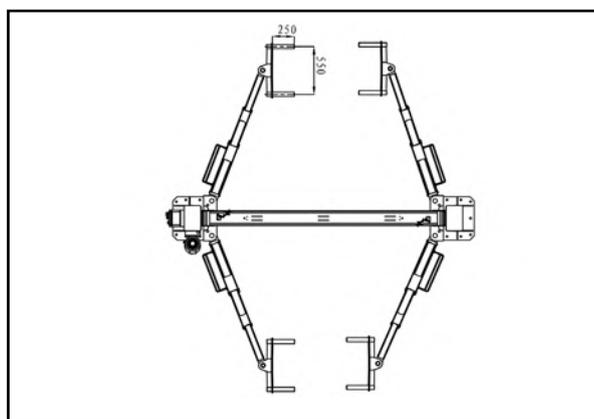

 **Características:**
Comprimento: 550mm
Largura: 250mm
Diâmetro do encaixe: 50mm

 **Características:**
Longitud: 550mm
Anchura: 250mm
Diámetro del racor: 50mm

REF



9798

48kg

1x

 Braço 3 extensões 830-1600mm
 Brazo de 3 extensiones 830-1600mm

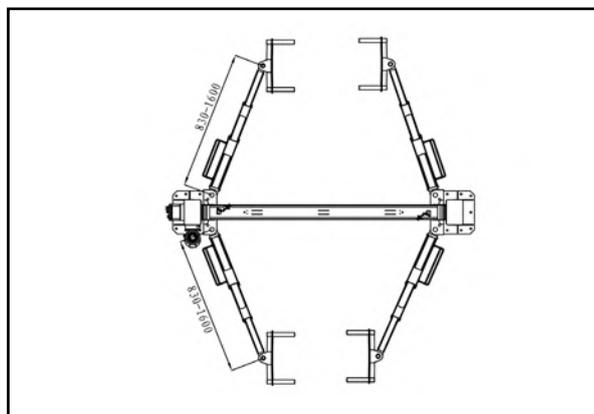

 **Características:**
Comprimento: 830-1600mm

 **Características:**
Longitud: 830-1600mm

NOTA: Compatível com Ref: 9809

NOTA: Compatible con Ref: 9809

REF



9799

188kg

1x

-  Elevador fuso 3,2T 2 colunas tipo-H 1 motor
-  Elevador huso 3.2T 2 columnas tipo-H 1 motor

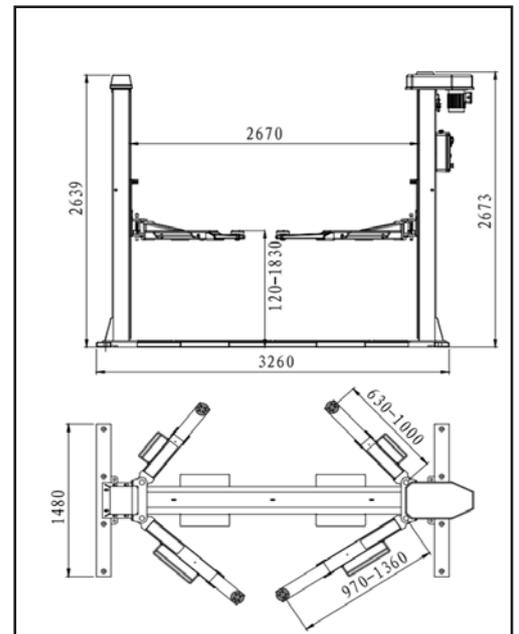
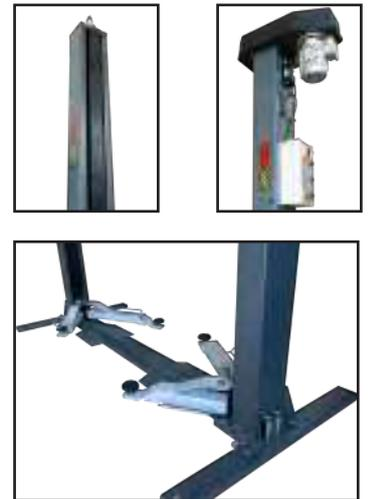

⚠ **Nota:** Em caso de atualização do modelo do elevador, consultar as medidas no site KROFtools

⚠ **Nota:** En caso de actualización del modelo del elevador, consultar las medidas en el sitio web de KROFtools

Características:

- Capacidade máxima: 3.2T
- Tempo de elevação quando carregado: 57s
- Tempo de descida quando carregado: 51s
- Altura útil máxima: 1830mm
- Intervalo de ajuste do suporte de borracha: 105mm
- Distância entre colunas: 2670mm
- Altura máxima de elevação: 2673mm
- Comprimento elevador: 1480mm
- Motor elétrico: 380V
- Potência motor: 3,6KW
- Voltagem: 24V
- Ruído: 71,6db
- Local de instalação: Interior

Características:

- Capacidad máxima: 3.2T
- Tiempo de elevación con carga: 57s
- Tiempo de descenso con carga: 51s
- Altura máxima de elevación: 1830mm
- Rango de ajuste del soporte de goma: 105mm
- Distancia entre columnas: 2670mm
- Altura máxima de elevación: 2673mm
- Anchura elevador: 1480mm
- Motor eléctrico: 380V
- Potencia del motor: 3,6KW
- Tensión: 24V
- Ruído: 71,6db
- Lugar de instalación: Interior

REF

9845



770,83kg



1x

-  Elevador 2 colunas eletro hidráulico 4T tipo H
 Elevador 2 columnas electro hidráulico 4T tipo H

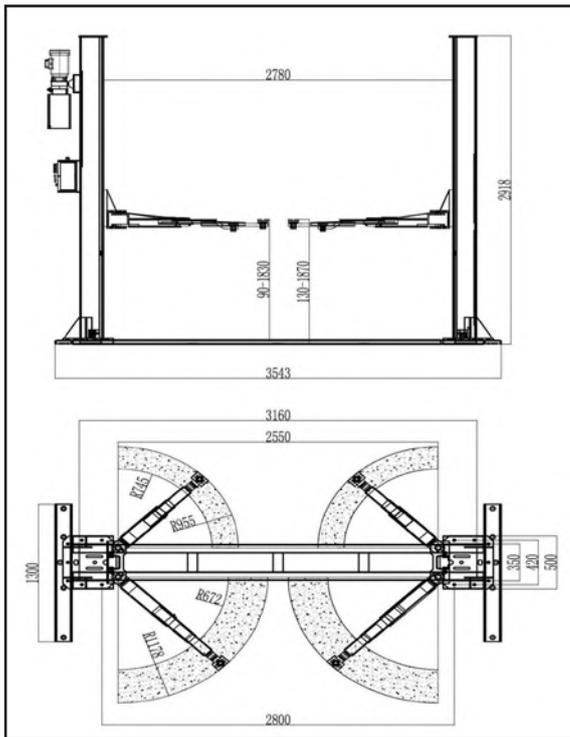

- ⚠ **Nota:** Em caso de atualização do modelo do elevador, consultar as medidas no site KROFtools
 ⚠ **Nota:** En caso de actualización del modelo del elevador, consultar las medidas en el sitio web de KROFtools

 **Características:**
 Capacidade máxima: 4T
 Altura plataformas: 90-1830mm / 130-1870mm
 Tempo subida: <50s
 Tempo descida: <60s
 Largura entre colunas: 2780mm
 Largura total: 3543mm
 Potência: 2,2KW
 Humidade trabalho: 30-95%
 Óleo hidráulico: 7L H46
 Ruído: < 76db
 Temperatura armazenamento: -25°C~55°C
 Local instalação: Interior

 **Características:**
 Capacidad máxima: 4T
 Altura de la plataforma: 90-1830mm / 130-1870mm
 Tiempo de subida: <50s
 Tiempo de descenso: <60s
 Ancho entre columnas: 2780mm
 Ancho total: 3543mm
 Potencia: 2,2KW
 Humedad trabajo: 30-95%
 Aceite hidráulico: 7L H46
 Ruido: <76db
 Temperatura almacenamiento: -25°C~55°C
 Local instalación: Interior

REF



9807
9807MO

380V
220V

755kg
755kg

1x
1x

-  Elevador 2 colunas 4T - Basic-line
-  Elevador 2 columnas 4T - Basic line

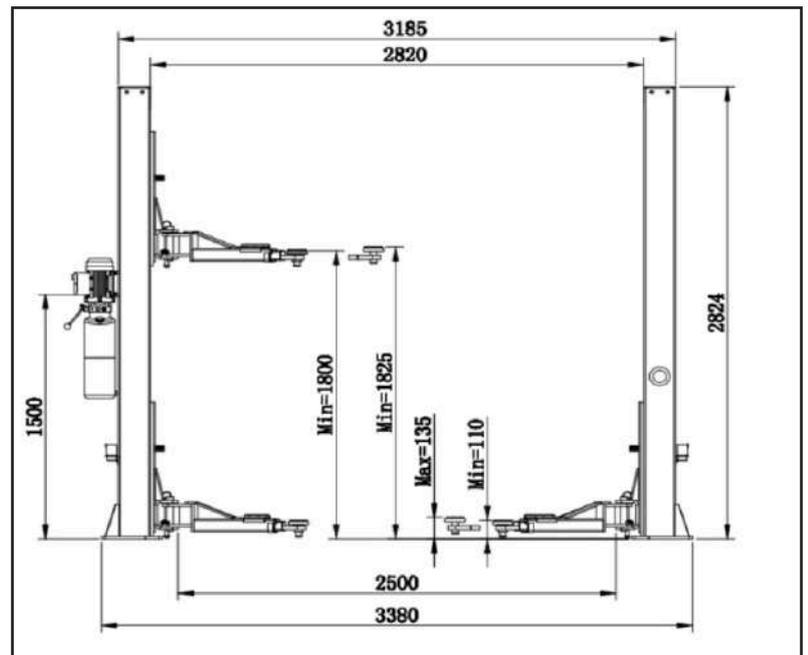
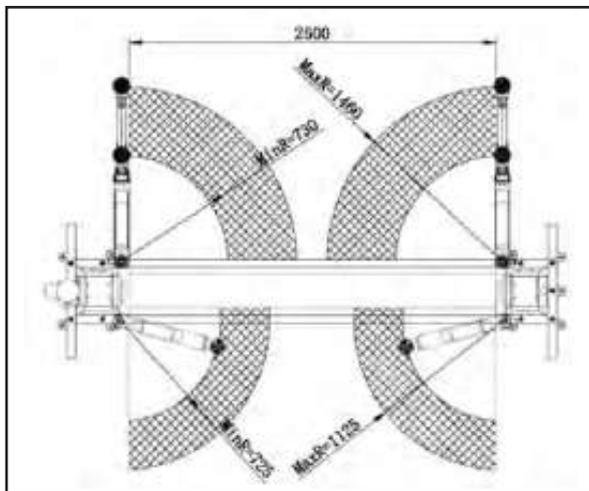

- ① **Nota:** Em caso de atualização do modelo do elevador, consultar as medidas no site KROftools
- ① **Nota:** En caso de actualización del modelo del elevador, consultar las medidas en el sitio web de KROftools

 **Características:**
 Capacidade de elevação: 4.0T
 Tempo de elevação: 40-60s
 Altura total: 2824mm
 Largura total: 3185mm
 Entre colunas: 2820mm
 Largura de passagem: 2500mm

 **Características:**
 Capacidad de elevación: 4.0T
 Tiempo de elevación: 40-60s
 Altura total: 2824mm
 Anchura total: 3185mm
 Entre columnas: 2820mm
 Ancho de paso: 2500mm

REF
9802

220V

530kg

1x

 Elevador 4 Colunas 6.5ton 5.5M P/Lisas

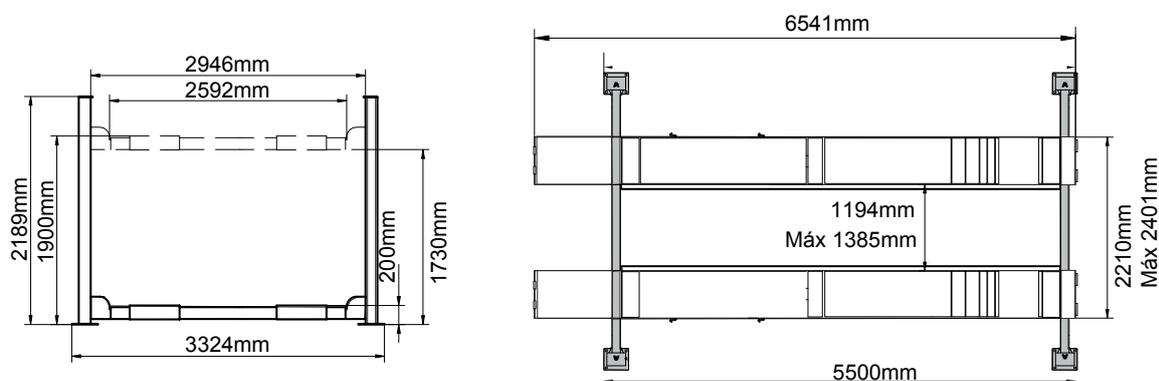
 Elevador 4 Columna 6.5ton 5.5M p/lisas

① **Nota:** Em caso de atualização do modelo do elevador, consultar as medidas no site KROFtools

① **Nota:** En caso de actualización del modelo del elevador, consultar las medidas en el sitio web de KROFtools

Características:

Capacidade de elevação: 6500Kg
 Altura de elevação: 1900mm
 Tempo de Levantamento: 65s
 Comprimento total (Inc. Rampas): 6541mm
 Largura total: 3324mm
 Largura Entre Colunas: 2946mm
 Motor: 4.0CV

Características:

Capacidad de elevación: 6500Kg
 Altura de elevación: 1900mm
 Tiempo de elevación: 65s
 Longitud total (con rampas): 6541mm
 Anchura total: 3324mm
 Anchura entre columnas: 2946mm
 Motor: 4.0CV

REF

9842



1268kg



1x

-  Elevador 4 columnas 4.5T 4,65m plataformas lisas
-  Elevador 4 columnas 4.5T 4,65m plataformas lisas

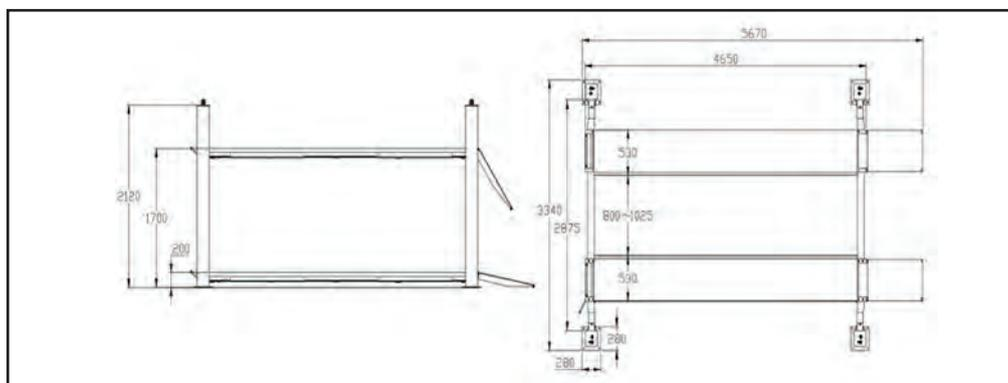
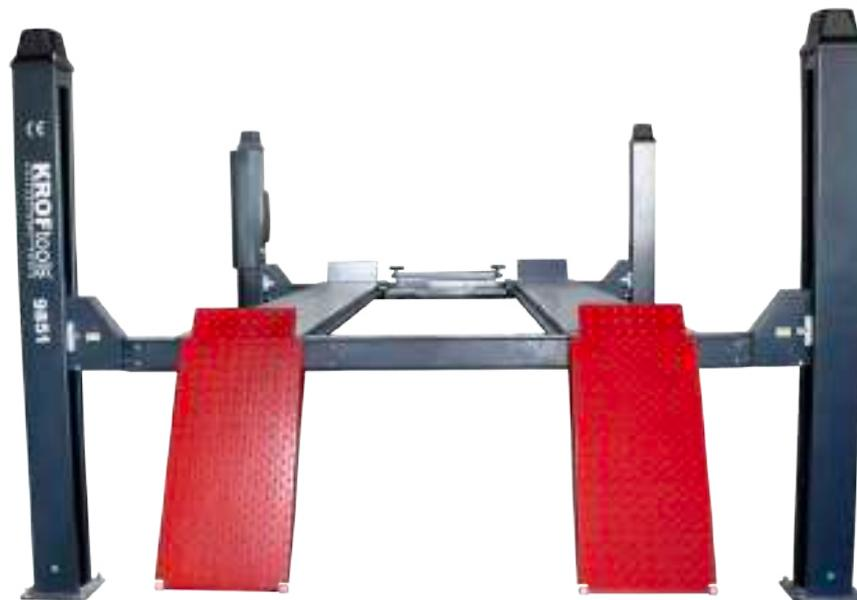

- ① **Nota:** Em caso de atualização do modelo do elevador, consultar as medidas no site KROftools
- ① **Nota:** En caso de actualización del modelo del elevador, consultar las medidas en el sitio web de KROftools

Características:
 Peso máximo elevação: 4.5T
 Altura elevação: 1700mm
 Altura inicial plataforma: 200mm
 Comprimento plataforma: 4650mm
 Largura plataforma: 530mm
 Tempo elevação: ≤45S
 Tempo descida: ≤30S
 Largura total: 3340mm
 Comprimento total: 5670mm
 Potência: 3/N/PE~380V, 50Hz, 10A
 Óleo hidráulico: 10L 20#
 Pressão: 6-8Kg/cm²
 Temperatura: 5-40°C
 Humidade: 30-95%
 Ruído: <76db
NOTA: Elevador compatível com Macaco central Ref: 9855

Características:
 Peso máximo de elevación: 4.5T
 Altura de elevación: 1700mm
 Altura de inicio de la plataforma: 200mm
 Longitud de la plataforma: 4650mm
 Ancho de la plataforma: 530 mm
 Tiempo de elevación: ≤45S
 Tiempo de descenso: ≤30S
 Anchura total: 3340 mm
 Longitud total: 5670mm
 Potencia: 3/N/PE~380V, 50Hz, 10^a
 Aceite hidráulico: 10L 20#
 Presión: 6-8Kg/cm²
 Temperatura: 5-40°C
 Humedad: 30-95%.
 Ruido: <76db
NOTA: Elevador compatible con gato central Ref: 9855

REF
9851

1000kg

1x

 Elevador 4 colunas 5T 5.19m plataformas lisas

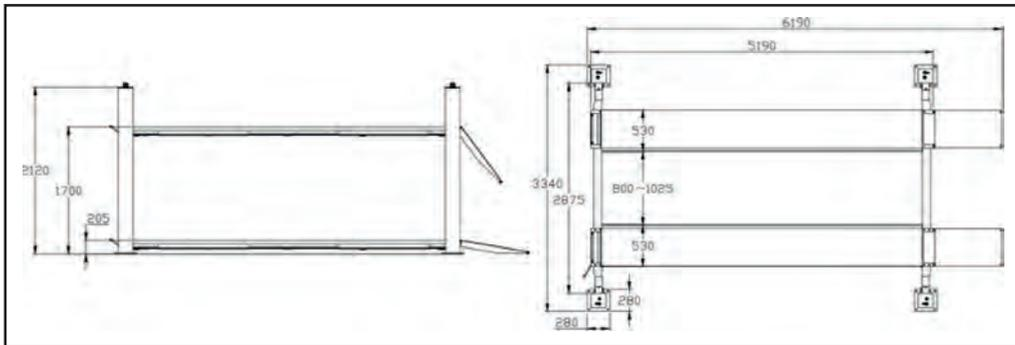
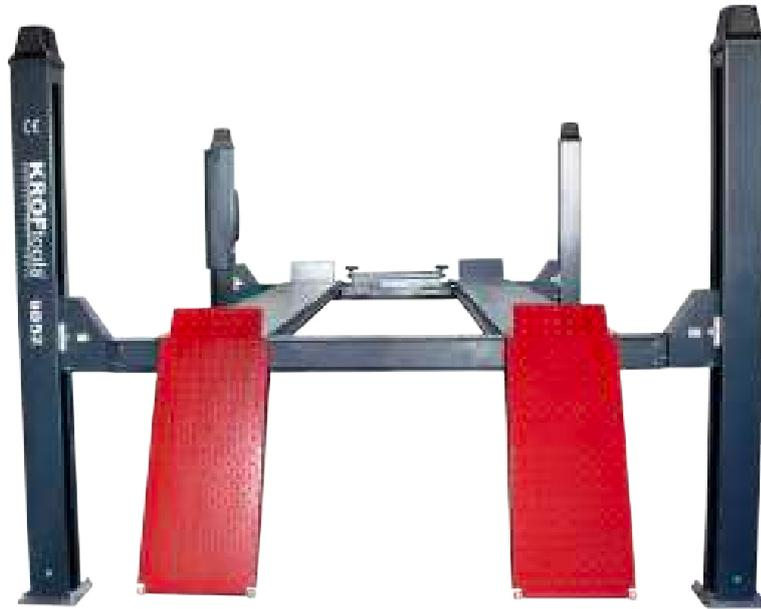
 Elevador 4 columnas 5T 5.19m plataformas lisas

- ① **Nota:** Em caso de atualização do modelo do elevador, consultar as medidas no site KROFtools
- ① **Nota:** En caso de actualización del modelo del elevador, consultar las medidas en el sitio web de KROFtools

 **Características:**

Peso máximo elevação: 5T
 Altura de elevação: 1700mm
 Altura inicial plataforma: 205mm
 Comprimento plataforma: 5190mm
 Largura plataforma: 530mm
 Tempo subida: ≤55S
 Tempo descida: ≤35S
 Largura total: 3340mm
 Comprimento total: 6190mm
 Potência: 3/N/PE~380V, 50Hz, 10A
 Óleo hidráulico: 10 L 20#
 Pressão: 6-8Kg/cm²
 Temperatura: 5-40°C
 Humidade: 30-95%
 Ruído: <76db

NOTA: Elevador compatível com Macaco central Ref: 9856

 **Características:**

Peso máximo de elevación: 5T
 Altura de elevación: 1700mm
 Altura inicial de la plataforma: 205mm
 Longitud de la plataforma: 5190mm
 Ancho de la plataforma: 530 mm
 Tiempo de ascenso: ≤55S
 Tiempo de descenso: ≤35S
 Anchura total: 3340 mm
 Longitud total: 6190 mm
 Potencia: 3/N/PE~380V, 50Hz, 10^a
 Aceite hidráulico: 10 L 20#
 Presión: 6-8Kg/cm²
 Temperatura: 5-40°C
 Humedad: 30-95%
 Ruido: <76db

NOTA: Elevador compatible con gato central Ref: 9856

REF

9852



1130kg



1x

 Elevador 4 columnas 4.65m 4.5t. P/ alinhamento trincos elétricos

 Elevador 4 columnas 4.5ton p/ alineamento 4.65m

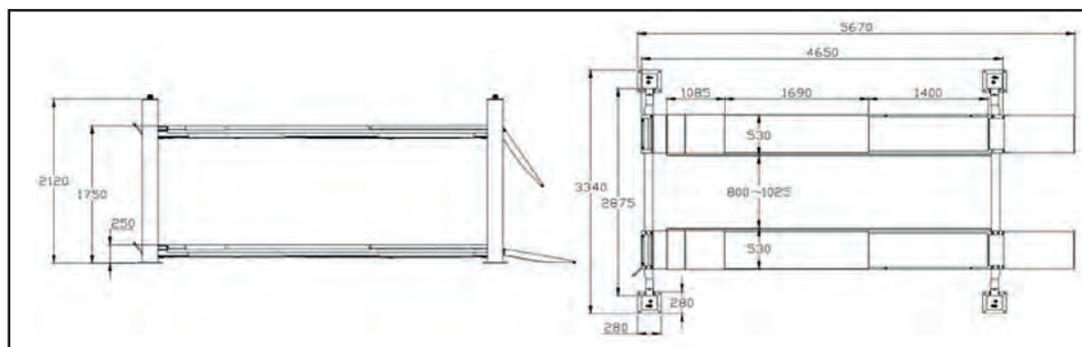

① **Nota:** Em caso de atualização do modelo do elevador, consultar as medidas no site KROFtools

① **Nota:** En caso de actualización del modelo del elevador, consultar las medidas en el sitio web de KROFtools

 **Características:**

Peso máximo elevação: 4,5T
 Altura elevação: 1750mm
 Altura inicial plataforma: 250mm
 Comprimento plataforma: 4650mm
 Largura plataforma: 530mm
 Tempo subida: ≤45S
 Tempo descida: ≤30S
 Largura total: 3340mm
 Comprimento total: 5670mm
 Potência: 3/N/PE~380V, 50Hz, 10^a
 Óleo hidráulico: 10L 20#
 Pressão: 6-8Kg/cm²
 Temperatura: 5-40°C
 Humidade: 30-95%
 Ruído: <76db

NOTA: Elevador compatível com Macaco central Ref: 9855

 **Características:**

Peso máximo de elevación: 4,5T
 Altura de elevación: 1750mm
 Altura de inicio de la plataforma: 250 mm
 Longitud de la plataforma: 4650mm
 Ancho de la plataforma: 530 mm
 Tiempo de subida: ≤45S
 Tiempo de descenso: ≤30S
 Anchura total: 3340 mm
 Longitud total: 5670mm
 Potencia: 3/N/PE~380V, 50Hz, 10^a
 Aceite hidráulico: 10L 20#
 Presión: 6-8Kg/cm²
 Temperatura: 5-40°C
 Humedad: 30-95%.
 Ruído: <76db

NOTA: Elevador compatible con gato central Ref: 9855

REF

9853



1200kg



1x

 Elevador 4 colunas 5.19m 5T para alinhamento trincos elétricos

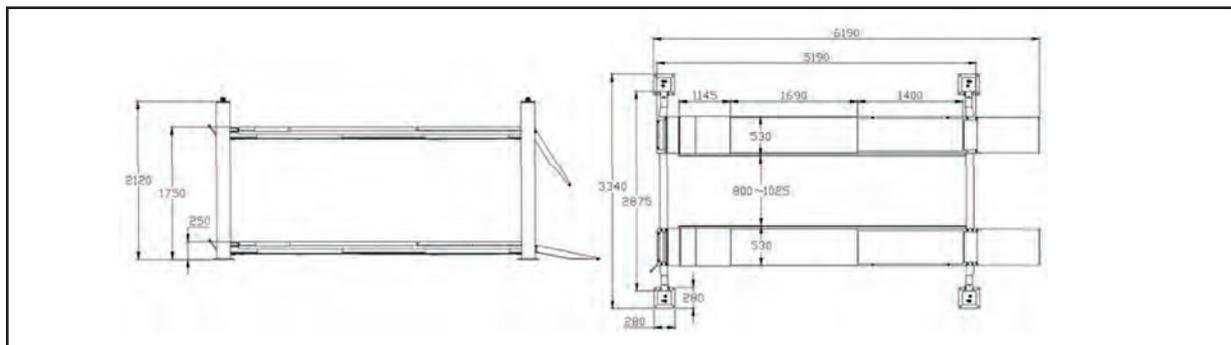
 Elevador 4 columnas 5T para alineamento 5.19m

① **Nota:** Em caso de atualização do modelo do elevador, consultar as medidas no site KROFtools

① **Nota:** En caso de actualización del modelo del elevador, consultar las medidas en el sitio web de KROFtools

 **Características:**

Peso máximo elevação: 5T
 Altura inicial: 250mm
 Altura de elevação: 1750mm
 Comprimento plataforma: 5190mm
 Largura plataforma: 530mm
 Tempo subida: ≤55S
 Tempo descida: ≤35S
 Largura total: 3340mm
 Comprimento total: 6160mm
 Potência: 3/N/PE~380V, 50Hz, 10^a
 Óleo hidráulico: 10L 20#
 Pressão: 6-8Kg/cm²
 Temperatura: 5-40°C
 Humidade: 30-95%
 Ruído: <76db

NOTA: Elevador compatível com Macaco central Ref: 9856

 **Características:**

Peso máximo de elevación: 5T
 Altura inicial: 250 mm
 Altura de elevación: 1750mm
 Longitud de la plataforma: 5190mm
 Ancho de la plataforma: 530 mm
 Tiempo de ascenso: ≤55S
 Tiempo de descenso: ≤35S
 Anchura total: 3340 mm
 Longitud total: 6160mm
 Potencia: 3/N/PE~380V, 50Hz, 10^a
 Aceite hidráulico: 10L 20#
 Presión: 6-8Kg/cm²
 Temperatura: 5-40°C
 Humedad: 30-95%.
 Ruído <76db

NOTA: Elevador compatible con gato central Ref: 9856

REF

9854



1379kg



1x

Macaco central para elevador 4 colunas 2T
Gato central elevador 4 columnas 2T



Características:
Funcionamento: elétrico
Capacidade de elevação: 2T
Altura de elevação: 485mm
Altura inicial: 215mm
Comprimento da plataforma: 730mm

Largura da plataforma: 260mm
Tempo de elevação: controlo manual
Tempo de descida: controlo manual
Comprimento total: 910mm
Largura total: 385mm

Compatível com os modelos 9851, 9853

Características:
Funcionamiento: eléctrico
Capacidad de elevación: 2T
Altura de elevación: 485mm
Altura inicial: 215mm
Longitud de la plataforma: 730mm
Ancho de la plataforma: 260mm

Tiempo de elevación: control manual
Tiempo de descenso: control manual
Longitud total: 910mm
Anchura total: 385mm

Compatible con los modelos 9851, 9853

REF



9855

121kg



1x

Macaco central para elevador de 4 columnas 2T
Gato central elevador 4 columnas 2T



Características:
Capacidade de elevação: 2T
Curso: 250mm
Altura mínima: 215mm
Altura máxima: 465mm
Largura: 780-1610mm
Profundidade: 445mm
Alimentação de ar: 0.8-1.2Mpa

Compatível com os elevadores com calha

Características:
Capacidad de elevación: 2T
Carrera: 250mm
Altura mínima: 215mm
Altura máxima: 465mm
Anchura: 780-1610mm
Profundidad: 445mm
Suministro de aire: 0.8-1.2Mpa

Compatible con elevadores de carriles

REF



9896

117kg



1x

Macaco central para elevador 4 colunas 3T
Gato central para elevador 4 columnas 3T



Características:
Funcionamento: elétrico
Capacidade de elevação: 3T
Altura de elevação: 485mm
Altura inicial: 215mm
Comprimento da plataforma: 730mm

Largura da plataforma: 260mm
Tempo de elevação: controlo manual
Tempo de descida: controlo manual
Comprimento total: 910mm
Largura total: 385mm

Compatível com os modelos 9852, 9854

Características:
Funcionamiento: eléctrico
Capacidad de elevación: 3T
Altura de elevación: 485mm
Altura inicial: 215mm
Longitud de la plataforma: 730mm
Ancho de la plataforma: 260mm

Tiempo de elevación: control manual
Tiempo de descenso: control manual
Longitud total: 910mm
Ancho total: 385mm

Compatible con los modelos 9852, 9854

REF



9856

138kg



1x

 Macaco central p/ elevador de 4 colunas 3T
 Gato central elevador 4 columnas 3T



-  **Características:**
 Capacidade de elevação: 3T
 Curso: 270mm
 Altura mínima: 252mm
 Altura máxima: 522mm
 Largura: 780-1610mm
 Profundidade: 445mm
 Alimentação de ar: 0.8-1.2Mpa
 Compatível com os elevadores com calha

-  **Características:**
 Capacidad de elevación: 3T
 Carrera: 270mm
 Altura mínima: 252mm
 Altura máxima: 522mm
 Anchura: 780-1610mm
 Profundidad: 445mm
 Suministro de aire: 0.8-1.2Mpa
 Compatible con elevadores de carriles

REF



9897

159kg

1x

 Macaco central para elevador 4 colunas 3,5T
 Gato central elevador 4 columnas 3,5T



-  **Características:**
 Capacidade de elevação: 3.5T
 Altura de elevação: 510mm
 Tempos de elevação: 50s
 Comprimento total: 1019mm
 Largura total: 526mm
 Altura mínima: 265mm
 Fonte de ar (Mpa): 0.5~0.8
 Compatível com o modelo REF 9842

-  **Características:**
 Capacidad de elevación: 3.5T
 Altura de elevación: 510mm
 Tiempos de elevación: 50s
 Longitud total: 1019mm
 Altura total: 526mm
 Altura mínima: 265mm
 Fuente de aire (Mpa): 0.5~0.8
 Compatible con lo modelo REF 9842

REF



9843

169kg

1x

 Macaco central p/ elevador 4 colunas 9T
 Gato central elevador 4 columnas 9T



-  **Características:**
 Capacidade de elevação: 9000kg
 Altura de elevação: 758-1054mm
 Tempos de elevação: 50s
 Comprimento total: 1153mm
 Largura total: 635mm
 Altura mínima: 367mm
 Fonte de ar (Mpa): 0.8
 Compatível com o modelo REF 9842

-  **Características:**
 Capacidad de elevación: 9000kg
 Altura de elevación: 758-1054mm
 Tiempos de elevación: 50s
 Longitud total: 1153mm
 Altura total: 635mm
 Altura mínima: 367mm
 Fuente de aire (Mpa): 0.8
 Compatible con lo modelo REF 9842

REF



9844

378kg

1x

Macaco central 2T para elevador 4 columnas
Gato central elevador 4 columnas 2ton



Características:
Peso máximo suportado: 2T
Altura elevação: 60-390mm
Abertura travessa apoio carro: 796-1600mm
Abertura rodas macaco: 800-1100mm

Características:
Peso máximo suportado: 2T
Altura de elevación: 60-390mm
Apertura travesa soporte coche: 796-1600mm
Apertura ruedas gato: 800-1100mm

REF



9828

115kg

1x

Macaco para fossa 15T
Viga elevadora 15T



Roda cônica p/ macacos de fossa
Rueda cónica para gatos de foso



REF 9891R

Características:
Capacidade de elevação: 15T
Curso: 200mm
Altura mínima: 420mm
Altura máxima: 620mm
Largura: 600-1400mm
Profundidade: 665mm
Alimentação de ar: 0.75-1.2Mpa

Características:
Capacidad de elevación: 15T
Carrera: 200mm
Altura mínima: 420mm
Altura máxima: 620mm
Anchura: 600-1400mm
Profundidad: 665mm
Suministro de aire: 0.75-1.2Mpa

REF



9891

245kg

1x

Macaco para fossa 15T
Viga elevadora 15T



Roda cônica p/ macacos de fossa
Rueda cónica para gatos de foso



REF 9891R

Características:
Capacidade de elevação: 15T
Curso: 800mm
Altura mínima: 1020mm
Altura máxima: 1820mm
Largura: 600-1400mm
Profundidade: 665mm
Alimentação de ar: 0.75-1.2Mpa

Características:
Capacidad de elevación: 15T
Carrera: 800mm
Altura mínima: 1020mm
Altura máxima: 1820mm
Anchura: 600-1400mm
Profundidad: 665mm
Suministro de aire: 0.75-1.2Mpa

REF



9892

270kg

1x

Macaco para fossa 20T duplo pistão
 Viga elevadora 20T



Roda cônica p/ macacos de fossa
 Rueda cônica para gatos de foso



REF 9891R

Características:
 Capacidade de elevação: 20T
 Curso: 420mm
 Altura mínima: 576mm
 Altura máxima: 996mm
 Largura: 600-1400mm
 Profundidade: 665mm
 Alimentação de ar: 0.75-1.2 Mpa

Características:
 Capacidad de elevación: 20T
 Carrera: 420mm
 Altura mínima: 576mm
 Altura máxima: 996mm
 Anchura: 600-1400mm
 Profundidad: 665mm
 Suministro de aire: 0.75-1.2 Mpa

REF

9893



285kg



1x

Plataforma elevatória eletro-hidraulica 1.2T
 Plataforma elevadora eletro-hidraulica 1.2T



ⓘ **Nota:** Em caso de atualização do modelo do elevador, consultar as medidas no site KROFtools

ⓘ **Nota:** En caso de actualización del modelo del elevador, consultar las medidas en el sitio web de KROFtools

BORRACHA P/ PLATAFORMA 9839
 GOMA PARA PLATAFORMA 9839

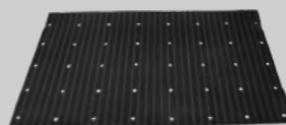

REF 9839BP

Kit 8 adaptadores suporte
 para plataforma elevatória
 Kit 8 adaptadores soporte
 para plataforma elevadora



REF 9841

Características:
 Capacidade de elevação: 1.2T
 Altura mínima: 570mm
 Altura máxima de elevação: 1920mm
 Comprimento da plataforma: 1300mm
 Largura da plataforma: 770mm
 Distância ao solo: 140mm
 Movimento de direção do eixo X: 50mm
 Movimento de direção do eixo Y: 50mm
 Inclinação da plataforma no eixo X: 5°
 Inclinação da plataforma no eixo Y: 5°
 Potência: 2,2kW
 Tempo de elevação com carga: 60s
 Tempo de descida com carga: 40s
 Energia: 220V/50Hz/1Ph

Características:
 Capacidad de elevación: 1.2T
 Altura mínima: 570mm
 Altura máxima de elevación: 1920mm
 Longitud de la plataforma: 1300mm
 Ancho de la plataforma: 770mm
 Distancia al suelo: 140mm
 Movimiento de la dirección del eje X: 50mm
 Movimiento de la dirección del eje Y: 50mm
 Inclinación de la plataforma en el eje X: 5°
 Inclinación de la plataforma en el eje Y: 5°
 Potencia: 2,2kW
 Tiempo de elevación con carga: 60s
 Tiempo de descenso con carga: 40s
 Energia: 220V/50Hz/1Ph

REF

9839



379kg



1x

 Elevador tipo esteira de 3T
 Elevador 3T



⚠ **Nota:** Em caso de atualização do modelo do elevador, consultar as medidas no site KROFtools

⚠ **Nota:** En caso de actualización del modelo del elevador, consultar las medidas en el sitio web de KROFtools

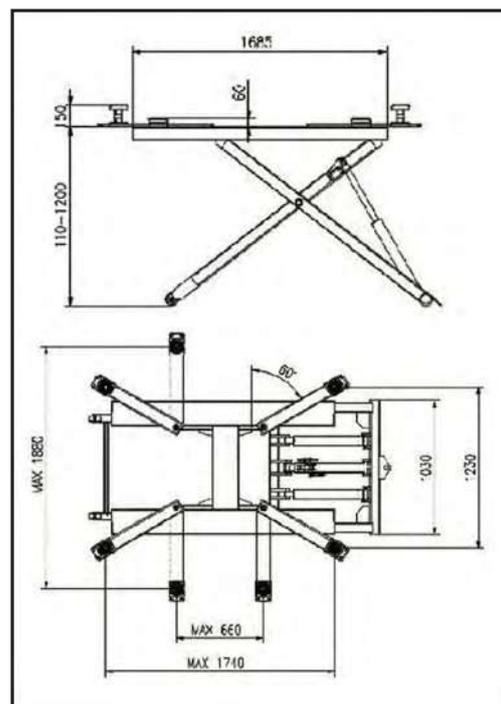

 **Características:**

- Capacidade: 3T
- Altura máxima elevação: 1200mm
- Altura máxima elevação com adaptadores: 1350mm
- Altura mínima: 110mm
- Comprimento total: 2230mm
- Largura total: 1080mm
- Tempo de subida: ≤ 35s
- Tempo de descida: ≤ 25s
- Voltagem: AC 220V±5% 60Hz
- Potência: 2.2KW
- Óleo hidráulico: 12L
- Temperatura trabalho: 5-40°C
- Humidade trabalho: 30-95°C
- Ruído: < 76db
- Altitude instalação: 1000m
- Temperatura armazenamento: -25°C~55°C

 **Características:**

- Capacidad: 3T
- Altura máxima de elevación: 1200mm
- Altura máxima de elevación con adaptadores: 1350mm
- Altura mínima: 110mm
- Longitud total: 2230 mm
- Anchura total: 1080 mm
- Tiempo de subida: ≤ 35s
- Tiempo de descenso: ≤ 25s
- Alimentación: 220V±5% 60Hz
- Potencia: 2.2KW
- Aceite hidráulico: 12L
- Temperatura de trabajo: 5-40°C
- Humedad de trabajo: 30-95°C
- Nivel de ruido: < 76db
- Altitud de instalación: 1000m
- Temperatura de almacenamiento: -25°C~55°C

REF

9830



432kg



1x

 Elevador tesoura baixo perfil 1 plataforma 3T

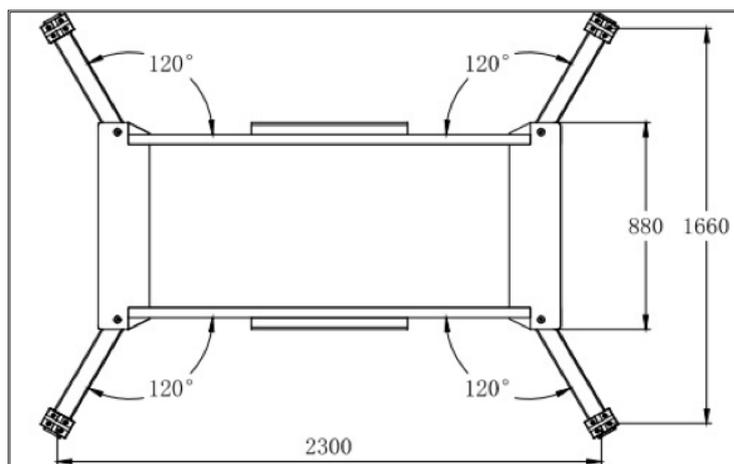
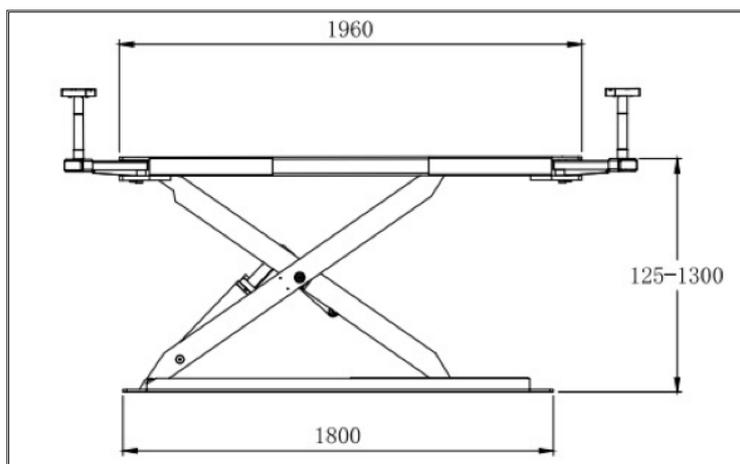
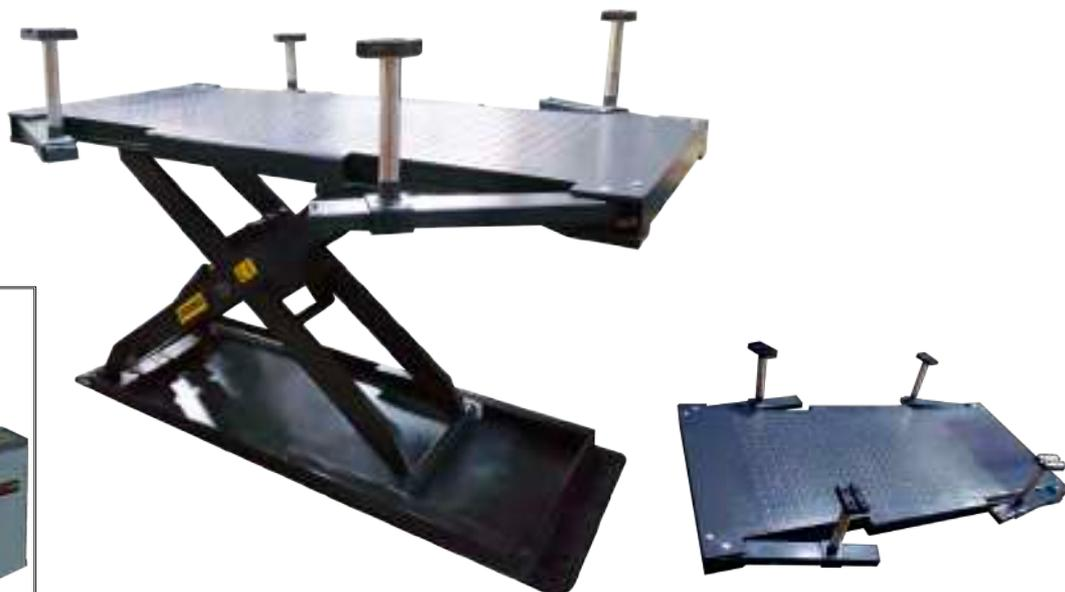
 Elevador tijera bajo perfil 1 plataforma 3T

① **Nota:** Em caso de atualização do modelo do elevador, consultar as medidas no site KROFtools

① **Nota:** En caso de actualización del modelo del elevador, consultar las medidas en el sitio web de KROFtools

 **Características:**

Sistema de controlo: Eléctrico Hidráulico
 Peso máximo elevação: 3T
 Altura elevação: 1300mm
 Altura inicial plataforma: 125mm
 Comprimento plataforma: 1900mm
 Largura plataforma: 880mm
 Tempo elevação: < 50s
 Tempo descida: < 60s
 Potência: 2.2kw
 Óleo hidráulico: 12L óleo hidráulico
 Pressão ar: 4-6kg/cm²
 Temperatura funcionamento: 5-40°C
 Humidade funcionamento: 30-95%
 Temperatura armazenamento: -25°C~55°C
 Local instalação: Interior
 Ruído: < 76db

 **Características:**

Sistema de control: Eléctrico hidráulico
 Peso elevación: 3T
 Altura de elevación: 1300mm
 Altura inicial de la plataforma: 125mm
 Longitud de la plataforma: 1900mm
 Ancho de plataforma: 880mm
 Tiempo de elevación: < 50s
 Tiempo de descenso: < 60s
 Poder: 2.2kw
 Aceite hidráulico: aceite hidráulico 12L
 Presión de aire: 4-6kg/cm²
 Temperatura de funcionamiento: 5-40°C
 Humedad de funcionamiento: 30-95%
 Temperatura de almacenamiento: -25°C~ 55°C
 Lugar de instalación: Interior
 Ruído: <76db

REF

9819



628kg



1x

 Elevador portátil 2.5T
 Elevador portatil 2.5T



 **Nota:** Em caso de atualização do modelo do elevador, consultar as medidas no site KROFtools

 **Nota:** En caso de actualización del modelo del elevador, consultar las medidas en el sitio web de KROFtools

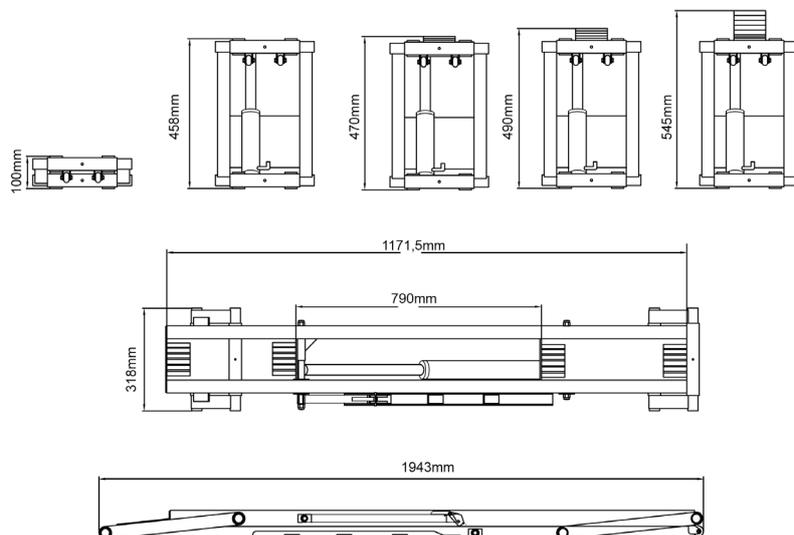

 **Características:**
 Voltagem nominal: 220 V ~ 50Hz
 Potência: 750W
 Capacidade de elevação: 2500Kg
 Altura mínima: 100mm
 Altura máxima de elevação: 458mm
 Altura elevação: 560/580mm
 Óleo hidráulico: volume 2L
 Óleo hidráulico, tipo ISO 32 ou ISO 46

NOTA: As estruturas de elevação não podem ser colocadas à altura mínima porque precisam de espaço para para acumular a pressão hidráulica

 **Características:**
 Tensión nominal: 220V ~ 50Hz
 Potencia: 750W
 Capacidad de elevación: 2500Kg
 Altura mínima: 100mm
 Altura máxima de elevación: 458mm
 Altura de elevación: 560/580mm
 Aceite hidráulico: Volumen 2L
 Aceite hidráulico: Tipo ISO 32 o ISO 46

NOTA: Los bastidores de elevación no pueden elevarse a la altura mínima porque necesitan espacio para acumular presión hidráulica

REF
9812

118kg

1x

 Elevador tesoura embutir hidráulico 3.5T

 Elevador tijera hidráulico empotrable 3.5T

Medidas caixa comandos:

460×300×980mm

Medidas caja de comandos:

460×300×980mm

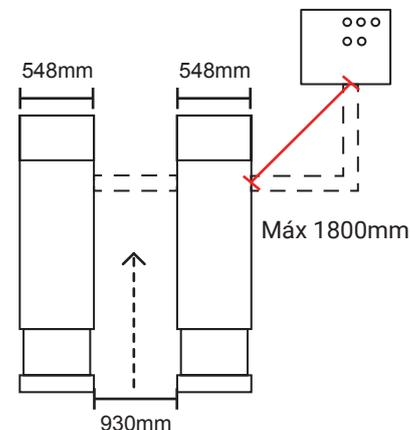
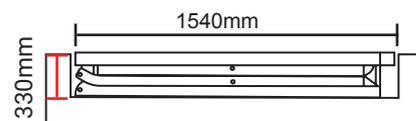
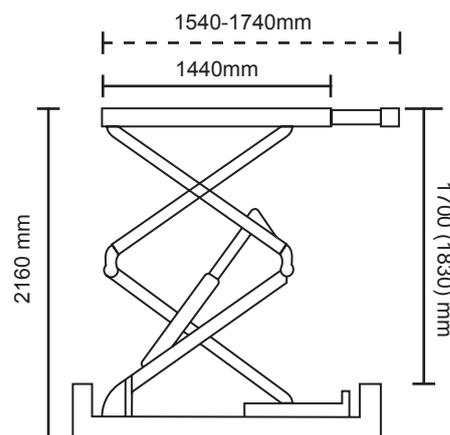
 Borracha 180x180x40mm
 Goma 180x180x40mm

REF 981015B18040

 Borracha 180x180x80mm
 Goma 180x180x80mm

REF 981015B18080

⚠ **Nota:** Em caso de atualização do modelo do elevador, consultar as medidas no site KROFtools

⚠ **Nota:** En caso de actualización del modelo del elevador, consultar las medidas en el sitio web de KROFtools

 **Características:**

Sistema controlo: Eléctrico hidráulico
 Peso máximo permitido: 3.5T
 Altura máxima elevação: 2030mm (2160mm)
 Altura inicial plataforma: 330mm
 Comprimento plataforma: 1540-1740mm
 Largura plataforma: 548mm
 Tempo subida: ≤50s
 Tempo descida: ≤60s
 Comprimento total elevador: 1540mm
 Largura total elevador: 2016mm
 Fonte de alimentação: AC 380V ±5% 50Hz / AC 220V ±5% 50Hz
 Potência: 2.2kw
 Óleo hidráulico: 20L
 Pressão de ar: 6-8kg/cm²
 Temperatura trabalho: 5-40°C
 Humidade trabalho: 30-95%
 Nível ruído: < 76db
 Temperatura armazenamento: -25°C~55°C

 **Características:**

Sistema de control: Eléctrico hidráulico
 Peso máximo permitido: 3.5T
 Altura máxima de elevación: 2030mm (2160mm)
 Altura inicial de la plataforma: 330mm
 Longitud de la plataforma: 1540-1740mm
 Anchura de la plataforma: 548mm
 Tiempo de ascenso: ≤50s
 Tiempo de descenso: ≤60s
 Longitud total del elevador: 1540mm
 Anchura total del elevador: 2016mm
 Alimentación: AC 380V ±5% 50Hz / AC 220V ±5% 50Hz
 Potencia: 2.2kw
 Aceite hidráulico: 20L
 Presión de aire: 6-8kg/cm²
 Temperatura de trabajo: 5-40°C
 Humedad de trabajo: 30-95%
 Nivel de ruido: < 76db
 Temperatura almacenamiento: -25°C~55°C

REF



 9810
 9810MO

 380V
 220V

 773kg
 773kg

 1x
 1x

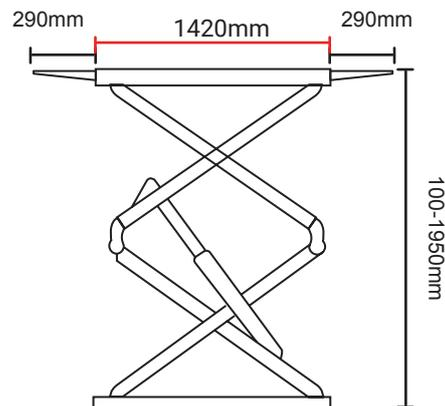
-  Elevador de tesoura chão hidráulico 3T
-  Elevador de tijera suelo hidráulico 3T



Medidas caixa comandos:
460×300×980mm

Medidas caja de comandos:
460×300×980mm

Borracha 180x180x40mm
Goma 180x180x40mm



REF 981015B18040

Borracha 180x180x80mm
Goma 180x180x80mm



REF 981015B18080

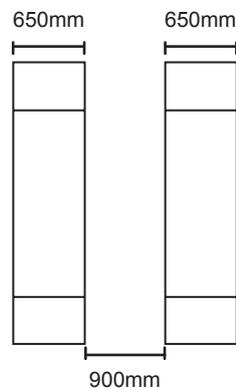

Nota: Em caso de atualização do modelo do elevador, consultar as medidas no site KROFtools

Nota: En caso de actualización del modelo del elevador, consultar las medidas en el sitio web de KROFtools

- Características:**
- Funcionamento: Eléctrico hidráulico
 - Peso suportado: 3T
 - Altura elevação: 1950mm
 - Altura inicial plataforma: 100mm
 - Comprimento plataforma: 1420mm
 - Largura plataforma: 650mm
 - Tempo subida: ≤50s
 - Tempo descida: ≤60s
 - Comprimento total: 2010mm
 - Largura total: 2200mm
 - Voltagem: AC 380V / AC 220V
 - Potência: 2.2kw
 - Óleo hidráulico: 18L
 - Temperatura de funcionamento: 5-40°C
 - Humidade trabalho: 30-95%
 - Ruído: < 76db
 - Temperatura armazenamento: -25°C~55°C
 - Local instalação: Interior

- Características:**
- Sistema de control: Eléctrico hidráulico
 - Peso suportado: 3T
 - Altura de elevación: 1950mm
 - Plataforma de altura inicial: 100mm
 - Longitud de la plataforma: 1420mm
 - Ancho de la plataforma: 650mm
 - Tiempo de subida: ≤50s
 - Tiempo de descenso: ≤60s
 - Longitud total: 2010mm
 - Ancho total: 2200mm
 - Voltaje: AC 380V / AC 220V
 - Potencia: 2.2kw
 - Aceite hidráulico: 18L
 - Temperatura de funcionamiento: 5-40°C
 - Humedad trabajo: 30-95%
 - Ruído: <76db
 - Temperatura almacenamiento: -25°C~55°C
 - Instalación local: Interior

REF	⚡	⚖️	📦
9815	380V	952kg	1x
9815M	220V	952kg	1x

 Elevador de tesoura chão hidráulico 3T 1M elevação

 Elevador tijera 3T 1M de elevación

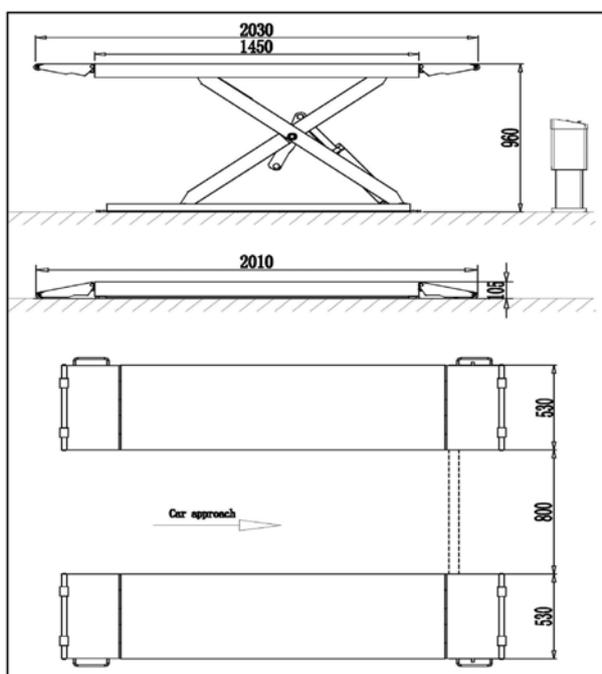

Nota: Em caso de atualização do modelo do elevador, consultar as medidas no site KROFtools

Nota: En caso de actualización del modelo del elevador, consultar las medidas en el sitio web de KROFtools

Medidas caixa comandos:
460×300×980mm

Medidas caja de comandos:
460×300×980mm

Características:

- Potência: 2.2kw
- Tipo: Y90L
- Comprimento plataformas: 1450mm
- Comprimento total: 2030mm
- Altura inicial das plataformas: 105mm
- Altura máxima de elevação: 960mm
- Energia: 380V: 5A / 220V: 5A
- Polos: 4
- Velocidade: 1450rpm
- Forma de construção: B14
- Classe isolamento: F

Características:

- Potencia: 2.2kw
- Tipo: Y90L
- Longitud plataformas: 1450mm
- Longitud total: 2030mm
- Altura inicial de las plataformas: 105mm
- Altura máxima de elevación: 960mm
- Energía: 380V: 5A / 220V: 5A
- Polos: 4
- Velocidad: 1450rpm
- Forma de construcción: B14
- Clase aislamiento: F

REF	⚡	⚖️	📄
9818	380V	591kg	1x
9818MO	220V	591kg	1x

-  Elevador de tesoura chão hidráulico amovível 3T
-  Elevador tijera amovible 3T

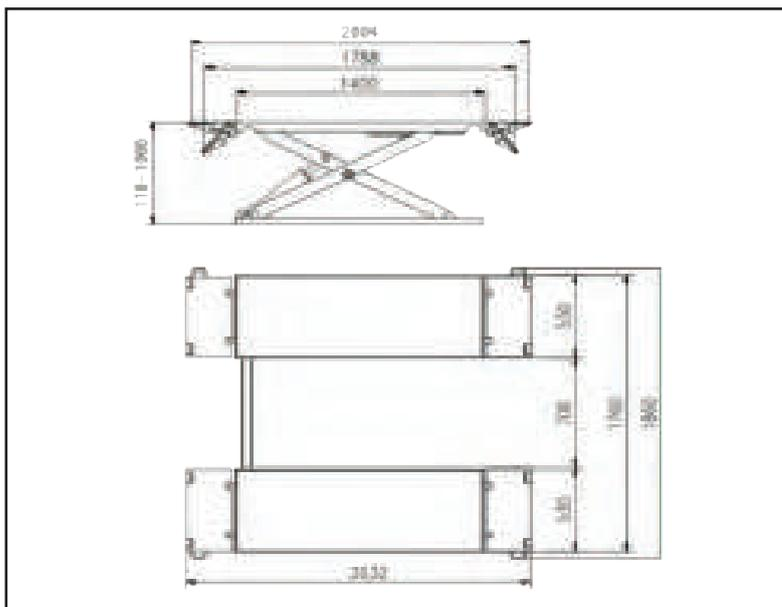

⚠ **Nota:** Em caso de atualização do modelo do elevador, consultar as medidas no site KROFtools

⚠ **Nota:** En caso de actualización del modelo del elevador, consultar las medidas en el sitio web de KROFtools

Medidas caixa comandos:
360×330×980mm

Medidas caja de comandos:
360×330×980mm

 **Características:**
 Capacidade de elevação: 3T
 Altura máx. de elevação: 1000mm
 Altura mínima: 110mm
 Largura total: 1760mm
 Comprimento da plataforma: 1400-2004mm
 Espaço entre plataformas: 700mm
 Tempo de elevação: 60 seg
 Ruído 70db (A): 1m
 Temperatura de funcionamento: 10°C - +50°C
 Ambiente de trabalho: Espaço fechado
 Fonte de alimentação: 2.2KW 200-240V 50/60Hz 1Ph

 **Características:**
 Capacidad de elevación: 3T
 Altura máxima de elevación: 1000mm
 Altura mínima: 110mm
 Anchura total: 1760mm
 Longitud de la plataforma: 1400-2004mm
 Espacio entre plataformas: 700mm
 Tiempo de elevación: 60s
 Ruído: 70db (A) 1m
 Temperatura de funcionamiento: 10°C - +50°C
 Entorno de trabajo: Espacio cerrado
 Alimentación: 2,2KW, 200-240V 50/60Hz 1Ph

REF
9817

523,1kg

1x

 Elevador dupla tesoura para alinhamento com LED 5.5T

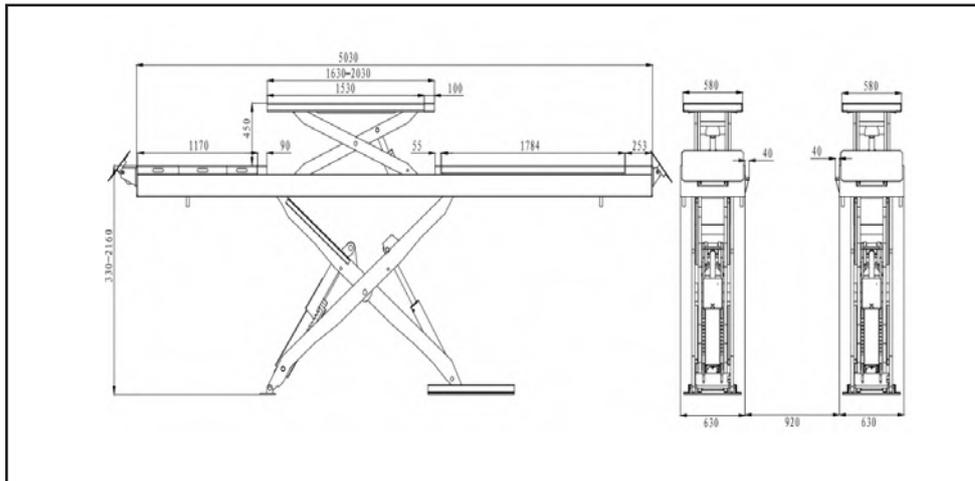
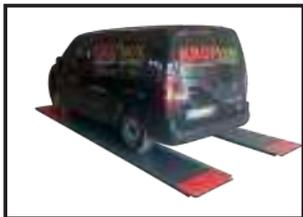
 Elevador doble tijera para alineamiento con LED 5.5T

ⓘ **Nota:** Em caso de atualização do modelo do elevador, consultar as medidas no site KROFtools

ⓘ **Nota:** En caso de actualización del modelo del elevador, consultar las medidas en el sitio web de KROFtools

Medidas caixa comandos:
460×300×980mm

Medidas caja de comandos:
460×300×980mm

Características:

Capacidade: 5.5T
 Sistema de Controlo: Eléctrico Hidráulico
 Altura elevação plataforma principal: 2160mm
 Altura elevação plataforma secundária: 450mm
 Altura inicial: 330mm
 Comprimento plataforma principal: 5030mm
 Comprimento plataforma secundária: 1630-2030mm
 Largura plataforma principal: 630mm
 Largura plataforma secundária: 580mm
 Tempo elevação plataforma principal: 50s
 Tempo descida plataforma principal: 60s
 Tempo elevação plataforma secundária: 20s
 Tempo descida plataforma secundária: 30s
 Largura total: 2160mm
 Comprimento total: 5510mm
 Ruído: 76db

Características:

Capacidad: 5.5T
 Sistema de control: Eléctrico hidráulico
 Altura de elevación de la plataforma principal: 2160mm
 Altura de elevación de la plataforma secundária: 450mm
 Altura inicial: 330mm
 Longitud de la plataforma principal: 5030mm
 Longitud de la plataforma secundária: 1630-2030mm
 Ancho de la plataforma principal: 630mm
 Ancho de la plataforma secundária: 580mm
 Tiempo de elevación plataforma principal: 50s
 Tiempo descenso plataforma principal: 60s
 Tiempo elevación plataforma secundária: 20s
 Tiempo descendente plataforma secundária: 30s
 Ancho total: 2160mm
 Longitud total: 5510mm
 Ruido: 76dB

REF

9822



2968kg



1x

 Elevador dupla tesoura para alinhamento com LED 3,5T

 Elevador doble tijera para alineamiento con LED 3,5T

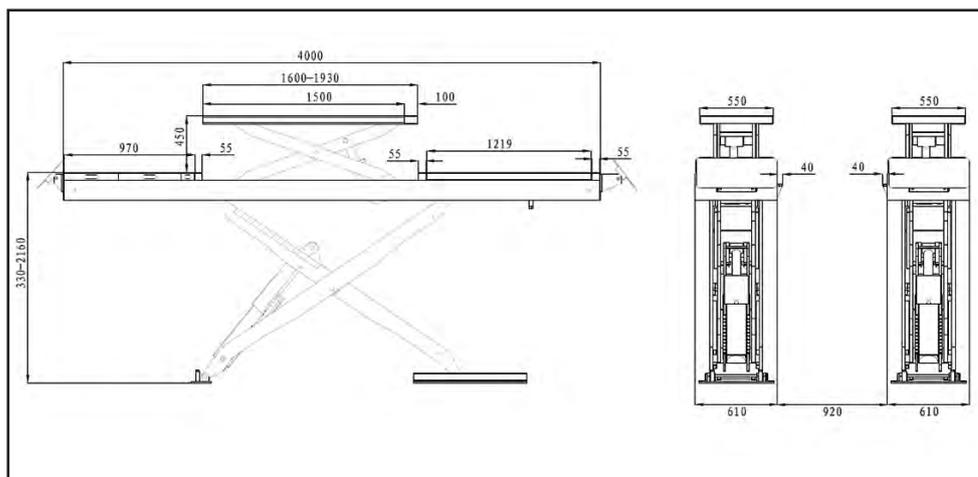
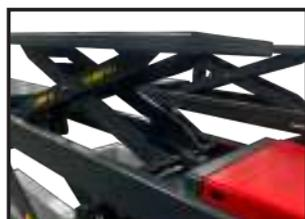
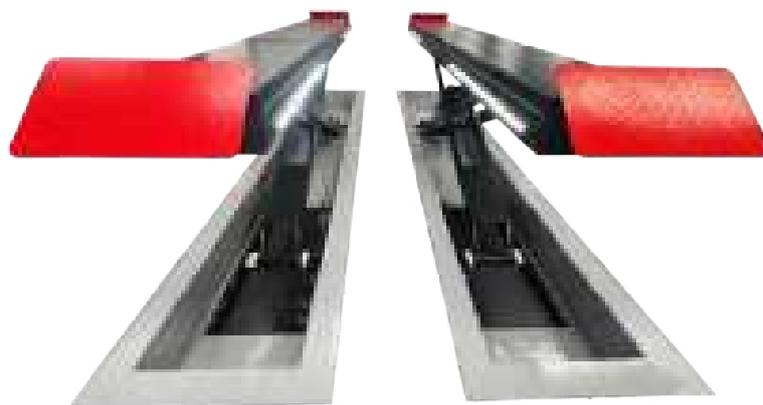

ⓘ **Nota:** Em caso de atualização do modelo do elevador, consultar as medidas no site KROFtools

ⓘ **Nota:** En caso de actualización del modelo del elevador, consultar las medidas en el sitio web de KROFtools

Medidas caixa comandos:
460×300×980mm

Medidas caja de comandos:
460×300×980mm

 **Características:**

Capacidade: 3.5T
Sistema de Controlo: Eléctrico Hidráulico
Comprimento plataforma: 4000mm
Comprimento plataforma secundária: 1600-1930mm
Largura plataforma principal: 610mm
Largura plataforma secundária: 550mm
Tempo elevação plataforma principal: 50s
Tempo descida plataforma principal: 60s
Tempo elevação plataforma secundária: 20s
Tempo descida plataforma secundária: 30s
Óleo hidráulico: 20L
Temperatura: 5-40°C
Humidade trabalho: 30-95%
Ruído: ≤ 76 db
Local instalação: Interior

 **Características:**

Capacidad: 3.5T
Sistema de control: Eléctrico hidráulico
Longitud de la plataforma principal: 4000 mm
Longitud de la plataforma secundaria: 1600-1930mm
Ancho de la plataforma principal: 610 mm
Ancho de la plataforma secundaria: 550 mm
Tiempo de elevación de la plataforma principal: 50s
Tiempo de descenso de la plataforma principal: 60s
Tiempo de elevación de la plataforma secundaria: 20s
Tiempo de descenso de la plataforma secundaria: 30s
Aceite hidráulico: aceite hidráulico 20L
Temperatura: 5-40°C
Humedad de trabajo: 30-95%
Ruido: ≤ 76 db
Lugar de instalación: Interior

REF

9824



2178kg



1x

-  Elevador dupla tesoura baixo perfil para alinhamento com LED 5,5T
 Elevador doble tijera bajo perfil para alineamiento con LED 5,5T

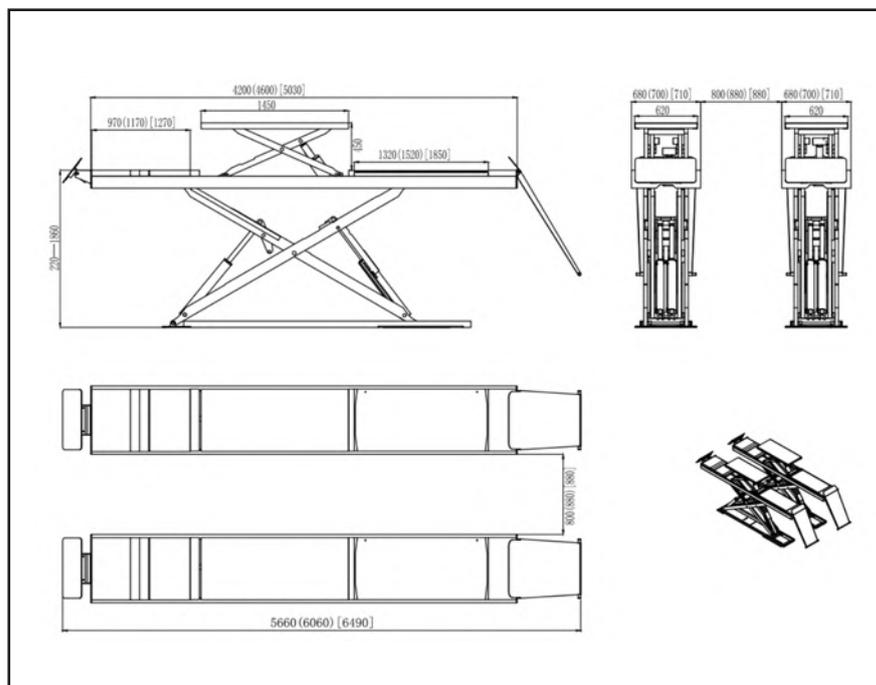

Nota: Em caso de atualização do modelo do elevador, consultar as medidas no site KROFtools

Nota: En caso de actualización del modelo del elevador, consultar las medidas en el sitio web de KROFtools

Medidas caixa comandos:
460×300×980mm

Medidas caja de comandos:
460×300×980mm



Características:

Capacidade: 5,5T
 Sistema de Controlo: Eléctrico Hidráulico
 Altura plataforma principal: 1860mm
 Altura plataforma secundária: 450mm
 Altura inicial plataforma: 220mm
 Comprimento plataforma principal: 5030mm
 Tempo subida plataforma principal: 50s
 Tempo descida plataforma principal: 60s
 Tempo subida plataforma secundária: 20s
 Tempo descida plataforma secundária: 30s
 Comprimento Total: 6490mm
 Óleo hidráulico: 20L (abrasivo)
 Pressão ar: 6~8 kg/cm²
 Temperatura trabalho: 5~40°C
 Humidade trabalho: 30~95%
 Ruído: ≤ 76 db
 Local instalação: Interior



Características:

Capacidad: 5.5T
 Sistema de control: Eléctrico hidráulico
 Altura de la plataforma principal: 1860mm
 Altura de plataforma secundaria: 450mm
 Altura inicial de la plataforma: 220mm
 Longitud plataforma principal: 5030mm
 Tiempo de subida de la plataforma principal: 50s
 Tiempo de descenso de la plataforma principal: 60s
 Tiempo de subida de plataforma secundaria: 20s
 Tiempo de descenso de la plataforma secundaria: 30s
 Longitud total: 6490mm
 Aceite hidráulico: aceite hidráulico abrasivo 20L
 Presión de aire: 6~8 kg/cm²
 Temperatura: 5~40°C
 Humedad: 30~95%
 Ruido: ≤ 76 db
 Lugar de instalación: Interior

REF

9823



2984kg



1x

-  Elevador dupla tesoura baixo perfil para alinhamento com LED 3,5T
-  Elevador doble tijera bajo perfil para alineamiento con LED 3,5T



 **Nota:** Em caso de atualização do modelo do elevador, consultar as medidas no site KROFtools

 **Nota:** En caso de actualización del modelo del elevador, consultar las medidas en el sitio web de KROFtools

Medidas caixa comandos:
460×300×980mm

Medidas caja de comandos:
460×300×980mm

 **Características:**

Capacidade Elevação: 3.5T
Sistema de controlo: Eléctrico Hidráulico
Altura plataforma principal: 1860mm
Altura plataforma secundária: 450mm
Altura plataforma inicial: 220mm
Comprimento total: 5660mm
Tempo subida plataforma principal: 50s
Tempo descida plataforma principal: 60s
Tempo subida plataforma secundária: 20s
Tempo descida plataforma secundária: 30s
Óleo hidráulico: 20# 20L
Temperatura trabalho: 5-40°C
Humidade trabalho: 30-95%
Ruído: ≤ 76 db
Local instalação: Interior

 **Características:**

Capacidad: 3.5T
Sistema de control: Eléctrico hidráulico
Altura de la plataforma principal: 1860mm
Altura de plataforma secundaria: 450mm
Altura inicial de la plataforma: 220mm
Longitud total: 5660mm
Tiempo de ascenso a la plataforma principal: 50s
Tiempo de descenso de la plataforma principal: 60s
Tiempo de subida de plataforma secundaria: 20s
Tiempo de descenso de la plataforma secundaria: 30s
Aceite hidráulico: aceite hidráulico 20L
Temperatura: 5-40°C
Humedad de trabajo: 30-95%
Ruido: ≤ 76 db
Lugar de instalación: Interior

REF

9832



2830kg



1x

 Elevador tesoura baixo perfil p/ alinhamento c/ led 4,5t

 Elevador bajo perfil tijera alineamento c/ led 4,5t

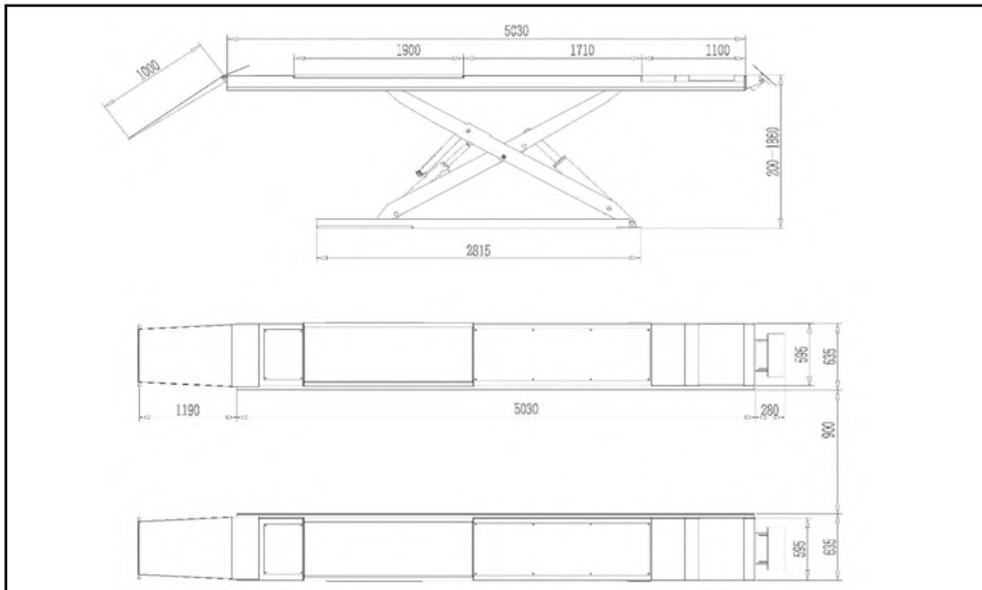

 **Nota:** Em caso de atualização do modelo do elevador, consultar as medidas no site KROFtools

 **Nota:** En caso de actualización del modelo del elevador, consultar las medidas en el sitio web de KROFtools

 **Características:**

Capacidade: 4.5T
 Funcionamento: Eletro-hidráulico
 Altura elevação: 1860mm
 Altura inicial plataformas: 200mm
 Comprimento plataformas: 5030mm
 Largura plataformas: 635mm
 Tempo de elevação: 50sg
 Tempo descida: 60sg
 Largura total: 2220mm
 Comprimento total: 6320mm
 Óleo hidráulico: 20L Hydraulic oil
 Temperatura: 5-40°C
 Humidade trabalho: 30-95%
 Ruído: ≤ 76 db
 Local instalação: Interior

 **Características:**

Capacidad: 4.5T
 Funcionamiento: Eléctrico Hidráulico
 Altura de elevación: 1860mm
 Altura inicial de la plataforma: 200mm
 Longitud de la plataforma: 5030mm
 Ancho de la plataforma: 635mm
 Tiempo de elevación: 50sg
 Tiempo de descenso: 60sg
 Anchura total: 2220mm
 Longitud total: 6320mm
 Aceite hidráulico: 20L Aceite hidráulico
 Temperatura: 5-40°C
 Humedad de trabajo: 30-95
 Ruido: ≤ 76 db
 Lugar de instalación: Interior

REF

9833



2494kg



1x

 Par extensões para suv - elevadores tesoura
 Extensión kit suv - elevadores de tijera



 **Descrição:**
Par de extensões para elevação de veículos com grandes distâncias entre os pontos de fixação na direção longitudinal

Conteúdo:
(2x) Extensões
(4x) Aumentos grandes: 150mm
(4x) Aumentos pequenos: 75mm

Dimensões:
Altura com aumentos grandes: 220mm
Altura com aumentos pequenos: 145mm
Altura com os dois aumentos: 295mm
Distância máxima entre o ponto médio de apoio: 1230mm

 **Descripción:**
Par de extensiones para el levantamiento de vehículos con grandes distancias entre los puntos de fijación en la dirección longitudinal

Contenido:
(2x) Extensiones
(4x) Ampliaciones grandes: 150mm
(4x) Ampliaciones pequeñas: 75mm

Dimensiones:
Altura con ampliaciones grandes: 220mm
Altura con ampliaciones pequeñas: 145mm
Altura con ambas ampliaciones: 295mm
Distancia máxima entre puntos medios de apoyo: 1230mm

REF

9816



20kg



1x

 Rampa borracha 1000x500mm
 Rampa de goma 1000x500mm



 **Descrição:**
Rampa de borracha para elevadores de tesoura

Características:
Sistema de produção: Moldagem por compressão
Material: Granulado de borracha
Peso: 21Kg
Dureza: 65/70 Shore A
Carga de rotura: 3 N/mm²
Alongamento na rotura: 120%
Resistência ao rasgamento: 5 N/mm²
Densidade: 1,2 g/cm³

 **Descripción:**
Rampa de goma para elevadores de tijera

Características:
Sistema de producción: Moldeo por compresión
Material: Granulado de caucho
Peso: 21 kg
Dureza: 65/70 Shore A
Carga de rotura: 3 N/mm²
Elongación en la rotura: 120%
Resistencia al desgarro: 5 N/mm²
Densidad: 1,2 g/cm³

REF

9797



21,2kg



50x

-  Rampa 300x261x49mm para kit alinhamento
 Rampa 300x261x49mm para kit alineacion



-  **Medidas:** 300x261x49mm
Aplicação: Para elevadores de plataformas lisas
Nota: O artigo Ref: 9857 utiliza-se em conjunto com o artigo Ref: 9858

-  **Medidas:** 300x261x49mm
Aplicación: Para elevadores de plataformas lisas
Nota: El artículo Ref: 9857 se utiliza junto con el artículo Ref: 9858

REF



9857

7kg

1x

-  Prato 500x261x50mm para alinhamento
 Plato 500x261x50mm para alineacion



-  **Medidas:** 500x261x50mm
Aplicação: Para elevadores de plataformas lisas
Nota: O artigo Ref: 9858 usa-se em conjunto com o artigo Ref: 9857

-  **Medidas:** 500x261x50mm
Aplicación: Para elevadores de plataformas lisas
Nota: El artículo Ref: 9858 se utiliza junto con el artículo Ref: 9857

REF



9858

30kg

2x

-  Plataforma 1200x400x50mm para alinhamento
 Plataforma 1200x400x50mm para alineacion



-  **Medidas:** 1200x400x50mm
Aplicação: Para elevadores de plataformas lisas
Nota: Este artigo pode ser usado em conjunto com o artigo Ref: 9857 e 9858

-  **Medidas:** 1200x400x50mm
Aplicación: Para elevadores de plataformas lisas.
Nota: Este artículo puede utilizarse junto con los artículos Ref: 9857 y 9858

REF



9859

41kg

1x

ROUPA DE TRABALHO

ROPA DE TRABAJO

RT



KROFtools[®]
PROFESSIONAL TOOLS

 FAMÍLIA	PÁGINAS
01 FERRAMENTA MANUAL	11-106
02 ALICATES	109-120
03 BITS E CONJUNTOS	123-134
04 FERRAMENTA ESPECÍFICA	137-214
05 FERRAMENTA CARROÇARIA	217-222
06 REGULAÇÃO E TESTE	225-246
07 FERRAMENTA MOTOR	249-276
08 KITS SINCRONIZAÇÃO	279-350
09 FERRAMENTA ELÉTRICA	353-362
10 FERRAMENTA PNEUMÁTICA	365-378
11 FERRAMENTA HIDRÁULICA	381-404
12 FERRAMENTA LUBRIFICAÇÃO	407-414
13 EQUIPAMENTO GARAGEM	417-502
RT ROUPA DE TRABALHO	505-508
MR MERCHANDISING	511-514
EP EXPOSITORES	517-524
LR LOCALIZAÇÃO REFERÊNCIAS	527-538

 FAMILIA	PÁGINAS
01 HERRAMIENTA MANUAL	11-106
02 ALICATES	109-120
03 PUNTAS Y CONJUNTOS	123-134
04 HERRAMIENTA ESPECÍFICA	137-214
05 HERRAMIENTA DE CARROCERIA	217-222
06 REGULACIÓN Y PRUEBAS	225-246
07 HERRAMIENTA PARA MOTOR	249-276
08 KIT CALADO	279-350
09 HERRAMIENTA ELÉCTRICA	353-362
10 HERRAMIENTA NEUMÁTICA	365-378
11 HERRAMIENTA HIDRÁULICA	381-404
12 HERRAMIENTA LUBRICACIÓN	407-414
13 EQUIPAMENTO PARA TALLER	417-502
RT ROPA DE TRABAJO	505-508
MR MERCHANDISING	511-514
EP EXPOSITORES	517-524
LR LOCALIZACIÓN REFERENCIAS	527-538



 Casaco KROFtools
 Chaqueta polar KROFtools



 **Descrição:**
Casaco acolchoado preto com fecho e logótipo
Medidas:
S, M, L, XL

 **Descripción:**
Chaqueta negra acolchada con cremallera y logotipo
Tallas:
S, M, L, XL

REF



CASACO

592gr



100x

 Colete KROFtools
 Chaleco KROFtools



 **Descrição:**
Colete impermeável 100% Nylon
Medidas:
S, M, L, XL

 **Descripción:**
Chaleco impermeable 100% nailon
Tallas:
S, M, L, XL

REF



COLETE

200gr



1x

 Polo KROFtools
 Polo KROFtools



 **Medidas:**
S, M, L, XL

 **Tallas:**
S, M, L, XL

REF



POLO

228gr



1x

 Sweatshirt manga comprida c/fecho
 Sudadera manga larga con cremallera



 **Descrição:**
Sweatshirt de manga comprida com 65% de algodão e 35% de poliéster. Tem malha cardada e logótipo bordado
Medidas:
M, L, XL, 2XL

 **Descripción:**
Sudadera de manga larga confeccionada en 65% algodón y 35% poliéster. Presenta un tejido de punto cardado y un logotipo bordado
Tallas:
M, L, XL, 2XL

REF



SWEATSHIRT

536gr



25x

-  Camisola t-shirt
 Camiseta de manga corta



 **Descrição:**
 T-shirt de gola redonda de algodão 180G com logótipo bordado
Medidas:
 S, M, L, XL, 2XL

 **Descripción:**
 T-shirt de cuello redondo de algodón 180G con logotipo bordado
Tallas:
 S, M, L, XL, 2XL

REF

T-SHIRT



204gr



50x

-  Camisola t-shirt manga comprida
 Camiseta de manga larga



 **Descrição:**
 T-shirt de manga comprida com gola redonda, de algodão 180G e logótipo bordado
Medidas:
 S, M, L, XL, 2XL

 **Descripción:**
 Camiseta de manga larga con cuello redondo, confeccionada en algodón 180G con logotipo bordado
Tallas:
 S, M, L, XL, 2XL

REF

T-SHIRT-MC



204gr



50x

-  Boné KROFtools
 Gorra KROFtools



REF

BONE



95gr



100x

-  Luvas trabalho mecânica KROFtools EN388 CE CAT II
 Guantes trabajo mecanica KROFtools EN388 CE CAT II



 Luvas de trabalho certificadas CAT II
Tamanho: 7, 8, 9, 10

 Guantes de trabajo certificadas CAT II
Talla: 7, 8, 9, 10

REF

LUVAS



80gr



100x

 Luvas de nitrilo pretas diamond 7.0 MIL x 100 PCS
 Guantes nitrilo negras diamond 7.0 MIL x 100 PZS



 Normas de Qualidade e Certificação: EN374, EN1186

Características:

Sem látex, livre de alergias
 Durável e fácil de usar
 Excelente sensibilidade
 Excelente resistência aos cortes e à abrasão
 Excelente resistência ao óleo

 Normas de Calidad y Certificaciones: EN374, EN1186

Características:

Sin látex, sin alergias
 Durable y fácil de usar
 Excelente sensibilidade
 Excelente resistencia al corte y a la abrasión
 Excelente resistencia al aceite

REF	Tamanho/Talla		
6001	M	700gr	10x
6002	L	780gr	10x
6003	XL	830gr	10x

 Luvas de nitrilo laranja diamond 7.0mil x 100 PCS

 Guantes nitrilo naranja diamond 7.0mil x 100 PZS



 Normas de Qualidade e Certificação: EN374, EN1186

Características:

Sem látex, livre de alergias
 Durável e fácil de usar
 Excelente sensibilidade
 Excelente resistência aos cortes e à abrasão
 Excelente resistência ao óleo

 Normas de Calidad y Certificaciones: EN374, EN1186

Características:

Sin látex, sin alergias
 Durable y fácil de usar
 Excelente sensibilidad
 Excelente resistencia al corte y a la abrasión
 Excelente resistencia al aceite

REF	Tamanho/Talla		
6004	M	700gr	10x
6005	L	780gr	10x
6006	XL	830gr	10x

**MERCHANDISING
MERCHANDISING**

MR



KROFtools[®]
PROFESSIONAL TOOLS

 FAMÍLIA	PÁGINAS
01 FERRAMENTA MANUAL	11-106
02 ALICATES	109-120
03 BITS E CONJUNTOS	123-134
04 FERRAMENTA ESPECÍFICA	137-214
05 FERRAMENTA CARROÇARIA	217-222
06 REGULAÇÃO E TESTE	225-246
07 FERRAMENTA MOTOR	249-276
08 KITS SINCRONIZAÇÃO	279-350
09 FERRAMENTA ELÉTRICA	353-362
10 FERRAMENTA PNEUMÁTICA	365-378
11 FERRAMENTA HIDRÁULICA	381-404
12 FERRAMENTA LUBRIFICAÇÃO	407-414
13 EQUIPAMENTO GARAGEM	417-502
RT ROUPA DE TRABALHO	505-508
MR MERCHANDISING	511-514
EP EXPOSITORES	517-524
LR LOCALIZAÇÃO REFERÊNCIAS	527-538

 FAMILIA	PÁGINAS
01 HERRAMIENTA MANUAL	11-106
02 ALICATES	109-120
03 PUNTAS Y CONJUNTOS	123-134
04 HERRAMIENTA ESPECÍFICA	137-214
05 HERRAMIENTA DE CARROCERIA	217-222
06 REGULACIÓN Y PRUEBAS	225-246
07 HERRAMIENTA PARA MOTOR	249-276
08 KIT CALADO	279-350
09 HERRAMIENTA ELÉCTRICA	353-362
10 HERRAMIENTA NEUMÁTICA	365-378
11 HERRAMIENTA HIDRÁULICA	381-404
12 HERRAMIENTA LUBRICACIÓN	407-414
13 EQUIPAMENTO PARA TALLER	417-502
RT ROPA DE TRABAJO	505-508
MR MERCHANDISING	511-514
EP EXPOSITORES	517-524
LR LOCALIZACIÓN REFERENCIAS	527-538



WWW.KROFTOOLS.COM



KROFTOOLS

 Cadeira de escritório KROFtools
 Silla de oficina KROFtools



REF
ROCK

18,2gr

1x

 Protetor sol KROFtools
 Parasol KROFtools



REF
PROTETOR-SOL

160gr

1x

 Guarda chuva KROFtools
 Paraguas KROFtools



REF
GUARDA-CHUVA

470gr

1x

 Garrafa KROFtools
 Botella KROFtools



REF		
GARRAFA	105gr	100x

 Pen USB 4GB KROFtools
 Pen USB 4GB KROFtools



REF		
PEN	73gr	1x

 Porta-chaves KROFtools
 Porta llaves KROFtools



REF		
PORTA-CHAVES	10gr	1x

 Notebook KROFtools
 Notebook KROFtools



REF		
NOTEBOOK	328gr	1x

 Alicates multifunções 9 em 1
 Tenaza multi-herramientas 9 en 1



REF		
MULTITOOL	270gr	50x

Trotinete eléctrica KROftools
Patinete eléctrica KROftools



Características:

Carga máxima (kg): 120
Peso da trotinete (kg): Cerca de 16
Altura adequada (cm): 130-200
Velocidade (km/h): 25Km/h
Alcance (km): 20km (depende da capacidade da bateria)
Capacidade de subida: ≤15°
Grau de impermeabilidade: IPX4

Bateria:

Tensão nominal (V): 48
Tensão de entrada de carregamento (V): 54.6
Capacidade da bateria (AH): 6
BMS inteligente: Proteção contra sobreaquecimento, sobrecarga e subtensão
Tempo de carregamento (h): 3

Características:

Carga máxima (kg): 120
Peso del scooter (kg): Alrededor del 16
Altura adecuada (cm): 130-200
Velocidad (km/h): 25Km/h
Llegue a (km): 20km (depende de la capacidad de la batería)
Capacidad de escalada: ≤15°
Grado de impermeabilidad: IPX4

Batería:

Tensión nominal (V): 48
Tensión de entrada de carga (V): 54.6
Capacidad de la batería (AH): 6
BMS inteligente: Protección contra sobrecalentamiento, sobrecarga y subtensión
Tiempo de carga (h): 3

REF

TROTINETE



16,5kg



1x

Trolley viagem KROftools
Maleta KROftools



Características:

Mala de viagem
Etiqueta com o logótipo em preto
Tamanho: 420x250x350mm com pega telescópica de 3 segmentos
Material: 1680D
Rodas sólidas
Fecho de metal

Características:

Maleta de viaje
Etiqueta com logo en color negro
Tamaño: 420x250x350mm con asa telescópica de 3 secciones
Material: 1680D
Ruedas sólidas
Cremallera de metal

REF

BAGKR



3,4kg



1x

Base bandeira 6kg c/ pino
Base plana 6kg con pasador



Tamanho:

35x35cm

Tamaño:

35x35cm

REF

FLAGB



5,6kg



2x

 Bandeira 3.3m - Wing format

 Bandera 3.3m - Wing format



 **Características:**
 Material: 100% fibra de poliéster, 110gr/m²
 Altura do mastro da bandeira: 3.3M
 Tamanho da bandeira: 60x240cm

 **Características:**
 Material: 100% fibra de poliéster, 110gr/m²
 Altura del mástil de la bandera: 3.3M
 Tamaño de la bandera: 60x240cm

REF

FLAG33



1,55kg



10x

 Bandeira 4.5m - Wing format

 Bandera 4.5m - Wing format



 **Características:**
 Material: 100% fibra de poliéster, 110gr/m²
 Altura do mastro da bandeira: 4.5M
 Tamanho da bandeira: 70x320cm

 **Características:**
 Material: 100% fibra de poliéster, 110gr/m²
 Altura del mástil de la bandera: 4.5M
 Tamaño de la bandera: 70x320cm

REF

FLAG45



1,96kg



10x

 Tenda XA 3x3m

 Tienda XA 3x3m



 **Dimensões:**
 Altura mínima: 2020mm
 Altura máxima: 2300mm
 A altura central ao solo é ajustável: 2800mm a 3080mm

 **Dimensiones:**
 Altura mínima: 2020mm
 Altura máxima: 2300mm
 Altura central al suelo ajustable: 2800mm a 3080mm

REF

TENT33



13kg



1x

 Tenda XA 3x6m

 Tienda XA 3x6m



 **Dimensões:**
 Altura mínima: 2020mm
 Altura máxima: 2300mm
 A altura central ao solo é ajustável: 2800mm a 3080mm

 **Dimensiones:**
 Altura mínima: 2020mm
 Altura máxima: 2300mm
 Altura central al suelo ajustable: 2800mm a 3080mm

REF

TENT36



29kg



1x

EXPOSITORES
EXPOSITORES

EP



KROFtools[®]
PROFESSIONAL TOOLS

 FAMÍLIA	PÁGINAS
01 FERRAMENTA MANUAL	11-106
02 ALICATES	109-120
03 BITS E CONJUNTOS	123-134
04 FERRAMENTA ESPECÍFICA	137-214
05 FERRAMENTA CARROÇARIA	217-222
06 REGULAÇÃO E TESTE	225-246
07 FERRAMENTA MOTOR	249-276
08 KITS SINCRONIZAÇÃO	279-350
09 FERRAMENTA ELÉTRICA	353-362
10 FERRAMENTA PNEUMÁTICA	365-378
11 FERRAMENTA HIDRÁULICA	381-404
12 FERRAMENTA LUBRIFICAÇÃO	407-414
13 EQUIPAMENTO GARAGEM	417-502
RT ROUPA DE TRABALHO	505-508
MR MERCHANDISING	511-514
EP EXPOSITORES	517-524
LR LOCALIZAÇÃO REFERÊNCIAS	527-538

 FAMILIA	PÁGINAS
01 HERRAMIENTA MANUAL	11-106
02 ALICATES	109-120
03 PUNTAS Y CONJUNTOS	123-134
04 HERRAMIENTA ESPECÍFICA	137-214
05 HERRAMIENTA DE CARROCERIA	217-222
06 REGULACIÓN Y PRUEBAS	225-246
07 HERRAMIENTA PARA MOTOR	249-276
08 KIT CALADO	279-350
09 HERRAMIENTA ELÉCTRICA	353-362
10 HERRAMIENTA NEUMÁTICA	365-378
11 HERRAMIENTA HIDRÁULICA	381-404
12 HERRAMIENTA LUBRICACIÓN	407-414
13 EQUIPAMENTO PARA TALLER	417-502
RT ROPA DE TRABAJO	505-508
MR MERCHANDISING	511-514
EP EXPOSITORES	517-524
LR LOCALIZACIÓN REFERENCIAS	527-538



-  Expositor 3 neumáticas 300X140X340mm
-  Display 3 neumáticas 300X140X340mm

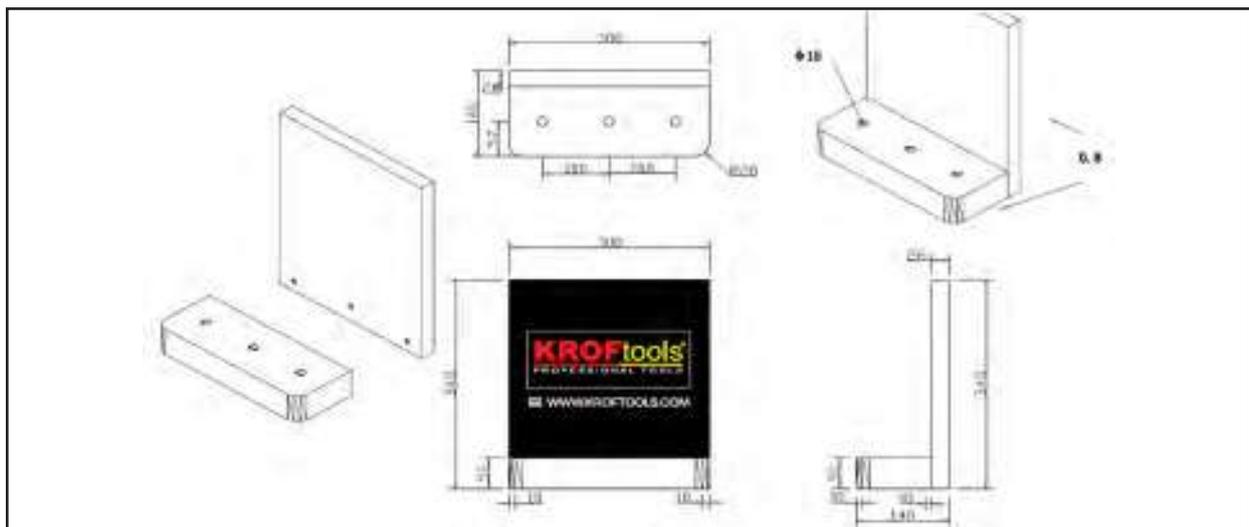

① NOTA: Recomendado con pneumáticas de 1/2"
 NOTA: Recomendado con pneumática de 1/2"

REF
DISP13

2kg

1x

 Expositor luminoso 2M

 Expositor luminoso herramientas 2M

 **Dimensões gerais:**

1000x450x2200mm

Composição:Expositor com (2x) prateleiras 965x350mm;
(50x) ganchos 100mm
 **Dimensiones generales:**

1000x450x2200mm

Composición:Expositor con (2x) estantes 965x350mm;
(50x) ganchos 100mm

REF

8595



8kg



1x

- Expositor chaves de caixa 330x255x300mm
- Display llaves de vaso 330x255x300mm

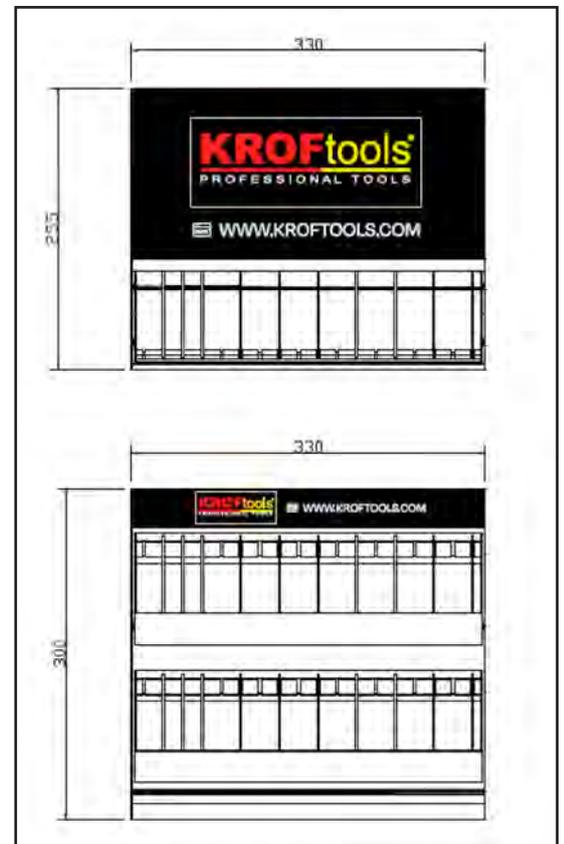

REF
DISP9

6,5kg

1x

Expositor 54 chaves punho 350x310mm
Display 54 destornilladores 350x310mm

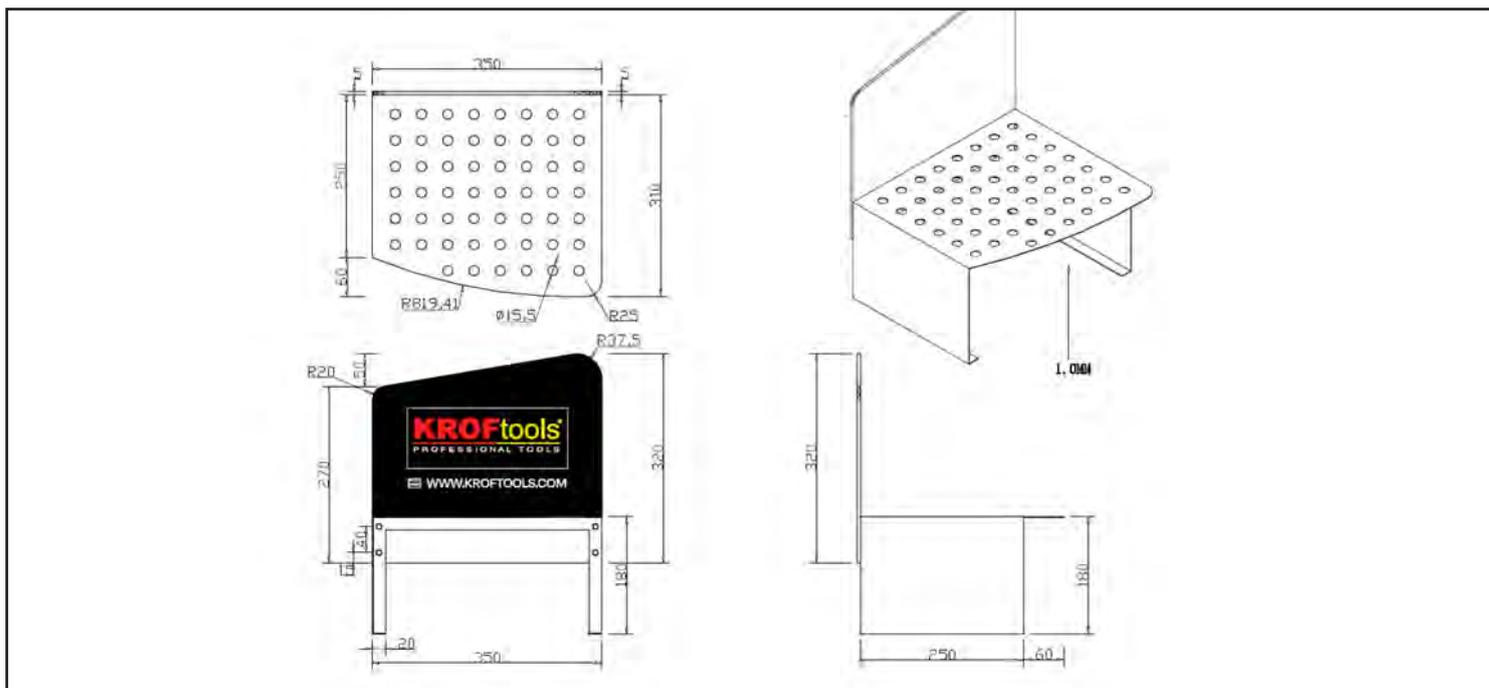

REF
DISP8

2,5kg

1x

-  Prateleira 9 pneumáticas 933X280MM
-  Estante 9 neumáticas 933X280MM

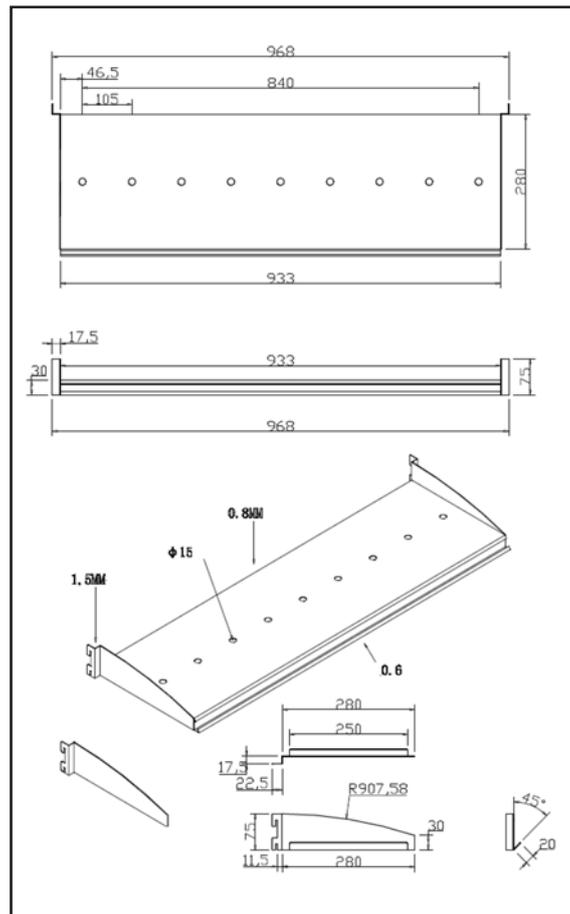
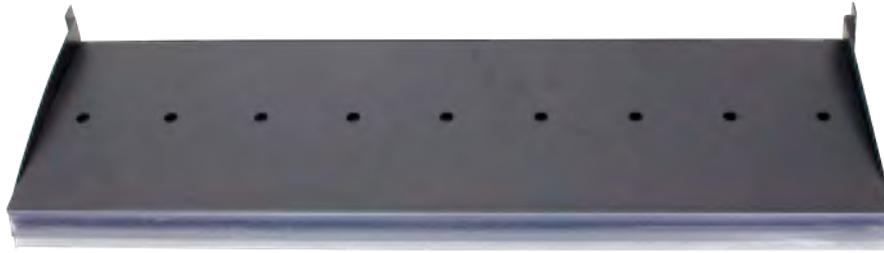

REF

DISP12



3kg



1x

-  Expositor triangular móvil 456x1800mm
-  Display triangular móvil 456x1800mm

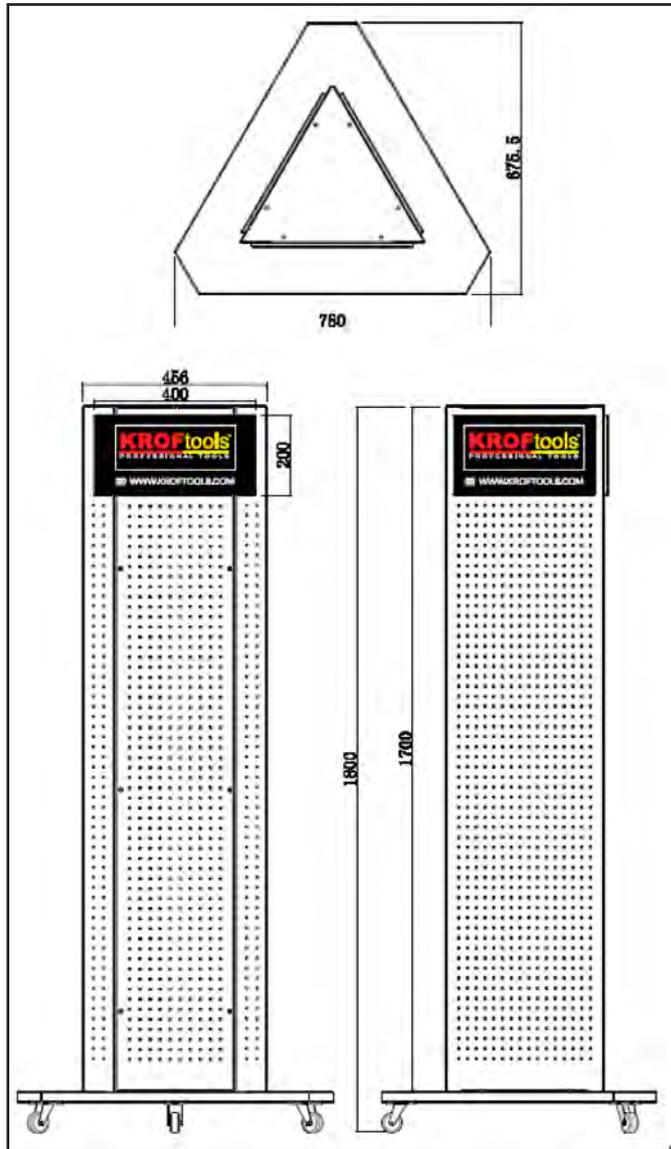

REF
DISP10

6,9kg

1x

-  Gancho p/ pneumática 104mm
-  Gancho neumática 104mm

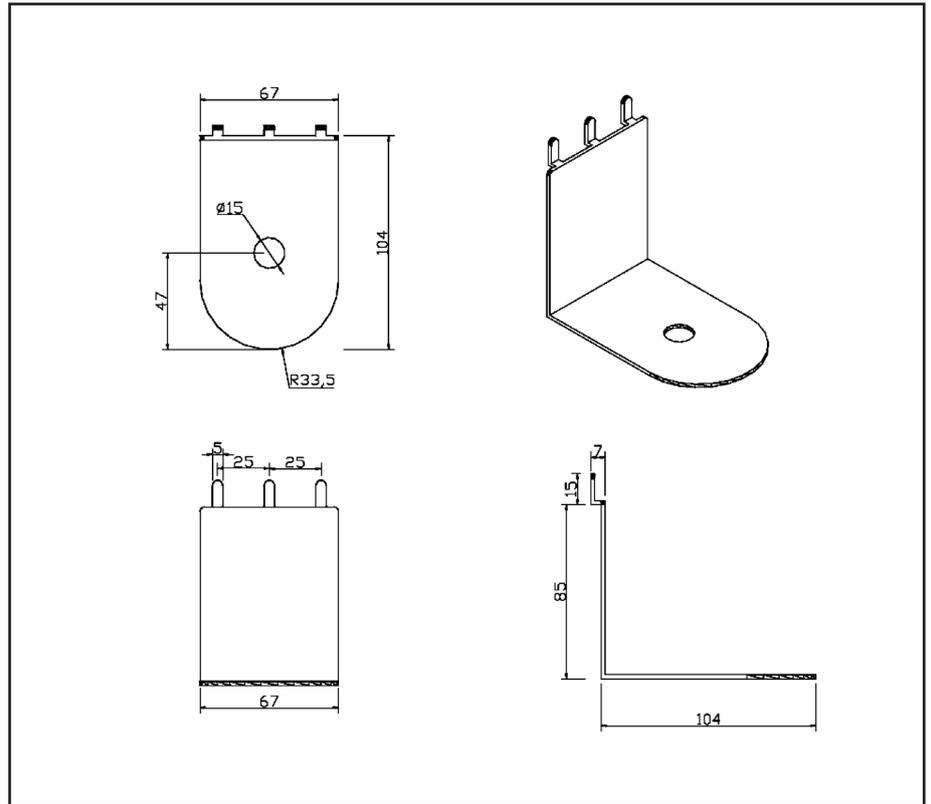

REF		
DISP11	200gr	1x

-  Suporte magnético p/ máquinas pneumáticas 15kg
-  Colgador imantador p/ ferramenta neumatica - 15kg



-  **Características:**
- Suporta:
- Chaves de impacto pneumáticas
- Chaves para porcas das rodas
- Chaves dinamométricas
- Ímanes fortes
- Capacidade: 15kg

-  **Características:**
- Suporta:
- Chaves de impacto pneumáticas
- Chaves para porcas das rodas
- Chaves dinamométricas
- Ímanes fortes
- Capacidade: 15kg

REF		
9241	1,5kg	10x

Display p/ chaves fenda
Display para destornilladores



Dimensões: Largura: 215mm, comprimento: 460mm

Dimensiones: Ancho: 215mm, longitud: 460mm

REF		
DISP5	2kg	1x

Display para chaves de caixa
Display para llaves de vaso



Dimensões: Largura: 250mm, comprimento: 967mm

Dimensiones: Ancho: 250mm, longitud: 967mm

REF		
DISP6	3kg	1x

Display para chaves de caixa
Display para llaves de vaso



Dimensões: Largura: 250mm, comprimento: 450mm

Dimensiones: Ancho: 250mm, longitud: 450mm

REF		
DISP7	3kg	1x

Gancho 100mm
Gancho 100mm



Dimensões: Comprimento: 100mm

Dimensiones: Longitud: 100mm

REF		
DISP3	25gr	100x

LOCALIZAÇÃO REFERÊNCIAS
LOCALIZACIÓN REFERENCIAS

LR



KROFtools[®]
PROFESSIONAL TOOLS

 FAMÍLIA	PÁGINAS
01 FERRAMENTA MANUAL	11-106
02 ALICATES	109-120
03 BITS E CONJUNTOS	123-134
04 FERRAMENTA ESPECÍFICA	137-214
05 FERRAMENTA CARROÇARIA	217-222
06 REGULAÇÃO E TESTE	225-246
07 FERRAMENTA MOTOR	249-276
08 KITS SINCRONIZAÇÃO	279-350
09 FERRAMENTA ELÉTRICA	353-362
10 FERRAMENTA PNEUMÁTICA	365-378
11 FERRAMENTA HIDRÁULICA	381-404
12 FERRAMENTA LUBRIFICAÇÃO	407-414
13 EQUIPAMENTO GARAGEM	417-502
RT ROUPA DE TRABALHO	505-508
MR MERCHANDISING	511-514
EP EXPOSITORES	517-524
LR LOCALIZAÇÃO REFERÊNCIAS	527-538

 FAMILIA	PÁGINAS
01 HERRAMIENTA MANUAL	11-106
02 ALICATES	109-120
03 PUNTAS Y CONJUNTOS	123-134
04 HERRAMIENTA ESPECÍFICA	137-214
05 HERRAMIENTA DE CARROCERIA	217-222
06 REGULACIÓN Y PRUEBAS	225-246
07 HERRAMIENTA PARA MOTOR	249-276
08 KIT CALADO	279-350
09 HERRAMIENTA ELÉCTRICA	353-362
10 HERRAMIENTA NEUMÁTICA	365-378
11 HERRAMIENTA HIDRÁULICA	381-404
12 HERRAMIENTA LUBRICACIÓN	407-414
13 EQUIPAMENTO PARA TALLER	417-502
RT ROPA DE TRABAJO	505-508
MR MERCHANDISING	511-514
EP EXPOSITORES	517-524
LR LOCALIZACIÓN REFERENCIAS	527-538



Referência	Páginas	Referência	Páginas	Referência	Páginas	Referência	Páginas
Referencia	Páginas	Referencia	Páginas	Referencia	Páginas	Referencia	Páginas
0013	137	1110NA	89	1226	56	1510	281, 324
0014	137	1110NP	89	1226L	57	1511	283, 298, 305, 326, 348
0111	116	1111	88	1227	56	1512	301
0220	110	1115	117	1227L	57	1513	319, 325
0225	219	1130	72	1228	56	1514	332
0512	173	1131	70	1228L	57	1515	330
0512-2	173	1132	69	1229	56	1516	299
0512-3	173	1133	71	1229L	57	1517	333
0512-5	173	1134	72	1230	56	1518	302
0512-7	173	1150	354	1230L	57	1519	319
0512-8	173	1151	355	1232	56	1520	281, 299, 350
0512-10	173	1152	355	1232L	57	1521	301
0515	173	1153	360	1233	62	1522	313
0516	173	1154	354	1234	62	1523	298, 302, 346
0517	173	1155	357	1235	63	1524	332
0810	267	1156	360	1236	63	1525	325
0811	268	1185	97	1237	63	1526	282
0812	268	1210	56	1238	63	1527	286
1026	252	1210E	56	1239	128	1528	287
1027	252	1210EL	56	1285	276	1529	331
1028	252	1210L	56	1290	276	1530	287
1029	252	1211	56	1295	87	1531	333
1030	252	1211E	56	1300	90	1532	282, 325
1031	252	1211EL	56	1301	90	1533	314
1032	88	1211L	56	1305	90	1534	287, 311
1033	88	1212	56	1310	90	1536	282
1040	266	1212E	56	1315	90	1537	288
1040M13	266	1212EL	56	1320	90	1538	288, 312
1040M13X1.5	266	1212L	56	1325	90	1539	288, 311
1040M13X1.25	266	1213	56	1330	89	1541	334
1040M15	266	1213L	56	1335	89	1542	320, 326
1040M15X1.5	266	1214	56	1340	89	1543	288
1040M17	266	1214E	56	1350	276	1544	333
1040M17X1.5	266	1214EL	56	1380	196	1546	315
1040M20	266	1214L	57	1404E	54	1547	303
1040M20X1.5	266	1215	56	1405E	54	1548	289
1040M22	266	1215L	57	1406E	54	1549	314
1040M22X1.5	266	1216	56	1407E	54	1550	289
1041	268	1216E	56	1408	229	1551	321
1042	268	1216EL	56	1408B	229	1552	341
1043	267	1216L	57	1408E	54	1553	296, 299
1046	360	1217	56	1408M	229	1554	156
1052	361	1217L	57	1408T	229	1556	345
1054	361	1218	56	1409	229	1557	279
1057	357	1218E	56	1410E	54	1558	334
1062	358	1218EL	56	1411E	54	1559	313, 314
1068	359	1218L	57	1412	62	1560	283, 302
1070	357	1219	56	1414	61	1561	285
1074	359	1219L	57	1415	61	1562	284
1075	359	1220	56	1416	62	1563	322
1077	358	1220E	56	1417	62	1564	341
1078	358	1220EL	56	1418	63	1565	289
1079	358	1220L	57	1419	62	1566	285
1082	355	1221	56	1420	62	1567	327, 344
1083	356	1221L	57	1440	76	1568	335, 347
1084	356	1222	56	1445	149	1569	290
1086	360	1222E	56	1450	168	1570	279
1087	353	1222EL	56	1500	343	1571	335
1089	354	1222L	57	1501	287, 311	1572	289
1090	356	1223	56	1502	332	1573	284
1091	354	1223L	57	1503	324, 345	1574	303
1093	353	1224	56	1504	284	1575	334
1095	353	1224E	56	1505	298	1576	313
1096	359	1224EL	56	1506	230	1577	335
1097	353	1224L	57	1507	281	1578	321
1099	357	1225	56	1508	324	1579	328
1110	89	1225L	57	1509	323	1580	169

Referência	Páginas	Referência	Páginas	Referência	Páginas	Referência	Páginas
Referencia	Páginas	Referencia	Páginas	Referencia	Páginas	Referencia	Páginas
1581	271, 322	1653	291, 327	1718	301	2076	413, 419
1582	338	1654	305	1719	298	2077	417, 418
1583	148	1655	317	1721	306	2078	370
1584	169	1656	305	1722	320	2079	370
1585	169	1657	283, 306, 326, 348	1723	343	2080	418
1586	169	1657A	283, 306, 326, 348	1724	307	2081	377
1587	322, 328	1657B	283, 306, 326, 348	1725	350	2082	377
1588	322	1657F	283, 306, 326, 348	1726	286	2082-01	377
1589	169	1657S	283, 306, 326, 348	1727	286	2083	377
1590	167	1658	297, 311	1728	344	2084	418
1591	167	1659	292	1729	300	2084T	419
1593	167	1660	292	1730	342	2085	418
1594	167	1661	306	1731	342	2086	377
1595	167	1662	294	1732	343	2086-01	377
1596	168	1664	331	1733	280	2087	417
1597	194	1665	295, 297	1734	307	2088	417
1598	168	1666	293	1839	187	2089	370
1599	303	1667	330	1840	187	2090	376
1600	315	1668	292	1841	187	2092	376
1601	295	1669	347	1902M6	125	2093	377
1602	336	1670	293	1902M8	125	2094	374
1603	344	1671	337	1902S6	125	2096	375
1604	315	1672	338	1910	160	2096-01	375
1606	290	1673	338	1912	275	2096-02	375
1607	312, 349	1674	318	1914	159	2096-03	375
1609	313, 316	1675	293	1915	153	2096-04	375
1610	335	1676	307	1916	160	2096-05	375
1611	336	1677	294	1916P	160	2096-06	375
1612	280	1678	318	1917	152	2096-07	375
1613	280	1679	293	1917A1	152	2096-08	375
1614	316	1680	230	1917A2	152	2096-09	375
1615	304, 348	1681	317	1917A3	152	2096-10	375
1616	309	1682	230	1917A4	152	2097	376
1617	284	1683	347	1917A5	152	2098	375
1618	290	1684	285	1918	153	2099	375
1620	316, 321, 328	1685	230	1920	152	2100	126
1621	304	1686	230	1925	152	2101	61, 339
1622	329	1687	303	1935	187	2103	274
1623	329	1688	315	1941	174	2104	275
1625	331	1689	343	1944	173	2105	275
1626	336	1690	344	1950	174	2106	275
1627	155	1691	316	2001	131	2107	270
1628	155	1692	294	2004	166	2115	274
1629	312	1693	309	2005	166	2122	84
1630	187	1694	319, 320	2006	166	2123	84
1631	333	1695	324	2007	171	2124	84
1632	329	1696	295	2008	167	2125	18
1633	154	1697	337	2008-08	167	2126	77
1634	309	1698	308	2008-09	167	2146	137
1635	310	1699	337	2008-10	167	2150	273
1636	290	1700	330	2008-12	167	2152	274
1637	300, 305, 312, 345	1701	299, 330, 346	2008-14	167	2156	274
1638	310	1702	318, 320	2008-16	167	2218	83
1639	317	1703	309	2009	167	2226	87
1640	332	1704	296	2015	272	2237	66
1641	341	1705	307	2016	272	2299	376
1642	291	1706	281, 300, 323, 328	2018	272	2306	98
1643	291	1707	297, 325, 346	2021	272	2308	98
1644	291	1707-01	297, 325, 346	2035	81	2310	98
1645	286, 329, 345	1708	189	2044	139	2311	98
1646	300, 327	1709	296	2046	81	2312	98
1647	334	1710	314	2060	397	2313	98
1648	310	1711	310	2061	397	2314	98
1649	323	1712	342	2062	453	2315	98
1650	342	1713	296	2073	417	2317	98
1651	349	1714	317	2074	417	2319	98
1652	349	1716	347	2075	418	2320	98

Referência	Páginas	Referência	Páginas	Referência	Páginas	Referência	Páginas
Referencia	Páginas	Referencia	Páginas	Referencia	Páginas	Referencia	Páginas
2321	98	2898	341	3212T	262	3419	58
2322	98	2899	279	3214	262	3419L	58
2323	98	2985	115	3214T	262	3420	67
2324	98	2991	208	3230	262	3421	58
2331	137	2991A	208	3231	262	3421L	58
2333	138	2991B	208	3232	263	3422	58
2335	137	2991C	208	3233	263	3423	58
2336	137	2991D	208	3234	263	3423L	58
2337	267	2991E	208	3235	255	3424	58
2338	138	2991EP	208	3236	412	3424L	58
2339	138	2991F	208	3237	233	3426	58
2340	138	2991G	208	3238	413	3426L	58
2341	138	2991H	208	3250	254	3427	58
2342	138	2991I	208	3253	254	3427L	58
2355	128	2991J	208	3255	254	3428	58
2356	128	2991S	208	3278	255	3429	58
2370	128	2992	209	3279	254	3429L	58
2375	128	3020	104	3281	255	3430	58
2401	116	3021	105	3282	259	3432	58
2402	116	3022	106	3283	259	3433	58
2403	117	3049	233	3284	259	3433L	58
2404	117	3049M	233	3285	255	3434	58
2405	117	3050	228	3287	257	3435	58
2406	22	3051	87	3288	257	3435L	58
2406V	22	3052	130	3289	258	3436	58
2412	116	3053	129	3290	256	3436L	58
2413	112	3055	84	3291	256	3438	58
2414	116	3056	132	3293	261	3438L	58
2415	109	3057	132	3294	261	3441	58
2416	109	3058	133	3295	258	3441L	58
2416-1	109	3059	133	3296	260	3446	58
2417	217	3060	132	3297	256	3500	86
2418	109	3061	132	3298	259	3502	244
2419	109	3062	132	3299	260	3502-01	244
2420	220	3063	132	3300	262	3503	244
2421	221	3064	132	3301	254	3503-01	244
2425	220	3065	132	3301J5	254	3510	412
2430	220	3066	132	3301J10	254	3520	409
2490	221	3067	95	3301J20	254	3530	407
2491	221	3074	87	3306	140	3540	408
2492	221	3075	130	3306BIT	140	3550	407
2493	221	3076	130	3307	140	3560	407
2495	222	3078	129	3307A	140	3570	409
2500	240	3110	207	3309	142	3571	410
2501	194	3111	143	3310-T50	140	3572	414
2502	194	3112	144	3310-T50C	142	3573	414
2503	194	3113	144	3311	142	3574	410
2504	195	3114	129	3311H08	142	3575	410
2505	240	3114-M6	129	3311H10	142	3580	412
2507	193	3114-M7	129	3311M08	142	3581	411
2507TU	193	3114-M8	129	3311M10	142	3582	411
2508	193	3114-M9	129	3311T40	142	3583	412
2509	195	3114-M12	129	3311T50	142	3584	411
2510	195	3114-M14	129	3312	143	3585	411
2511	194	3115	146	3317	339	3586	411
2514	234	3116	146	3318	340	3600	86
2514B	234	3117	172	3319	340	3734	112
2515	233	3118	144	3320	339	3735	113
2516	234	3119	145	3321	340	3739	113
2517	235	3120	203	3322	350	3739-M03	113
2518	235	3121	145	3323	295	3739-M04	113
2550	241	3122	145	3350	133	3739-M05	113
2580	169	3123	170	3380	86	3739-M06	113
2585	149	3124	177	3400	86	3739-M08	113
2637	174	3125	146	3404	140	3739-M10	113
2809	177	3126	151	3417	58	3739-M12	113
2897	280, 297, 308	3212	262	3417L	58	3740	88

Referência	Páginas	Referência	Páginas	Referência	Páginas	Referência	Páginas
Referencia	Páginas	Referencia	Páginas	Referencia	Páginas	Referencia	Páginas
3803	100	4405-09	166	4710	390	4906	384
3804	100	4407	141	4712	391	4907	384
3805	105	4410	162	4716	391	4908	383
3808E	55	4410-01	162	4720	391	4915	387
3810E	55	4410-02	162	4730	392	4920	392
3811E	55	4410-03	162	4750	392	4926	382
3812E	55	4410-04	162	4753	422	4930	393
3814E	55	4410-05	162	4756	422	4932	385
3816E	55	4410-06	162	4757	425	4940	381
3818E	55	4410-07	162	4804	382	4942	383
3830	97	4410-08	162	4812	389	5018	231
3835	97	4410-09	162	4813	381	5018M	231
4012	64	4410-10	162	4814	385	5086	110
4014	64	4410-11	162	4816	387	5233	240
4038	64	4410-12	162	4817	388	5234	240
4050	65	4410-13	162	4818	388	5278	326
4087	251	4410-14	162	4820A23	395	5290	222
4088	249	4410-15	162	4820A24	395	5310	253
4100	65	4410-16	162	4820A25	395	5315	264
4120	66	4410-17	162	4820A28	395	5316	265
4122	66	4410-18	162	4820A30	395	5318	265
4123	64	4410-19	162	4820B30	395	5319	251
4125	67	4410-20	162	4820B33	395	5320	254
4145	65	4443	164	4821	396	5325	264
4163	177	4445	165	4822	386	5330	264
4164	178	4445-14	165	4823	386	5340	251
4179	218	4445BR7	165	4824	386	5341	251
4251	67	4445BR9	165	4825	394	5350	264
4252	67	4445D	165	4825B30	394	5379	222
4253	67	4445M8X1	165	4826	396	5380	219
4254	67	4445M10X1	165	4827	395	5390	218
4380	65	4445P9	165	4829	452	5391	218
4400	163	4446	165	4830	453	5392	218
4400-01	163	4447	164	4831	452	5396	219
4400-02	163	4450	164	4833	452	5400	219
4400-03	163	4450-1	164	4841	222	5401	218
4400-04	163	4450-2	164	4842	423	5405	85
4400-05	163	4450-3	164	4843	423	5406	85
4400-06	163	4450-4	164	4845	394	5408	218
4400-07	163	4451	87	4851	377	5409	217
4400-08	163	4460	212	4855	453	5410	252
4400-09	163	4461	212	4857	424	5415	253
4400-10	163	4462	212	4860	403	5420	253
4400-11	163	4463	212	4863	403	5430	253
4400-12	163	4464	212	4864	403	5440	249
4400-13	163	4465	212	4865	404	5450	214
4400-14	163	4466	212	4865R3	403, 404	5510	372
4400-15	163	4467	212	4865R35	404	5511	372
4400-16	163	4468	212	4867	404	5516	103
4400-17	163	4469	212	4868	404	5517	103
4400-18	163	4470	212	4873	425	5633	276
4400-19	163	4471	212	4873R	425	5720	217
4400-20	163	4482	231	4876	425	5776	125
4400-21	163	4483	240	4880	399	5917	192
4400-22	163	4484	231	4880E	401	5925	189
4400-23	163	4485	233	4881	402	5930	192
4401	245	4486	229	4882	402	5944	191
4402	161	4490	232	4885	400	5955	188
4403	196	4495	232	4885E	401	5956	191
4404	141	4496	232	4890E	402	5957	188
4405	166	4521	65	4891	397	5958	189
4405-01	166	4541	65	4892	398	5959	190
4405-02	166	4542	65	4897	401	5959FUDR	190
4405-03	166	4637	214	4897E	402	5959FUEQ	190
4405-04	166	4702	389	4898-01	398	5960	188
4405-05	166	4703	390	4898-02	399	5961	192
4405-08	166	4705	390	4899-01	398	5962	190

Referência	Páginas	Referência	Páginas	Referência	Páginas	Referência	Páginas
Referencia	Páginas	Referencia	Páginas	Referencia	Páginas	Referencia	Páginas
5965	192	6123	171	6160XM08L	124	6331	177
5966	189	6124	211	6160XM09L	124	6335	175
5970	213	6125	170	6160XM10L	124	6336	175
5980	193	6126	213	6160XM12L	124	6337	175
6001	507	6130	170	6160XM14L	124	6340	176
6002	507	6135	170	6160XM16HL	124	6341	186
6003	507	6136	169	6162	242	6342	176
6004	508	6137	217	6163	243	6345	175
6005	508	6138	273	6163P	243	6346	187
6006	508	6140	168	6164	242	6347	186
6026	79	6145	127	6165	243	6350	186
6030	79	6159	129	6165P	243	6355	207
6032	80	6160	127	6170	242	6362	200
6088	80	6160AD12	126	6178	117, 214	6366	200
6090	171	6160AD38	125	6180	110	6372	200
6091	171	6160CPH2	125	6185	112	6378	200
6093	133	6160F08	124	6186	111	6382	201
6094	134	6160H04	124	6187	111	6385	200
6094-13	134	6160H04L	124	6188	112	6390	201
6094-14	134	6160H05	124	6190	241	6410	234
6094-15	134	6160H05L	124	6246	253	6420	339
6094-16	134	6160H06	124	6250	111	6425	179
6094-17	134	6160H06L	124	6255	139	6430	196
6094-21	134	6160H07	124	6256	111	6434	198
6094-22	134	6160H07L	124	6257	111	6435	197
6094-23	134	6160H08	124	6258	110	6436	198
6094-24	134	6160H08L	124	6259	111	6437	199
6094-25	134	6160H09	124	6260	252	6438	199
6094-26	134	6160H09L	124	6265	252	6439	150
6094-27	134	6160H10	124	6270	252	6440	151
6094-28	134	6160H10L	124	6275	252	6441	150
6094-29	134	6160H12	124	6280	252	6442	197
6094-30	134	6160H12L	124	6281	252	6443	150
6094-31	134	6160H14	124	6290	264	6444	198
6094-32	134	6160H17	124	6300	203	6445	198
6094-34	134	6160H38	125	6301	203	6447	282
6094-35	134	6160Q08L	125	6302	203	6449	197
6094-36	134	6160Q10L	125	6306	141	6450	151
6094-37	134	6160R06L	124	6307	202	6451	199
6094-38	134	6160R08L	124	6308	202	6452	199
6095	78	6160R10L	125	6309	201	6453	150
6096	78	6160R12L	125	6310	201	6454	149
6097	78	6160T20	124	6311	202	6455	151
6098	78	6160T20HL	124	6312	199	6460	148
6099	77	6160T25	124	6313	200	6470	170
6100	77	6160T25HL	124	6314	198	6490	179
6101	76	6160T27	124	6314B	198	6509	117
6102	76	6160T27HL	124	6315	202	6510	110
6103	76	6160T30	124	6315M10	202	6514	249
6104	75	6160T30HL	124	6315M12	202	6515	249
6105	76	6160T40	124	6315M14	202	6516	250
6106	77	6160T40HL	124	6315M16	202	6589	228
6107	77	6160T45	124	6316	201	6595	229
6109	209	6160T45HL	124	6317	176	6606	249
6110	209	6160T50	124	6318	176	6642	253
6110S	209	6160T50HL	124	6319	177	6650	252
6111	211	6160T55	124	6320	178	6717	147
6112	211	6160T55HL	124	6321	178	6814	249
6113	68	6160T60	124	6322	177	6825	147
6113S	68	6160T60HL	124	6323	175	6827	149
6115	210	6160X05	124	6324	175	6828	149
6116	212	6160X06	124	6325	188	6900	245
6117	234	6160X08	124	6326	188	6901	246
6118	210	6160X10	124	6327	197	7000	269
6120	211	6160X12	124	6328	204	7000-01	269
6121	213	6160XM05L	124	6329	204	7000-02	269
6122	148	6160XM06L	124	6330	178	7000-03	269

Referência	Páginas	Referência	Páginas	Referência	Páginas	Referência	Páginas
Referencia	Páginas	Referencia	Páginas	Referencia	Páginas	Referencia	Páginas
7000-04	269	7967	113	8330	413	8523	23
7000-05	269	7968	113	8331	414	8523V	23
7000-06	269	7969	115	8332	414	8524	30
7000-07	269	8003	213	8333	414	8524V	30
7000-08	269	8004	53	8334	409	8525	30
7000-09	269	8006	53	8340	413	8525V	30
7000-10	269	8008	53	8353PRE	39	8526	31
7000-11	269	8015	249	8353VER	39	8526V	31
7003	131	8020	423	8354	41	8527	31
7005	131	8021	424	8360	19	8527V	31
7007	270	8022	424	8361	19	8528	28
7008	269	8031	265	8362	19	8528V	28
7009	269	8035	266	8363	20	8529	23
7010	267	8036	266	8364	19	8529V	23
7012	237	8037	265	8365	20	8530	16
7013	271	8100	225	8366	20	8535	17
7014	271	8101	225	8367	21	8536	17
7015	271	8102	225	8368	20	8537	28
7020	271	8102M	225	8369	21	8540	172
7025	271	8103	226	8370	96	8541	153
7030	271	8103M	226	8445	161	8542P	153
7100	214	8104	231	8449	159	8543	155
7105	213	8104C	231	8450	156	8546	154
7110	205	8105	236	8457	396	8546P	154
7110P	205	8106	226	8458	140	8547	154
7111	205	8107	172	8460	157	8548	154
7111P	205	8108	236	8470	157	8549	158
7112	205	8108-03	236	8471	158	8550	160
7112P	205	8108-04	236	8479	158	8553	159
7113	205	8109	236	8480	52	8554	156
7113P	205	8110	232	8497	34	8557	71
7114	205	8111A	228	8498PRE	35	8558	161
7114P	205	8111C	228	8498VER	35	8562	158
7115	205	8112	68	8500PRE	37	8566	88
7133	271	8112S	68	8500VER	37	8568	32
7134	271	8113	227	8501PRE	36	8569	32
7137	271	8114	228	8501VER	36	8570	26
7138	271	8114P	228	8502PRE	38	8571	28
7150	218	8115	225	8502VER	38	8572	29
7160	172	8116	232	8504	52	8573	17
7165	171	8123	86	8507	52	8574	27
7166	210	8124	86	8510	17	8574V	27
7170	210	8125	86	8510V	17	8575	27
7175	210	8150	228	8511	18	8576	22
7314	249	8199	75	8511V	18	8577	52
7414	250	8200	75	8512	21	8578	52
7415	249	8201	131	8512V	21	8579	52
7450	253	8202	308	8513	23	8581	16
7491	219	8203	132	8513V	23	8582	16
7541	217	8240	238	8514	24	8588	24
7545	217	8241	238	8514V	24	8589	25
7546	217	8242	238	8515	18	8590	14
7547	217	8243	238	8515V	18	8591	31
7548	217	8244	238	8516	26	8591V	31
7571	240	8245	238	8516V	26	8592	27
7608	249	8246	239	8517	29	8593	22
7612	249	8247	239	8517V	29	8594	31
7612A	250	8249	238	8518	30	8595	518
7614	249	8250	238	8518V	30	8596	30
7630	249	8251	238	8519	25	8597	32
7815	249	8252	238	8519V	25	8597V	32
7836	104	8253	239	8520	25	8598	29
7962	109	8301	410	8520V	25	8599	25
7963	109	8312	68	8521	27	8600	22
7964	110	8314	67	8521V	27	8601	22
7965	115	8315	408	8522	28	8603	26
7966	113	8325	408	8522V	28	8604	18

Referência	Páginas	Referência	Páginas	Referência	Páginas	Referência	Páginas
Referencia	Páginas	Referencia	Páginas	Referencia	Páginas	Referencia	Páginas
8605	21	8830	51	9087F	206	9275	374
8605V	21	8831	46	9087P	206	9277	369
8606	29	8832	44	9087P8	206	9279	365
8606V	29	8833	44	9087S	206	9283	373
8607	24	8834	45	9087T	206	9285	370
8607V	24	8880	47	9088	179	9312	205
8607VV	24	8881	47	9089	179	9312A100	205
8608	24	8882	48	9120	455	9312A130	205
8609	139	8883	48	9121	456	9312AF100	205
8611	14	8884	48	9121-01	456	9312AF130	205
8612	40	8925	196	9121-02	456	9312E	205
8616	249	8933	209	9121-03	456	9312F	205
8618	249	8933P	209	9121-04	456	9312S	205
8630G	12	8934	207	9121-05	456	9312SM	205
8631	12	8935	207	9121-06	456	9312T	205
8632	15	8939	139	9121-07	456	9315	249
8633	15	9002-07	446	9121-08	456	9319	367
8634	16	9004	446	9121-09	456	9320	206
8640	172	9005	446	9121-10	456	9321	368
8660	13	9007	450	9121-11	456	9325	208
8661	13	9008	451	9121-12	456	9326	204
8670	11	9009	446	9121-13	456	9330	368
8672	12	9015	249	9121-14	456	9335	369
8685	53	9016	434	9121-15	456	9336	249
8686	54	9017	435	9121-16	456	9345	249
8690	15	9018	436	9121-17	456	9376	370
8700	11	9019	457	9121-18	456	9377	369
8725	237	9020	454	9121-19	456	9378	367
8726	237	9021	440	9121-20	456	9380	371
8727	241	9022	443	9121-21	456	9380S	371
8728	241	9023	463	9121-22	456	9381	368
8730	148	9024	465	9121-23	456	9384	371
8739	159	9025	466	9200	365	9385	371
8740	160	9026	464	9202	365	9387	372
8745	155	9027	465	9210F	249	9404	139
8762	304, 348	9028	452	9221	367	9405	139
8763	318	9029	446	9230	368	9500	378
8764	323	9032	441	9235	369	9503	378
8801	42	9033	445	9239	130	9515	249
8802	42	9034	445	9239P	130	9606	244
8803	42	9035	445	9239-T10	130	9607	244
8804	42	9036	447	9239-T15	130	9607FU	244
8805	43	9037	447	9239-T20	130	9608	244
8806	43	9038	447	9239-T25	130	9609	244
8807	43	9039	442	9239-T27	130	9610	243
8808	43	9040	458	9239-T30	130	9615	243
8809	44	9041	459	9239-T40	130	9618	249
8810	45	9045	444	9241	523	9620	276
8811	45	9046	439	9242	366	9620-1	276
8812	45	9047	439	9243	365	9630	237
8813	44	9048	442	9245	366	9700	420
8814	46	9050	447	9246	366	9710	420
8815	46	9051	447	9247	366	9720	426
8816	46	9052	448	9248	367	9725	419
8817	50	9053	448	9250	374	9726	421
8818	50	9054	448	9260	373	9728	422
8819	50	9055	448	9260B	373	9729	422
8820	50	9056	449	9260E	373	9730	421
8821	50	9057	449	9260L20	373	9730M	421
8822	50	9058	449	9260L25	373	9730S3	421
8823	50	9059	449	9260L30	373	9730V	421
8824	50	9073	141	9260L32	373	9730V6	421
8825	50	9073-01	141	9260L40	373	9730V8	421
8826	51	9074	179	9260L60	373	9730VC	421
8827	51	9087	206	9260PV	373	9740	426
8828	51	9087AF	206	9265	374	9740P	426, 427
8829	51	9087AM	206	9266	374	9745	427

Referência	Páginas	Referência	Páginas	Referência	Páginas	Referência	Páginas
Referencia	Páginas	Referencia	Páginas	Referencia	Páginas	Referencia	Páginas
9750	263	9851	481	12038K	69	14122	123
9755	263	9852	482	12039	69	14131	123
9756	263	9853	483	12040	70	14132	123
9760	429	9854	484	12106	61	14141	123
9760-01	429	9855	485	12108	61	14142	123
9760-02	429, 430, 431, 432	9856	485	12109	61	14143	123
9761	428	9857	502	12109L	61, 346	14149	126
9762	428	9858	502	12110	61	14150	68
9765	429	9859	502	12112	61	14151	123
9765-01	429	9860	460	12114	61	14152	123
9765-03	429	9865	461	12116	273	14153	123
9766	433	9866	462	12117	61, 168	14161	123
9767	433	9875	473	12304	61	14162	123
9768	433	9876	475	12305	61	14163	123
9769	433	9876BA	476	12306	61	14164	123
9770	430	9881	470	12307	61	14171	123
9770-56	430, 431, 432	9882	471	12308	61	14172	123
9770PL	430	9885	469	12309	61	14173	123
9770PV	430	9891	487	12310	61	14174	123
9771	431	9891R	487, 488	12312	61	14181	123
9772	432	9892	487	12313	61	14182	123
9772PL	431, 432	9893	488	12314	61	14183	123
9772PV	431, 432	9896	485	12407	125	14184	123
9773	432, 433	9897	486	12408	126	14185	123
9774	433	9900	362	12410	126	14186	123
9775	427	9910	362	12411	125	14187	123
9797	501	10015	249	12412	125	14190	123
9798	476	10106	98	12430	73	14191	123
9799	476	10108	98	12432	73	14192	123
9801	468	10110	98	12443	68	14193	123
9801-380	468	10112	98	12460	73	14194	123
9802	479	10115	98	12500	66	14195	123
9805	472	10118	98	13007	114	14196	123
9805B2	472	10124	98	13010	114	14197	123
9805B2F	472	10430	123	13016	273	14201	123
9805BR	472	10475	124	13021	273	14202	123
9805MO	472	10530	123	13300	89	14203	60
9807	478	10575	124	13300P	89	14204	60
9807MO	478	10615	249	13500	89	14205	60
9809	474	10630	123	13500P	89	14206	125
9809MO	474	10675	124	13800	89	14207	123
9810	492	10730	123	13800P	89	14208	123
9810MO	492	10775	124	13816	272	14209	123
9812	491	10815	249	13821	272	14210	123
9815	493	10818	249	14008	91	14211	123
9815M	493	10830	123	14009	91	14212	123
9816	501	10875	124	14010	91	14213	123
9817	495	11030	123	14011	91	14214	123
9818	494	11075	124	14012	91	14215	123
9818MO	494	11300	89	14013	91	14216	60
9819	490	11300P	89	14014	91	14217	123
9822	496	11500	89	14015	91	14218	123
9823	498	11500P	89	14016	91	14219	123
9824	497	11800	89	14017	91	14220	123
9828	487	11800P	89	14018	91	14221	123
9830	489	12012	70	14019	91	14222	123
9832	499	12012K	70	14020	91	14223	123
9833	500	12012Q	70	14021	91	14224	60
9839	488	12013	70	14022	91	14225	60
9839BP	488	12014	69	14023	91	14230	73
9841	488	12014K	69	14111	60	14235	60
9842	480	12015	69	14112	60	14240	60
9843	486	12016	273	14113	60	14255	60
9844	486	12017	71	14114	60	14260	60
9845	477	12018	69	14115	60	14270	60
9850	467	12021	273	14116	60	14305	123
9850P	467	12038	69	14121	123	14306	123

Referência	Páginas	Referência	Páginas	Referência	Páginas	Referência	Páginas
Referencia	Páginas	Referencia	Páginas	Referencia	Páginas	Referencia	Páginas
14308	60	21075	124	34640	73	111213	92
14308H	60	21110	82	34641	74	111415	92
14309	60	21230	124	34642	75	111617	92
14309H	60	21275	124	74715	251	111819	92
14310	60	22030	124	86236	33	112022	92
14310H	60	22075	124	100000	85	112123	92
14315	60	22530	124	100001	71	112427	92
14315H	60	22575	124	100001K	71	112528	92
14316	60	22730	124	100002	66	113032	92
14316H	60	22775	124	100003	66	120006	92
14320	73	23030	124	100004	68	120007	92
14321	74	23075	124	100005	65	120008	92
14325	60	24030	124	100008	93	120009	92
14325H	60	24075	124	100012	94	120010	92
14327	60	24575	124	100607	91	120011	92
14327H	60	25030	124	100636	58	120012	92
14330	60	25075	124	100637	58	120013	92
14330H	60	25530	124	100638	58	120014	92
14331	60	25575	124	100639	58	120015	92
14340	73	26030	124	100640	58	120016	92
14500	66	26075	124	100641	58	120017	92
15007	114	30001	180	100642	58	120018	92
15010	114	30002	180	100643	58	120019	92
15012	115	30003	180	100644	58	120020	92
15016	115	30004	180	100645	58	120021	92
16007	114	30005	180	100646	58	120022	92
16010	114	30006	180	100647	58	120023	92
16012	115	30007	181	100648	58	120024	92
17008	91	30008	181	100649	58	120025	92
17009	91	30009	181	100650	58	120026	92
17010	91	30010	181	100652	58	120027	92
17011	91	30011	181	100654	58	120028	92
17012	91	30012	181	100655	58	120029	92
17013	91	30013	182	100656	59	120030	92
17014	91	30014	182	100657	59	120032	92
17015	91	30015	182	100658	59	120034	92
17016	91	30016	182	100659	59	120036	92
17017	91	30017	182	100660	59	120038	92
17018	91	30018	183	100663	59	120040	92
17019	91	30019	183	100665	59	120041	92
17021	91	30020	183	100670	59	120042	92
17022	91	30021	183	100675	59	120046	92
17023	91	30022	183	100680	59	120048	92
18008	93	30023	183	100809	91	120050	92
18009	93	30024	184	101011	91	120200	96
18010	93	30025	184	101213	91	120208	91
18011	93	30026	184	101415	91	120209	91
18012	93	30027	184	101617	91	120210	91
18013	93	30028	184	101819	91	120211	91
18014	93	30029	184	102022	91	120212	91
18015	93	30030	185	102123	91	120213	91
18016	93	30031	185	102427	91	120214	91
18017	93	30032	185	102528	91	120215	91
18018	93	30033	185	103032	91	120216	91
18019	93	30034	185	104013X1.5	266	120217	91
20085	169	30035	185	104013X1.25	266	120218	91
20095	169	30036	186	104015X1.5	266	120219	91
20115	169	30037	182	104017X1.5	266	120402	101
20120	169	34021	71	104020X1.5	266	120403	101
20130	169	34021K	71	104022X1.5	266	120404	101
20530	124	34022	67	110005L	98	120405	101
20575	124	34023	67	110008	95	120406	101
20630	124	34024	67	110012	96	120510	101
20675	124	34612	74	110200	97	120515	101
20830	124	34613	74	110607	92	120520	101
20875	124	34614	74	110809	92	120525	101
21030	124	34615	74	111011	92	120527	101

Referência	Páginas	Referência	Páginas	Referência	Páginas	Referência	Páginas
Referencia	Páginas	Referencia	Páginas	Referencia	Páginas	Referencia	Páginas
120530	101	121221	56	125055	57	134175	119
120608	55	121221L	56	125060	57	134200	119
120609	55	121222	56	125070	57	135125	119
120610	55	121222L	56	125100	170	135175	119
120610L	55	121223	56	125511	60	136125	119
120611	55	121223L	56	126004	60	136175	119
120611L	55	121224	56	126005	60	137125	119
120612	55	121224L	56	126006	60	137175	119
120612L	55	121225	56	126007	60	138200	118
120613	55	121226	56	126008	60	140000	120
120613L	55	121226L	56	126010	60	140001	23
120614	55	121227	56	126012	60	140002	120
120614L	55	121227L	56	126014	60, 134	140003	120
120615	55	121228	56	126017	60, 134	140004	120
120615L	55	121228L	56	126019	60, 134	140005	120
120616	55	121229	56	126020	60	140006	120
120616L	55	121229L	56	126025	60	140007	120
120617	55	121230	56	126027	61	140008	120
120617L	55	121230L	56	126030	61	140009	120
120618	55	121232	56	126040	61	140010	120
120618L	55	121232L	56	126045	61	140011	120
120619	55	122200	96	126050	61	140012	120
120619L	55	123005	57	126055	61	140013	120
120620	55	123006	57	126060	61	140014	120
120620L	55	123007	57	128529	59	140015	120
120621	55	123008	57	128530	59	140016	120
120621L	55	123009	57	128531	59	140017	120
120622	55	123010	57	128532	59	140018	120
120622L	55	123011	57	128533	59	140019	120
120623	55	123012	57	128534	59	140020	120
120624	55	123013	57	128535	59	140021	120
120624L	55	123014	57	128536	59	140150	118
120625	55	123104	61	128538	59	140175	118
120626	55	123105	61	130150	118	140200	118
120627	55	123106	61	130175	118	140604	54
120627L	55	123107	61	130200	118	140604L	54
120628	55	123108	61	130608	55	140605	54
120629	55	123109	61, 134	130609	55	140605L	54
120629L	55	123110	61	130610	55	140606	54
120630	55	123112	61	130610L	55	140606L	54
120630L	55	123113	61	130611	55	140607	54
120632	55	123114	61	130611L	55	140607L	54
120632L	55	124004	57	130612	55	140608	54
121208	55	124005	57	130612L	55	140608L	54
121209	55	124006	57	130613	55	140609	54
121210	55	124008	57	130613L	55	140609L	54
121210L	56	124009	57	130614	55	140610	54
121211	55	124010	57	130614L	55	140610L	54
121211L	56	124012	57	130615	55	140611	54
121212	56	124014	57	130615L	55	140611L	54
121212L	56	124016	57	130616	55	140612	54
121213	56	125004	57	130617	55	140612L	54
121213L	56	125005	57	130618	55	140613	54
121214	56	125006	57	130619	55	140613L	54
121214L	56	125008	57	130621	55	140614	54
121215	56	125010	57	130622	55	140614L	54
121215L	56	125012	57	130624	55	140645	54
121216	56	125014	57	130630	55	140655	54
121216L	56	125017	57	131150	118	141150	118
121217	56	125019	57	131175	118	141200	118
121217L	56	125020	57	132125	119	141204	54
121218	56	125025	57	132175	119	141204L	54
121218L	56	125027	57	132500	120	141205	54
121219	56	125030	57	133150	118	141205L	54
121219L	56	125040	57	133175	118	141206	54
121220	56	125045	57	133200	118	141206L	54
121220L	56	125050	57	134150	119	141207	54

Referência	Páginas	Referência	Páginas	Referência	Páginas	Referência	Páginas
Referencia	Páginas	Referencia	Páginas	Referencia	Páginas	Referencia	Páginas
141207L	54	201213	91	234103	99	235203	99
141208	54	201415	91	234104	99	235204	99
141208L	54	201617	91	234105	99	235205	99
141209	54	201819	91	234106	99	235301	100
141209L	54	202022	91	234107	99	235302	100
141210	54	202123	91	234108	99	235303	100
141210L	54	202427	91	234109	99	235304	100
141211	54	202528	91	234201	99	235305	100
141211L	54	203032	91	234202	99	235306	100
141212	54	203236	91	234203	99	235307	100
141212L	54	203641	91	234204	99	235308	100
141213	54	204146	91	234205	99	235309	100
141213L	54	204650	91	234301	100	235310	100
141214	54	210008	95	234302	100	235401	100
141214L	54	210012	96	234303	100	235402	100
143150	118	210607	93	234304	100	235403	100
143200	118	210809	93	234305	100	235404	100
144150	119	211011	93	234306	100	235501	99
144200	119	211213	93	234307	100	235502	99
150006L	98	211415	93	234308	100	235503	99
191501	153	211617	93	234309	100	235504	99
191502	153	211819	93	234310	100	235505	99
191503	153	212022	93	234401	100	235510	60
191504	153	212123	93	234402	100	235515	60
191505	153	212427	93	234403	100	235520	60
191506	153	212528	93	234404	100	235525	60
191507	153	213032	93	234501	99	235527	60
191508	153	213236	93	234502	99	235530	60
192001	152	213641	93	234503	99	235540	60
192002	152	220006	92	234504	99	235545	60
200000	85	220007	92	234505	99	235550	60
200006	67	220008	92	234601	99	235601	99
200007	67	220009	92	234602	99	235602	99
200008	67	220010	92	234603	99	235603	99
200009	68	220011	92	234604	99	235604	99
200010	75	220012	92	234700	101	300008	93
200012	94	220013	92	234702	102	340617	57
200119	59	220014	92	234703	102	340619	57
200121	59	220015	92	234704	102	340621	57
200123	59	220016	92	234705	102	340622	57
200124	59	220017	92	234706	102	340623	57
200126	59	220018	92	234707	102	340624	57
200127	59	220019	92	234708	102	340626	57
200128	59	220020	92	234710	102	340627	57
200129	59	220021	92	234712	102	340628	57
200130	59	220022	92	234714	102	340629	57
200132	59	220023	92	234800	102	340630	57
200133	59	220024	92	234810	103	340632	57
200134	59	220025	92	234815	103	340633	57
200136	59	220026	92	234820	103	340634	57
200138	59	220027	92	234825	103	340635	57
200140	59	220028	92	234827	103	340636	57
200141	59	220029	92	234830	103	340638	57
200142	59	220030	92	234840	103	340641	57
200146	59	220032	92	234845	103	340646	57
200150	59	220033	92	234850	103	340650	57
200155	59	220034	92	235101	99	340655	57
200156	59	220035	92	235102	99	340660	57
200160	59	220036	92	235103	99	341217	57
200163	59	220038	92	235104	99	341219	57
200165	59	220041	92	235105	99	341221	57
200170	59	220042	92	235106	99	341222	57
200175	59	220046	92	235107	99	341223	58
200180	59	220048	92	235108	99	341224	58
200607	91	220050	92	235109	99	341225	58
200809	91	234101	99	235201	99	341226	58
201011	91	234102	99	235202	99	341227	58

Referência	Páginas	Referência	Páginas	Referência	Páginas
Referencia	Páginas	Referencia	Páginas	Referencia	Páginas
341228	58	1261208	61	TENT33	514
341229	58	1261250	61	TENT36	514
341230	58	1261405	60	TROTINETE	513
341232	58	1261406	60	T-SHIRT	506
341233	58	1261408	60	T-SHIRT-MC	506
341234	58	1261410	60, 134		
341235	58	1261412	60		
341236	58	1261440	61		
341238	58	1261445	61		
341241	58	1261450	61		
341246	58	1261455	61		
341250	58	1261460	61		
341255	58	1261470	61		
341260	58	1300012	94		
381214	272	1300025	94		
381214L	273	1412045	54		
381216	272	1412055	54		
381216L	273	2347025	102		
481603	389	2347035	102		
481604	389	2347045	102		
656714	249	6516246	250		
700317	131	6516276	250		
700319	131	6516306	250		
700321	131	6516366	250		
747615	249	6516386	250		
757715	249	65163256	250		
808215	249	65166314	250		
981015B18040	492, 493	65167014	250		
981015B18080	492, 493	65167414	250		
1200008	95	65167915	250		
1200012	94	65168414	250		
1200025	94	65168716	250		
1204025	101	65169215	250		
1211005	61	651610015	250		
1211006	61	651666514	250		
1211008	61	651679514	250		
1211009	61, 134	651694515	250		
1211010	61	BAGKR	513		
1211012	61	BONE	506		
1211014	61	CASACO	505		
1211016	61, 134	COLETE	505		
1211210	61	DISP3	524		
1211405	61	DISP5	524		
1211406	61	DISP6	524		
1211408	61	DISP7	524		
1211410	61, 134	DISP8	520		
1211410R	61	DISP9	519		
1211412	61, 134	DISP10	522		
1211414	61, 134	DISP11	523		
1261004	60	DISP12	521		
1261005	60	DISP13	517		
1261006	60	FLAG33	514		
1261008	60	FLAG45	514		
1261010	60	FLAGB	513		
1261012	60	GARRAFA	512		
1261014	60	GUARDA-CHUVA	511		
1261020	61	KIT90169018	437		
1261025	61	KIT90179018	438		
1261027	61	LUVAS	506		
1261030	61	MULTITOOL	512		
1261040	61	NOTEBOOK	512		
1261045	61	PEN	512		
1261050	61	POLO	505		
1261055	61	PORTA-CHAVES	512		
1261060	61	PROTETOR-SOL	511		
1261070	61	ROCK	511		
1261111	60	SWEATSHIRT	505		

K25

WHEREVER WE GO, WE GO TOGETHER



Distribuidor:

