



TABELA DE PREÇOS

2024

Validade 28/02/2025



Empreendimento Empresarial da Portugal

Bolas - Máquinas e Ferramentas de Qualidade, S.A.

SEDE E ARMAZÉM CENTRAL

Zona Industrial Américo de Noz
Rua Sebastião Mendes Bolas, 77
4465-031 ESTRELA
Ap. 52 FC, Rua da 2766-401 ÉvORA - Portugal
Telf: 266 749 300 | 61111111 | Fax: 266 746 305
Email: geral@bolas.pt

DELEGAÇÃO LISBOA

ALVERÇA PARQUE NÚCLEO EMPRESARIAL
Estrada Nacional 10, km 126 E
2615-900 SIONALINDO
Ap. 78 FC ALVERÇA
2615-907 ALVERÇA DO RIBATEJO - Portugal
Telf: 218 086 700 | 218 086 705
Email: lisboa@bolas.pt

DELEGAÇÃO NORTE

CENTRO DE NEGÓCIOS DO FREIXE RO
Rua Américo de Noz, 200
4465-031 ESTRELA
Ap. 5142 FC FREIXE RO
4456-601 PERAFITA - Portugal
Telf: 229 947 000 | Fax: 229 975 108
Email: n.orte@bolas.pt

BETA SIGNIFICA
AUDÁCIA. COMPROMISSO. HARMONIA. TALENTO.



Na Beta, só existe uma forma de fazer as coisas: fazê-las bem.

Este é o mundo Beta, este é o princípio que guia o nosso trabalho diário em todo o mundo, driven by four values:

AUDÁCIA *investir e desenvolver constantemente uma empresa criada por um artesão Italiano em 1923, que se afirmou mundialmente e continua a crescer após quatro gerações.*

COMPROMISSO *em garantir a qualidade dos nossos produtos, porque cada revendedor sabe que pode contar com um atendimento eficiente, e cada utilizador sabe que pode contar com a precisão, fiabilidade e resistência dos produtos Beta.*

HARMONIA *das linhas, para um design de excelência, porque quando algo é bem feito, expressa um equilíbrio perfeito entre a função e o design.*

TALENTO *é o nosso recurso mais valioso, aquele que distingue todos os nossos colaboradores e que leva cada profissional a optar pela Beta para não deixar nada ao acaso, na realização cativante e apaixonada das suas ideias e sonhos.*

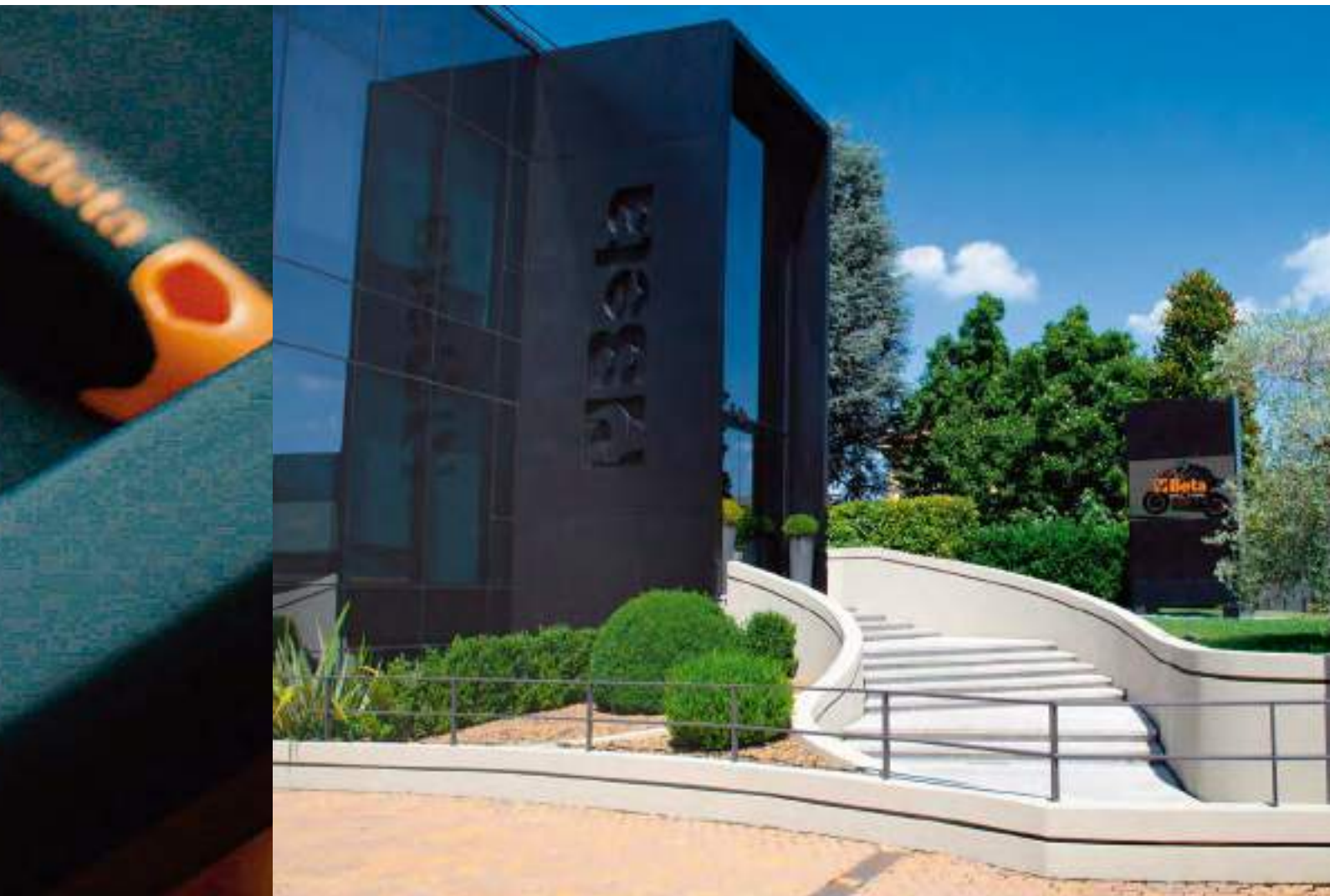

ÍNDICE



Índice	4
Guia de leitura	8
Áreas de aplicação de chaves e barras dinamométricas.....	58-59
Quadro de jogos e malas de ferramentas.....	351, 479-480
Artigos eliminados – artigos de substituição/recomendados ...	727÷729
Índice alfabético	730÷734
Índice para ferramentas de veículos automóveis	735÷737
Índice Alfanumérico	738÷753
Grupo beta – os números	754
A história das ferramentas italianas	755
Controlo e qualidade	756
Control and quality	757
Logística.....	758
Organização do trabalho	759
Presença efi caz.....	760

ÍNDICE

MOBILIÁRIO PARA OFICINA **RSC55**



RSC55

410÷435; 475÷478

MOBILIÁRIO PARA OFICINA **RSC50**



Beta
RSC50

436÷453; 475÷478

MOBILIÁRIO PARA OFICINA **C45PRO**



Beta
C45PRO

454÷478

JOGOS DE FERRAMENTAS E MALAS



351÷370



371÷400



383; 401÷409



479÷561

CHAVES DE APERTO



11÷17

23÷27

112÷117

CHAVES DE CAIXA E ACESSÓRIOS



69÷78

85÷112

CHAVES DINAMOMÉTRICAS E MULTIPLICADORES DE BINÁRIO



54÷56

57÷69

CHAVES DE PARAFUSOS, CHAVES EXTREMIDADE MACHO E PONTAS



18÷23

78÷85

114÷117

145÷159

ALICATES E ALICATES DE CORTE



127÷134

139÷142

236

FERRAMENTAS ISOLADAS 1000V



285÷291

FERRAMENTAS EM AÇO INOX



299÷303

FERRAMENTAS ANTI-FAÍSCA



304÷312

REPARAÇÃO DE VEÍCULOS



118÷125

160÷166



170÷198; 204÷208

229÷232

232÷238

EQUIPAMENTO PARA OFICINA



254÷273

FERRAMENTAS PARA MOTOCICLOS



274÷279

FERRAMENTAS PARA BICICLETAS



280÷284

PRODUTOS ELÉTRICOS



313÷324

FERRAMENTAS PNEUMÁTICAS E ACESSÓRIOS



327÷350

FERRAMENTAS ANTI-QUEDA



292÷298

BETA CHEMICALS

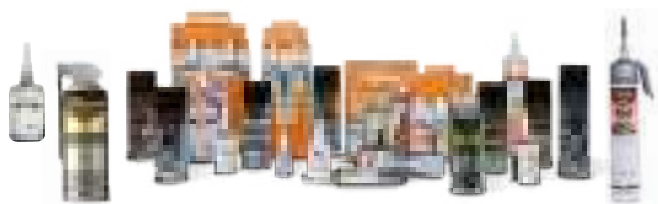

562÷567

CALÇADO DE SEGURANÇA (E MEIAS TÉCNICAS)



624÷649

BETA ABRASIVES



568÷584

VESTUÁRIO DE TRABALHO



650÷670

PRODUTOS DA MARCA BM



588÷594

GAMA BLISTER

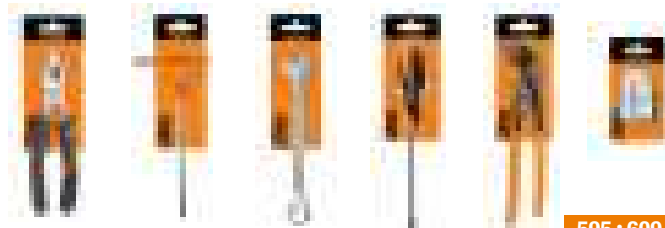

595÷609

ROBUR ACESSÓRIOS PARA CABOS

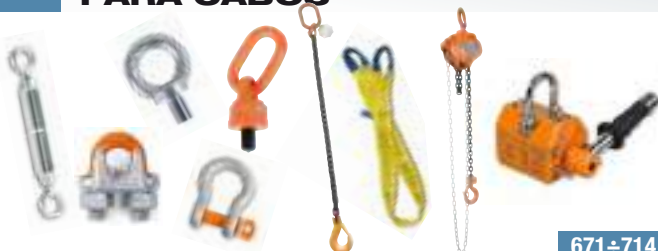

671÷714

EXPOSITORES PARA PONTOS DE VENDA

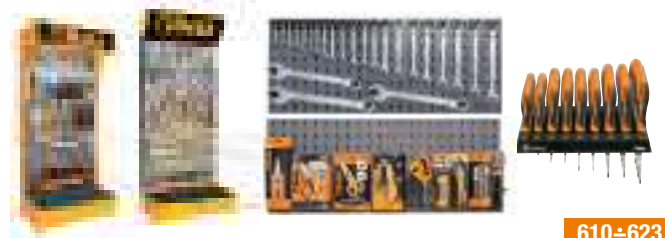

610÷623

BETA COLLECTION



715÷726

GUIA DE LEITURA

Referência

951GP

chave em T com macho sextavado
A chave Beta 951GP é sinónimo de um ajuste rápido e preciso. Concebida para satisfazer alguns requisitos importantes do mundo das corridas: desenvolver valores de binário elevados e garantir um aperto rápido.

em blister

Ferramentas para motociclos

Ferramentas para bicicletas

Perfil da ferramenta

Preço unitário

★ artigo disponível a pedido

- tamanho principal
- encadouro sextavado

Dimensão

Quantidade por caixa

Quantidade de peças por jogo

Símbolo da embalagem

Conteúdo da série

mm	L mm	L1 mm	Ø mm	€	Quantidade	Código
3	185	130	5	20,80	3	009511530
4	214	150	5	21,80	3	009511540
5	240	165	6	25,00	3	009511550
6	271	180	7	29,00	3	009511560
8	300	200	10	37,00	3	009511580
10	310	200	12	46,00	3	009511610

Código

Novidade 2024

951GP/S6	€	Quantidade	Código
3-4-5-6-8-10 mm	180,00	1	009511687

Significado dos símbolos mais usados

Exemplo

Em jogos	
B	= Em bolsa plástica 42/B9N
BV	= Bolsa plástica vazia 2002/BV9
C	= Em caixa metálica 900/C11
D	= Em caixa expositora 1293/D6
S	= Em caixa de cartão 42/S17
SP	= Em expositor 42/SP25
SPV	= Expositor vazio 42/SPV7
SC	= com suporte compacto 96/SC9
SCV	= suporte compacto, vazio 96/SCV

Assortments

AS	= Com ferramentas em polegadas 5915VU/AS
E	= Para electrónica/electrotécnica 5980ET/A
I	= Para a hidráulica 5980ID
MT	= Para movimentação de terras 5902MT
U	= Para reparação universais 5915VU/3
SBK	= Para reparação de motociclos 5940SBK
VG	= Para reparação auto 5904VG/5T
VI	= Para manutenção industrial 5902VI

Em chaves de caixa

A	= Perfil de 6 faces 910A
B	= Perfil de 12 faces 910B
ES	= Perfil dentado 920ES
FTX	= Parafusos TORX® 910FTX

Significado dos símbolos mais usados

Exemplo

PT	= Para parafusos com cabeça de 5 nervuras 910PT
X	= Roquete reversível em caixa metálica 920A/C12X

Em chaves para parafusos e pontas para aparafusadoras

LP	= Para parafusos de fenda 920LP
PE	= Para parafusos hexagonais 920PE
PH	= Para parafusos PHILLIPS® 920PH
PZ	= Para parafusos POZIDRIV® - SUPADRIV® 1299PZ
RTX	= Para parafusos TAMPER RESISTANT TORX® 1298RTX
SP	= Para parafusos SPANNER 861SP
TRW	= Para parafusos TRI-WING® 861TRW
TQS	= Para parafusos TORQ-SET® 861TQS
TX	= Para parafusos TORX® 920TX
XZN	= Para parafusos XZN® 920XZN

Na generalidade

AS	= Medidas em polegadas 42AS
BA	= Ferramenta anti-faísca 42BA
BM	= Punho com dois materiais 1150BM
C	= Caixa metálica vazia C25
HS	= Ferramentas anti-queda 42HS
INOX	= ferramentas em aço inoxidável 42 INOX
L	= Modelo longo 952L
MQ	= Isolamento até 1000V 1150MQ
MP	= Cromado brilhante 42MP
R	= Peça de reposição 338R

Todas as informações e imagens que aparecem neste catálogo são meramente indicativas e sem qualquer valor contratual. A Beta Utensili reserva-se ao direito de alterar ou actualizar a sua gama de produtos sem aviso prévio, e sem obrigação de efectuar qualquer modificação sobre os modelos vendidos anteriormente.



Beta RECOMENDA a utilização da ferramenta adequada à tarefa a desempenhar, respeitando as normas de segurança individual.



SACA-TROÇOS

As ferramentas de impacto Beta são concebidas para uma ótima performance e para garantir a segurança do operador.

É utilizado um tipo especial de aço cromado com molibdénio e vanádio (65CrMoV2-2) na produção, resultando em ferramentas de extraordinária dureza e robustez. Os produtos são fabricados com barras de tração – desde que a sua geometria o permita; caso contrário, são forjados a quente em atmosfera controlada, para evitar a formação de escória.

1 Os perfis sextavados previnem que a ferramenta role na superfície de apoio.

2 Os saca-troços possuem veios muito longos, robustos e perfeitamente retos, para acesso a espaços confinados

3 Para assegurar que os saca-troços têm dimensões perfeitas, todas as peças têm um componente cilíndrico uniforme e uma extremidade perfeitamente plana, para maior eficiência.

4 Todas as faces são temperadas por indução, para evitar a cisão; a deformação do ponto de embate é uma consequência natural que garante a segurança do operador.

5 Os saca-troços são afiados após serem cromados, para melhor desempenho de corte e gravação e para remoção do depósito galvânico das pontas. É necessário remover depósitos adicionais, de forma a impedir o "arredondamento" dos cantos e a fragilidade resultantes da quantidade de hidrogénio produzido durante a galvanização. As áreas trabalhadas possuem revestimento de proteção antiferrugem.



30

punções



Ø mm	L mm	€	📦	📄
2	125	8,30	10	000300020
3	125	8,30	10	000300030
4	150	11,10	10	000300040
5	150	11,10	10	000300050
6	150	11,60	10	000300060

31

saca-troços



Ø mm	L mm	L1 mm	€	📦	📄
2	110	22	8,30	10	000310002
3	128	35	8,60	10	000310003
4	146	45	10,50	10	000310004
5	164	55	11,10	10	000310005
6	182	65	13,90	5	000310006
8	200	80	14,70	5	000310008
10	220	95	18,40	5	000310010



31/B6N	76,50	1	000310024
2-3-4-5-6-8 mm			
2002/BV6	10,00	1	020020000
31/SP6	90,50	1	000310030
2-3-4-5-6-8 mm			
31/SPV	22,90	1	000310031

31BM

saca-troços com punho



Ø mm	L mm	L1 mm	€	📦	📄
2	168	42	16,90	2	000310402
3	180	52	17,40	2	000310403
4	191	62	19,00	2	000310404
5	200	72	20,00	2	000310405
6	221	82	22,90	2	000310406
8	235	94	24,10	2	000310408



31BM/D6	120,00	1	000310420
2-3-4-5-6-8 mm			

31L

saca-troços série longa



Ø mm	L mm	L1 mm	€	📦	📄
4	175	80	12,50	5	000310104
5	175	80	13,30	5	000310105
6	175	80	15,70	5	000310106

31SE

saca-troços para cavilhas elásticas



Ø mm	D mm	L mm	L1 mm	€	📦	📄
4	2,4	175	80	12,50	5	000310204
5	3,0	175	80	13,30	5	000310205
6	3,6	175	80	15,70	5	000310206



31/B6N-LSE	93,00	1	000310324
31L: 4-5-6 mm			
31SE: 4-5-6 mm			
2002/BV6	10,00	1	020020000

32

punções de bico



Ø mm	L mm	L1 mm	€	📦	📄
3	100	44	7,70	10	000320100
4	125	52	9,50	10	000320125
5	150	62	11,60	10	000320150

32AU

punção de bico automático



Ø mm	L mm	L1 mm	€	📦	📄
3	150	23	62,50	2	000320160

32AUR

ponteira de substituição



Ø mm	€	5	000320170
3	11,30		

33IT

punções de letras

- Para gravação em aço com resistência R até 80 kg/mm²
- Kit de 27 punções: letras A a Z + &



H mm	L mm	A mm	€	1	000330023
3	60	6,35	70,00		
4	63	7,93	85,50		
5	61	7,93	85,50		
6	68	9,52	105,00		
8	70	12,7	157,00		

33NR

punções de números

- Para gravação em aço com resistência R até 80 kg/mm²
- Kit de 9 punções: números 0 a 9



H mm	L mm	A mm	€	1	000330003
3	61	6,35	24,90		
4	62	7,93	30,00		
5	62	7,93	30,00		
6	68	9,52	36,50		
8	71	12,7	53,50		

34

escopros planos



L mm	A mm	L1 mm	€	5	000340001
125	14,5	45	11,90		
150	17,0	58	15,60		
175	21,5	68	22,60		

35

escopros planos série nervurada



L mm	A mm	€	5	000350001
100	14,5	14,00		
125	17,0	15,60		
150	20,5	19,50		
200	23,0	29,50		
250	28,5	42,00		
300	34,0	58,00		

35PM

escopros planos série nervurada com punho de protecção



L mm	A mm	€	2	000350014
200	23,0	44,00		
250	28,5	57,00		
300	34,0	73,50		

35PMR

punhos de protecção



L mm	€	1	000350024
200	14,70		
250	14,70		
300	15,40		

36

buris série normal



L mm	A mm	L1 mm	€	5	000360001
125	4	44	12,50		
150	6	53	14,70		

37

buris série nervurada



L mm	A mm	L1 mm	€	5	000370001
150	6	45	22,40		
200	8	55	32,00		

37PM

buril nervurado com punho de protecção



L mm	A mm	€	2	000370012
200	8	47,50		

37PMR

punho de protecção de substituição



L mm	€	1	000370022
200	15,40		

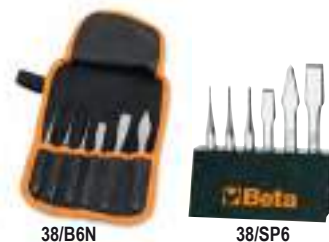

38/B6N

38/SP6

€	1	000380016
78,00		
38/B6N		
30: 2-3 mm		
32: 4 mm		
34: 125-150 mm		
36: 150 mm		
2002/BV6	10,00	1 020020000
38/SP6	92,50	1 000380009
30: 2-3 mm		
32: 4 mm		
34: 125-150 mm		
36: 150 mm		
38/SPV	26,00	1 000380019



A CHAVE ICÓNICA DA BETA

A nossa icónica chave 42 tem um novo formato. Uma forma estreita realçada por um perfil fino, mais leve ao toque, com espessura da cabeça reduzida ao mínimo, para permitir um fácil acesso a todos os espaços. A força, robustez e rapidez de utilização da chave Beta permite alcançar valores ainda melhores, proporcionando aos utilizadores a melhor ferramenta possível. O processo de fabrico desenvolve-se nas nossas fábricas de Sovico e Sulmona, com tecnologia de automação avançada e os melhores técnicos especializado

RAPIDEZ

Um ângulo de 15° em relação ao eixo, para reduzir o ângulo de penetração

RESISTÊNCIA

Força extraordinária: em caso de utilização incorreta, a chave deforma-se, sem quebrar de forma súbita

HOMOGENIA

A prensagem realiza-se num produto semiacabado arredondado, que resulta na distribuição homogénea das fibras, prevenindo a formação de tensão interna

ACESSIBILIDADE

Espessura reduzida para melhor alcance

PROTEÇÃO

Revestimento cromado em níquel para maior resistência aos agentes externos e cumprimento dos exigentes requisitos dos testes de aderência da ISO 2819

FORÇA

A chave, de comprimento maior que a maioria das concorrentes, permite alcançar apertos elevados com pouco esforço



ERGONOMIA

Luneta a 15° para proteção da mão. A sua forma é obtida a partir de um molde, ou seja, a curvatura não é conferida à posteriori



42

chaves mistas

Os valores de binário atingiram mais do dobro em relação aos requisitos a satisfazer ao abrigo da norma ISO 1711



DIN 3113 UNI-ISO 7738

mm	L mm	S1 mm	€	🔧	📦
5,5x5,5	95	3,4	8,10	5	000421005
6x6	95	3,4	8,20	5	000421006
7x7	105	3,6	8,30	5	000421007
8x8	116	3,9	8,50	5	000421008
9x9	127	4,2	9,00	5	000421009
10x10	137	4,5	9,20	5	000421010
11x11	148	4,8	9,80	5	000421011
12x12	158	5,1	10,00	5	000421012
13x13	169	5,6	10,00	5	000421013
14x14	180	5,7	11,50	5	000421014
15x15	190	6,0	12,70	5	000421015
16x16	201	6,3	13,10	5	000421016
17x17	212	6,8	13,80	5	000421017
18x18	222	7,0	14,60	5	000421018
19x19	233	7,5	15,10	5	000421019
20x20	243	7,7	16,90	3	000421020
21x21	254	7,9	18,20	3	000421021
22x22	264	8,3	18,80	3	000421022
23x23	275	8,5	20,30	3	000421023
24x24	285	8,7	21,30	3	000421024
25x25	296	8,7	22,70	2	000421025
26x26	307	8,9	24,40	2	000421026
27x27	317	9,1	26,50	2	000421027
28x28	328	9,3	27,00	2	000421028
29x29	338	9,5	30,00	2	000421029
30x30	349	9,7	31,00	2	000421030
32x32	370	10,1	34,00	2	000421032
34x34	391	10,5	65,00	1	000421034
35x35	412	10,7	70,00	1	000421035
36x36	412	10,7	73,00	1	000421036
38x38	433	11,3	80,50	1	000421038
41x41	465	12,0	89,50	1	000421041



42/B9N	€ 106,00	🔧 1	📦 000421074
6-7-8-10-11-13-14-17-19 mm			
2002/BV9	€ 12,70	🔧 1	📦 020020030



ATENÇÃO!

A forma da chave 42 é perfeitamente compatível com todos os jogos e módulos da chave 42 estabelecida





	€	🔧	📦
42/S14 6-7-8-10-11-12-13-14 -15-16-17-19-22-24 mm	170,00	1	000421067
42/S17 6-7-8-9-10-11-12-13-14-15 16-17-18-19-20-21-22 mm	207,00	1	000421065
42/S15 6-7-8-10-11-12-13-14 17-19-22-24-27-30-32 mm	236,00	1	000421066
42/S17X 6-7-8-10-11-12-13-14- 15-16-17-19-21-22- 24-27-30 mm	246,00	1	000421068
42/S26 6-7-8-9-10-11-12-13-14 15-16-17-18-19-20-21 22-23-24-25-26-27-28 29-30-32 mm	444,00	1	000421070

42/SC9I-E

Conjunto de 9 chaves mistas com suporte compacto

Os valores de binário atingiram mais do dobro em relação aos requisitos a satisfazer ao abrigo da norma ISSO 1711



	€	🔧	📦
42/SC9I 8-10-11-12-13-14-15-17-19 mm	109,00	1	000421087
142/SCV9I	11,50	1	001420103
42/SC9E 8-10-11-12-13-16-17-18-19 mm	113,00	1	000421088
142/SCV9E	11,50	1	001420104



	€	🔧	📦
42/SP25 6-7-8-9-10-11-12-13-14 15-16-17-18-19-20-21 22-23-24-25-26-27-28 30-32 mm	477,00	1	000421085
42/SPV2	69,00	1	000420090



42/SP15

42/SPV...

	€	🔧	📦
42/SP15 6-7-8-9-10-11-12-13-14-15 16-17-19-22-24 mm	186,00	1	000421078
42/SPV7 42: 8-10-11-13-14-17-19 mm 55: 6x7-8x9-10x11-12x13 14x15-16x17-18x19 mm	8,20	1	000420097
42/SPV11 42MP: 8-9-10-11-12-13 14-15-16-17-19 mm	11,50	1	000420100
142-142SN : 8-9-10-11-12-13 14-15-16-17-19 mm			
42/SPV15 42: 6-7-8-9-10-11-12-13-14 15-16-17-19-22-24 mm	15,50	1	000420102

42AS

chaves mistas boca/luneta



🔧	L mm	€	🔧	📦
1/4x1/4	95	10,10	2	000420106
9/32x9/32	106	10,20	2	000420107
5/16x5/16	116	10,30	2	000420108
3/8x3/8	137	11,40	2	000420110
7/16x7/16	148	12,20	2	000420111
1/2x1/2	169	12,60	2	000420113
9/16x9/16	180	13,70	2	000420114
19/32x19/32	191	15,00	2	000420115
5/8x5/8	201	15,90	2	000420116
11/16x11/16	212	17,00	2	000420117
3/4x3/4	233	18,10	2	000420119
13/16x13/16	254	21,90	2	000420121
7/8x7/8	264	22,60	2	000420122
15/16x15/16	285	26,50	2	000420124
1x1	296	27,00	2	000420125
1.1/16x1.1/16	317	31,00	2	000420127
1.1/8x1.1/8	338	33,50	2	000420129
1.1/4x1.1/4	370	41,00	2	000420132
1.5/16x1.5/16	391	67,00	1	000420133
1.3/8x1.3/8	412	77,00	1	000420135
1.7/16x1.7/16	412	79,50	1	000420136
1.1/2x1.1/2	433	83,50	1	000420138



	€	🔧	📦
42AS/B9N 1/4-5/16-3/8-7/16-1/2 9/16-5/8-11/16-3/4 2002/BV9	133,00	1	000420159
	12,70	1	020020030



	€	🔧	📦
42AS/13 1/4-5/16-3/8-7/16-1/2-9/16-5/8 11/16-3/4-13/16-7/8-15/16-1	219,00	1	000420163
42AS/16 1/4-5/16-3/8-7/16-1/2-9/16-5/8 11/16-3/4-13/16-7/8-15/16-1- 1.1/16-1.1/8-1.1/4	325,00	1	000420166
42AS/17 1/4-9/32-5/16-3/8-7/16-1/2- 9/16-19/32-5/8-11/16-3/4- 13/16-7/8-15/16-1-1.1/16-1.1/8	309,00	1	000420168

42MP

chaves mistas boca/luneta em cromado brilhante



DIN 3113 UNI-ISO 7738

🔧 mm	L mm	€	🔧	📦
6x6	95	13,80	5	000420606
7x7	105	13,90	5	000420607
8x8	116	14,00	5	000420608
9x9	127	14,10	5	000420609
10x10	137	14,20	5	000420610
11x11	148	14,50	5	000420611
12x12	158	14,60	5	000420612
13x13	169	14,80	5	000420613
14x14	180	16,00	5	000420614
15x15	190	17,30	5	000420615
16x16	201	18,30	5	000420616
17x17	212	19,10	5	000420617
18x18	222	20,40	5	000420618
19x19	233	21,10	5	000420619
20x20	243	24,10	3	000420620
21x21	254	25,50	3	000420621
22x22	264	26,00	3	000420622
24x24	285	30,00	3	000420624
27x27	317	35,50	3	000420627
30x30	349	44,00	3	000420630
32x32	370	46,00	3	000420632



	€	🔧	📦
42MP/B9N 6-7-8-10-11-13-14-17-19 mm	153,00	1	000420661
2002/BV9	12,70	1	020020030



	€	🔧	📦
42MP/S17 6-7-8-9-10-11-12-13-14-15 16-17-18-19-20-21-22 mm	302,00	1	000420652
42MP/S21 6-7-8-9-10-11-12-13-14 15-16-17-18-19-20-21-22 24-27-30-32 mm	456,00	1	000420653

42LMP

chaves mistas boca/luneta
série longa em cromado brilhante



Ø mm	L mm	€	🔧	📦
8x8	148	11,90	2	000420508
9x9	167	12,30	2	000420509
10x10	172	12,70	2	000420510
11x11	186	13,40	2	000420511
12x12	197	13,60	2	000420512
13x13	207	13,90	2	000420513
14x14	223	14,80	2	000420514
15x15	233	16,20	2	000420515
16x16	243	17,50	2	000420516
17x17	261	18,50	2	000420517
18x18	270	20,30	2	000420518
19x19	280	20,70	2	000420519
21x21	301	23,90	2	000420521
22x22	318	24,80	2	000420522
24x24	338	29,00	2	000420524
27x27	376	33,00	2	000420527
30x30	409	42,00	2	000420530
32x32	435	45,50	2	000420532



42LMP/S14 234,00 1 000420551

8-9-10-11-12-13-14
15-16-17-18-19-21-22 mm

42LMP/S18 383,00 1 000420552

8-9-10-11-12-13-14
15-16-17-18-19-21-22
24-27-30-32 mm

42SLIM

chaves mistas boca/luneta com espessura
reduzida



DIN 3113 UNI-ISO 7738

Ø mm	L mm	S1 mm	€	🔧	📦
8x8	116	3,4	10,20	5	000420408
10x10	137	3,8	11,10	5	000420410
11x11	148	3,8	11,70	5	000420411
12x12	158	4,2	11,90	5	000420412
13x13	169	4,4	12,00	5	000420413
14x14	180	4,6	13,80	5	000420414
15x15	190	4,7	15,00	5	000420415
16x16	201	4,7	15,50	5	000420416
17x17	212	5,1	16,10	5	000420417
18x18	222	5,1	17,30	5	000420418
19x19	233	5,6	17,60	5	000420419



42SLIM/B8NI 122,00 1 000420478

10-11-12-13-14-15-17-19 mm

42SLIM/B8NE 126,00 1 000420479

10-11-12-13-16-17-18-19 mm

2002/BV8 12,70 1 020020020



42SLIM/S11 152,00 1 000420471

8-10-11-12-13-14-15-
16-17-18-19 mm

45

chaves mistas boca/luneta
serviço pesado



DIN 3113 UNI-ISO 7738

Ø mm	L mm	€	🔧	📦
46x46	500	210,00	1	000450046
50x50	540	236,00	1	000450050
55x55	560	337,00	1	000450055
60x60	600	432,00	1	000450060
65x65	675	520,00	1	000450065
70x70	675	570,00	1	000450070
75x75	720	665,00	1	000450075
80x80	720	765,00	1	000450080

52

chaves de boca simples



UNI 6733 DIN 3114

Ø mm	L mm	€	🔧	📦
10	119	11,10	5	000520010
11	119	11,30	5	000520011
12	119	11,60	5	000520012
13	145	13,10	5	000520013
14	145	13,50	5	000520014
15	145	13,80	5	000520015
16	159	14,90	5	000520016
17	159	15,00	5	000520017
18	159	16,00	5	000520018
19	175	17,40	5	000520019
20	175	18,60	5	000520020
21	175	19,10	5	000520021
22	196	21,50	2	000520022
23	196	22,20	2	000520023
24	196	22,60	2	000520024
25	215	25,50	2	000520025
26	215	26,00	2	000520026
27	215	26,00	2	000520027
28	240	30,00	2	000520028
30	240	30,50	2	000520030
32	270	36,50	2	000520032
34	270	40,00	1	000520034
35	295	46,00	1	000520035
36	295	46,00	1	000520036
38	295	51,50	1	000520038
40	335	63,00	1	000520040
41	335	63,00	1	000520041
42	335	70,00	1	000520042
45	370	80,50	1	000520045
46	370	80,50	1	000520046
48	370	93,00	1	000520048
50	415	108,00	1	000520050
52	415	121,00	1	000520052
55	415	126,00	1	000520055
60	490	160,00	1	000520060
65	490	162,00	1	000520065
70	490	184,00	1	000520070

53

chaves de boca simples DIN 894



Ø mm	L mm	€	🔧	📦
36	317	34,00	1	000530036
38	320	37,00	1	000530038
41	342	43,50	1	000530041
46	396	53,00	1	000530046
50	412	83,00	1	000530050
55	457	95,00	1	000530055
60	492	118,00	1	000530060
65	528	139,00	1	000530065
70	572	161,00	1	000530070
75	608	202,00	1	000530075
80	645	247,00	1	000530080
85	690	300,00	1	000530085
90	690	356,00	1	000530090
95	847	496,00	1	000530095
100	847	525,00	1	000530100
105	1000	655,00	1	000530105
110	1000	710,00	1	000530110
115	1000	790,00	1	000530115
120	1000	895,00	1	000530120
125	1000	1.040,00	1	000530125
130	1000	1.110,00	1	000530130
135	1000	1.190,00	1	000530135

55

chaves de bocas



UNI-ISO 10102 DIN 3110

Ø mm	L mm	€	🔧	📦
4x5	101	5,40	5	000550003
5x5,5	101	6,10	5	000550006
5,5x7	120	6,10	5	000550009
• 6x7	120	4,75	5	000550012
7x8	140	6,10	5	000550018
• 8x9	140	4,85	5	000550021
8x10	140	6,10	5	000550024
• 10x11	155	5,20	5	000550030
10x12	155	7,00	5	000550033
10x13	170	7,70	5	000550035
• 12x13	170	5,90	5	000550042
12x14	170	7,90	5	000550045
13x14	185	8,80	5	000550047
13x17	189	9,40	5	000550051
• 14x15	185	7,30	5	000550054
14x17	189	10,10	5	000550057
• 16x17	202	8,40	5	000550060
17x19	220	11,30	2	000550063
• 18x19	220	9,90	2	000550066
19x22	236	12,80	2	000550069
• 20x22	236	11,30	2	000550075
• 21x23	245	12,00	2	000550078
22x24	245	13,90	2	000550081
• 24x26	262	14,30	2	000550087
24x27	262	15,50	2	000550090
• 25x28	272	16,20	2	000550096
• 27x29	284	18,40	2	000550099
27x30	284	21,20	2	000550102
27x32	297	23,00	2	000550105
• 30x32	297	20,40	2	000550108
32x36	325	63,00	1	000550114
34x36	325	63,00	1	000550117
35x38	375	69,50	1	000550120
36x41	375	72,50	1	000550123
41x46	425	83,00	1	000550129
46x50	475	103,00	1	000550132
50x55	500	120,00	1	000550135
55x60	500	126,00	1	000550138



55/B8N	€ 68,00	1	000550160
6x7-8x9-10x11-12x13 14x15-16x17-18x19 20x22 mm			
2002/BV8	12,70	1	020020020
55/B12N	138,00	1	000550164
6x7-8x9-10x11-12x13 14x15-16x17-18x19 20x22-21x23-24x26 25x28-30x32 mm			
2002/BV12	21,10	1	020020040



55/S8	€ 57,50	1	000550174
6x7-8x9-10x11-12x13 14x15-16x17-18x19 20x22 mm			
55/S12	121,00	1	000550178
6x7-8x9-10x11-12x13 14x15-16x17-18x19 20x22-21x23-24x26 25x28-30x32 mm			
55/S12X	122,00	1	000550179
6x7-8x9-10x11-12x13 14x15-16x17-18x19 20x22-21x23-24x27 25x28-30x32 mm			
55/S13	139,00	1	000550182
6x7-8x9-10x11-12x13 14x15-16x17-18x19 20x22-21x23-24x26 25x28-27x29-30x32 mm			



55/SP7

55/SP13

55/SP7	€ 48,50	1	000550167
6x7-8x9-10x11-12x13 14x15-16x17-18x19 mm			
42/SPV7	8,20	1	000420097
42: 8-10-11-13-14-17-19 mm			
55: 6x7-8x9-10x11-12x13			
14x15-16x17-18x19 mm			
55/SP13	172,00	1	000550186
6x7-8x9-10x11-12x13 14x15-16x17-18x19 20x22-21x23-24x26 25x28-27x29-30x32 mm			
55/SPV	33,50	1	000550190

55AS

chaves de bocas



mm	L mm	€	Q	PC
1/4x9/32	120	6,40	2	000550203
1/4x5/16	120	6,40	2	000550206
5/16x11/32	140	6,90	2	000550209
5/16x3/8	140	6,90	2	000550212
3/8x7/16	155	7,50	2	000550215
7/16x1/2	170	8,20	2	000550218
1/2x9/16	170	8,80	2	000550221
9/16x5/8	185	9,70	2	000550224
19/32x11/16	189	11,80	2	000550227
5/8x11/16	202	11,80	2	000550230
5/8x3/4	202	13,30	2	000550233
11/16x13/16	220	13,80	2	000550242
3/4x7/8	236	14,90	2	000550245
25/32x13/16	236	14,90	2	000550244
7/8x15/16	245	16,10	2	000550251
15/16x1	262	20,40	1	000550257
1x1.1/8	272	21,50	1	000550259
1.1/16x1.1/4	284	28,00	1	000550267
1.1/8x1.5/16	297	28,00	1	000550266
1.5/16x1.1/2	325	74,00	1	000550269
1.3/8x1.1/2	375	81,50	1	000550272
1.7/16x1.5/8	375	81,50	1	000550275



55AS/5	€ 49,50	1	000550290
5/16x11/32-3/8x7/16 1/2x9/16-5/8x11/16 3/4x7/8			
55AS/8	80,00	1	000550296
1/4x9/32-5/16x11/32-3/8x7/16- 1/2x9/16-9/16x5/8-5/8x11/16- 11/16x13/16-3/4x7/8			
55AS/12	164,00	1	000550298
1/4x9/32-5/16x11/32-3/8x7/16-1 /2x9/16-9/16x5/8-5/8x11/16- 11/16x13/16-25/32x13/16-3/4x7/8- 15/16x1-1x1.1/8-1.1/16x1.1/4			

55MP

chaves de bocas em cromado brilhante



UNH-SO 10102 DIN 3110

mm	L mm	€	Q	PC
6x7	120	6,40	2	000550603
8x9	140	6,80	2	000550606
10x11	155	7,60	2	000550609
12x13	170	8,30	2	000550612
14x15	185	9,90	2	000550615
16x17	202	11,60	2	000550618
18x19	220	13,40	2	000550621
20x22	236	15,30	2	000550624
21x23	245	16,70	2	000550627
24x26	262	19,90	1	000550630
25x28	272	21,00	1	000550633
27x29	284	24,30	1	000550636
30x32	297	27,50	1	000550639



55MP/S8	€ 79,00	1	000550650
6x7-8x9-10x11-12x13 14x15-16x17-18x19 20x22 mm			
55MP/S13	189,00	1	000550651
6x7-8x9-10x11-12x13 14x15-16x17-18x19 20x22-21x23-24x26 25x28-27x29-30x32 mm			
55MP/S12	164,00	1	000550653
6x7-8x9-10x11-12x13-14x15- 16x17-18x19-20x22-21x23-24x26- 25x28-30x32 mm			

58

chaves de boca, série pancada



DIN 133

mm	L mm	€	Q	PC
24	177	35,00	1	000580024
27	180	36,50	1	000580027
30	190	40,50	1	000580030
32	190	42,00	1	000580032
34	200	53,00	1	000580034
36	215	54,50	1	000580036
41	235	65,00	1	000580041
46	255	87,00	1	000580046
50	275	97,50	1	000580050
55	300	117,00	1	000580055
60	320	128,00	1	000580060
65	342	168,00	1	000580065
70	375	216,00	1	000580070
75	375	236,00	1	000580075
80	408	345,00	1	000580080
85	408	386,00	1	000580085
90	445	445,00	1	000580090
95	445	458,00	1	000580095
100	485	635,00	1	000580100
105	485	720,00	1	000580105
110	510	785,00	1	000580110
115	510	895,00	1	000580115
120	545	920,00	1	000580120
125	545	1.060,00	1	000580125
130	575	1.430,00	1	000580130
135	575	1.500,00	1	000580135
*140	575	1.620,00	1	000580140
*145	640	2.220,00	1	000580145
*150	640	2.310,00	1	000580150
*155	640	2.530,00	1	000580155
*160	640	2.770,00	1	000580160
*165	715	2.970,00	1	000580165
*170	715	4.050,00	1	000580170
*175	715	4.280,00	1	000580175
*180	715	4.640,00	1	000580180
*185	715	4.770,00	1	000580185
*190	800	5.250,00	1	000580190
*195	800	5.500,00	1	000580195
*200	800	5.800,00	1	000580200
*210	800	7.200,00	1	000580210
*220	800	9.300,00	1	000580220
*230	800	11.400,00	1	000580230

73

chaves de bocas
de pequenas dimensões



UNI 6737

mm	L mm	€		
4x4	78	9,80	5	000730040
4,5x4,5	78	9,80	5	000730045
5x5	78	9,80	5	000730050
5,5x5,5	86	10,60	5	000730055
6x6	86	10,60	5	000730060
7x7	86	10,60	5	000730070
8x8	97	11,10	5	000730080
9x9	97	11,10	5	000730090
10x10	108	11,90	5	000730100
11x11	108	11,90	5	000730110
12x12	124	13,80	5	000730120
13x13	124	13,80	5	000730130
14x14	124	13,80	5	000730140



	€		
73/B13N 4-4,5-5-5,5-6-7-8-9 10-11-12-13-14 mm	161,00	1	000730202
2002/BV13	12,70	1	020020050



	€		
73/S13 4-4,5-5-5,5-6-7-8-9 10-11-12-13-14 mm	148,00	1	000730210



78

chaves de luneta de 12 faces
série pancada



DIN 7444

mm	L mm	€		
24	162	35,50	1	000780024
27	180	41,50	1	000780027
30	190	49,00	1	000780030
32	190	52,50	1	000780032
34	200	60,00	1	000780034
36	205	65,00	1	000780036
41	225	84,00	1	000780041
46	235	94,00	1	000780046
50	250	112,00	1	000780050
55	265	127,00	1	000780055
60	275	155,00	1	000780060
65	295	196,00	1	000780065
70	325	197,00	1	000780070
75	325	234,00	1	000780075
80	350	358,00	1	000780080
85	350	392,00	1	000780085
90	390	479,00	1	000780090
95	390	555,00	1	000780095
100	420	615,00	1	000780100
105	420	725,00	1	000780105
110	450	790,00	1	000780110
115	450	900,00	1	000780115
120	490	1.240,00	1	000780120
125	480	1.670,00	1	000780125
130	520	1.930,00	1	000780130
135	520	2.070,00	1	000780135
*140	520	2.350,00	1	000780140
*145	580	2.960,00	1	000780145
*150	580	3.100,00	1	000780150
*155	580	3.570,00	1	000780155
*160	650	3.660,00	1	000780160
*165	650	3.890,00	1	000780165
*170	650	4.660,00	1	000780170
*175	650	5.050,00	1	000780175
*180	650	5.550,00	1	000780180
*185	695	5.750,00	1	000780185
*190	695	6.250,00	1	000780190
*195	695	6.250,00	1	000780195
*200	695	6.350,00	1	000780200
*210	740	6.800,00	1	000780210
*215	740	7.600,00	1	000780215
*220	740	8.350,00	1	000780220
*230	740	10.400,00	1	000780230

78AS

chave de luneta de pancada



mm	L mm	€		
*1.1/16	180	50,50	1	000780327
*1.1/8	190	50,50	1	000780329
*1.3/16	190	50,50	1	000780330
*1.1/4	197	54,50	1	000780332
*1.5/16	197	56,50	1	000780333
*1.3/8	223	60,00	1	000780335
*1.7/16	223	72,50	1	000780336
*1.1/2	223	75,00	1	000780338
*1.5/8	223	85,50	1	000780341
*1.11/16	225	89,00	1	000780343
*1.13/16	240	98,50	1	000780346
*1.7/8	250	99,50	1	000780348
*2	250	114,00	1	000780350
*2.1/16	250	118,00	1	000780352
*2.3/16	275	124,00	1	000780355
*2.3/8	270	168,00	1	000780360
*2.9/16	302	186,00	1	000780365

"	L mm	€		
*2.3/4	350	202,00	1	000780370
*2.15/16	350	233,00	1	000780375
*3.1/8	354	385,00	1	000780380

80

chaves de caixa articuladas
com 12 faces



mm	L mm	€		
6x7	170	39,50	3	000800006
8x9	176	40,50	3	000800008
8x10	179	40,50	3	000800009
10x11	182	42,50	3	000800010
12x13	228	48,50	3	000800012
14x15	232	49,00	3	000800014
13x17	231	52,50	3	000800015
16x17	234	52,50	2	000800016
18x19	285	65,00	2	000800018
19x22	287	68,50	2	000800019
20x22	289	68,50	2	000800020
21x23	289	69,50	2	000800021
24x27	405	114,00	2	000800024
30x32	413	121,00	2	000800030



	€		
80/S8 6x7-8x9-10x11-12x13-14x15 16x17-18x19-20x22 mm	405,00	1	000800051
80/S11 6x7-8x9-10x11-12x13 14x15-16x17-18x19-20x22 21x23-24x27-30x32 mm	710,00	1	000800056

83

chaves curvas de lunetas para motores
de arranque



ISO 3318

mm	L mm	€		
8x10	126	20,00	3	000830008
10x12	137	21,00	3	000830010
11x13	138	21,50	3	000830011
14x17	183	27,00	3	000830014
15x17	184	30,50	2	000830015
16x18	196	33,50	2	000830016
19x22	231	42,50	2	000830019



	€		
83/S3 11x13-14x17-19x22 mm	91,50	1	000830081
83/S5 10x12-11x13-15x17 16x18-19x22 mm	149,00	1	000830085

83AS

chaves curvas de lunetas para motores de arranque



mm	L mm	€	U	PC
7/16x1/2	138	25,50	2	000830111
9/16x5/8	183	30,50	2	000830114
3/4x7/8	230	48,00	2	000830119



mm	L mm	€	U	PC
83AS/3		105,00	1	000830181
7/16x1/2-9/16x5/8-3/4x7/8				

88

chaves de luneta duplas direitas, série extralonga



mm	L mm	€	U	PC
8x10	235	22,30	2	000880008
12x14	330	26,50	2	000880012
13x15	330	26,50	2	000880013
16x18	405	36,50	2	000880016
17x19	405	36,50	2	000880017
21x23	435	42,00	2	000880021
22x24	435	42,00	2	000880022



mm	L mm	€	U	PC
88/S7		232,00	1	000880107
8x10-12x14-13x15-16x18-17x19-21x23-22x24 mm				

90

chaves de lunetas com curvatura profunda



DIN 838 ISO 10104

mm	L mm	€	U	PC
6x7	165	11,10	5	000900006
8x9	180	11,80	5	000900012
8x10	180	13,90	5	000900015
10x11	195	13,00	5	000900018
10x12	195	14,10	5	000900021
11x13	215	15,50	5	000900024
12x13	215	14,20	5	000900027
12x14	215	16,30	5	000900030
14x15	230	15,50	5	000900033
14x17	250	19,20	5	000900036
16x17	250	17,70	5	000900039
17x19	265	22,80	5	000900042
18x19	265	20,70	5	000900045
19x22	285	25,50	3	000900048
20x22	285	23,80	3	000900051
21x23	305	27,00	2	000900057
22x24	305	29,00	2	000900060
24x26	325	30,00	2	000900063
24x27	325	33,50	2	000900067
25x28	340	36,00	2	000900070
27x29	355	38,50	2	000900073
27x30	355	42,00	2	000900076
27x32	375	47,00	2	000900078
30x32	375	43,50	2	000900080
32x36	395	65,00	1	000900088
34x36	415	77,00	1	000900089
35x38	415	78,00	1	000900091
36x41	435	89,00	1	000900094
41x46	460	128,00	1	000900097
46x50	500	169,00	1	000900100



mm	L mm	€	U	PC
90/B8N		141,00	1	000900156
6x7-8x9-10x11-12x13-14x15-16x17-18x19-20x22 mm				
2002/BV8		12,70	1	020020020



mm	L mm	€	U	PC
90/S8		128,00	1	000900162
6x7-8x9-10x11-12x13-14x15-16x17-18x19-20x22-21x23-24x26-25x28-30x32 mm				
90/S12		264,00	1	000900166
6x7-8x9-10x11-12x13-14x15-16x17-18x19-20x22-21x23-24x26-25x28-30x32 mm				
90/S12X		268,00	1	000900167
6x7-8x9-10x11-12x13-14x15-16x17-18x19-20x22-21x23-24x27-25x28-30x32 mm				
90/S13		302,00	1	000900170
6x7-8x9-10x11-12x13-14x15-16x17-18x19-20x22-21x23-24x26-25x28-27x29-30x32 mm				



mm	L mm	€	U	PC
90/SP13		343,00	1	000900174
6x7-8x9-10x11-12x13-14x15-16x17-18x19-20x22-21x23-24x26-25x28-27x29-30x32 mm				
55/SPV		33,50	1	000550190

90AS

chaves de lunetas com curvatura profunda



mm	L mm	€	U	PC
1/4x5/16	165	12,70	2	000900203
5/16x11/32	180	13,70	2	000900206
5/16x3/8	180	14,00	2	000900209
3/8x7/16	195	14,20	2	000900212
7/16x1/2	215	16,00	2	000900215
1/2x9/16	230	18,30	2	000900218
9/16x5/8	230	18,30	2	000900221
19/32x11/16	250	19,90	2	000900222
5/8x11/16	250	20,70	2	000900224
5/8x3/4	265	24,40	2	000900227
11/16x3/4	265	24,40	1	000900230
11/16x13/16	265	24,40	1	000900233
3/4x25/32	265	28,50	1	000900235
3/4x7/8	285	28,50	1	000900237
13/16x7/8	285	29,00	1	000900240
7/8x15/16	305	29,00	1	000900243
15/16x1	325	35,00	1	000900252
1.1/16x1.1/4	375	50,50	1	000900258
1.1/8x1.5/16	375	51,00	1	000900261



mm	L mm	€	U	PC
90AS/8		168,00	1	000900298
1/4x5/16-5/16x11/32-3/8x7/16-1/2x9/16-5/8x11/16-11/16x3/4-13/16x7/8-15/16x1				
90AS/10		269,00	1	000900300
1/4x5/16-5/16x11/32-3/8x7/16-1/2x9/16-5/8x11/16-11/16x3/4-13/16x7/8-15/16x1-1.1/16x1.1/4-1.1/8x1.5/16				

Beta

Beta

91

chaves de luneta inclinada para serviços pesados



Ø mm	Ø mm	€	🔧	📦
24	38	63,50	1	000910024
27	41	65,50	1	000910027
30	48	70,50	1	000910030
32	49	76,00	1	000910032
36	54	87,00	1	000910036
41	62	104,00	1	000910041
46	69	121,00	1	000910046
50	76	138,00	1	000910050
55	81	154,00	1	000910055
60	90	192,00	1	000910060
65	98	215,00	1	000910065
70	105	242,00	1	000910070
75	110	277,00	1	000910075
80	125	318,00	1	000910080
85	125	332,00	1	000910085
90	140	595,00	1	000910090
95	140	650,00	1	000910095
100	143	690,00	1	000910100
105	146	770,00	1	000910105

92

cabo tubular para a chave ref. 91



	L mm	91 mm	Ø mm	€	🔧	📦
92/1	460	24÷30	19	38,00	1	000920010
92/2	610	32÷41	22	58,50	1	000920020
92/3	760	46÷55	25	83,00	1	000920030
92/4	860	60÷105	30	111,00	1	000920040

93

chave de lunetas com curvatura profunda especial para andaimes



Ø mm	L mm	€	🔧	📦
21x22	310	45,50	3	000930021

93C

roquete de dupla face, com curvatura, para parafusos de andaimes



Ø mm	L mm	€	🔧	📦
17x19	310	51,50	1	000930117
19x22	310	55,50	1	000930119
19x24	365	68,00	1	000930120
21x22	310	62,00	1	000930121
36x38	445	104,00	1	000930136

94

chaves de lunetas abertas



DIN 3118

Ø mm	L mm	€	🔧	📦
8x10	140	19,20	2	000940008
9x11	153	20,00	2	000940009
10x11	153	21,10	2	000940010
11x13	175	21,70	2	000940011
12x14	175	23,00	2	000940012
13x15	175	23,00	2	000940013
14x15	175	27,00	2	000940014
14x17	195	28,00	2	000940015
17x19	212	28,50	2	000940017
19x22	228	30,00	2	000940019
22x24	242	37,00	2	000940022
24x27	260	40,50	2	000940024
30x32	300	52,50	2	000940030
36x41	320	89,50	1	000940036



	€	🔧	📦
94/S6	144,00	1	000940050
8x10-10x11-11x13-12x14 17x19-19x22 mm			
94/S10	294,00	1	000940052
8x10-9x11-10x11-11x13 12x14-17x19-19x22 22x24-24x27-30x32 mm			

95

chaves de lunetas direitas

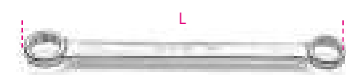

DIN 837 ISO 10103

Ø mm	L mm	€	🔧	📦
6x7	120	12,60	3	000950161
8x9	135	13,60	3	000950162
10x11	150	15,30	3	000950163
12x13	165	16,60	3	000950164
14x15	185	17,50	3	000950165
16x17	210	18,60	3	000950166
17x19	225	21,50	3	000950167
18x19	225	21,50	2	000950168
20x22	240	24,40	2	000950169
21x23	255	25,50	2	000950170
24x26	270	27,00	2	000950171
25x28	285	32,50	2	000950172
27x29	315	33,50	2	000950173
30x32	335	37,50	2	000950174



	€	🔧	📦
95/S8	140,00	1	000950177
6x7-8x9-10x11-12x13 14x15-16x17-18x19 20x22 mm			
95/S13	296,00	1	000950179
6x7-8x9-10x11-12x13 14x15-16x17-18x19 20x22-21x23-24x26 25x28-27x29-30x32 mm			

95FTX

chaves de lunetas direitas, para parafusos com perfil Torx®



Ø mm	L mm	€	🔧	📦
E6xE8	115	13,00	2	000950306
E10xE12	143	13,70	2	000950310
E14xE18	177	15,50	2	000950314
E20xE24	224	21,10	2	000950320



	€	🔧	📦
95FTX/S4	63,50	1	000950325
E6xE8-E10xE12 E14xE18-E20xE24			



CHAVES MACHO SEXTAVADAS

As chaves macho sextavadas da Beta são concebidas para trabalhos longos e precisos.

A ampla gama cobre todos os requisitos de utilização: extracurtas, curtas, longas, extralongas, com ponta de bola, em T, ou com punho de aperto elevado, estas chaves incluem-se nos produtos que mais se destacam na gama Beta, sem rival à altura no mercado.

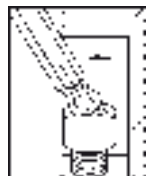

As chaves ponta de bola permitem trabalhar a um ângulo até 30° do eixo do parafuso.

As chaves são fornecidas numa bolsa para rápida identificação do tamanho desejado. Quando fechada, garante que as chaves estão protegidas e não se perdem, mesmo as de menor dimensão.

A versão colorida combina as características excepcionais das chaves standard com a identificação imediata do tamanho desejado, para facilitar o trabalho diário.



96/B8 2-2,5-3-4-5-6-8-10 mm	€ 20,00	5	000960386
96/B10 1,5-2-2,5-3-4-5-6-8-10-12 mm	€ 28,50	5	000960380
96N/BV	€ 2,16	1	000960651



96/SC9 1,5-2-2,5-3-4-5-6-8-10 mm	€ 23,80	1	000960374
96/SCV	€ 4,85	1	000960985



96/SC12 2-2,5-3-3,5-4-4,5-5-6-7-8-9-10 mm	€ 34,00	1	000960395
96/SCV12	€ 5,80	1	000960975

96

chaves macho hexagonal cromadas



ISO 2936

mm	L mm	L1 mm	€	U	000960000
0,9	35	8	1,11	20	000960013
1,3	39	10	1,11	20	000960014
1,5	45	15	1,11	20	000960015
2	50	17	1,17	20	000960020
2,5	57	20	1,17	20	000960025
3	64	22	1,38	20	000960030
3,5	68	25	1,64	20	000960035
4	72	28	1,72	20	000960040
4,5	78	30	1,77	20	000960045
5	83	32	1,84	20	000960050
5,5	88	35	2,32	20	000960055
6	94	37	2,32	20	000960060
7	99	40	2,87	10	000960070
8	105	43	3,35	10	000960080
9	111	46	3,95	10	000960090
10	119	49	4,75	10	000960100
11	126	52	6,00	10	000960110
12	134	56	7,20	10	000960120
13	142	62	9,20	10	000960130
14	151	69	10,70	10	000960140
16	165	75	15,70	5	000960160
17	174	79	16,50	5	000960170
19	196	88	23,00	5	000960190
22	216	100	36,00	3	000960220
24	242	112	47,50	1	000960240
27	271	125	63,00	1	000960270
30	309	140	84,50	1	000960300
32	341	155	112,00	1	000960312
36	385	174	161,00	1	000960316



96/ST6 2,5-3-4-5-6-8 mm	€ 16,10	3	000960370
-----------------------------------	---------	---	-----------



96/BGS7 1,5-2-2,5-3-4-5-6 mm	€ 35,50	1	000960367
--	---------	---	-----------



96/BG7 2,5-3-4-5-6-8-10 mm	€ 37,50	1	000960368
--------------------------------------	---------	---	-----------

96N

chaves macho hexagonal, brunidas



ISO 2936

mm	L mm	L1 mm	€	U	000960000
0,9	32	10	0,55	20	000960409
1,3	44	12	0,55	20	000960413
1,5	46	15	0,58	20	000960415
2	51	17	0,62	20	000960420
2,5	57	20	0,64	20	000960425
3	64	22	0,71	20	000960430
3,5	68	25	0,86	20	000960435
4	72	28	0,98	20	000960440
4,5	78	30	1,06	20	000960445
5	83	32	1,12	20	000960450
6	94	37	1,40	20	000960460
7	99	40	1,87	10	000960470
8	105	43	2,22	10	000960480
9	111	46	2,89	10	000960490
10	119	49	3,45	10	000960500
11	126	52	4,25	10	000960510
12	134	56	5,20	10	000960520
13	142	62	7,00	10	000960530
14	151	69	7,80	10	000960540
16	165	72	11,80	5	000960560
17	174	79	12,70	5	000960570
19	194	88	17,20	5	000960590
22	216	99	31,50	1	000960592
24	242	111	41,50	1	000960594



96N/ST6
2,5-3-4-5-6-8 mm

€ 11,30 3 000960640



96N/G7
2,5-3-4-5-6-8-10 mm

€ 29,50 3 000960645

96N/G7A
1,5-2-2,5-3-4-5-6 mm

€ 20,70 3 000960643



96N/B10
1,5-2-2,5-3-4-5-6
8-10-12 mm

€ 19,10 5 000960650

96N/BV
€ 2,16 1 000960651



96N/SC9
1,5-2-2,5-3-4-5-6-8-10 mm

€ 16,60 1 000960644

96N/SCV
€ 4,85 1 000960986



96N/SC12
2-2,5-3-3,5-4-4,5-5
6-7-8-9-10 mm

€ 23,70 1 000960661

96N/SCV12
€ 5,80 1 000960976

96C/AS

chaves de aperto sextavadas,
cromadas



"	L mm	L1 mm	g	€	🔧	📄
1/16	46	16	1,01	1,95	20	000961702
3/32	53	19	2,70	2,70	20	000961706
1/8	60	22	5,33	2,84	20	000961710
5/32	67	25	9,33	3,30	20	000961714
3/16	74	28	14,87	3,75	20	000961716
7/32	81	32	22,00	4,25	20	000961718
1/4	89	35	31,40	4,75	20	000961720
5/16	103	40	56,16	5,30	10	000961724
3/8	117	45	91,31	6,60	10	000961728



96C-AS/SC9
1/16-3/32-1/8-5/32-3/16-
7/32-1/4-5/16-3/8

€ 40,50 1 000961753

96AS

chaves macho hexagonal, brunidas



"	L mm	L1 mm	€	🔧	📄
1/30 (0,035")	44	14	0,99	20	000960698
1/20 (0,050")	44	15	0,99	20	000960701
1/16	46	16	1,06	20	000960702
5/64	50	18	1,31	20	000960704
3/32	53	19	1,51	20	000960706
7/64	57	21	1,55	20	000960708
1/8	60	22	1,58	20	000960710
9/64	64	24	1,88	20	000960712
5/32	68	25	1,95	20	000960714
3/16	75	29	2,16	20	000960716
7/32	82	32	2,43	20	000960718
1/4	89	35	2,84	20	000960720
5/16	103	40	3,55	10	000960724
3/8	117	44	4,30	10	000960728
7/16	132	49	6,30	10	000960730
1/2	149	54	8,00	10	000960732
9/16	151	69	13,00	2	000960734



96AS/SC9
1/16-3/32-1/8-5/32-3/16
7/32-1/4-5/16-3/8

€ 26,50 1 000960743

96AS/SCV
€ 4,85 1 000960744



96AS/T7
3/32-1/8-5/32
3/16-7/32-1/4-5/16

€ 21,30 3 000960740



96AS/BG7
3/32-1/8-5/32-3/16
1/4-5/16-3/8

€ 37,50 1 000960747



96AS/B11
1/20-1/16-5/64-3/32
1/8-5/32-3/16-7/32
1/4-5/16-3/8

€ 26,00 1 000960749

96N/BV
€ 2,16 1 000960651



96LC

chaves macho hexagonal
série longa, cromadas



ISO 2936

mm	L mm	L1 mm	€	🔧	📄
2	101	17	2,11	20	000960320
2,5	113	20	2,25	20	000960321
3	127	22	2,46	20	000960322
3,5	138	25	2,51	20	000960323
4	142	28	2,73	20	000960324
4,5	154	28	3,20	20	000960325
5	163	32	3,50	20	000960326
6	184	37	3,75	20	000960327
7	194	40	4,30	10	000960328
8	205	43	5,30	10	000960329
9	216	46	5,90	10	000960330
10	231	49	7,60	10	000960331
12	259	56	9,40	10	000960332





96LC/SC8	€ 34,50	1	000960334
2-2,5-3-4-5-6-8-10 mm			
96LC/SCV	4,85	1	000960983



96LC/SC12	€ 51,50	1	000960337
2-2,5-3-3,5-4-4,5-5-6-7-8-9-10 mm			
96LC/SCV12	5,80	1	000960977

96L

chaves macho hexagonal série longa, brunidas



ISO 2936

mm	L mm	L1 mm	€		
2	99	15	1,49	20	000960820
2,5	110	17	1,54	20	000960825
3	124	19	1,75	20	000960830
3,5	135	21	1,88	20	000960835
4	138	24	2,09	20	000960840
4,5	150	25	2,43	20	000960845
5	158	27	2,56	20	000960850
6	178	31	2,89	20	000960860
7	187	33	3,70	10	000960870
8	197	35	4,70	10	000960880
9	207	37	5,30	10	000960890
10	221	39	7,00	10	000960900
12	247	44	9,00	10	000960920



96L/SC8	€ 29,00	1	000960924
2-2,5-3-3,5-4-4,5-5-6-8-9-10 mm			
96L/SCV	4,85	1	000960987



96L/SC12	€ 43,00	1	000960929
2-2,5-3-3,5-4-4,5-5-6-7-8-9-10 mm			
96L/SCV12	5,80	1	000960978

96BP-CL

chaves de caixa sextavadas, macho, com ponta esférica, cromadas, coloridas



mm	L mm	L1 mm	€		
1,5	91	16	3,30	5	000961600
2	102	17	3,70	5	000961601
2,5	113	21	4,10	5	000961602
3	128	23	4,55	5	000961603
4	143	28	5,10	5	000961604
5	163	33	5,60	5	000961605
6	185	37	7,10	5	000961606
8	206	43	9,60	2	000961608
10	231	50	12,70	2	000961610



96BP-CL/SC9	€ 60,50	1	000961619
1,5-2-2,5-3-4-5-6-8-10 mm			
96BP-CL/SCV	4,85	1	000961629

96BPC

chaves macho hexagonal com uma extremidade esférica cromadas

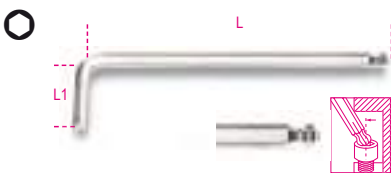

mm	L mm	L1 mm	€		
1,5	79	13	2,49	10	000960340
2	84	15	2,62	10	000960341
2,5	89	17	2,75	10	000960342
3	99	19	2,95	10	000960343
4	108	24	3,35	10	000960344
5	126	27	4,10	10	000960345
6	148	31	5,90	10	000960346
7	157	33	7,70	5	000960353
8	168	35	7,80	5	000960347
10	187	39	12,70	5	000960348
12	220	55	16,30	5	000960352



96BPC/SC9	€ 49,50	1	000960354
1,5-2-2,5-3-4-5-6-8-10 mm			
96BPC/SCV	4,85	1	000960984

96BP

chaves macho hexagonal com uma extremidade esférica, brunidas



mm	L mm	L1 mm	€		
1,5	79	13	1,88	10	000960960
2	84	15	2,01	10	000960961
2,5	89	17	2,09	10	000960962
3	99	19	2,16	10	000960963
4	108	24	2,49	10	000960965
5	126	27	3,30	10	000960967
6	148	31	4,75	10	000960968
8	168	35	6,90	5	000960970
10	187	39	11,60	5	000960972
12	220	55	17,30	5	000960973



96BP/SC9	€ 42,00	1	000960974
1,5-2-2,5-3-4-5-6-8-10 mm			
96BP/SCV	4,85	1	000960988

96LBP

chave sextavada ponta de bola, modelo extra longo



mm	L mm	L1 mm	€		
1,5	90	15	2,89	5	000961340
2	100	17	3,05	5	000961341
2,5	112	20	3,25	5	000961342
3	127	22	3,35	5	000961343
4	144	27	4,15	5	000961344
5	163	32	4,95	5	000961345
6	184	37	6,90	5	000961346
8	204	44	9,50	2	000961348
10	230	49	15,10	2	000961350



96LBP/SC9	€ 58,00	1	000961354
1,5-2-2,5-3-4-5-6-8-10 mm			
96LBP/SCV	4,85	1	000961984

96BP/AS

chaves macho hexagonal
com uma extremidade esférica, bruidas



"	L mm	L1 mm	€		
3/32	89	17	2,28	10	000960989
1/8	98	18	2,43	10	000960990
5/32	108	24	2,89	10	000960991
3/16	126	26	3,30	10	000960992
7/32	139	28	4,80	10	000960993
1/4	152	31	5,30	10	000960994
5/16	168	34	7,00	5	000960995
3/8	190	39	11,50	5	000960996



	€		
96BP-AS/SC9 1/16-3/32-1/8-5/32-3/16 7/32-1/4-5/16-3/8	45,50	1	000961000
96BP-AS/SCV	4,85	1	000961001



	€		
96BP-AS/8 3/32-1/8-5/32-3/16-7/32 1/4-5/16-3/8	41,50	1	000960997
96BP-AS/BV	2,16	1	000960998

96BPA

chave sextavada ponta de bola, 110°,
modelo extra curto



mm	L mm	L1 mm	€		
1,5	71	9	2,70	5	000961960
2	86	11	2,84	5	000961961
2,5	96	13	2,95	5	000961962
3	104	15	3,25	5	000961963
4	116	17	3,85	5	000961964
5	132	19	4,65	5	000961965
6	155	21	6,80	5	000961966
8	176	24	8,90	2	000961968
10	200	27	13,90	2	000961970



	€		
96BPA/SC9 1,5-2-2,5-3-4-5-6-8-10 mm	54,50	1	000961974
96BPA/SCV	4,85	1	000961988

96T

CHAVES MACHO SEXTAVADAS

com punho de aperto elevado

*Rapidez e facilidade
de utilização*

O punho de pequenas dimensões é
perfeitamente equilibrado, o que lhe
permite rodar rapidamente na palma da
mão.

O formato ergonómico permite a aplicação
de apertos extremamente elevados.

As extremidades sextavadas foram
concebidas para transmitir o máximo
aperto possível ao parafuso.

O eixo redondo possui uma estrutura
homogénea em comparação com o
eixo sextavado, o que proporciona força
adicional.



O eixo atravessa
o punho

96T

chaves macho sextavadas com punho

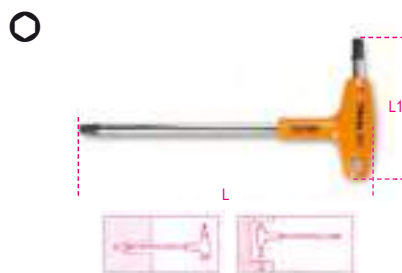

mm	L mm	L1 mm	€		
2	139	52	13,00	5	000960934
2,5	153	55	13,00	5	000960935
3	153	55	13,70	5	000960936
3,5	179	70	14,10	5	000960937
4	179	70	14,10	5	000960938
4,5	200	84	14,40	5	000960939
5	200	84	14,40	5	000960940
6	221	103	16,50	5	000960941
7	236	106	18,10	3	000960942
8	255	117	21,10	3	000960943
10	285	132	24,20	3	000960945



	€		
96T/S5P 2,5-3-4-5-6	71,50	1	000960946
96T/S6 2-2,5-3-4-5-6 mm	84,50	1	000960952
96T/S8 2-2,5-3-4-5-6-8-10 mm	130,00	1	000960933
96T/S11 2-2,5-3,3,5-4-4,5-5-6-7-8-10 mm	177,00	1	000960951



	€		
96T/SP11 2-2,5-3-3,5-4-4,5-5 6-7-8-10 mm	220,00	1	000960957
96T/SPV 96T/S11 97TTX/S11	49,00	1	000960958

96T/AS

chaves macho hexagonal com punho



"	L mm	L1 mm	€		
3/32	153	55	16,20	2	000960669
7/64	153	55	16,20	2	000960670
1/8	179	70	16,40	2	000960671
9/64	179	70	17,20	2	000960672
5/32	200	84	17,20	2	000960673
3/16	200	84	17,20	2	000960674
7/32	221	103	19,10	2	000960675
1/4	236	106	21,30	2	000960676
5/16	255	117	24,20	2	000960678
3/8	285	132	29,00	2	000960680



	€		
96T/AS8 3/32-7/64-1/8-5/32-3/16- 1/4-5/16-3/8	157,00	1	000960682
96T/AS10 3/32-7/64-1/8-9/64-5/32 3/16-7/32-1/4-5/16-3/8	194,00	1	000960683

96TBP

chaves macho hexagonal com punho e extremidade esférica

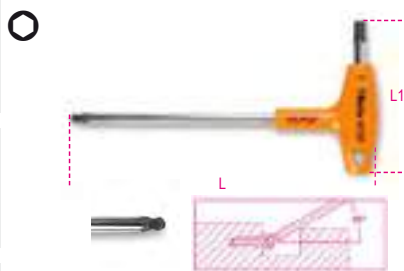

mm	L mm	L1 mm	€	U	IT
2,5	153	55	13,70	3	000960685
3	153	55	14,30	3	000960686
4	179	70	15,10	3	000960687
5	200	84	15,70	3	000960688
6	221	103	17,20	3	000960689
8	255	117	22,70	2	000960690
10	285	132	24,20	2	000960692



96TBP/S6
2,5-3-4-5-6-8 mm

€ 99,00 U 1 IT 000960694

97TX

chaves macho para parafusos com cabeça Torx®



mm	L mm	L1 mm	€	U	IT
T6	42	16	7,30	5	000970006
T7	48	16	7,30	5	000970007
T8	48	16	7,30	5	000970008
T9	48	16	8,00	5	000970009
T10	51	17	8,20	5	000970010
T15	54	18	8,20	5	000970015
T20	57	19	8,70	5	000970020
T25	60	20	8,90	5	000970025
T27	64	21	9,80	5	000970027
T30	70	24	9,80	5	000970030
T40	76	26	10,90	5	000970040
T45	83	29	13,00	5	000970045
T50	95	32	14,90	5	000970050
T55	108	35	18,90	5	000970055
T60	120	38	25,00	5	000970060



97TX/ST8
T9-T10-T15-T20-T25
T27-T30-T40

€ 78,00 U 1 IT 000970640



97TX/G8
T9-T10-T15-T20-T25
T27-T30-T40

€ 61,50 U 1 IT 000970645



97TX/BG8
T9-T10-T15-T20-T25-T27-T30-T40

€ 48,50 U 1 IT 000970368



97TX/SC8
T9-T10-T15-T20-T25
T27-T30-T40

€ 77,00 U 1 IT 000970064

97TX/SCV 4,85 1 000970985



97TX/B13
T6-T7-T8-T9-T10-T15-T20
T25-T27-T30-T40-T45-T50

€ 124,00 U 1 IT 000970650

96N/BV 2,16 1 000960651

97BTX

chaves macho com uma extremidade esférica, para parafusos com cabeça Torx®



mm	L mm	L1 mm	€	U	IT
T9	62	16	9,30	5	000970109
T10	71	17	9,30	5	000970110
T15	81	18	9,30	5	000970115
T20	92	19	10,00	5	000970120
T25	94	20	10,60	5	000970125
T27	105	21	11,30	5	000970127
T30	114	24	11,40	5	000970130
T40	129	26	13,10	5	000970140
T45	133	28	15,40	5	000970145



97BTX/SC8 89,00 1 000970164
T9-T10-T15-T20-T25-T27-T30-T40

97BTX/SCV 4,85 1 000970983



97BTX/B8 86,50 1 000970159
T9-T10-T15-T20-T25
T27-T30-T40

96N/BV 2,16 1 000960651

97BTX-C

conjunto de chaves macho com uma extremidade esférica, para parafusos com cabeça Torx®, coloridas



mm	L mm	L1 mm	€	U	IT
T9	80	16	10,20	5	000971609
T10	86	17	10,20	5	000971610
T15	90	18	10,20	5	000971615
T20	95	19	11,20	5	000971620
T25	100	20	11,90	5	000971625
T27	105	21	12,60	5	000971627
T30	114	24	13,00	5	000971630
T40	124	26	14,30	5	000971640



97BTX-C/SC8 98,50 1 000971658
T9-T10-T15-T20-T25-T27-T30-T40

97BTX-C/SCV 4,85 1 000971659



97BTKL

chaves macho com uma extremidade esférica, para parafusos com cabeça Torx®, modelo longo

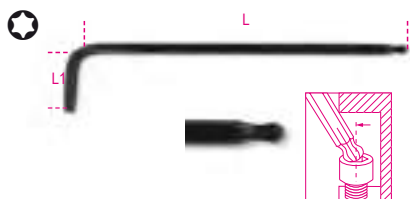

	L mm	L1 mm	€		
T9	80	15	9,80	3	000970309
T10	86	17	9,80	3	000970310
T15	100	18	9,80	3	000970315
T20	110	19	11,20	3	000970320
T25	126	20	12,30	3	000970325
T27	140	24	13,80	3	000970327
T30	160	28	14,30	3	000970330
T40	176	32	17,10	3	000970340



97BTKL/SC8 T9-T10-T15-T20- T25-T27-T30-T40	€ 103,00	1	000970364
97BTKL/SCV	4,85	1	000970982

97RTX

chaves macho para parafusos com cabeça Tamper Resistant Torx®



	L mm	L1 mm	€		
T6	40	15	8,80	5	000970206
T7	45	15	8,80	5	000970207
T8	50	16	8,80	5	000970208
T9	56	16	8,80	5	000970209
T10	62	17	8,80	5	000970210
T15	72	17	8,80	5	000970215
T20	83	18	9,00	5	000970220
T25	90	18	9,30	5	000970225
T27	100	20	10,50	5	000970227
T30	105	24	10,60	5	000970230
T40	112	26	11,60	5	000970240
T45	118	26	13,70	5	000970245
T50	122	28	17,60	3	000970250
T55	128	30	20,20	3	000970255



97RTX/SC8 T9-T10-T15-T20-T25- T27-T30-T40	€ 82,00	1	000970263
97RTX/SCV	4,85	1	000970984



97RTX/B8 T9-T10-T15-T20-T25- T27-T30-T40	€ 79,50	1	000970260
96N/BV	2,16	1	000960651

97BRTXL/SC8

jogo de 8 chaves sextavadas macho com ponta de bola, modelo longo, para parafusos de perfil Tamper Resistant Torx®



97BRTXL/SC8 T9-T10-T15-T20- T25-T27-T30-T40	€ 104,00	1	000970464
97BRTXL/SCV	4,85	1	000970986

97TTX

chaves duplas macho com punho para parafusos com cabeça Torx®



	L mm	L1 mm	€		
T6	130	52	13,50	3	000970706
T7	130	52	13,50	3	000970707
T8	139	52	13,60	3	000970708
T9	139	52	13,60	3	000970709
T10	179	70	13,90	3	000970710
T15	179	70	15,00	3	000970715
T20	179	70	15,50	3	000970720
T25	179	70	16,50	3	000970725
T27	200	84	18,10	3	000970727
T30	200	84	18,80	3	000970730
T40	221	103	22,30	3	000970740
T45	236	106	26,00	2	000970745
T50	255	117	33,50	2	000970750



97TTX/S6 T10-T15-T20-T25-T30-T40	€ 102,00	1	000970791
97TTX/S8 T8-T10-T15-T20-T25- T27-T30-T40	134,00	1	000970808
97TTX/S11 T8-T9-T10-T15-T20-T25- T27-T30-T40-T45-T50	207,00	1	000970800
97TTX/S13 T6-T7-T8-T9-T10-T15-T20-T25- T27-T30-T40-T45-T50	233,00	1	000970813



97TTX/SP11 T8-T9-T10-T15-T20-T25- T27-T30-T40-T45-T50	€ 250,00	1	000970840
96T/SPV 96T/S11 97TTX/S11	49,00	1	000960958

98KZN

chaves macho hexagonal com perfil XZN®



DIN 65253

	L mm	L1 mm	€		
M5	83	25	6,30	5	000980005
M6	89	30	7,20	5	000980006
M8	97	32	9,20	5	000980008
M10	106	35	12,00	5	000980010
M12	116	37	15,20	5	000980012



98XZN/B5 M5-M6-M8-M10-M12	€ 52,00	1	000980650
96N/BV	2,16	1	000960651

99

chaves de unha quadrada para porcas com encaixes laterais UNI/ISO 2982, 2983



UNI 6752

	A mm	€		
12-14	1,5	12,10	3	000990012
16-18-20	1,8	12,10	3	000990016
22-25-28	1,8	16,20	3	000990022
30-32	2,1	16,20	3	000990030
34-36-38	2,4	19,70	3	000990034
40-42	2,4	19,70	3	000990040
45-50	2,5	24,40	3	000990045
52-55-58	2,5	24,40	3	000990052
62-65	3,1	30,50	3	000990062
68-70-75	3,1	30,50	3	000990068
80-85-90	3,8	41,00	2	000990080
92-95	4,3	41,00	2	000990092
98-100	4,3	41,00	2	000990098
105-110-115	4,4	65,00	1	000990105
120-125-130	4,9	65,00	1	000990120
135-145	6,0	95,50	1	000990135
155-165	6,0	95,50	1	000990155

99SQ

chaves de unha quadrada articulada para porcas com encaixes laterais



Ø mm	B mm	€	U	IT
15-35	2,7	32,50	2	000990215
35-50	3,5	37,00	2	000990235
50-80	4,7	48,50	2	000990250
80-120	6,2	66,50	2	000990280
120-180	7,8	89,00	2	000990290

99ST

chaves de unha articulada com pino redondo amovível



Ø mm	Ø mm	B mm	€	U	IT
15-35	3,0	2,5	33,50	2	000990315
35-50	4,0	4,5	39,50	2	000990335
50-80	5,0	5,0	52,50	2	000990350
80-120	6,0	7,0	71,50	2	000990380
120-180	8,0	9,0	93,00	2	000990390

99 VN/...

ponta de substituição para artigo 99ST

99ST VN/...	Ø mm	€	U	IT
99ST VN/15	15-35	9,20	1	000990295
99ST VN/35	35-50	10,60	1	000990296
99ST VN/50	50-80	13,00	1	000990297
99ST VN/80	80-120	15,00	1	000990298
99ST VN/120	120-180	19,70	1	000990299

100

chaves de compasso com unhas redondas para porcas com furos de manobra frontais



Ø mm	L mm	Ø min-max mm	€	U	IT
4,8-5,8 6,9-7,9	250	18÷100	171,00	1	001000001

100/KIT

unhas de substituição para ref^a. 100



100/KIT	€	U	IT
100/KIT	52,50	1	001000010

111E

CHAVES DE ABERTURA VARIÁVEL COM ESCALA

As novas chaves de abertura variável com escala, Beta 111E, permitem apertar e desapertar porcas e parafusos de diferentes tamanhos através dos mordentes deslizantes, que podem ser ajustados através dos rolos centrais. Cabeça inclinada a 15°, permitindo alcançar espaços de difícil acesso, como é o caso das nossas icônicas chaves mistas boca/luneta, "42"



Abertura grande

Cabeça compacta com o mordente completamente aberto

Marcação a laser dupla em mm/polegadas

Com base nas novas propriedades ergonômicas, o peso foi reduzido em 20%

Em liga de aço de alto desempenho para maior resistência mecânica à torção Tratamento térmico especial para excelente resistência ao desgaste Furo no punho para pendurar a chave

111E

chaves ajustáveis com escala, cromadas

- Rotação do pino à direita
- Escala mm/polegadas



DIN 3117 ISO 6787

L mm	L "	A max mm	€	U	IT
100	4	15	28,50	3	001110110
150	6	24	29,50	3	001110115
200	8	29	36,00	3	001110120
250	10	34	43,50	3	001110125
300	12	40	58,00	3	001110130
380	15	45	114,00	3	001110138
450	18	54	189,00	2	001110145
600	24	62	262,00	1	001110160

111EN

chaves ajustáveis com escalas, fosfatadas

- Rotação do pino à esquerda
- Escala mm/polegadas



DIN 3117 ISO 6787

L mm	L "	A max mm	€	U	IT
100	4	15	26,00	3	001110410
150	6	24	27,00	3	001110415
200	8	29	31,50	3	001110420
250	10	34	39,50	3	001110425
300	12	40	53,00	3	001110430
380	15	45	105,00	3	001110438
450	18	54	179,00	2	001110445

111ER

chaves ajustáveis de mordente reversível, com escalas, cromadas

- Mordente reversível
- Rotação do pino à direita
- Escala mm/polegadas



L mm	L "	A max mm	Ø max "	€	U	IT
200	8	29	3/4	37,50	3	001110520
250	10	34	1	46,50	3	001110525
300	12	40	1.1/4	60,50	2	001110530

111CM

chaves ajustáveis de grande abertura, cromadas, série curta

- Grande abertura
- Rotação à direita
- Escala mm/polegadas



L mm	L "	A max mm	€	U	IT
170	6	32	43,00	2	001110770
220	8	38	52,50	3	001110722
270	10	46	69,50	3	001110727

120

chaves de luneta aberta de 12 faces com sistema de roquete simples

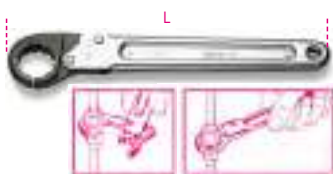

Ø mm	L mm	€	U	U
10	135	54,00	1	001200010
11	135	54,00	1	001200011
12	135	54,00	1	001200012
13	135	54,00	1	001200013
14	135	61,50	1	001200014
17	185	66,00	1	001200017
19	185	70,50	1	001200019
22	230	95,50	1	001200022
24	230	103,00	1	001200024
27	230	131,00	1	001200027
30	320	148,00	1	001200030
32	320	157,00	1	001200032



120/B6N	407,00	1	001200060
10-11-13			
17-19-22 mm			
2002/BVL6	12,70	1	020020010

123E1/4

adaptador, 1/4", para chaves de roquete de 10 mm



Ø mm	L mm	€	U	U
10	20,6	7,10	1	001230010

123Q1/4

adaptador de desengate rápido, 1/4", para chaves de roquete, 10mm

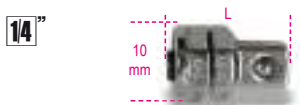

Ø mm	L mm	€	U	U
10	17,5	9,90	1	001230310

123Q3/8

adaptador de desengate rápido, 3/8", para chaves de roquete, 13mm



Ø mm	L mm	€	U	U
13	22,5	10,00	1	001230313

123Q1/2

adaptador de desengate rápido, 1/2", para chaves de roquete, 19mm



Ø mm	L mm	€	U	U
19	30,5	10,60	1	001230319

123/K4

kit com 4 adaptadores para chaves de roquete:

1 ponta adaptadora
3 adaptadores de desengate rápido



123/K4	37,50	1	001230504
--------	-------	---	-----------

141

chaves boca/luneta com sistema de roquete, série reta



ISO 21982:2020

Ø mm	L mm	€	U	U
8x8	136	17,80	3	001410008
9x9	143	18,60	3	001410009
10x10	160	19,10	3	001410010
11x11	168	19,50	3	001410011
12x12	174	20,20	3	001410012
13x13	180	22,00	3	001410013
14x14	193	22,90	2	001410014
15x15	200	23,90	2	001410015
16x16	216	26,00	2	001410016
17x17	233	27,00	2	001410017
18x18	239	28,50	2	001410018
19x19	250	29,00	2	001410019



141/B6	148,00	1	001410066
8-10-13-14-17-19 mm			
141/B9	214,00	1	001410069
8-10-11-12-13-14-15-17-19 mm			



141/S12	274,00	1	001410072
8-9-10-11-12-13-14-15-16-17-18-19 mm			

142

CHAVES DE ROQUETE

O roquete de ação rápida com 72 dentes proporciona um ângulo de penetração não superior a 5°, resultando num aperto rápido e preciso.

1 A boca fixa possibilita um aperto forte, com base no veio longo.

2 A alavanca de inversão integrada evita o risco de inversão acidental.



3 A extremidade de luneta bi-sextavada tem um ângulo de 15°, para proteção da mão e fácil acesso.

4 A cabeça fixa tem um ângulo de 15° em relação ao eixo, obtendo-se assim um ângulo de penetração reduzido.



142

chaves boca/luneta com sistema de roquete



ISO 21982:2020

Ø mm	L mm	€	U	U
6x6	136	19,50	3	001420006
7x7	136	19,50	3	001420007
8x8	136	20,10	3	001420008
9x9	143	21,50	3	001420009
10x10	159	22,10	3	001420010
11x11	168	22,80	3	001420011
12x12	174	23,60	3	001420012
13x13	180	25,50	3	001420013
14x14	190	26,00	2	001420014
15x15	200	28,00	2	001420015
16x16	216	30,00	2	001420016
17x17	233	31,00	2	001420017
18x18	239	33,50	2	001420018
19x19	248	34,00	2	001420019
21x21	285	43,50	1	001420021
22x22	285	45,50	1	001420022
24x24	325	52,50	1	001420024
27x27	355	76,00	1	001420027
30x30	420	89,00	1	001420030
32x32	420	92,50	1	001420032
34x34	482	129,00	1	001420034
36x36	482	130,00	1	001420036
38x38	482	133,00	1	001420038



142/B6	€ 169,00	1	001420066
8-10-13-14-17-19 mm			
142/BV6	€ 9,90	1	001420076
142/B9	€ 245,00	1	001420069
8-10-11-12-13-14-15-17-19 mm			
142/BV9	€ 11,80	1	001420079



142/S15	€ 402,00	1	001420074
6-7-8-9-10-11-12-13 14-15-16-17-18-19-22 mm			
142/S17	€ 555,00	1	001420068
6-7-8-10-11-12-13-14-15- 16-17-18-19-21-22-24-27 mm			
142/S19	€ 715,00	1	001420075
6-7-8-9-10-11-12 13-14-15-16-17-18 19-22-24-27-30-32 mm			

142/SC9I-E

jogo de 9 chaves mistas boca luneta, com sistema de roquete, suporte compacto



142/SC9I	€ 242,00	1	001420087
8-10-11-12-13-14-15-17-19 mm			
142/SCV9I	€ 11,50	1	001420103
142/SC9E	€ 252,00	1	001420088
8-10-11-12-13-16-17-18-19 mm			
142/SCV9E	€ 11,50	1	001420104

142MC

chaves mistas boca/luneta, com sistema de roquete reservável, coloridas



ISO 21982:2020

mm	L mm	€		
8x8	136	21,20	3	001422008
10x10	159	23,20	3	001422010
11x11	168	23,70	3	001422011
12x12	174	24,80	3	001422012
13x13	180	26,50	3	001422013
14x14	190	28,00	2	001422014
15x15	200	29,00	2	001422015
16x16	216	32,00	2	001422016
17x17	233	32,50	2	001422017
18x18	239	34,50	2	001422018
19x19	248	35,50	2	001422019



142MC/SC9I	€ 254,00	1	001422087
8-10-11-12-13-14-15-17-19 mm			
142MC/SC9E	€ 264,00	1	001422088
8-10-11-12-13-16-17-18-19 mm			

142AS

chaves boca/luneta com sistema de roquete



mm	L mm	€		
5/16x5/16	136	23,70	2	001420308
3/8x3/8	159	24,20	2	001420310
7/16x7/16	168	25,50	2	001420311
1/2x1/2	180	29,00	2	001420313
9/16x9/16	190	29,50	2	001420314
5/8x5/8	216	32,50	2	001420316
11/16x11/16	233	33,50	2	001420317
3/4x3/4	248	36,50	2	001420319



142AS/8	€ 235,00	1	001420330
5/16-3/8-7/16-1/2 9/16-5/8-11/16-3/4			

142C

chaves boca/luneta, série curta



ISO 21982:2020

mm	L mm	€		
8x8	88	14,50	2	001420108
9x9	96	14,50	2	001420109
10x10	96	15,10	2	001420110
11x11	100	16,10	2	001420111
12x12	104	17,10	2	001420112
13x13	108	17,80	2	001420113
14x14	114	18,60	2	001420114
15x15	118	19,20	2	001420115
16x16	122	19,80	2	001420116
17x17	128	21,50	2	001420117
18x18	132	23,20	2	001420118
19x19	138	23,70	2	001420119



142C/A12	€ 250,00	1	001420175
8-9-10-11-12-13-14 15-16-17-18-19 mm			

142SN

chaves boca/luneta articulada com sistema de roquete



ISO 21982:2020

mm	L mm	€		
7x7	136	23,40	2	001420207
8x8	136	24,20	2	001420208
9x9	143	25,50	2	001420209
10x10	160	26,50	2	001420210
11x11	168	28,00	2	001420211
12x12	174	29,00	2	001420212
13x13	180	31,00	2	001420213
14x14	193	32,00	2	001420214
15x15	200	34,00	2	001420215
16x16	216	36,00	2	001420216
17x17	233	36,50	2	001420217
18x18	239	39,50	2	001420218
19x19	250	40,00	2	001420219
22x22	285	47,50	1	001420222
24x24	325	53,00	1	001420224



142SN/S13	€ 405,00	1	001420263
7-8-9-10-11-12-13-14 15-16-17-18-19 mm			



142SN/SC9	€ 290,00	1	001420259
8-10-11-12-13-14-15-17-19 mm			

186

chave auto-ajustável, 8 a 32 mm

Ideal para parafusos de cabeça sextavada, quadrada, Spline e Torx®, mesmo danificados.



L mm	€	U	IT
260	55,50	1	001860008

187

chave de luneta articulada



mm	L mm	€	U	IT
8x9	125	37,50	1	001870008
10x11	155	40,50	1	001870010
12x13	175	41,50	1	001870012
14x15	205	46,00	1	001870014
16x17	235	52,00	1	001870016



€	U	IT
229,00	1	001870050

187/B5
8x9-10x11-12x13
14x15-16x17 mm

188

chaves de luneta plana bi-sextavadas com roquete para polias livres de alternador



mm	L mm	€	U	IT
10	240	25,00	2	001880010
15	322	34,50	2	001880015

192

chaves bi-hexagonais com sistema de roquete reversível, cromadas, 4 in 1



mm	L mm	€	U	IT
8x10/12x13	160	32,00	1	001920008
16x17/18x19	230	41,00	1	001920016

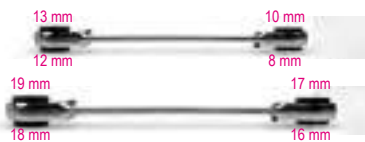

€	U	IT
73,50	1	001920070

192/S2
8x10/12x13 mm
16x17/18x19 mm

194

chave de caixa com sistema de roquete reversível



mm	L mm	€	U	IT
1/4x5/16	128	41,00	2	001940006

195

chave de luneta dupla, bi-hexagonal, com sistema de roquete



mm	L mm	€	U	IT
8x10	128	22,40	2	001950010
12x13	170	25,50	2	001950013
14x15	190	27,00	2	001950015
16x18	230	31,50	2	001950018
17x19	230	33,50	2	001950019



€	U	IT
152,00	1	001950066

195/B5
8x10-12x13-14x15
16x18-17x19 mm

195/BV5
11,80
1 001950070

195AS

chave de luneta dupla cromada, bisextavada, com sistema de roquete



mm	L mm	€	U	IT
5/16x3/8	128	23,20	2	001950606
7/16x1/2	170	25,50	2	001950611
9/16x5/8	190	29,00	2	001950614
11/16x3/4	230	32,50	2	001950617



€	U	IT
123,00	1	001950654

195AS/B4
5/16x3/8 - 7/16x1/2 -
9/16x5/8 - 11/16x3/4

195FTX/BV4
11,80
1 001950520

195P

chave bi-hexagonal dupla inclinada a 15° e com sistema de roquete reversível



ISO 21982:2020

mm	L mm	€	U	IT
8x10	128	34,00	2	001950210
12x13	170	36,00	2	001950213
14x15	190	37,00	2	001950215
16x18	230	41,50	2	001950218
17x19	230	43,50	2	001950219



€	U	IT
204,00	1	001950266

195P/B5
8x10-12x13-14x15
16x18-17x19 mm

195/BV5
11,80
1 001950070

310

ferro de soldar tubos e uniões de pequenas dimensões em plástico tipo PE, PP, PVC e PEHD



mm	€	U	IT
16÷63	416,00	1	003100002

310/2

310B

matrizes para o polifusor modelo 310



mm	€	U	IT
16	71,00	1	003100016
20	78,00	1	003100020
25	83,50	1	003100025
32	92,50	1	003100032
40	109,00	1	003100040
50	138,00	1	003100050
63	159,00	1	003100063



310/C8

jogo com polifusor e 7 matrizes



310/C8
310/2+310B: Ø 16-20-25
32-40-50-63

€ 935,00 1 003100108

440x270x120 mm - 7,7 kg

311

ferro de soldar tubos e uniões de grandes dimensões em plástico tipo PE

CE

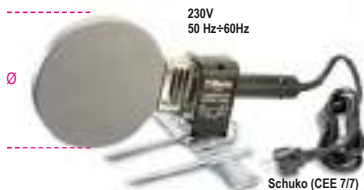

230V
50 Hz+60Hz

Schuko (CEE 7/7)

	Ø mm	Watt	€		
311/1	120	300	371,00	1	003110001
311/2	190	900	412,00	1	003110002

CAMPOS DE APLICAÇÃO DOS CORTA-TUBOS

Os corta-tubos Beta cobrem uma ampla gama de aplicações. Os seus rolos suaves, o parafuso ou alimentador telescópico possibilitam cortes limpos e precisos em todos os materiais utilizados na construção de tubagens.

O quadro abaixo indica as combinações de corta-tubos/discos de corte para cada material.

	TUBOS DE GÁS EM AÇO			TUBOS DE GÁS EM AÇO INOX		
	10 mm 1/8"	60 mm 2"	115 mm 4"	10 mm 1/8"	60 mm 2"	115 mm 4"
330/2						
330/4						
				330/2+330R/12		
				330/4+330R/14		

	TUBOS DE LIGA LEVE E COBRE							
	3 mm 1/8"	6 mm 1/4"	8 mm 5/16"	16 mm 5/8"	28 mm 1"1/8"	30 mm	38 mm 1"1/2"	67 mm 2"5/8"
332								
334								
336								
338								

	TUBOS EM AÇO INOX FINOS							
	3 mm 1/8"	6 mm 1/4"	8 mm 5/16"	16 mm 5/8"	28 mm 1"1/8"	30 mm	38 mm 1"1/2"	67 mm 2"5/8"
332 + 334R/1								
334 + 334R/1								
336 + 338R/1								
338 + 338R/1								

	TUBOS EM PLÁSTICO							
	6 mm 1/4"	8 mm 5/16"	16 mm 5/8"	30 mm 1"1/8"	38 mm 1"1/2"	50 mm 2"	67 mm 2"5/8"	127 mm 5"
336 + 338RP								
338 + 338RP								
339A								

330

corta-tubos para tubos de gás em aço



	Ø mm -"	L mm	€		
330/2	10÷60 1/8"÷ 2"	380	177,00	1	003300002
330/4	60÷115 2"÷ 4"	585	402,00	1	003300004

330R/A

cortante de substituição para o modelo 330 para tubos em aço



	Ø mm	S mm	€		
330R/A2	32	7	17,00	1	003300012
330R/A4	42	9	44,00	1	003300014

330R/1

cortante de substituição para o artigo 330 para tubos de aço inox



	Ø mm	S mm	€		
330R/12	32	7	38,00	1	003300024
330R/14	32	9	107,00	1	003300034

331C

corta-tubos portátil em C para cobre e ligas leves



	Ø mm	L mm	€		
331C	15÷22	78	63,00	1	003310050

332

mini corta-tubos para cobre e ligas leves



Ø mm - "	L mm	€	🔧	📄
3÷16 1/8"÷5/8"	59	25,50	2	003320001
3÷28 1/8"÷1"1/8"	63	28,50	2	003320003

334

corta-tubos para cobre e ligas leves



Ø mm - "	L mm	€	🔧	📄
3÷30 1/8"÷1"1/8"	150	35,00	1	003340001

334R

cortante de substituição para os modelos com refª. 332 e 334 para cobre e ligas leves



334R	Ø mm	€	🔧	📄
	18	7,50	1	003340021

334R/I

cortante de substituição para os modelos com refª. 332 e 334 para aço inox



334R/I	Ø mm	€	🔧	📄
	18	21,40	1	003340023

336

corta-tubos com avanço telescópico para cobre e ligas leves



Ø mm - "	L mm	€	🔧	📄
6÷38 1/4"÷1"1/2"	160	58,00	1	003360001

338

corta-tubos com avanço telescópico rápido para cobre, ligas leves e plásticos



Ø mm - "	L mm	€	🔧	📄
6÷67 1/4"÷2"5/8"	290	145,00	1	003380001

338R

cortante de substituição para os modelos 331L, 336 e 338 para cobre e ligas leves



338R	Ø mm	€	🔧	📄
	18,5	8,00	1	003380022

338R/I

cortante de substituição para os modelos 336 e 338 para aço inox



338R/I	Ø mm	€	🔧	📄
	21,8	23,70	1	003380023

338RP

cortante de substituição para os modelos 336 e 338 para plástico



338RP	Ø mm	€	🔧	📄
	21,9	8,70	1	003380025

339A

corta-tubos com avanço telescópico rápido para tubos de plástico



Ø mm - "	L mm	€	🔧	📄
50÷127 2"÷ 5"	345	309,00	1	003390011

339A/R

cortante de substituição para o modelo 339A



339A/R	Ø mm	€	🔧	📄
	42	21,40	1	003390061

340

alicate para corte de tubos multi-camadas max. Ø 26 mm

- Lâmina com revestimento PTFE
- 4 rolos de suporte para facilitar a rotação do tubo durante o trabalho
- Punho com sistema integrado para corte de tubos ondulados
- Corpo leve em magnésio
- Ø máx.: 26 mm



340	Ø max mm	€	🔧	📄
	26	120,00	1	003400001

340RL

Lamina de substituição para o item 340



340RL	€	🔧	📄
	34,00	1	003400010

340C

alicate corta-tubos para tubos corrugados

- alicates em liga de alumínio e magnésio
- compactos, tamanho de bolso, leves
- lâmina adicional para corte longitudinal



Ø mm	L mm	€		
14-45	134	57,00	1	003400050

340C/KRL

kit de 3 lâminas de substituição para 340C



340C/KRL	€		
	34,00	1	003400055

341

alicate corta-tubos para tubos plásticos



Ø mm	L mm	€		
0÷25	190	43,00	1	003410001

341RL

lâmina de substituição para o modelo 341



341RL	€		
	19,30	1	003410010

341B

tesoura com roquete para tubos de plástico



Ø mm	L mm	€		
0÷35	195	79,00	1	003410051

341B/RM

mola de substituição para o artigo 341B

341B/RM	€		
	2,94	1	003410061

341B/RL

lâminas de substituição para o artigo 341B



341B/RL	€		
	29,50	1	003410060

342

Tesoura com roquete para tubos de plástico



Ø mm - " 0÷42 1"5/8	L mm 200	€		
		57,50	1	003420030

342MOL

mola de substituição para o artigo 342

342MOL	€		
	4,20	1	003420033

342RL

lâmina de substituição para o artigo 342



342RL	€		
	26,50	1	003420032

342A

tesoura com roquete para tubos plásticos



Ø mm - " 0÷50 2"	L mm 270	€		
		118,00	1	003420101

342A/MOL

mola de substituição para artigo 342A

342A/MOL	€		
	2,54	1	003420111

342A/RL

lâmina de substituição para o modelo 342A



342A/RL	€		
	61,50	1	003420110

342P

tesoura com roquete para tubos plásticos, corpo em liga de magnésio



Ø mm - " 0÷50 2"	L mm 260	€		
		128,00	1	003420121

342P/RL

lâmina de substituição para ref. 342P



342P/RL	€		
	53,50	1	003420130

 Beta

345

ferramenta rebarba-tubos
corpo em metal

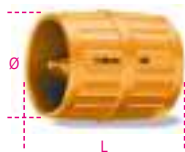

Ø mm - "	L mm	€	🔧	📦
3÷42 1/8"÷1"5/8	58	31,00	5	003450001

345U

ferramenta rebarba-tubos para aço inoxidável,
aço, cobre e ligas leves



Ø mm - "	L mm	€	🔧	📦
4÷36 5/32÷1"7/16	60	82,00	1	003450050

345U/A

adaptador para ferramenta rebarba-tubos
345U,
para pontas encabadouro sextavado 1/4"



L mm	€	🔧	📦
90	20,80	3	003450055

345C

manómetro para tubos com várias camadas



Ø mm	€	🔧	📦
16-20-26-32	49,00	1	003450032

345SB

rebarbador de lâmina giratório
com lâmina intermutável



L mm	€	🔧	📦
150	25,50	5	003450010

345SB/R

lâmina de substituição
para o modelo 345SB



345SB/R	€	🔧	📦
	9,00	3	003450015

345SB2

raspador
com lâmina fixa



L mm	€	🔧	📦
140	12,80	5	003450022

345SC

escova 4 em 1 para diâmetros
interiores e exteriores,
1/2" e 3/4"



L mm	L1 mm	L2 mm	€	🔧	📦
195	28	32	14,90	2	003450060

345SI

raspador para uso interno,
com lâmina rotativa de substituição



L mm	Ø mm	€	🔧	📦
168	16,5	48,50	1	003450040

345SI/R

lâmina de substituição para artigo 345SI



345SI/R	€	🔧	📦
	33,50	1	003450045

349

abocardador com embraiagem para tubos em
cobre e ligas leves



Ø mm - "	€	🔧	📦
6-8-10-12-14-15-16-18 (1/8-3/16-1/4-5/16 3/8-1/2-5/8-3/4)	307,00	1	003490001

270x200x50 mm - 2,7 kg

349/SMM

fixador de tubos métrico para artigo 349



Ø mm	€	🔧	📦
6-8-10-12-14-15-16-18	90,00	1	003490011

349/SMAS

fixador de tubos em polegadas para artigo 349



Ø "	€	🔧	📦
1/8-3/16-1/4-5/16 3/8-1/2-5/8-3/4	85,00	1	003490012

350

abocardador, para tubos em cobre e ligas leves

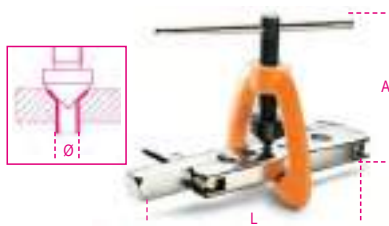

∅ mm	L mm	A mm	€	U	IT
4-4,75-6-8-10-12-14	175	104	89,00	1	003500001

351C

corta-tubos e abocardador



351C	€	U	IT
	161,00	1	003510010

334	∅ 3÷30 mm (1/8"÷1"1/8")
350	∅ 4÷14 mm
351P	∅ 4-4,75-6-8-10-12-14 mm

225x150x45 mm - 1,6 kg

351P

punções para abocardador refª. 350



351P	∅ mm	€	U	IT
351P 4	4	7,40	3	003510101
351P 4,75	4,75	7,40	3	003510102
351P 6	6	7,40	3	003510103
351P 8	8	7,40	3	003510104
351P 10	10	7,40	3	003510105
351P 12	12	7,40	3	003510106
351P 14	14	7,40	3	003510107

352U

abocardador regulável para cobre e ligas leves

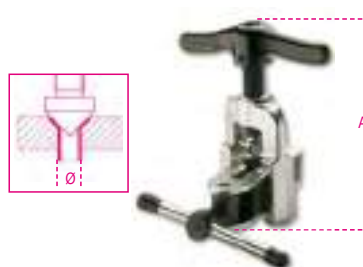

∅ mm - "	A mm	€	U	IT
5÷16 3/16÷5/8	130	106,00	1	003520101

352C/U

jogo corta-tubos, rebarbador e abocardador, artigos 334, 345SB e 352U



352C/U	€	U	IT
	208,00	1	003520110

334	∅ 3÷30 mm (1/8"÷1"1/8")
345SB	
352U	∅ 5÷16 mm (3/16"÷5/8")

335x145x60 mm - 2120 g

355

chave de 5 graduações para radiadores



∅ "	L mm	€	U	IT
3/8" - 1/2" 3/4" - 1"	90	42,00	2	003550001

357F3

nível com 3 bolhas



∅ "	L mm	€	U	IT
3/8" / 1/2"	90÷220	133,00	1	003570100

357R/F3

bolha de substituição para nível 357F3



357R/F3	€	U	IT
	21,50	1	003570101

358

aparelhos para chanfrar externamente tubos plásticos



358/1	∅ mm	€	U	IT
358/1	16÷110	188,00	1	003580001
358/2	40÷250	188,00	1	003580002

358RL

lâmina de substituição com batente para os modelos 358/1 e 358/2



358RL	€	U	IT
	34,50	1	003580011

359

chave universal para bujões



∅ "	L mm	A mm	€	U	IT
1"÷1"1/4	160	140	92,50	1	003590001

Beta

359CH

adaptador para bujões em cruz para o modelo 359



Ø "	L mm	€	🔧	📄
1"1/2	74	52,50	1	003590005

360

chaves para tubos modelo Stillson



L mm	Ø max"	Ø max mm	€	🔧	📄
250	1" gas	34	38,50	1	003600025
350	1"1/2 gas	49	51,00	1	003600035
450	2" gas	60	71,00	1	003600045
600	2"1/2 gas	76	109,00	1	003600060
900	3"1/2 gas	102	301,00	1	003600090

360R/...

kit peças de substituição para ref. 360 com mordente móvel e porca.

	€	🔧	📄
360R 250	14,30	1	003600025
360R 350	19,70	1	003600035
360R 450	28,50	1	003600045
360R 600	42,00	1	003600060
360R 900	75,00	1	003600090

361N

chave de tubos de alavanca ajustável



L mm	Ø max"	Ø max mm	€	🔧	📄
350	1" 1/2	49	79,50	1	003610014

362

chaves para tubos modelo americano



L mm	Ø max"	Ø max mm	€	🔧	📄
200	1" gas	34	33,50	1	003620020
250	1"1/2 gas	49	42,50	1	003620025
300	2" gas	60	51,00	1	003620030
350	2" gas	60	61,00	1	003620035
450	2"1/2 gas	76	87,50	1	003620045
600	3" gas	90	133,00	1	003620060
900	5" gas	140	163,00	1	003620090

362R/...

kit peças de substituição para ref. 362 com: mordente fixa, mordente móvel; porca; pino de segurança.

	€	🔧	📄
362R 200	7,10	1	003620020
362R 225	10,10	1	003620025
362R 300	12,50	1	003620030
362R 350	14,30	1	003620035
362R 450	19,60	1	003620245
362R 600	26,50	1	003620260
362R 900	65,50	1	003620290

363

chaves para tubos modelo americano em ligas leves



L mm	Ø max"	Ø max mm	€	🔧	📄
350	2" gas	60	73,00	1	003630035
450	2"1/2 gas	76	98,50	1	003630045
600	3" gas	90	166,00	1	003630060
900	5" gas	140	312,00	1	003630090
1200	6" gas	165	330,00	1	003630120

363R/...

kit peças de substituição para ref. 363 com: mordente fixa, mordente móvel; porca; pino de segurança.

	€	🔧	📄
363R 350	15,80	1	003630035
363R 450	20,90	1	003630045
363R 600	29,00	1	003630060
363R 900	57,00	1	003630290
363R 1200	88,00	1	003630320

365

chaves para tubos modelo frontal em ligas leves



L mm	Ø max"	Ø max mm	€	🔧	📄
350	2" gas	60	91,50	1	003650035
450	2"1/2 gas	76	126,00	1	003650045

365R/...

kit peças de substituição para ref. 365 com: mordente fixa, mordente móvel; porca; pino de segurança.

	€	🔧	📄
365R 350	68,50	1	003650235
365R 450	102,00	1	003650245

366

chaves para tubos modelo ligeiro



L mm	Ø max"	Ø max mm	€	🔧	📄
175	1" gas	34	34,50	1	003660017
225	1"1/2 gas	49	41,00	1	003660022
275	2" gas	60	49,50	1	003660027
300	2"1/2 gas	76	54,00	1	003660030
350	3" gas	90	61,00	1	003660035

374

chaves para tubos modelo Sueco mordentes a 45°



DIN 5234

L mm	Ø max"	Ø max mm	€	🔧	📄
240	1/2" gas	21	40,00	1	003740024
320	1" gas	34	54,00	1	003740032
410	1"1/2 gas	49	70,50	1	003740041
550	2" gas	60	110,00	1	003740055
630	3" gas	90	196,00	1	003740063

375

chave para tubos modelo Sueco com mordentes a 45°



DIN 5234

L mm	Ø max"	Ø max mm	€	🔧	📄
320	1" gas	34	54,00	1	003750032
410	1"1/2 gas	49	70,50	1	003750041
550	2" gas	60	110,00	1	003750055

376

chaves para tubos modelo Sueco mordentes planos a 90°



DIN 5234

L mm	Ø max"	Ø max mm	€	🔧	📄
320	1" gas	34	54,00	1	003760032
410	1"1/2 gas	49	70,50	1	003760041
550	2" gas	60	110,00	1	003760055
630	3" gas	90	200,00	1	003760063

378

chaves para tubos modelo Sueco mordentes a 45°



DIN 5234

L mm	Ø max" gas	Ø max mm	€	🔧	📄
250	1/2"	21	42,50	1	003780025
320	1"	34	56,50	1	003780032
410	1 1/2"	49	73,00	1	003780041
550	2"	60	121,00	1	003780055
650	3"	90	203,00	1	003780065

374R/...

kit completo peças de substituição para refs. 374 - 375 - 376 - 378 com porca e batente

	€	🔧	📄
374R 240 x 374/240-378/250	2,37	1	003740724
374R 320 x 374/320-376/320-378/320	2,63	1	003740732
374R 410 x 374/410-375/410-376/410-378/410	3,25	1	003740741
374R 550 x 374/550-376/550-378/550	3,85	1	003740755
374R 630 x 374/630-378/650	5,90	1	003740763

383

chaves para tubos de correia



	Ø max" gas	Ø max mm	L mm	€	🔧	📄
383/1	3"	90	300	57,50	1	003830001
383/2	8" gas	220	300	61,00	1	003830002

383R

correia de substituição para o modelo 383

	S mm	€	🔧	📄
383R/1	27	23,40	1	003830010
383R/2	27	24,70	1	003830015

384

chave de corrente para tubos reversível



	Ø max" gas	Ø max mm	L mm	€	🔧	📄
384	4" gas	115	300	78,00	1	003840032

384RC

corrente de substituição para o modelo 384



	€	🔧	📄
384RC	48,00	1	003840033

386A

chaves de corrente reversíveis, para trabalhos pesados



	Ø max" gas	L mm	€	🔧	📄
386A/1	4" gas 115 mm	900	264,00	1	003860001
386A/2	6" gas 168 mm	900	489,00	1	003860002
386A/5	8" gas 220 mm	1100	630,00	1	003860005
386A/6	12" gas 324 mm	1300	1.100,00	1	003860006

386A/RC

correntes de substituição para o modelo 386A



	€	🔧	📄
386A1/RC	82,50	1	003860011
386A2/RC	117,00	1	003860012
386A5/RC	156,00	1	003860015
386A6/RC	274,00	1	003860016



387

alicate dobra-tubos para cobre e metal não ferroso, com matrizes intercambiáveis 3/16"-1/4"-5/16"-3/8"



L mm	Ø mm	€	🔧	📄
255	3/16"-1/4"-5/16"-3/8"	52,50	1	003870001

387R

matrizes de substituição para item 387



Ø"	€	🔧	📄
3/16"-1/4"	13,30	1	003870010
5/16"-3/8"	14,00	1	003870015

388

curva tubos para tubos de baixa espessura em cobre, ligas leves ou aço macio



Ø mm	L mm	R mm	€	🔧	📄
6	305	18,0	66,00	1	003880006
8	315	23,5	71,00	1	003880008
10	350	31,0	82,00	1	003880010
12	360	31,0	87,00	1	003880012
14	455	46,5	113,00	1	003880014
15	465	46,5	120,00	1	003880015
16	465	46,5	129,00	1	003880016

388A

alicate curva-tubos para tubos de baixa espessura em cobre e ligas leves



	Ø mm	L mm	€	🔧	📄
388A/1	6-8-10 mm	220	71,50	1	003880051
388A/2	1/4"-5/16"-3/8"	220	71,50	1	003880055

388C/C8

curvadora de tubos com 7 matrizes,
para tubos finos de cobre e liga leve



388C/C8	∅ mm	€	1	003880200
	10-12-14-16 18-20-22	525,00		
400x330x110 mm - 3,6 kg				

389/K4

kit de molas curva-tubos
para tubos em cobre
utilização externa



389/K4	∅ "	L mm	€	1	003890001
	1/4-3/8-1/2-5/8	290	22,10		

392C

alicate ajustável para sifões



392C	∅ mm	L mm	€	1	003920100
	25÷65	260	49,00		

392RG/C

par de protectores de substituição para ref.
392C



392RG/C	€	1	003920101
	6,80		

Beta

393

alicate para porcas de torneira



393	L mm	€	1	003930001
	270	71,50		

395

chave articulada para porcas
de lavatórios



395	∅ mm	L mm	€	1	003950001
	15÷32	240	47,00		
	5/8"±1"1/4				

395T

chave articulada telescópica
para porcas de lavatórios



395T	∅ mm	L mm	€	1	003950100
	10÷32	250÷430	63,50		
	3/8"±1"1/4				

398

torno de bancada com corrente



398	∅ "	L mm	€	1	003980008
	1/2-8"	250	325,00		

399

torno de bancada

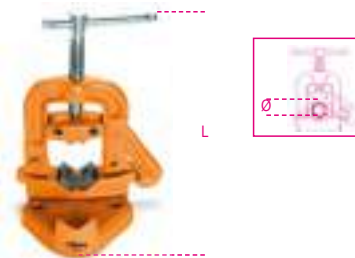

399	∅ mm	L min mm	€	1	003990005
	10÷60	220	200,00		
	1/8÷2"				
	10÷89	290	358,00		
	1/8÷3"				

399R/...

kit de substituição para item 399
inclui dois mordentes inferiores e um
mordente superior



399R	∅ "	€	1	003990105
	1/8-2"	26,00		
	1/8-3"	41,50		

Beta

QUADRO DE BROCAS HELICOIDAIS

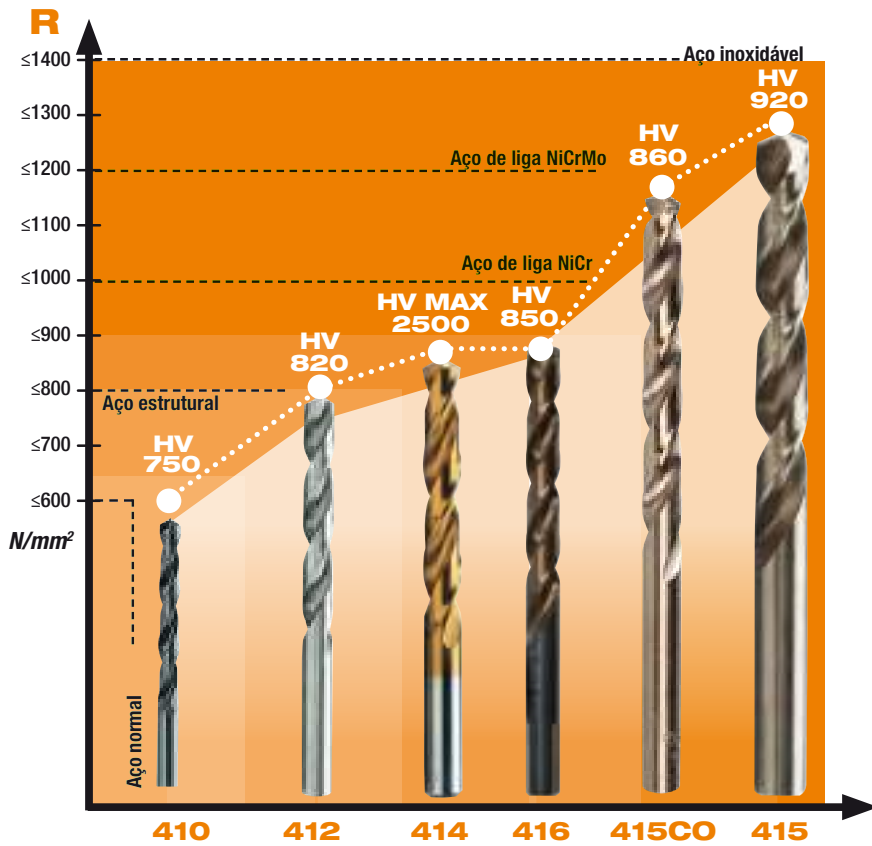

R N/mm² – Resistência mecânica do material à broca.

HV – Dureza da broca helicoidal de acordo com a escala Vickers: quanto mais elevado for o valor, maior a dureza do material.

GUIA PARA BROCAS HELICOIDAIS COM VEIO CILÍNDRICO

Brocas helicoidais – Brocas helicoidais obtidas a partir de processo de laminagem a quente. Brocas de boa qualidade, para trabalhos leves, ex. furação em ferro, aço macio, ligas leves e metais não-ferrosos em geral.

Brocas helicoidais retificadas – Brocas helicoidais totalmente obtidas a partir de retificação de barra de aço com tratamento a quente. Brocas de alta performance para furar aço e ligas leves: eficiência constante, excelente remoção de aparas e precisão ao furar.

HSS – Aço de alta velocidade, extremamente duro, e resistente a altas temperaturas; o melhor material para ferramentas de corte, de rosca e de escarear.

Cobalto (Co) – Elemento à base de ligas, que fornece ao aço uma maior capacidade de resistência ao calor e menor desgaste da broca, por ex., a altas temperaturas. Quanto maior o índice de cobalto, melhor a performance da ferramenta. As ligas mais comuns possuem 5% ou 8% de cobalto.

HSS-Co – Aço de alta velocidade com 5% ou 8% de cobalto.

TiN – Revestimento ultrafino de nitrito de titânio; com base no seu fator de elevada dureza e baixa fricção, proporciona maior resistência ao desgaste e oxidação, bem como uma melhor remoção de aparas.

Aço cromado – As ferramentas em aço cromado são adequadas para utilização manual ao rosca ferro, ligas leves, aço sem tratamento e aço com tratamento a quente de baixa dureza. São muito utilizadas na limpeza e reparação de roscas danificadas em todos os trabalhos profissionais em geral e no setor automóvel em particular.

Metal duro – Material com elevada resistência ao desgaste, utilizado em chapas para brocas de alvenaria.

Afiação 118° – Ângulo de afiação standard de brocas helicoidais para metal, que permite furar metais rapidamente, para uma centragem mais fácil e excelente dissipação de calor.

Afiação 130° – Ângulo de afiação amplo, para mais precisão em operações de perfuração prévias e necessitando de menos força ao furar.

Afiação dupla 115°/135° – Benefícios combinados dos dois ângulos, mais função de quebra de aparas; a melhor escolha para matérias que produzem aparas longas.

SDS-Plus – Rapidez, a escolha mais segura para brocas de percussão.

410

brocas cilíndricas série curta HSS

R ≤ 650 N/mm²
HV || 750+820

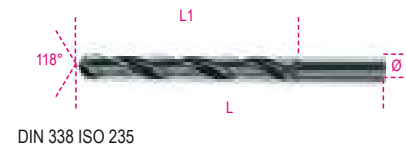

DIN 338 ISO 235

Ø mm	L mm	L1 mm	€	🔧	📄
0,50	22	6	1,80	10	004100030
1,00	34	12	1,00	10	004100040
1,25	38	16	0,82	10	004100043
1,50	40	18	0,77	10	004100046
1,75	46	22	0,77	10	004100049
2,00	49	24	0,70	10	004100052
2,25	53	27	0,82	10	004100055
2,50	57	30	0,77	10	004100058
2,75	61	33	0,82	10	004100061
3,00	61	33	0,77	10	004100064
3,20	65	36	1,04	10	004100066
3,25	65	36	1,04	10	004100067
3,50	70	39	0,98	10	004100070
3,75	70	39	1,17	10	004100073
4,00	75	43	1,07	10	004100076
4,20	75	43	1,35	10	004100078
4,25	75	43	1,35	10	004100079
4,50	80	47	1,20	10	004100082
4,75	80	47	1,39	10	004100085
5,00	86	52	1,32	10	004100088
5,25	86	52	1,89	10	004100091
5,50	93	57	1,77	10	004100094
5,75	93	57	1,94	10	004100097
6,00	93	57	1,77	10	004100100
6,25	101	63	2,31	10	004100103
6,50	101	63	2,18	10	004100106
6,75	109	69	2,77	10	004100109
7,00	109	69	2,57	10	004100112
7,50	109	69	2,70	10	004100118
8,00	117	75	3,20	10	004100124
8,50	117	75	3,35	10	004100130
9,00	125	81	4,10	5	004100136
9,50	125	81	4,50	5	004100142
10,00	133	87	4,95	5	004100148
10,50	133	87	6,00	5	004100172
11,00	142	94	7,10	5	004100184
11,50	142	94	7,40	5	004100196
12,00	151	101	8,10	5	004100210
12,50	151	101	8,90	5	004100222
13,00	151	101	9,40	5	004100234
14,00	160	108	12,50	5	004100242
15,00	169	114	14,50	5	004100250
16,00	178	120	18,10	5	004100258
17,00	184	125	20,00	3	004100262
18,00	191	130	23,70	3	004100266
19,00	198	135	27,00	3	004100270
20,00	205	140	32,00	3	004100274



	€	🔧	📄
410/SP19 Ø 1÷10 x 0,5 mm	52,00	1	004100419
410/SPVP1	29,00	1	004100421
410/SP25 Ø 1÷13 x 0,5 mm	109,00	1	004100425
410/SPVP2	40,00	1	004100427



410/SEL19 € 40,50 1 004100418
 Ø 1÷10 x 0,5 mm

410MIX/SEL19

jogo de 13 brocas 410
 e 6 com inserção de metal duro



410MIX/SEL19 € 40,50 1 004100417



Ø 1 - 1,5 - 2 - 2,5 - 3 - 3,5 - 4
 4,5 - 5 - 5,5 - 6 - 8 - 10 mm

Ø 4 - 5 - 6 - 8 - 9 - 10 mm

410A

brocas cilíndricas série curta HSS

R ≤ 650 N/mm²
 HV ~ 750+820



DIN 338 ISO 235

Ø mm	L mm	L1 mm	€		
13,50	160	108	14,70	5	004100281
14,00	160	108	14,70	5	004100283
14,50	169	114	17,10	5	004100285
15,00	169	114	17,10	5	004100287
15,50	178	120	21,10	5	004100289
16,00	178	120	21,10	5	004100291
16,50	184	125	22,20	3	004100292
17,00	184	125	22,20	3	004100293
17,50	191	130	26,50	3	004100294
18,00	191	130	26,50	3	004100295
18,50	198	135	29,50	3	004100296
19,00	198	135	29,50	3	004100297
19,50	205	140	34,50	3	004100298
20,00	205	140	34,50	3	004100299

410AS

brocas cilíndricas série curta HSS

R ≤ 650 N/mm²
 HV ~ 750+820



ANSI B94

Ø mm	L mm	L1 mm	€		
1/16	48	22	0,70	10	004100371
5/64	51	25	0,77	10	004100372
3/32	57	32	0,87	10	004100373
7/64	67	38	0,98	10	004100374
1/8	70	41	1,06	10	004100375
9/64	73	44	1,15	10	004100376
5/32	79	51	1,23	10	004100377
11/64	83	54	1,39	10	004100378
3/16	89	59	1,60	10	004100379
13/64	92	62	1,66	10	004100380
7/32	95	64	1,80	10	004100381
15/64	98	67	2,12	10	004100382
1/4	102	70	2,38	10	004100383
17/64	105	73	2,80	10	004100384
9/32	108	75	3,10	10	004100385
19/64	111	78	3,45	10	004100386
5/16	114	81	4,35	10	004100387
21/64	117	84	4,50	10	004100388
11/32	121	87	5,30	5	004100389
23/64	124	89	5,40	5	004100390
3/8	127	92	5,70	5	004100391



410AS/SP21 € 78,00 1 004100429
 Ø 1/16-5/64-3/32-7/64
 1/8-9/64-5/32-11/64-3/16
 13/64-7/32-15/64-1/4
 17/64-9/32-19/64-5/16
 21/64-11/32-23/64-3/8
 410AS/SPV1 29,50 1 004100430



410AS/SEL21 € 62,50 1 004100433
 Ø 1/16-5/64-3/32-7/64
 1/8-9/64-5/32-11/64-3/16
 13/64-7/32-15/64-1/4
 17/64-9/32-19/64-5/16
 21/64-11/32-23/64-3/8

412

brocas cilíndricas série curta
 HSS - totalmente rectificadas

R ≤ 700 N/mm²
 HV || 750+820



DIN 338 ISO 235

Ø mm	L mm	L1 mm	€		
0,50	22	6	3,15	10	004120030
1,00	34	12	2,01	10	004120040
1,25	38	16	2,15	10	004120043
1,50	40	18	1,80	10	004120046
1,75	46	22	1,80	10	004120049
2,00	49	24	1,52	10	004120052
2,25	53	27	1,94	10	004120055
2,50	57	30	1,66	10	004120058
2,75	61	33	1,94	10	004120061
3,00	61	33	1,75	10	004120064
3,25	65	36	2,28	10	004120067
3,50	70	39	2,10	10	004120070
3,75	70	39	2,50	10	004120073
4,00	75	43	2,28	10	004120076
4,25	75	43	2,93	10	004120079
4,50	80	47	2,62	10	004120082
4,75	80	47	3,15	10	004120085
5,00	86	52	2,93	10	004120088
5,25	86	52	4,15	10	004120091
5,50	93	57	3,80	10	004120094
5,75	93	57	4,65	10	004120097
6,00	93	57	3,95	10	004120100
6,25	101	63	5,80	10	004120103
6,50	101	63	5,10	10	004120106
6,75	109	69	6,50	10	004120109
7,00	109	69	6,00	10	004120112
7,25	109	69	7,30	5	004120115
7,50	109	69	6,20	5	004120118
7,75	117	75	8,30	5	004120121
8,00	117	75	7,60	5	004120124
8,25	117	75	9,30	5	004120127
8,50	117	75	9,40	5	004120130
8,75	125	81	10,30	5	004120133
9,00	125	81	9,80	5	004120136
9,25	125	81	11,30	5	004120139
9,50	125	81	10,20	5	004120142
9,75	133	87	12,60	5	004120145
10,00	133	87	11,30	5	004120148
10,25	133	87	17,20	5	004120149
10,50	133	87	15,10	5	004120150
10,75	142	94	20,50	5	004120151
11,00	142	94	18,00	5	004120152
11,25	142	94	21,80	5	004120153
11,50	142	94	19,00	5	004120154
11,75	142	94	23,70	5	004120155
12,00	151	101	20,90	5	004120156
12,25	151	101	26,00	5	004120157
12,50	151	101	22,30	5	004120158
12,75	151	101	29,50	5	004120159
13,00	151	101	23,60	5	004120160



412/SP19 € 104,00 1 004120419
 Ø 1÷10 x 0,5 mm
 410/SPVP1 29,00 1 004100421
 412/SP25 214,00 1 004120425
 Ø 1÷13 x 0,5 mm
 410/SPVP2 40,00 1 004100427
 412/SP49 515,00 1 004120449
 Ø 1÷13 x 0,25 mm
 412/SPV4 122,00 1 004120451



412/C150



412/C150 € 625,00 1 004120450

412 Ø 3 mm n. 20
 Ø 1 - 1,5 - 2 - 2,5 - 3 - 3,5 - 4 - 4,5 - 5 mm 10
 Ø 5,5 - 6 - 6,5 - 7 - 7,5 - 8 - 8,5 - 9 - 9,5 - 10 mm 5

365x230x47 mm - 3,3 kg



412/SP91 € 665,00 1 004120452
 Ø 1÷10 x 0,10 mm

412A

brocas cilíndricas série curta
 HSS - totalmente rectificadas
 e acabamento brunido

R ≤ 800 N/mm²
 HV ~ 750÷820



DIN 338 ISO 235

Ø mm	L mm	L1 mm	€	U	W
13,50	160	108	38,00	3	004120202
14,00	160	108	39,50	3	004120204
14,50	169	114	42,00	3	004120206
15,00	169	114	44,00	3	004120208
15,50	178	120	51,00	3	004120210
16,00	178	120	52,50	3	004120212
16,50	184	125	54,00	1	004120213
17,00	184	125	58,00	1	004120214
17,50	191	130	62,00	1	004120215
18,00	191	130	65,50	1	004120216
18,50	198	135	70,50	1	004120217
19,00	198	135	72,50	1	004120218
19,50	205	140	81,50	1	004120219
20,00	205	140	83,00	1	004120220

412L

brocas cilíndricas série longa
 HSS - totalmente rectificadas
 e acabamento brunido

R ≤ 800 N/mm²
 HV ~ 750÷820

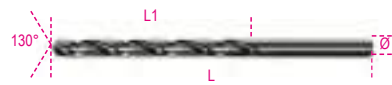

DIN 340

Ø mm	L mm	L1 mm	€	U	W
2,00	85	56	4,15	10	004120232
2,50	95	62	4,40	10	004120234
3,00	100	66	4,65	10	004120236
3,50	112	73	5,30	10	004120238
4,00	119	78	5,80	10	004120240
4,50	126	82	7,00	10	004120242
5,00	132	87	7,30	10	004120244
5,50	139	91	9,30	10	004120246
6,00	139	91	9,90	10	004120248
6,50	148	97	11,80	5	004120250
7,00	156	102	13,80	5	004120252
8,00	165	109	18,40	5	004120256
9,00	175	115	21,60	5	004120260
10,00	184	121	23,70	5	004120264

412XL

brocas helicoidais, com veio cilíndrico, série
 extra longa, HSS, totalmente retificadas

R ≤ 800 N/mm²
 HV ~ 750÷820



DIN 1869/1

Ø mm	L mm	L1 mm	€	U	W
3,00	150	100	16,00	1	004120520
3,50	165	115	17,60	1	004120522
4,00	175	120	17,60	1	004120524
4,50	185	125	18,10	1	004120526
5,00	195	135	18,10	1	004120528
5,50	205	140	22,30	1	004120530
6,00	205	140	22,30	1	004120532
6,50	215	150	26,50	1	004120534
7,00	225	155	30,50	1	004120536
7,50	225	155	35,50	1	004120538
8,00	240	165	37,50	1	004120540
8,50	240	165	39,50	1	004120542
9,00	250	175	50,50	1	004120544
9,50	250	175	54,00	1	004120546
10,00	265	185	54,00	1	004120548
10,50	265	185	54,00	1	004120550
11,00	280	195	54,00	1	004120552
12,00	295	205	69,00	1	004120556
13,00	295	205	71,50	1	004120560



414

brocas cilíndricas série curta
 HSS-TIN - totalmente rectificadas

R ≤ 900 N/mm²
 HV 0,05 | 2500



DIN 338 ISO 235

Ø mm	L mm	L1 mm	€	U	W
1,00	34	12	2,73	10	004140040
1,25	38	16	3,15	10	004140042
1,50	40	18	2,44	10	004140046
1,75	46	22	3,15	10	004140048
2,00	49	24	2,57	10	004140052
2,25	53	27	3,20	10	004140054
2,50	57	30	2,70	10	004140058
2,75	61	33	3,70	10	004140060
3,00	61	33	3,05	10	004140064
3,25	65	36	3,90	10	004140066
3,50	70	39	3,70	10	004140070
3,75	70	39	4,10	10	004140072
4,00	75	43	3,70	10	004140076
4,25	75	43	4,50	10	004140078
4,50	80	47	4,10	10	004140082
4,75	80	47	5,20	10	004140084
5,00	86	52	4,80	10	004140088
5,25	86	52	6,70	10	004140090
5,50	93	57	5,80	10	004140094
5,75	93	57	7,00	10	004140096
6,00	93	57	6,40	10	004140100
6,25	101	63	8,10	10	004140102
6,50	101	63	7,10	10	004140106
6,75	109	69	9,80	10	004140108
7,00	109	69	7,80	10	004140112
7,25	109	69	10,80	5	004140114
7,50	109	69	9,60	5	004140118
7,75	117	75	12,60	5	004140120
8,00	117	75	11,30	5	004140124
8,25	117	75	13,10	5	004140125
8,50	117	75	11,70	5	004140130
8,75	125	81	16,30	5	004140132
9,00	125	81	14,50	5	004140136
9,25	125	81	18,60	5	004140138
9,50	125	81	16,30	5	004140142
9,75	133	87	19,50	5	004140144
10,00	133	87	17,30	5	004140148
10,50	133	87	20,20	5	004140150
11,00	142	94	21,80	5	004140152
11,50	142	94	23,70	5	004140154
12,00	151	101	25,50	5	004140156
12,50	151	101	29,50	5	004140158
13,00	151	101	30,50	5	004140160



Item	€	U	W
414/SP19	151,00	1	004140419
Ø 1÷10 x 0,5 mm			
410/SPVP1	29,00	1	004100421
414/SP25	306,00	1	004140425
Ø 1÷13 x 0,5 mm			
410/SPVP2	40,00	1	004100427
414/SP49	675,00	1	004140429
Ø 1÷13 x 0,25 mm			
414/SPV4	122,00	1	004140430

414/C116



414/C116 € 615,00 1 004140450

	n.
414 Ø 1 - 1,5 - 2 - 2,5 - 3 - 3,5 - 4 - 4,5 - 5 mm	10
Ø 5,5 - 6 - 6,5 - 7 - 7,5 - 8 mm	3
Ø 8,5 - 9 - 9,5 - 10 mm	2

365x230x47 mm - 2,7 Kg

415

brocas cilíndricas série curta
HSS-CO 8% - totalmente rectificadas

R ≤ 1400 N/mm²
HV 850+920



DIN 338 ISO 235

Ø mm	L mm	L1 mm	€	1	004150029
0,50	22	6	7,70	10	004150029
1,00	34	12	3,80	10	004150040
1,25	38	16	4,20	10	004150043
1,50	40	18	3,80	10	004150046
1,75	46	22	3,95	10	004150049
2,00	49	24	3,70	10	004150052
2,25	53	27	4,50	10	004150055
2,50	57	30	4,10	10	004150058
2,75	61	33	4,50	10	004150061
3,00	61	33	4,15	10	004150064
3,25	65	36	5,80	10	004150067
3,50	70	39	5,30	10	004150070
3,75	70	39	6,40	10	004150073
4,00	75	43	5,80	10	004150076
4,25	75	43	7,20	10	004150079
4,50	80	47	6,50	10	004150082
4,75	80	47	7,50	10	004150085
5,00	86	52	7,00	10	004150088
5,25	86	52	10,20	10	004150091
5,50	93	57	9,30	10	004150094
5,75	93	57	10,70	10	004150097
6,00	93	57	9,80	10	004150100
6,25	101	63	13,80	10	004150103
6,50	101	63	12,00	10	004150106
6,75	109	69	15,90	10	004150109
7,00	109	69	14,20	10	004150112
7,25	109	69	17,20	5	004150115
7,50	109	69	15,40	5	004150118
7,75	117	75	20,10	5	004150121
8,00	117	75	18,10	5	004150124
8,25	117	75	21,80	5	004150127
8,50	117	75	20,50	5	004150130
8,75	125	81	27,00	5	004150133
9,00	125	81	23,90	5	004150136
9,25	125	81	28,50	5	004150139
9,50	125	81	26,00	5	004150142
9,75	133	87	30,50	5	004150145
10,00	133	87	28,50	5	004150148
10,25	133	87	36,50	5	004150149
10,50	133	87	31,00	5	004150150
10,75	142	94	40,50	5	004150151
11,00	142	94	36,50	5	004150152
11,25	142	94	45,50	5	004150153
11,50	142	94	40,00	5	004150154
11,75	142	94	46,50	5	004150155

Ø mm	L mm	L1 mm	€	5	004150156
12,00	151	101	43,00	5	004150156
12,25	151	101	55,50	5	004150157
12,50	151	101	46,50	5	004150158
12,75	151	101	60,50	5	004150159
13,00	151	101	49,50	5	004150160
14,00	160	108	87,50	3	004150164
15,00	169	114	104,00	3	004150168
16,00	178	120	127,00	3	004150172
17,00	186	125	144,00	1	004150174
18,00	194	130	160,00	1	004150176
19,00	202	135	184,00	1	004150178
20,00	210	140	207,00	1	004150180



	€	1	004150419
415/SP19 Ø 1÷10 x 0,5 mm	213,00	1	004150419
410/SPVP1	29,00	1	004100421
415/SP25 Ø 1÷13 x 0,5 mm	440,00	1	004150425
410/SPVP2	40,00	1	004100427
415/SP49 Ø 1÷13 x 0,25 mm	1.100,00	1	004150431
415/SPV4	122,00	1	004150432

415/C116



415/C116 € 930,00 1 004150450

	n.
415 Ø 1 - 1,5 - 2 - 2,5 - 3 - 3,5 - 4 - 4,5 - 5 mm	10
Ø 5,5 - 6 - 6,5 - 7 - 7,5 - 8 mm	3
Ø 8,5 - 9 - 9,5 - 10 mm	2

365x230x47 mm - 2,7 kg



415/SP91 € 1.280,00 1 004150460
Ø 1÷10 x 0,10 mm

415CO

brocas helicoidais, com veio cilíndrico, série curta, HSS-CO 5%, totalmente rectificadas

R ≤ 1200 N/mm²
HV ~ 800+860



DIN 338 ISO 235

Ø mm	L mm	L1 mm	€	10	004150310
1,00	34	12	1,94	10	004150310
1,50	40	18	1,94	10	004150312
2,00	49	24	1,94	10	004150314
2,50	57	30	2,01	10	004150316
3,00	61	33	2,01	10	004150320
3,50	70	39	2,50	10	004150322
4,00	75	43	2,93	10	004150324
4,50	80	47	3,35	10	004150326
5,00	86	52	3,50	10	004150328
5,50	93	57	4,40	10	004150330
6,00	93	57	4,90	10	004150332
6,50	101	63	5,90	10	004150334
7,00	109	69	7,20	10	004150336
7,50	109	69	7,90	5	004150338
8,00	117	75	9,40	5	004150340
8,50	117	75	9,80	5	004150342
9,00	125	81	11,90	5	004150344
9,50	125	81	12,60	5	004150346
10,00	133	87	14,50	5	004150348
10,50	133	87	17,60	5	004150350
11,00	142	94	19,50	5	004150352
11,50	142	94	21,40	5	004150354
12,00	151	101	23,40	5	004150356
12,50	151	101	25,50	5	004150358
13,00	151	101	28,00	5	004150360

415CO-A

brocas helicoidais, com veio cilíndrico, série curta, HSS-CO 5%, totalmente rectificadas

R ≤ 1200 N/mm²
HV ~ 800+860



DIN 338

Ø mm	L mm	L1 mm	€	3	004150364
14,00	160	108	54,00	3	004150364
15,00	169	114	62,50	3	004150366
16,00	178	120	75,50	3	004150368
17,00	184	125	77,00	1	004150370
18,00	191	130	99,00	1	004150372
19,00	198	135	114,00	1	004150374
20,00	205	140	132,00	1	004150376



DIN 338

415CO/SP19 € 112,00 1 004150421
Ø 1÷10 x 0,5 mm
410/SPVP1 € 29,00 1 004100421

415L

brocas helicoidais com veio cilíndrico, série longa, HSS-CO 5%, totalmente retificadas

R ≤ 1200 N/mm²
HV ~ 800÷860



DIN 340

Ø mm	L mm	L1 mm	€		
3,00	100	66	5,30	10	004150236
3,50	112	73	5,90	10	004150238
4,00	119	78	7,20	10	004150240
4,50	126	82	8,90	10	004150242
5,00	132	87	9,30	10	004150244
5,50	139	91	11,50	10	004150246
6,00	139	91	12,60	10	004150248
6,50	148	97	14,80	5	004150250
7,00	156	102	17,60	5	004150252
8,00	165	109	22,30	5	004150256
9,00	175	115	28,00	5	004150260
10,00	184	121	36,00	5	004150264

416

broca cilíndrica, para furar chão, com duas lâminas

R ≤ 900 N/mm²
HV || 820÷850



ALTA CAPACIDADE DE CORTE

DIN 338

Ø mm	L mm	L1 mm	€		
1,00	34	12	2,98	10	004160010
1,50	40	18	2,98	10	004160015
2,00	49	24	2,98	10	004160020
2,50	57	30	3,15	10	004160025
3,00	61	33	3,35	10	004160030
3,50	70	39	3,75	10	004160035
4,00	75	43	4,15	10	004160040
4,50	80	47	4,65	10	004160045
5,00	86	52	5,30	10	004160050
5,50	93	57	6,80	10	004160055
6,00	93	57	7,20	10	004160060
6,50	101	63	8,60	10	004160065
7,00	109	69	9,90	10	004160070
7,50	109	69	10,70	5	004160075
8,00	117	75	12,70	5	004160080
8,50	117	75	13,80	5	004160085
9,00	125	81	16,10	5	004160090
9,50	125	81	17,30	5	004160095
10,00	133	87	19,90	5	004160100



416/SP19	150,00	1	004160419
Ø 1÷10 x 0,5 mm			
410/SPVP1	29,00	1	004100421

416P/SP19

conjunto de 19 brocas cilíndricas, em HSS, AISI M2, com boca mais pequena para centragem de elevada precisão

Ø 1÷10 x 0,5 mm
MAIOR VELOCIDADE AO FURAR
R ≤ 900 N/mm²
HV ~ 820÷850

ALTA CAPACIDADE DE CORTE



416P/SP19	163,00	1	004160469
Ø 1÷10 x 0,5 mm			

115x170x40 mm

417

brocas cilíndricas para pedra, série curta em aço fresado, com ponta em diamante



DIN 8039

Ø mm	L mm	€		
3	70	3,95	10	004170003
4	75	3,95	10	004170004
5	85	4,20	10	004170005
5L	150	9,50	5	004170105
6	100	4,35	10	004170007
6L	150	9,50	5	004170106
7	120	4,90	10	004170009
8	120	5,40	10	004170010
8L	200	10,30	5	004170113
9	120	6,20	10	004170011
10	120	7,20	10	004170012
10L	200	12,40	5	004170120
12	150	9,40	10	004170014
12L	200	13,50	5	004170125
14	150	13,00	5	004170016
16	150	16,10	5	004170018



417/SP8	60,50	1	004170100
Ø 3-4-5-6-8-9-10-12 mm			

419

brocas para pedra, corpo fresado com ponta em diamante

HVA~ 1650



Ø mm	L mm	€		
4	110	8,20	10	004190002
5	110	8,20	10	004190004
5	160	9,10	10	004190006
6	110	8,10	10	004190012
6	160	8,90	10	004190014
6	210	11,80	10	004190016
7	160	9,80	10	004190028
8	110	8,70	10	004190030
8	160	9,40	10	004190032
8	210	11,30	10	004190034
8	260	15,30	10	004190036
8	310	18,80	10	004190038
8	460	34,50	10	004190042
9	160	11,50	5	004190044
10	160	11,80	5	004190050
10	210	13,70	5	004190052
10	260	17,10	5	004190054
10	310	23,90	5	004190056
10	460	37,50	5	004190060
12	160	13,10	5	004190064
12	210	17,80	5	004190066
12	260	19,10	5	004190068
12	460	39,50	5	004190074
14	160	18,10	3	004190086
14	260	21,80	3	004190090
14	310	31,00	3	004190092
14	460	40,50	3	004190096
16	210	27,00	3	004190112
16	260	28,50	3	004190114
16	310	34,50	3	004190116
16	460	45,50	3	004190120
18	260	36,50	1	004190124
20	310	36,50	1	004190128



419/SP7	84,00	1	004190507
Ø 5 - 6 - 8 x 110 mm			
Ø 6 - 8 - 10 - 12 x 160 mm			





419T

brocas SDS Plus com veio retificado, com 4 espirais e 4 cortantes

HVA~ 1650

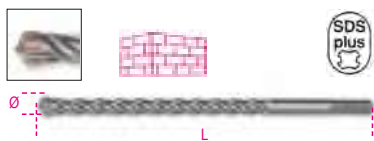

Ø mm	L mm	€		
5	110	5,60	5	004190604
5	160	6,30	5	004190606
6	110	5,90	5	004190612
6	160	6,90	5	004190614
6	210	9,40	5	004190616
7	160	7,00	5	004190628
8	110	6,40	5	004190630
8	160	7,20	5	004190632
8	210	9,60	5	004190634
8	260	10,90	5	004190636
8	310	13,50	5	004190638
9	160	7,70	3	004190644
10	160	7,70	3	004190650
10	210	10,30	3	004190652
10	260	11,20	3	004190654
10	310	16,00	3	004190656
10	460	21,60	3	004190660
12	160	8,70	3	004190664
12	210	11,30	3	004190666
12	260	11,90	3	004190668
12	460	22,30	3	004190674
14	160	11,70	2	004190686
14	260	13,70	2	004190690
14	310	19,30	2	004190692
14	460	21,60	2	004190696
16	210	15,50	2	004190712
16	260	20,50	2	004190714
16	310	22,20	2	004190716
16	460	22,90	2	004190720
18	260	25,00	1	004190724
20	310	30,50	1	004190728

421

Jogo de 6 escareadores com pino guia, qualidade superior, em HSS



DIN 373

M	L mm	Ø mm	D1 mm	D mm	€		
3	71	6	3,2	5	30,00	1	004210003
4	71	8	4,3	5	30,00	1	004210004
5	80	10	5,3	8	30,00	1	004210005
6	80	11	6,4	8	30,50	1	004210006
8	100	15	8,4	12,5	49,50	1	004210008
10	100	18	10,5	12,5	59,00	1	004210010
12	100	20	13,0	12,5	64,00	1	004210012



	€		
421/SP6 M 3-4-5-6-8-10	244,00	1	004210019
421/SPV	18,10	1	004210020

422

pontas de centrar, ângulo de escarear 60°, em HSS

• Para realizar furos de forma rápida e segura



DIN 333/A

Ø mm	D mm	L mm	€		
1,60	4,0	35,5	9,50	1	004220116
2,50	6,3	45,0	10,90	1	004220125
3,15	8,0	50,0	12,30	1	004220131

423

brocas especiais para soldadores em HSS - totalmente rectificadas



Ø mm	L mm	€		
6	66	18,80	5	004230006
7	74	22,90	5	004230007
8	79	25,00	5	004230008
10	89	29,50	5	004230010

423A

brocas especiais para soldadores com ponta guia de centragem em HSS - totalmente rectificadas



DIN 1412/E

Ø mm	L mm	€		
6,5	40	28,00	1	004230015
8,0	40	30,00	1	004230020

424

brocas cónicas para furar e alargar em HSS



L mm	Ø mm	D mm	€		
424/1	58	3÷14	6	35,00	2 004240001
424/2	63	6÷20	8	58,50	2 004240002
424/3	60	16÷30	10	100,00	2 004240003
424/4	80	3÷22	8	123,00	1 004240004
424/5	102	3÷31	10	165,00	1 004240005
424/6	86	26÷40	13	210,00	1 004240006
424/7	89	36÷50	13	314,00	1 004240007
424/8	90	40÷61	13	520,00	1 004240008



	€		
424/SP3 424/1+424/2+424/3 Ø 3÷30 mm	201,00	1	004240019
424/SPV	28,00	1	004240020

425

fresas cónicas de diâmetros múltiplos em HSS



L mm	Ø mm	S mm	D mm	€		
425/1	70	4÷12	1 6	59,00	2	004250010
425/2	55	4÷12	2 6	62,50	2	004250012
425/3	85	4÷20	2 10	90,50	2	004250015
425/4	85	12÷20	1 10	138,00	1	004250016
425/5	97	20÷30	1 10	271,00	1	004250017
425/6	75	4÷30	2 10	189,00	1	004250020
425/7	97	30÷40	1 13	377,00	1	004250025
425/8	100	40÷50	1 13	525,00	1	004250029



	€		
425/SP3 425/1+425/3+425/6 Ø 4÷30 mm	345,00	1	004250030
425/SPV	28,00	1	004250035

426

fresas para desbaste e aberturas em HSS, 3 lâminas



DIN 335-C

GR	Ø mm	L mm	Ø1 mm	€	🔧	🚚
1	4,3	44	4	19,70	3	004260001
2	5,3	44	4	19,70	3	004260002
3	6,3	44	5	20,50	3	004260003
4	7,3	44	6	24,00	3	004260004
5	8,3	50	6	24,00	3	004260005
6	9,4	50	6	27,00	3	004260006
7	10,4	54	6	30,00	3	004260007
8	12,4	54	8	32,00	3	004260008
9	15,0	56	10	36,50	3	004260009
10	16,5	60	10	38,50	3	004260010
11	20,5	63	10	53,00	3	004260011
12	25,0	66	10	84,00	3	004260012
13	28,0	71	12	113,00	3	004260013
14	31,0	71	12	120,00	3	004260014



DIN 335-C

426/SP6	€	🔧	🚚
GR 3-5-7-8-10-11 Ø 6,3÷20,5 mm	210,00	1	004260030
426/SPV	28,00	1	004260035

426A/SP6

conjunto de 6 escareadores, com 3 cortantes assimétricos em espiral, em HSS

Ø 6.3 - 8.3 - 10.4 - 12.4 - 16.5 - 20.5 mm



426A/SP6	€	🔧	🚚
Ø 6,3-8,3-10,4-12,4-16,5-20,5 mm	220,00	1	004260060
100x145x40 mm			

426T

escareadores para desbaste com três lâminas, HSS + TiN



DIN 335-C

GR	Ø mm	L mm	Ø1 mm	€	🔧	🚚
1	4,3	44	4	25,50	3	004260061
2	5,3	44	4	25,50	3	004260062
3	6,3	44	5	26,00	3	004260063
4	7,3	44	6	29,50	3	004260064
5	8,3	50	6	29,50	3	004260065
6	9,4	50	6	31,00	3	004260066
7	10,4	54	6	36,50	3	004260067
8	12,4	54	8	38,00	3	004260068
9	15,0	56	10	42,50	3	004260069
10	16,5	60	10	48,00	3	004260070
11	20,5	63	10	62,50	3	004260071
12	25,0	66	10	94,50	3	004260072
13	28,0	71	12	118,00	3	004260073
14	31,0	71	12	127,00	3	004260074



DIN 335-C

426T/SP6	€	🔧	🚚
GR 3-5-7-8-10-11 Ø 6,3÷20,5 mm	240,00	1	004260080
426/SPV	28,00	1	004260035

426SB

fresas para desbaste e vazar em HSS



GR	Ø mm	D mm	L mm	€	🔧	🚚
426/SB1	1 2÷5	6	45	26,50	1	004260101
426/SB2	2 5÷10	8	48	32,50	1	004260102
426/SB3	3 10÷15	10	65	59,00	1	004260103
426/SB4	4 15÷20	12	85	114,00	1	004260104
426/SB5	5 20÷25	15	102	191,00	1	004260105
426/SB6	6 25÷30	15	115	323,00	1	004260106



426SB/SP4	€	🔧	🚚
426/SB1-426/SB2 426/SB3-426/SB4 Ø 2÷20 mm	264,00	1	004260130
426SB/SPV1	28,00	1	004260135

426MD-3/CP3

Conjunto mini fresas rotativas em metal duro

• Corte transversal suave com quebras



L mm	Ø mm	€	🔧	🚚
38,1	3	14,50	1	004260332

426MD-3/CT3

Conjunto mini fresas rotativas em metal duro

• Corte transversal suave com quebras



L mm	Ø mm	€	🔧	🚚
37,8	3	14,50	1	004260333

426MD-3/F3

Conjunto mini fresas rotativas em metal duro

• Corte transversal suave com quebras



L mm	Ø mm	€	🔧	🚚
38,3	3	14,50	1	004260334

426MD-3/FA3

Conjunto mini fresas rotativas em metal duro

• Corte transversal suave com quebras



L mm	Ø mm	€	🔧	🚚
38,2	3	14,50	1	004260339

426MD-3/OG3

Conjunto mini fresas rotativas em metal duro

• Corte transversal suave com quebras

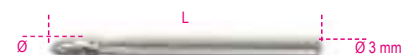

L mm	Ø mm	€	🔧	🚚
38,1	3	14,50	1	004260337

426MD-3/OV3

Conjunto mini fresas rotativas em metal duro

• Corte transversal suave com quebras



L mm	Ø mm	€	📦	📄
38,2	3	14,50	1	004260331

426MD-3/S3

Conjunto mini fresas rotativas em metal duro

• Corte transversal suave com quebras



L mm	Ø mm	€	📦	📄
38,0	3	14,50	1	004260338

426MD-3/T3

Conjunto mini fresas rotativas em metal duro

• Corte transversal suave com quebras



L mm	Ø mm	€	📦	📄
38,3	3	14,50	1	004260336

426MD-3/TA3

Conjunto mini fresas rotativas em metal duro

• Corte transversal suave com quebras



L mm	Ø mm	€	📦	📄
38,3	3	14,50	1	004260335



426MD-3/A9	€	📦	📄
131,00	1	004260349	
426MD-3/OV3 - 426MD-3/CP3			
426MD-3/CT3 - 426MD-3/F3			
426MD-3/TA3 - 426MD-3/T3			
426MD-3/OG3 - 426MD-3/S3			
426MD-3/FA3			

426MD/CP

limas rotativas, em metal endurecido

corte transversal HM4



L mm	Ø mm	€	📦	📄
50	6	40,50	1	004260532
63	8	44,50	1	004260512
63	9,5	50,50	1	004260542
69	12	71,00	1	004260522
69	16	102,00	1	004260552

426MD/CT

limas rotativas, em metal endurecido

corte transversal HM4



L mm	Ø mm	€	📦	📄
50	6	40,50	1	004260533
63	8	44,50	1	004260513
63	9,5	50,50	1	004260543
69	12	71,00	1	004260523
69	16	98,50	1	004260553

426MD/F

limas rotativas, em metal endurecido

corte transversal HM4



L mm	Ø mm	€	📦	📄
50	6	40,50	1	004260534
63	8	44,50	1	004260514
63	9,5	50,50	1	004260544
69	12	71,00	1	004260524
69	16	80,50	1	004260554

426MD/FA

limas rotativas, em metal endurecido

corte transversal HM4



L mm	Ø mm	€	📦	📄
50	6	40,50	1	004260539
63	8	44,50	1	004260519
63	9,5	50,50	1	004260549
69	12	71,00	1	004260529
69	16	91,50	1	004260559

426MD/OG

limas rotativas, em metal endurecido

corte transversal HM4

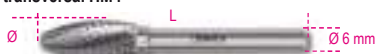

L mm	Ø mm	€	📦	📄
50	6	40,50	1	004260537
63	8	44,50	1	004260517
70	10	50,50	1	004260547
76	12	71,00	1	004260527
81	16	102,00	1	004260557

426MD/OV

limas rotativas, em metal endurecido

corte transversal HM4

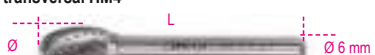

L mm	Ø mm	€	📦	📄
50	6	40,50	1	004260531
61	9,5	50,50	1	004260541
67	12	71,00	1	004260521
69	16	91,50	1	004260551

426MD/S

limas rotativas, em metal endurecido

corte transversal HM4



L mm	Ø mm	€	📦	📄
50	6	40,50	1	004260538
51	8	44,50	1	004260518
53	9,5	50,50	1	004260548
56	12	71,00	1	004260528
59	16	80,50	1	004260558

426MD/T

limas rotativas, em metal endurecido

corte transversal HM4



L mm	Ø mm	€	📦	📄
50	6	40,50	1	004260536
63	8	44,50	1	004260516
63	9,5	50,50	1	004260546
69	12	71,00	1	004260526
70	16	80,50	1	004260556

426MD/TA

limas rotativas, em metal endurecido

corte transversal HM4

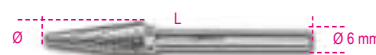

L mm	Ø mm	€	📦	📄
50	6	40,50	1	004260535
67	8	44,50	1	004260515
72	9,5	50,50	1	004260545
73	12	71,00	1	004260525
78	16	102,00	1	004260555



426MD/SP10	€	📦	📄
525,00	1	004260510	
426MD/CP-426MD/CT-426MD/F			
426MD/T-426MD/S			
Ø 8-12 mm			

427

extractores de cones Morse



DIN 317

GR	L mm	A mm	€	📦	🚚
0	92	13	14,10	3	004270000
1-2	140	19	19,90	3	004270002
3	190	25	23,90	3	004270003
4	225	30	40,50	3	004270004
5-6	260	35	74,00	3	004270006

428FP

machos mecânicos para furos vazantes
passo largo em HSS



ISO 529

M	■ mm	L mm	L1 mm	€	📦	🚚
3x0,5	2,7	56	11	19,20	10	004280003
4x0,7	3,4	63	13	19,20	10	004280004
5x0,8	4,9	70	16	19,20	10	004280005
6x1	4,9	80	19	20,20	10	004280006
8x1,25	6,2	90	22	24,50	10	004280008
10x1,5	8,0	100	24	29,00	10	004280010
12x1,75	7,0	110	29	37,50	5	004280012
14x2	9,0	110	30	46,00	5	004280014
16x2	9,0	110	30	55,50	5	004280016
18x2,5	11,0	125	34	71,00	3	004280018
20x2,5	12,0	140	34	80,00	3	004280020
22x2,5	14,5	140	34	96,00	3	004280022
24x3	14,5	160	38	105,00	3	004280024

428FC

machos mecânicos para furos cegos
passo largo em HSS



ISO 529

M	■ mm	L mm	L1 mm	€	📦	🚚
3x0,5	2,7	56	11	23,30	10	004280103
4x0,7	3,4	63	13	23,30	10	004280104
5x0,8	4,9	70	16	23,30	10	004280105
6x1	4,9	80	19	23,90	10	004280106
8x1,25	6,2	90	22	26,00	10	004280108
10x1,5	8,0	100	24	30,50	10	004280110
12x1,75	7,0	110	29	39,50	5	004280112
14x2	9,0	110	30	52,50	5	004280114
16x2	9,0	110	30	62,00	5	004280116
18x2,5	11,0	125	34	83,00	3	004280118
20x2,5	12,0	140	34	89,00	3	004280120
22x2,5	14,5	140	34	108,00	3	004280122
24x3	14,5	160	38	115,00	3	004280124

428/C14

jogo de 14 machos mecânicos
428FP+428FC



428/C14	€	📦	🚚
428FP M3÷12	418,00	1	004280201
428FC M3÷12			
428/SPV	24,50	1	004280202

429FP

machos mecânicos para furos vazantes
passo largo em HSS-CO 5%

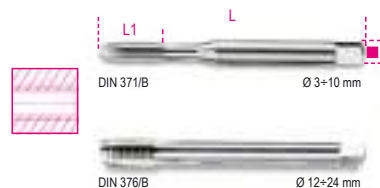

ISO 529

M	■ mm	L mm	L1 mm	€	📦	🚚
3x0,5	2,7	56	11	25,00	5	004290003
4x0,7	3,4	63	13	25,00	5	004290004
5x0,8	4,9	70	16	25,00	5	004290005
6x1	4,9	80	19	27,00	5	004290006
8x1,25	6,2	90	22	30,00	5	004290008
10x1,5	8,0	100	24	35,50	5	004290010
12x1,75	7,0	110	29	44,00	5	004290012
14x2	9,0	110	30	59,00	5	004290014

429FC

machos mecânicos para furos cegos
passo largo em HSS-CO 5%



ISO 529

M	■ mm	L mm	L1 mm	€	📦	🚚
3x0,5	2,7	56	11	30,50	5	004290103
4x0,7	3,4	63	13	30,50	5	004290104
5x0,8	4,9	70	16	30,50	5	004290105
6x1	4,9	80	19	32,00	5	004290106
8x1,25	6,2	90	22	36,00	5	004290108
10x1,5	8,0	100	24	43,00	5	004290110
12x1,75	7,0	110	29	52,50	5	004290112
14x2	9,0	110	30	69,00	5	004290114

429/C14

jogo de 14 machos mecânicos
429FP+429FC



429/C14	€	📦	🚚
429FP M3÷12	515,00	1	004290201
429FC M3÷12			
428/SPV	24,50	1	004280202

430

machos manuais, passo largo
em aço ao crômio



DIN 352 UNI 4535

M	■ mm	L mm	L1 mm	€	📦	🚚
2x0,4	2,5	36	11	16,70	5	004300002
3x0,5	2,5	40	12	11,80	5	004300003
4x0,7	3,0	45	14	11,80	5	004300004
5x0,8	4,0	48	16	12,30	5	004300005
6x1	5,0	50	18	12,40	5	004300006
7x1	4,5	50	18	15,90	5	004300007
8x1,25	5,0	56	22	16,00	3	004300008
9x1,25	5,5	63	22	21,60	3	004300009
10x1,5	6,0	70	25	20,50	3	004300010
11x1,5	7,0	70	25	26,50	3	004300011
12x1,75	7,0	75	30	26,50	3	004300012
14x2	8,0	80	32	33,50	3	004300014
16x2	10,0	80	32	39,50	3	004300016
18x2,5	11,0	95	40	52,50	1	004300018
20x2,5	12,0	95	40	63,00	1	004300020
22x2,5	14,5	100	40	76,50	1	004300022
24x3	14,5	110	50	90,50	1	004300024



430/SP21	€	📦	🚚
M 3-4-5-6-8-10-12	142,00	1	004300201
430/SPV	29,50	1	004300202

430ASW

machos manuais rosca Whitworth em aço ao cromo



DIN 352

BSW	mm	L mm	L1 mm	€	Hand	Computer
1/8x40	2,7	40	12	11,60	5	004300031
5/32x32	3,4	45	14	11,60	5	004300032
3/16x24	4,3	48	18	11,60	5	004300033
1/4x20	4,9	50	22	13,60	5	004300034
5/16x18	4,9	56	25	16,40	3	004300035
3/8x16	5,5	70	28	21,60	3	004300036
7/16x14	6,2	70	30	24,50	3	004300037
1/2x12	7,0	75	32	27,50	3	004300038
9/16x12	9,0	80	32	33,50	1	004300039
5/8x11	9,0	80	38	40,00	1	004300040
3/4x10	11,0	95	40	58,00	1	004300041
7/8x9	14,5	100	40	72,50	1	004300042
1"x8	16,0	110	50	94,00	1	004300043

430ASC

machos manuais rosca UNC em aço ao cromo



ANSI B1.1

UNC	mm	L mm	L1 mm	€	Hand	Computer
1/4x20	4,9	70	30	17,30	5	004300051
5/16x18	4,9	70	30	22,30	5	004300052
3/8x16	5,5	75	35	25,00	3	004300053
7/16x14	6,2	80	40	32,50	3	004300054
1/2x13	7,0	85	45	41,00	3	004300055
9/16x12	9,0	90	45	50,50	3	004300056
5/8x11	9,0	100	47	58,00	3	004300057
3/4x10	11,0	110	50	78,00	3	004300058
7/8x9	14,5	120	60	90,00	1	004300059
1"x8	16,0	130	60	102,00	1	004300060

431

machos manuais, passo largo em HSS



DIN 352 UNI 4535

M	mm	L mm	L1 mm	€	Hand	Computer
3x0,5	2,5	40	12	22,30	5	004310003
4x0,7	3,0	45	14	22,30	5	004310004
5x0,8	4,0	48	16	22,90	5	004310005
6x1	5,0	50	18	22,90	5	004310006
7x1	5,0	50	18	30,50	5	004310007

M	mm	L mm	L1 mm	€	Hand	Computer
8x1,25	5,0	56	22	28,00	3	004310008
10x1,5	6,0	70	25	34,50	3	004310010
12x1,75	7,0	75	30	52,00	3	004310012
14x2	9,0	80	32	72,50	1	004310014
16x2	9,0	80	32	82,00	1	004310016
18x2,5	11,0	95	40	123,00	1	004310018
20x2,5	12,0	95	40	132,00	1	004310020
22x2,5	12,0	100	40	189,00	1	004310022
24x3	14,5	110	50	213,00	1	004310024



431/SP21	€	Hand	Computer
M 3-4-5-6-8-10-12	258,00	1	004310201
431/SPV	29,50	1	004310202

433

machos manuais, passo fino em aço ao cromo



DIN 2181 UNI 4535

M	mm	L mm	L1 mm	€	Hand	Computer
6x0,75	4,5	48	16	10,30	5	004330201
7x0,75	4,5	56	18	12,80	5	004330202
8x0,75	5,0	50	16	12,80	5	004330203
8x1	5,0	56	16	12,80	5	004330204
9x0,75	6,0	63	22	16,70	5	004330205
9x1	6,0	63	22	16,70	5	004330206
10x0,75	6,5	63	18	16,70	5	004330207
10x1	6,5	63	18	16,70	5	004330208
10x1,25	6,5	63	18	16,70	5	004330209
11x0,75	7,0	70	25	22,50	3	004330210
11x1	7,0	70	25	22,50	3	004330211
11x1,25	7,0	70	25	22,50	3	004330212
12x0,75	7,0	70	20	21,80	3	004330213
12x1	7,0	70	20	21,80	3	004330214
12x1,25	7,0	70	20	21,80	3	004330215
12x1,5	7,0	70	20	21,80	3	004330216
14x1	8,0	80	32	29,00	1	004330217
14x1,25	8,0	80	32	29,00	1	004330218
14x1,5	8,0	80	32	29,00	1	004330219
16x1	10,0	80	32	34,00	1	004330220
16x1,5	10,0	80	32	34,00	1	004330221
18x1,5	11,0	95	40	40,00	1	004330222
18x2	11,0	80	25	52,00	1	004330223
20x1,5	14,5	80	22	59,00	1	004330224
22x1,5	14,5	80	22	70,50	1	004330225
24x1,5	14,5	80	22	82,00	1	004330226
24x2	14,5	80	22	81,50	1	004330227



433ASF

machos manuais, passo fino, rosca UNF em aço ao cromo



ANSI B1.1

UNF	mm	L mm	L1 mm	€	Hand	Computer
1/4x28	4,9	70	30	13,00	5	004330301
5/16x24	4,9	70	30	15,50	5	004330302
3/8x24	5,5	75	35	17,60	3	004330303
7/16x20	6,2	80	40	22,30	3	004330304
1/2x20	7,0	85	45	28,50	3	004330305
9/16x18	9,0	90	45	35,50	3	004330306
5/8x18	9,0	100	47	40,00	3	004330307
3/4x16	11,0	110	50	54,00	3	004330308
7/8x14	14,5	120	60	70,00	1	004330309
1"x12	16,0	130	60	95,50	1	004330310

433ASG

machos manuais rosca GAS cilíndrica em aço ao cromo



DIN 5157

GAS	mm	L mm	L1 mm	€	Hand	Computer
1/8x28	5,5	65	18	18,60	1	004330401
1/4x19	9,0	70	24	23,70	1	004330402
3/8x19	9,0	75	25	29,00	1	004330403
1/2x14	12,0	80	31	40,50	1	004330405
3/4x14	16,0	90	33	66,50	1	004330408
1"x11	20,0	100	39	108,00	1	004330410

434

machos manuais, passo fino em HSS



DIN 2181 UNI 4535

M	mm	L mm	L1 mm	€	Hand	Computer
6x0,75	4,5	48	16	29,50	5	004340001
8x0,75	5,0	56	16	34,50	5	004340003
8x1	5,0	56	16	34,50	5	004340004
10x0,75	6,5	63	18	43,00	5	004340007
10x1	6,5	63	18	43,00	5	004340008
10x1,25	6,5	63	18	43,00	5	004340009
12x1	7,0	70	20	46,50	3	004340014
12x1,25	7,0	70	20	46,50	3	004340015
12x1,5	7,0	70	20	46,50	3	004340016
13x1,5	9,0	70	20	97,50	1	004340017
14x1	9,0	70	20	58,00	1	004340018
14x1,25	9,0	70	20	58,00	1	004340019
14x1,5	9,0	70	20	49,50	1	004340020
15x1,5	9,0	70	20	97,50	1	004340021
16x1	9,0	70	20	62,50	1	004340022
16x1,5	9,0	70	20	53,50	1	004340023
18x1,5	11,0	80	22	69,50	1	004340024
18x2	11,0	90	25	84,00	1	004340025
20x1,25	12,0	80	22	119,00	1	004340026
20x1,5	12,0	80	22	74,00	1	004340027
20x2	12,0	90	25	91,50	1	004340028
22x1,5	14,5	80	22	106,00	1	004340029
24x1	14,5	80	22	142,00	1	004340030
24x1,5	14,5	80	22	119,00	1	004340031
24x2	14,5	80	22	125,00	1	004340032

435

desandadores de machos extensíveis
corpo em aço



DIN 1814

	□ mm	L mm	€		
435/0	2÷5 M1÷M8	170	20,00	3	004350007
435/1	2÷6 M1÷M10	200	24,00	2	004350009
435/1,5	2,5÷6 M1÷M12	200	25,50	2	004350011
435/2	3÷7 M4÷M12	260	36,00	2	004350013
435/3	4÷12 M5÷M20	345	60,00	1	004350020
435/4	5,5÷16 M9÷M27	430	93,50	1	004350027
435/5	7÷18 M13÷M32	770	211,00	1	004350032

435G

desandadores de machos extensíveis
corpo em liga leveira



DIN 1814

	□ mm	L mm	€		
435G/0	2÷5 M1÷M8	130	14,20	5	004350108
435G/1	2÷6 M1÷M10	190	17,40	5	004350110
435G/1,5	2÷7 M2÷M12	175	18,10	5	004350112
435G/2	3,4÷7 M4÷M12	280	30,00	5	004350114
435G/3	4,9÷12 M5÷M20	380	48,00	2	004350121
435G/4	7÷16 M11÷M27	500	76,50	2	004350127
435G/5	7÷18 M13÷M32	700	121,00	1	004350132
435G/6	11÷24 M18÷M42	800	199,00	1	004350142

436

punhos desandadores de machos
com roquete reversível

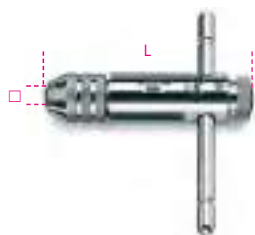

	□ mm	L mm	€		
436/1	2÷5 M3÷M8	85	33,50	5	004360002
436/2	4,6÷8 M5÷M12	110	42,00	5	004360004

436L

punhos desandadores de machos
com roquete reversível, tipo longo



	□ mm	L mm	€		
436L/1	2÷5 M3÷M8	245	52,50	2	004360012
436L/2	4,6÷8 M5÷M12	295	61,50	2	004360014

436R

buchas de substituição
para artigos 436 e 436L

	€		
436R/1	6,20	1	004360022
436R/2	7,00	1	004360024

437P

ferramenta para reparação de roscas internas,
externas, à direita e esquerda danificadas

P 0.80÷3.00 mm



L mm	€		
230	54,00	1	004370003

437C

jogo para reparação de roscas de velas de
ignição, M14x1.25 mm

• Altura helicoidal: 8.40 - 12.40 - 16.40 mm (5 pcs/tamanho)



437C	€		
	141,00	1	004370100

437C/...

helicóides em aço inoxidável para ref. 437C



H mm	€		
8.4	36,00	1	004370108
12.4	36,00	1	004370112
16.4	36,00	1	004370116

Os preços indicados são para 10 unidades

437C/RM14

macho para velas de ignição M14x1.25



437C/RM14	€		
	117,00	1	004370124

437K/8

kit reparação
de veios roscados

• Permite rectificar e corrigir a rosca original.
O kit inclui:
• tamanhos métricos:
20x1.25 - 20x1.5 - 22x1.00 - 22x1.5 - 24x1.5 - 24x2.00
• tamanhos polegadas:
3/4x20 - 13/16x20



32 mm

437K/8	€		
	93,00	1	004370020

200x110x30 mm

437K/9

Jogo de ferramentas para reparação de
roscas machos e fêmeas dos parafusos de
rodas

Permite que a rosca original seja reparada e retificada

Componentes do kit:
• Machos:
M12x1.25 - M12x1.5 - M12x1.75 - M14x1.5
• Caçonetes
M12x1.25 - M12x1.5 - M14x1.5



12 - 24 mm

437K/9	€		
	98,00	1	004370029

161x123x50 mm

437K/12

Jogo de ferramentas para reparação de veios roscados

Permite que a rosca original seja rectificada e preparada

Tamanhos incluídos:

• Sistema métrico:

M16x1.0 - M16x1.5 - M20x1.0 - M20x1.5 - M22x1.5 - M24x1.5 - M24x2.0 - M27x2.0

• Em polegadas (Inch):

3/4x16 - 3/4x20 - 13/16x20 - 27/32x20



∅ 32 - 35 mm

437K/12 € 117,00 1 004370032

≡ 220x118x52 mm

437K/16

jogo de ferramentas para reparação de fios danificados em pinças de travão M9x1.25



437K/16 € 131,00 1 004370016

≡ 210x150x50 mm

437K/33

jogo de ferramentas para reparação de fios de vela danificados

Casquilhos:

M8x1.0 - M10x1.0 - M10x1.25 - M12x1.25

Derivações:

M8x1.0 - M10x1.0 - M10x1.25 - M12x1.0 - M12x1.25 - M14x1.25



437K/33 € 325,00 1 004370133

≡ 210x150x50 mm

437U/09

Kit para reparação de roscas danificadas M5-M6-M8-M10-M12



25 x M5, M6, M8, M10
10 x M12

437U/09 € 393,00 1 004370550

M5X0,8
M6X1,0
M8X1,25
M10X1,5
M12X1,75

≡ 370x230x55 mm - 2 Kg

437U/E-M...

molas helicoidais em aço inoxidável



M	H mm	€	1	004370555
M5	7,5	21,00	1	004370555
M6	9	21,00	1	004370556
M8	12	29,00	1	004370558
M10	15	38,00	1	004370560
M12	18	23,90	1	004370562

Os preços referem-se a 25 unidades (10 para a medida M12)

437U/PM

bits e punções para ref. 437U/09



M	€	1	004370565
M5	39,50	1	004370565
M6	41,00	1	004370566
M8	55,50	1	004370568
M10	72,50	1	004370570
M12	90,50	1	004370572

438A

jogo de bits, para perfurar, roscar e escarear, HSS

• M3 - M4 - M5 - M6 - M8 - M10

• Com porta bits magnético



1/4
±0,05 S MAX mm = Ø mm



438A € 132,00 1 004380010

438...

bits para furar, roscar e escarear

HSS, encabadouro 1/4"

1/4



M	S max mm	€	2	004380103
M3	3	25,50	2	004380103
M4	4	25,50	2	004380104
M5	5	25,50	2	004380105
M6	6	25,50	2	004380106
M8	8	29,00	2	004380108
M10	10	29,00	2	004380110

440

caçonetos redondos, passo largo em aço ao cromo

R ≤ 600 N/mm²

HRC || 60+61

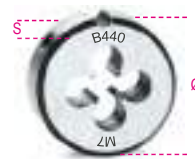

UNI 4535
DIN 223

M	Ø x S mm	€	5	004400002
2x0,4	25,4 x 9	20,10	5	004400002
3x0,5	25,4 x 9	14,80	5	004400003
4x0,7	25,4 x 9	14,80	5	004400004
5x0,8	25,4 x 9	12,70	5	004400005
6x1	25,4 x 9	12,70	5	004400006
7x1	25,4 x 9	12,70	5	004400007
8x1,25	25,4 x 9	12,70	5	004400008
9x1,25	25,4 x 9	12,70	5	004400009
10x1,5	25,4 x 9	12,70	5	004400010
12x1,75	25,4 x 9	12,70	5	004400012

440A

caçonetos redondos, passo largo em aço ao cromo

R ≤ 600 N/mm²

HRC || 60+61



UNI 4535
DIN 223

M	Ø x S mm	€	3	004400110
10x1,5	38,1 x 14	18,10	3	004400110
11x1,5	38,1 x 14	18,10	3	004400111
12x1,75	38,1 x 14	18,10	3	004400112
14x2	38,1 x 14	18,10	3	004400114
16x2	38,1 x 14	18,10	3	004400116
18x2,5	38,1 x 14	21,10	3	004400118
20x2,5	38,1 x 14	23,30	3	004400120

440B

caçonetos redondos, **passo largo**
em aço ao cromo

R ≤ 600 N/mm²
HRC || 60+61



UNI 4535
DIN 223

M	Ø x S mm	€		
18x2,5	50,8 x 16	32,00	3	004400122
20x2,5	50,8 x 16	34,00	3	004400124
22x2,5	50,8 x 16	36,50	3	004400126
24x3	50,8 x 16	37,00	3	004400128

440ASW

caçonetos redondos rosca **Whitworth**
em aço ao cromo

R ≤ 600 N/mm²



UNI EN 22568
DIN 223

BSW	Ø x S mm	€		
1/8x40	25,4 x 9	17,20	5	004400201
5/32x32	25,4 x 9	17,20	5	004400202
3/16x24	25,4 x 9	15,30	5	004400203
1/4x20	25,4 x 9	15,30	5	004400204
5/16x18	25,4 x 9	15,30	5	004400205
3/8x16	38,1 x 14	21,80	3	004400206
7/16x14	38,1 x 14	21,80	3	004400207
1/2x12	38,1 x 14	22,50	3	004400208
9/16x12	38,1 x 14	22,50	3	004400209
5/8x11	50,8 x 16	39,50	3	004400210
3/4x10	50,8 x 16	39,50	3	004400211
7/8x9	50,8 x 16	45,50	3	004400212
1"x8	50,8 x 16	45,50	3	004400213

440ASC

caçonetos redondos **passo largo**
rosca **UNC** em aço ao cromo

R ≤ 600 N/mm²



UNI EN 22568
DIN 223

UNC	Ø x S mm	€		
1/4x20	25,4 x 9	15,20	5	004400221
5/16x18	25,4 x 9	15,20	5	004400222
3/8x16	38,1 x 14	21,10	3	004400223
7/16x14	38,1 x 14	21,10	3	004400224
1/2x13	38,1 x 14	21,10	3	004400225
9/16x12	38,1 x 14	21,10	3	004400226
5/8x11	50,8 x 16	44,00	3	004400227
3/4x10	50,8 x 16	44,00	3	004400228
7/8x9	50,8 x 16	44,00	3	004400229
1"x8	50,8 x 16	44,00	3	004400230

440ASF

caçonetos redondos **passo fino**
rosca **UNF** em aço ao cromo

UNI EN 2258
DIN 223

UNF	Ø x S mm	€		
1/4x28	25,4 x 9	16,10	5	004400241
5/16x24	25,4 x 9	16,10	5	004400242
3/8x24	38,1 x 14	22,90	3	004400243
7/16x20	38,1 x 14	22,90	3	004400244
1/2x20	38,1 x 14	22,90	3	004400245
9/16x18	38,1 x 14	22,90	3	004400246
5/8x18	50,8 x 16	46,50	3	004400247
3/4x16	50,8 x 16	46,50	3	004400248
7/8x14	50,8 x 16	46,50	3	004400249
1"x12	50,8 x 16	46,50	3	004400250

440ASG

caçonetos redondos rosca **GAS**
cilíndrica em aço ao cromo

R ≤ 600 N/mm²



UNI EN 24231
DIN 223

GAS	Ø x S mm	€		
1/8x28	38,1 x 14	18,10	3	004400255
1/4x19	38,1 x 14	18,10	3	004400256
3/8x19	38,1 x 14	18,10	3	004400257
1/2x14	50,8 x 16	37,00	3	004400259
3/4x14	50,8 x 16	37,00	3	004400260
1"x11	63,5 x 19	72,50	3	004400261

441

caçonetos redondos, **passo fino**
em aço ao cromo

R ≤ 600 N/mm²
HRC || 60+61



UNI 4535
DIN 223

M	Ø x S mm	€		
6x0,75	25,4 x 9	15,30	5	004410004
7x0,75	25,4 x 9	15,30	5	004410005
8x0,75	25,4 x 9	15,30	5	004410006
8x1	25,4 x 9	15,30	5	004410007
9x0,75	25,4 x 9	15,30	5	004410008
9x1	25,4 x 9	15,30	5	004410009

441A

caçonetos redondos, **passo fino**
em aço ao cromo

R ≤ 600 N/mm²
HRC || 60+61



UNI 4535
DIN 223

M	Ø x S mm	€		
10x0,75	38,1 x 14	22,90	3	004410100
10x1	38,1 x 14	22,90	3	004410101
10x1,25	38,1 x 14	22,90	3	004410102
11x0,75	38,1 x 14	22,90	3	004410103
11x1	38,1 x 14	22,90	3	004410104
11x1,25	38,1 x 14	22,90	3	004410105
12x0,75	38,1 x 14	22,90	3	004410106
12x1	38,1 x 14	22,90	3	004410107
12x1,25	38,1 x 14	22,90	3	004410108
12x1,5	38,1 x 14	22,90	3	004410109
14x1	38,1 x 14	22,90	3	004410110
14x1,25	38,1 x 14	22,90	3	004410111
14x1,5	38,1 x 14	22,90	3	004410112
16x1	38,1 x 14	22,90	3	004410113
16x1,5	38,1 x 14	22,90	3	004410114
18x1,5	38,1 x 14	22,90	3	004410115

441B

caçonetos redondos, **passo fino**
em aço ao cromo

R ≤ 600 N/mm²
HRC || 60+61



UNI 4535
DIN 223

M	Ø x S mm	€		
18x1,5	50,8 x 16	42,50	3	004410117
18x2	50,8 x 16	42,50	3	004410118
20x1,5	50,8 x 16	43,00	3	004410119
22x1,5	50,8 x 16	45,50	3	004410120
24x1,5	50,8 x 16	46,00	3	004410121
24x2	50,8 x 16	46,00	3	004410122



442

caçonetos redondos, **passo largo**
em HSS

HRC || 62+63
AISI M2



UNI EN 22568
DIN 223

M	ØxS mm	€	🔧	📦
3x0,5	20x5	17,80	3	004420003
4x0,7	20x5	17,80	3	004420004
5x0,8	20x7	18,10	3	004420005
6x1	20x7	18,10	3	004420006
7x1	25x9	20,20	3	004420007
8x1,25	25x9	20,20	3	004420008
10x1,5	30x11	22,90	3	004420010
12x1,75	38x14	38,50	3	004420012
14x2	38x14	49,50	1	004420014
16x2	45x18	63,00	1	004420016
18x2,5	45x18	66,50	1	004420018
20x2,5	45x18	66,50	1	004420020

443

caçonetos redondos **passo fino**
rosca **UNF** em aço HSS

HRC || 62+63
AISI M2



UNI EN 22568
DIN 223

M	ØxS mm	€	🔧	📦
6x0,75	20x7	30,50	1	004430107
8x0,75	25x9	34,00	1	004430110
8x1	25x9	32,00	1	004430111
10x0,75	30x11	41,50	1	004430113
10x1	30x11	37,00	1	004430114
10x1,25	30x11	37,00	1	004430115
12x1	38x10	60,50	1	004430116
12x1,25	38x10	60,50	1	004430117
12x1,5	38x10	60,50	1	004430118
13x1,5	38x10	72,00	1	004430119
14x1	38x10	60,50	1	004430120
14x1,25	38x10	60,50	1	004430121
14x1,5	38x10	60,50	1	004430122
15x1,5	38x10	81,00	1	004430123
16x1	45x14	89,50	1	004430124
16x1,5	45x14	89,50	1	004430125
18x1,5	45x14	89,50	1	004430127
20x1,25	45x14	92,50	1	004430129
20x1,5	45x14	92,50	1	004430130
20x2	45x14	92,50	1	004430131
22x1,5	55x16	112,00	1	004430132
24x1	55x16	115,00	1	004430133
24x1,5	55x16	115,00	1	004430135
24x2	55x16	122,00	1	004430136

444

porta-caçonetos corpo em aço



EN 22568
DIN 225

	Ø mm	L mm	€	🔧	📦
444	20x5	190	24,10	5	004440005
444/0	20x7	190	24,10	5	004440007
444/1	25,4x9,5	210	25,00	5	004440025
444/1A	25x9	215	26,00	5	004440027
444/1B	30x11	250	30,00	5	004440030
444/C	38x10	310	38,00	3	004440033
444/1C	38x14	310	38,00	3	004440035
444/2	38,1x12,7	300	39,50	3	004440038
444/1D	45x14	445	53,50	1	004440045
444/2D	45x18	445	53,50	1	004440046
444/3	50,8x15,9	520	77,00	1	004440050
444/4	55x16	495	77,00	1	004440055
444/5A	63,5x19	520	133,00	1	004440057

444G

porta-caçonetos corpo em liga leve



UNI EN 22568
DIN 225

	Ø mm	L mm	€	🔧	📦
444G/A	16x5	160	11,40	5	004440103
444G	20x5	185	13,10	5	004440105
444G/0	20x7	185	13,10	5	004440107
444G/1	25,4x9,5	215	16,00	5	004440125
444G/1A	25x9	215	16,00	5	004440127
444G/1B	30x11	265	20,50	5	004440130
444G/C	38x10	315	30,00	3	004440133
444G/1C	38x14	315	30,00	3	004440135
444G/2	38,1x12,6	310	30,00	3	004440138
444G/1D	45x14	450	39,50	1	004440145
444G/2D	45x18	450	40,50	1	004440146
444G/3	50,8x16	485	42,00	1	004440150
444G/4	55x16	560	51,00	1	004440155
444G/5A	63,5x19	630	89,50	1	004440163
444G/6	65x18	630	95,00	1	004440165



446/C30

jogo de machos e caçonetos
em aço ao cromo e acessórios
rosca métrica em caixa de madeira



446/C30 € 368,00 1 004460055
325x220x35 mm - 3,2 Kg

430 M mm	440 M mm	435/1,5	444/1
3x0,5	3x0,5	4x0,7	4x0,7
5x0,8	5x0,8	6x1	6x1
8x1,25	8x1,25	10x1,5	10x1,5
12x1,75	12x1,75		

446/C48

jogo de machos e caçonetos
em aço ao cromo e acessórios
rosca métrica em caixa de madeira



446/C48 € 700,00 1 004460057
580x300x50 mm - 5 Kg

430 M mm	440 M mm	440A M mm	435/1	444/1
3x0,5	3x0,5	10x1,5	4x0,7	4x0,7
4x0,7	4x0,7	12x1,75	5x0,8	5x0,8
5x0,8	5x0,8	14x2	6x1	6x1
6x1	6x1	16x2	8x1,25	8x1,25
8x1,25	8x1,25	18x2,5	10x1,5	10x1,5
10x1,5		20x2,5	12x1,75	
12x1,75			14x2	
14x2			16x2	
16x2			18x2,5	
18x2,5			20x2,5	
20x2,5				

446/C110

jogo de machos e caçonetos em aço ao cromo e acessórios rosca métrica em caixa de madeira



446/C110 € 1.010,00 1 004460060

500x337x60 mm - 8,1 Kg

430 M	433 M	440/440A M	441/441A M
2x0,4	6x0,75	2x0,4	6x0,75
3x0,5	7x0,75	3x0,5	7x0,75
4x0,7	8x0,75	4x0,7	8x0,75
5x0,8	8x1	5x0,8	8x1
6x1	9x0,75	6x1	9x0,75
7x1	9x1	7x1	9x1
8x1,25	10x0,75	8x1,25	10x0,75
9x1,25	10x1	9x1,25	10x1
10x1,5	10x1,25	10x1,5	10x1,25
11x1,5	11x0,75	11x1,5	11x0,75
12x1,75	11x1	12x1,75	11x1
14x2	11x1,25	14x2	11x1,25
16x2	12x0,75	16x2	12x0,75
	12x1		12x1
	12x1,25		12x1,25
	12x1,5		12x1,5
	14x1		14x1
	14x1,25		14x1,25
	14x1,5		14x1,5
	16x1		16x1
	16x1,5		16x1,5
	18x1,5		18x1,5

435/0	444/1	436/1
435/3	444/2	

446ASF/C29

jogo de machos e caçonetos em aço ao cromo e acessórios rosca UNF em caixa de madeira



446ASF/C29 € 800,00 1 004460070

660x410x50 mm - 6 Kg

433ASF	440ASF		
1/4	1/4	435/1,5	444/1
5/16	5/16	435/3	444/2
3/8	3/8		444/3
7/16	7/16		
1/2	1/2		
9/16	9/16		
5/8	5/8		
3/4	3/4		

446ASW/C36

jogo de machos e caçonetos em aço ao cromo e acessórios rosca Whitworth em caixa de madeira



446ASW/C36 € 590,00 1 004460075

525x310x50 mm - 3,4 Kg

430ASW	440ASW		
1/8	1/8	435/1,5	444/1
5/32	5/32	435/2	444/2
3/16	3/16		
1/4	1/4		
5/16	5/16		
3/8	3/8		
7/16	7/16		
1/2	1/2		

446ASC/C37

jogo de machos e caçonetos em aço ao cromo e acessórios rosca UNC em caixa de madeira



446ASC/C37 € 855,00 1 004460080

660x410x50 mm - 6,7 Kg

430ASC	440ASC		
1/4	1/4	435/1,5	444/1
5/16	5/16	435/3	444/2
3/8	3/8		444/3
7/16	7/16		
1/2	1/2		
9/16	9/16		
5/8	5/8		
3/4	3/4		

446ASG/C23

jogo de machos e caçonetos em aço ao cromo e acessórios rosca GAS cilíndrica em caixa de madeira



446ASG/C23 € 1.250,00 1 004460085

700x430x70 mm - 9,8 Kg

430ASG	440ASG		
1/8	1/8	435/3	444/2
1/4	1/4	435/5	444/3
3/8	3/8		444/5A
1/2	1/2		
3/4	3/4		
1"	1"		

Beta

447/C37

jogo de machos e caçonetos em HSS e acessórios
rosca métrica em caixa de metálica



447/C37 € 745,00 1 004470055

≡ 380x185x35 mm - 3,9 Kg

431 M mm	442 M mm		
3x0,5	3x0,5	435/0	444
4x0,7	4x0,7	435/2	444/0
5x0,8	5x0,8		444/1A
6x1	6x1		444/1B
8x1,25	8x1,25		444/1C
10x1,5	10x1,5		
12x1,75	12x1,75		

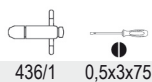

436/1 0,5x3x75

447/C53

jogo de machos e caçonetos em HSS e acessórios
rosca métrica em caixa de metálica



447/C53 € 1.550,00 1 004470060

≡ 500x235x50 mm - 9 Kg

431 M mm	442 M mm			
3x0,5	3x0,5	435/1,5	444	436/1
4x0,7	4x0,7	435/3	444/0	436/2
5x0,8	5x0,8		444/1A	
6x1	6x1		444/1B	
8x1,25	8x1,25		444/1C	
10x1,5	10x1,5		444/2D	
12x1,75	12x1,75			
14x2	14x2			
16x2	16x2			
18x2,5	18x2,5			
20x2,5	20x2,5			

447/C70

jogo de machos e caçonetos em HSS e acessórios
rosca métrica em caixa de madeira



447/C70 € 1.950,00 1 004470065

≡ 510x340x70 mm - 7,5 Kg

431 M mm	434 M mm	442 M mm	443 M mm
3x0,5	8x1	3x0,5	8x1
4x0,7	10x1,25	4x0,7	10x1,25
5x0,8	12x1,25	5x0,8	12x1,25
6x1	12x1,5	6x1	12x1,5
7x1	14x1,25	7x1	14x1,25
8x1,25	14x1,5	8x1,25	14x1,5
10x1,5	16x1,5	10x1,5	16x1,5
12x1,75		12x1,75	
14x2		14x2	
16x2		16x2	



435/0	444	436/1
435/3	444/0	
	444/1A	
	444/1B	
	444/C	
	444/1C	
	444/1D	
	444/2D	

450

brocas craneanas, bimetá,
HSS-Co 8%

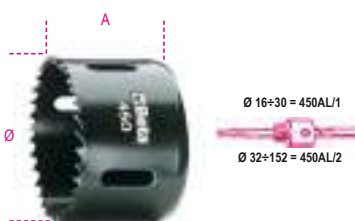

HSS-Co 8%

Ø mm	Ø	A mm	€		
16	(5/8)	57	19,70	1	004500016
17	(11/16)	57	19,70	1	004500017
19	(3/4)	51	19,70	1	004500019
20	-	51	19,70	1	004500020
21	(13/16)	51	19,70	1	004500021
22	(7/8)	51	19,70	1	004500022
24	(15/16)	51	19,70	1	004500024
25	(1")	51	21,60	1	004500025
27	(1 1/16)	51	22,40	1	004500027
29	(1 1/8)	51	22,40	1	004500029
30	(1 3/16)	51	22,40	1	004500030
32	(1 1/4)	51	22,40	1	004500032
33	(1 5/16)	51	22,90	1	004500033

Ø mm	Ø	A mm	€		
35	(1 3/8)	51	26,00	1	004500035
37	(1 7/16)	51	26,00	1	004500037
38	(1 1/2)	44	26,50	1	004500038
40	(1 9/16)	44	27,50	1	004500040
41	(1 5/8)	44	28,00	1	004500041
43	(1 11/16)	44	28,00	1	004500043
44	(1 3/4)	44	29,00	1	004500044
46	(1 13/16)	44	29,00	1	004500046
48	(1 7/8)	44	29,50	1	004500048
51	(2")	44	30,50	1	004500051
52	(2 1/16)	44	34,50	1	004500052
54	(2 1/8)	44	34,50	1	004500054
57	(2 1/4)	44	34,50	1	004500057
59	(2 5/16)	44	36,00	1	004500059
60	(2 3/8)	44	36,00	1	004500060
64	(2 1/2)	44	37,50	1	004500064
65	(2 9/16)	44	37,50	1	004500065
67	(2 5/8)	44	37,50	1	004500067
68	-	44	37,50	1	004500068
70	(2 3/4)	44	38,50	1	004500070
73	(2 7/8)	44	38,50	1	004500073
76	(3")	44	40,00	1	004500076
79	(3 1/8)	44	42,00	1	004500079
83	(3 1/4)	44	43,50	1	004500083
86	(3 3/8)	44	43,50	1	004500086
89	(3 1/2)	44	46,00	1	004500089
92	(3 5/8)	44	48,50	1	004500092
95	(3 3/4)	44	51,00	1	004500095
98	(3 7/8)	44	52,00	1	004500098
102	(4")	44	54,00	1	004500102
105	(4 1/8)	44	59,00	1	004500105
108	(4 1/4)	44	73,50	1	004500108
111	(4 3/8)	44	83,50	1	004500111
114	(4 1/2)	44	98,50	1	004500114
121	(4 3/4)	44	110,00	1	004500121
127	(5")	44	120,00	1	004500127
140	(5 1/2)	44	147,00	1	004500140
152	(6")	44	170,00	1	004500152

450AL

buchas para brocas craneanas

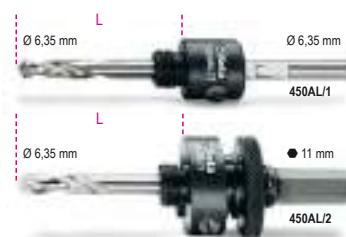

	Ø mm	L mm	€		
450AL/1	16±30	54	24,00	1	004500210
450AL/2	32±152	70	56,00	1	004500215

450AD

adaptador bucha/broca craneana 450AL/1



	Ø mm	€		
450AD	32=51	9,50	1	004500230



450PA/1

brocas para buchas em HSS
para 450AL/1



ØxL
mm
6,35x105 € 14,90 1 004500252

450PA/2

brocas para buchas em HSS
para 450AL/2

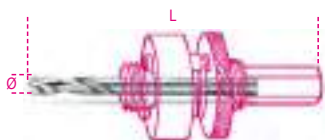

ØxL
mm
6,35x80 € 14,90 1 004500253

450PR

extensão para brocas cranianas



L
mm
305 € 40,50 1 004500255

450/C9

jogo de brocas cranianas e acessórios
para electricista



HSS-Co 8%

450/C9 € 285,00 1 004500305

450 Ø 22 - 29 - 35 - 44 - 51 - 64 mm
450AL /1 - /2
450AD
220x160x60 mm - 1,6 Kg

450/C13

jogo de brocas cranianas e acessórios
para instaladores



HSS-Co 8%

450/C13 € 357,00 1 004500310

450 Ø 19 - 22 - 29 - 35 - 38
44 - 51 - 57 - 64 mm
450AL /1 - /2
450PA/1
450AD
215x180x65 mm - 1,8 Kg

450/C15

Sortido de serras e acessórios para
eléctricistas



HSS-Co 8%

450/C15 € 466,00 1 004500313

450 Ø 16 - 20 - 25 - 32 - 40
51 - 60 - 65 - 70 mm
450AL /1 - /2
450PA /1 - /2
450PR
450AD
420x185x60 mm - 3,2 Kg

450/C21

jogo de brocas cranianas e acessórios
para uso industrial



HSS-Co 8%

450/C21 € 815,00 1 004500315

450 Ø 19 - 22 - 29 - 35 - 38
44 - 51 - 57 - 64 - 76
83 - 92 - 95 - 105 - 114 mm
450AL /1 - /2
450PA /1 - /2
450PR
450AD
420x280x60 mm - 7 Kg

451

fresa craniana em HSS
inteiramente rectificad

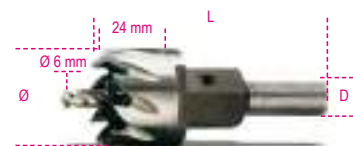

Ø mm	L mm	D mm	€	1	004510012
12	85	8	29,50	1	004510012
13	85	8	29,50	1	004510013
14	85	8	30,00	1	004510014
15	85	10	30,00	1	004510015
16	85	10	30,00	1	004510016
17	85	10	30,00	1	004510017
18	85	10	30,00	1	004510018
19	85	10	30,50	1	004510019
20	85	10	32,00	1	004510020
21	85	10	35,00	1	004510021
22	85	10	36,50	1	004510022
23	85	10	38,00	1	004510023
24	85	10	39,50	1	004510024
25	85	10	40,50	1	004510025
26	90	10	42,50	1	004510026
27	90	10	43,50	1	004510027
28	90	10	44,50	1	004510028
29	90	10	46,50	1	004510029
30	90	10	47,00	1	004510030
31	90	10	49,50	1	004510031
32	90	10	51,00	1	004510032
33	90	10	52,50	1	004510033
34	90	10	54,00	1	004510034
35	90	10	56,00	1	004510035
36	85	10	58,00	1	004510036
37	85	10	59,00	1	004510037
38	85	10	60,00	1	004510038
39	85	10	62,00	1	004510039
40	85	10	63,00	1	004510040
41	85	10	64,50	1	004510041
42	85	10	68,00	1	004510042
43	85	10	70,00	1	004510043
44	85	10	71,00	1	004510044
45	85	10	72,50	1	004510045
46	85	10	72,50	1	004510046
47	85	10	75,00	1	004510047
48	85	10	78,50	1	004510048
49	85	10	81,00	1	004510049
50	85	10	81,00	1	004510050

451/C

jogo de 8 fresas craneanas,
HSS,
inteiramente retificadas



451/C8	€ 379,00	1	004510308
Ø 16-18-20-22-25-30-32-35 mm			
≡ 270x225x70 mm			

451GA

bucha para fresa craneana artigo 451



M	Ø mm	L mm	D mm	€	1	004510101
10x1,25	12÷14	57	8	16,80	1	004510101
12x1,25	15÷34	57	10	16,80	1	004510102
14x1,5	35÷50	57	10	20,50	1	004510105

451PA

brocas para buchas 451 em HSS



Ø mm	L mm	€	1	004510103
6	53	9,50	1	004510103

451PR

extensão para fresa craneana artigo 451



M	Ø mm	L mm	Ø1 mm	€	1	004510104
12x1,25	15÷34	400	13	73,50	1	004510104
14x1,5	35÷50	400	13	73,50	1	004510108

Beta

452

fresa craneana com insertos
em metal duro

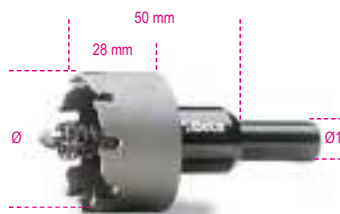

Ø mm	Ø1 mm	€	1	004520015
15	10	121,00	1	004520015
16	10	121,00	1	004520016
17	10	121,00	1	004520017
18	10	121,00	1	004520018
19	10	121,00	1	004520019
20	10	121,00	1	004520020
21	10	121,00	1	004520021
22	10	121,00	1	004520022
23	10	121,00	1	004520023
24	10	121,00	1	004520024
25	10	121,00	1	004520025
26	10	136,00	1	004520026
27	10	136,00	1	004520027
28	10	136,00	1	004520028
29	10	136,00	1	004520029
30	10	136,00	1	004520030
31	10	164,00	1	004520031
32	10	164,00	1	004520032
33	10	164,00	1	004520033
34	10	164,00	1	004520034
35	10	164,00	1	004520035
36	10	190,00	1	004520036
37	10	190,00	1	004520037
38	10	190,00	1	004520038
39	13	190,00	1	004520039
40	13	190,00	1	004520040
41	13	215,00	1	004520041
42	13	215,00	1	004520042
43	13	215,00	1	004520043
44	13	215,00	1	004520044
45	13	215,00	1	004520045
46	13	241,00	1	004520046
47	13	241,00	1	004520047
48	13	241,00	1	004520048
49	13	241,00	1	004520049
50	13	241,00	1	004520050
55	13	274,00	1	004520055
60	13	363,00	1	004520060
65	13	363,00	1	004520065
70	13	423,00	1	004520070
75	13	462,00	1	004520075
80	13	505,00	1	004520080
85	13	565,00	1	004520085
90	13	600,00	1	004520090

452GA

bucha para fresa craneana 452



	Ø mm	€	1	004520125
452GA/1	15÷21	15,00	1	004520125
452GA/2	22÷38	17,50	1	004520126
452GA/3	39÷100	20,90	1	004520127

460

fresa craneana para materiais de construção

- Para betão, cimento, pedra natural e artificial
- Profundidade máxima de perfuração: 60 mm



Ø mm	L mm	Z	€	1	004600050
50	75	6	62,00	1	004600050
60	75	6	73,50	1	004600060
65	75	6	76,50	1	004600065
80	75	6	114,00	1	004600080
90	75	6	120,00	1	004600090
100	75	8	148,00	1	004600100
112	75	8	169,00	1	004600112
125	80	10	210,00	1	004600125
150	80	12	283,00	1	004600150

460PP

broca piloto para fresa craneana para
materiais de construção (referência 460)



Ø mm	L mm	€	1	004600201
8	120	7,00	1	004600201

460G

adaptador para fresa craneana (referência 460)



L mm	€	1	004600222
220	38,00	1	004600222
370	53,00	1	004600237
460	84,00	1	004600246

MULTIPLICADORES DE BINÁRIO

Os multiplicadores de binário são ferramentas essenciais para o aperto de porcas e parafusos, uma vez que permitem um binário superior ao que o operador conseguiria aplicar em espaços confinados ou de difícil acesso. Não necessitam de extensões volumosas, garantindo total segurança. A gama de multiplicadores de binário Beta proporciona uma variedade de soluções e capacidades **até 9500 Nm**, e rácios de multiplicação de binário até 125:1. Muitos modelos, particularmente os mais potentes, estão equipados com sistema antirretorno de duplo sentido, para prevenir retornos de tensão perigosos para o operador. Cada multiplicador de binário Beta é acompanhado de um certificado de teste que comprova que a ferramenta foi testada ao valor máximo sob ótimas condições de trabalho.

Instruções de utilização

O multiplicador de binário deve ser usado com uma chave dinamométrica para assegurar o controlo do binário de saída; adicionalmente, deve ser sempre utilizado com chaves de impacto.

Os rácios de cada multiplicador de binário determinam o **fator de multiplicação** entre o binário de entrada e o de saída. Exemplo: multiplicador de binário com rácio de 5:1. Aplicando um binário de entrada de 100 Nm, conforme programado na chave dinamométrica, resultará num binário de saída de 500 Nm para a porca ou parafuso.

Contudo, assegure-se de que todos os componentes envolvidos no aperto estão corretamente alinhados.

Evite a utilização de **extensões**. Estas girariam, produzindo assim um efeito de mola que iria modificar os valores de binário aplicados.

Garanta sempre que o **braço de reação** do multiplicador de binário está fixo ou apoiado numa estrutura robusta, capaz de suportar a força de reação. Por norma recorre-se a paredes rígidas ou parafusos próximos do que vai ser objeto de aperto. O braço de reação roda sempre na direção oposta à direção de aperto.

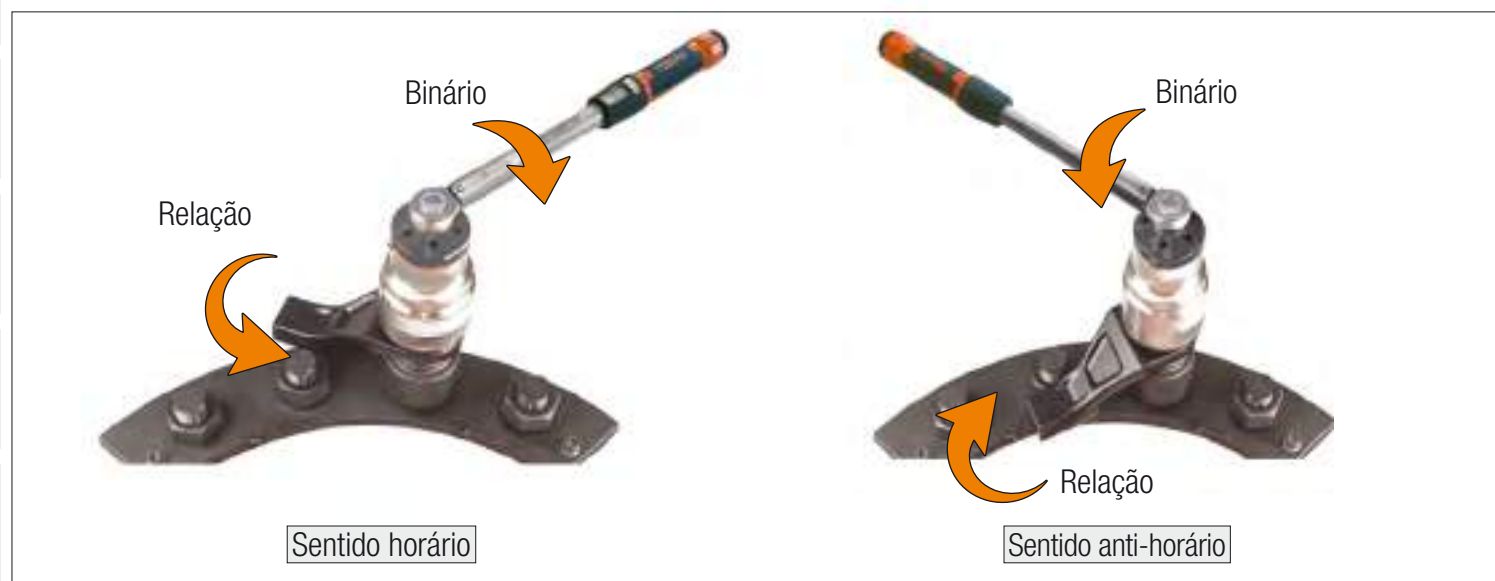

Realize a operação de forma suave e ininterrupta.

A tensão de aperto deve ser aliviada rodando o multiplicador de binário noutra direção, ou seja, desengatando-o; se o multiplicador possuir o sistema antirretorno, a tensão de aperto deve ser aliviada através da alavanca de inversão.

As instruções acima também se aplicam a operações de **desaperto**.

560/C3

multiplicador de binário para aperto à direita e esquerda, em estojo de plástico relação 3.8:1

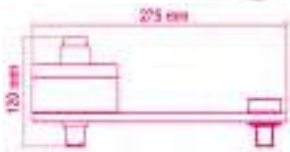

Nm	kgfm	lbf.ft	□	■	kg
1500	150	1110	1/2"	3/4"	3,9

	€		
560/C3	995,00	1	005600030

≡ 400x260x110 mm

560/C3PLUS

multiplicador de binário para aperto à direita e esquerda, em estojo de plástico relação 3.8:1



Nm	kgfm	lbf.ft	□	■	kg
2700	270	1991	3/4"	1"	7,5

	€		
560/C3PLUS	1.160,00	1	005600038

≡ 470x240x160 mm

560/C2

multiplicador de binário para aperto à esquerda e à direita, com acessórios relação 5:1 em caixa plástica para utilização intensiva

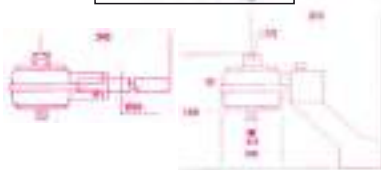

Nm	Kgfm	lbf.ft	□	■	kg
1300	130	960	1/2"	3/4"	3,8

	€		
560/C2	2.020,00	1	005600020
560/2	1.500,00	1	005600002
560/18	47,50	1	005600018
560/19	101,00	1	005600019
560/22	348,00	1	005600022

≡ 310x275x120 mm

560/C4+

multiplicador de binário para aperto à esquerda e à direita, com acessórios relação 5:1, com sistema antirretorno para utilização intensiva

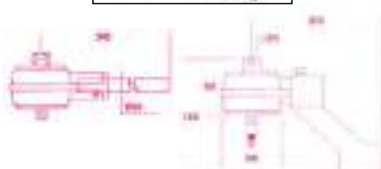

Nm	Kgfm	lbf.ft	□	■	kg
2700	270	2000	3/4"	1"	5

	€		
560/C4PLUS	1.980,00	1	005600042
560/4	1.570,00	1	005600004
560/18	47,50	1	005600018
560/22	348,00	1	005600022

≡ 310x275x120 mm

560/C6

Multiplicador de binário para aperto a esquerda e a direita em caixa plástica Relação: 6.5:1



Nm	kgfm	lbf.ft	□	■	kg
1500	150	1106	1/2"	3/4"	6

	€		
560/C6	1.040,00	1	005600160

≡ 400x260x110 mm

560/C12

Multiplicador de binário para aperto a esquerda e a direita em caixa plástica Relação: 12:1



Nm	kgfm	lbf.ft	□	■	kg
2500	250	1844	1/2"	1"	7

	€		
560/C12	1.490,00	1	005600210

≡ 400x260x110 mm

561/1

multiplicador de binário, relação 5:1 com duas uniões de reação

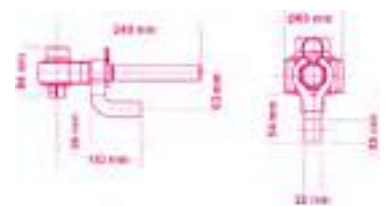

Nm	kgfm	lbf.ft	□	■	kg
1000	100	740	1/2"	3/4"	2,7

	€		
561/1	1.450,00	1	005610010

≡ 270x210x70 mm

562-1/VA - 562-2/VA

multiplicadores de binário para aperto à esquerda e à direita relação 5,2:1 em estojo 562VV-A



Nm	Kgfm	lbf.ft	□	■	D	A	L min	L max	█
1700	170	1250	3/4	1"	108	95	85	220	8,8

562-1/VA € 3.210,00 1 005620601

Nm	Kgfm	lbf.ft	□	■	D	A	L min	L max	█
3400	340	2500	3/4	1"	119	115	85	265	10,5

562-2/VA € 3.890,00 1 005620602

564-3R/V - 564-4R/V

multiplicadores de binário para aperto à esquerda e à direita

rácio 25:1 com sistema anti-retorno, em estojo



Nm	Kgfm	lbf.ft	□	■	D	A	L	█
4000	400	3000	1/2	1"	92	185	205	7,6

564-3R/V € 6.250,00 1 005640613

≡ 390x310x145 mm

Nm	Kgfm	lbf.ft	□	■	D	A	L	█
7000	700	5000	1/2	1 1/2"	120	200	210	13,2

564-4R/V € 7.400,00 1 005640614

≡ 500x435x170 mm

565-1R/VA - 565-2R/VA - 565-3R/VA

multiplicadores de binário para aperto à esquerda e à direita relação 27:1 com sistema anti-retorno, em estojo 562VV-A



Nm	Kgfm	lbf.ft	□	■	D	A	L min	L max	█
1700	170	1250	1/2	1"	108	125	80	215	11,2

565-1R/VA € 5.200,00 1 005650611

Nm	Kgfm	lbf.ft	□	■	D	A	L min	L max	█
3400	340	2500	1/2	1"	119	145	85	265	13,6

565-2R/VA € 6.800,00 1 005650612

Nm	Kgfm	lbf.ft	□	■	D	A	L min	L max	█
3400	340	2500	1/2	1 1/2"	119	145	85	265	14,2

565-3R/VA € 7.200,00 1 005650613

565-4R/VB

multiplicadores de binário para aperto à esquerda e à direita relação 27:1 com sistema anti-retorno, em estojo 565VV-B

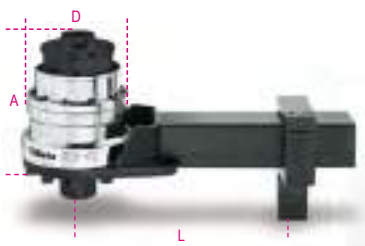

Nm	Kgfm	lbf.ft	□	■	D	A	L min	L max	█
6000	600	4500	1/2	1 1/2"	144	180	125	335	22,4

565-4R/VB € 8.100,00 1 005650614

565-5R/VB

multiplicadores de binário para aperto à esquerda e à direita relação 27:1 com sistema anti-retorno, em estojo 565VV-B

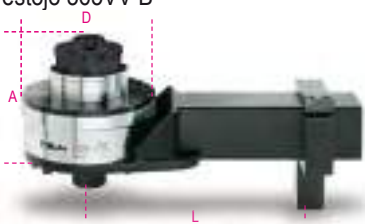

Nm	Kgfm	lbf.ft	□	■	D	A	L min	L max	█
9500	950	7000	3/4	1 1/2"	184	180	155	355	30,4

565-5R/VB € 13.800,00 1 005650615

567-4R/VB

multiplicadores de binário para aperto à esquerda e à direita relação 135:1 com sistema anti-retorno, em estojo 565VV-B

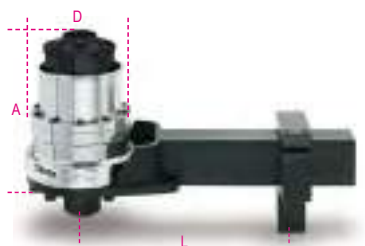

Nm	Kgfm	lbf.ft	□	■	D	A	L min	L max	█
6000	600	4500	1/2	1 1/2"	144	210	125	335	24,4

567-4R/VB € 9.000,00 1 005670614

567-5R/VB

multiplicadores de binário para aperto à esquerda e à direita relação 135:1 com sistema anti-retorno, em estojo 565VV-B

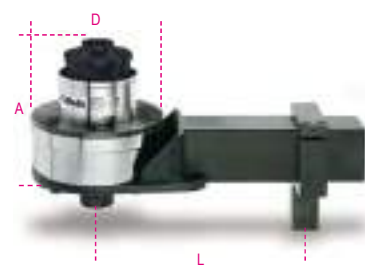

Nm	Kgfm	lbf.ft	□	■	D	A	L min	L max	█
9500	950	7000	1/2	1 1/2"	184	210	155	350	32,4

567-5R/VB € 15.500,00 1 005670615

562VV-A

caixa para multiplicador binário, em polipropileno resistente com revestimento interior em esponja Dimensão do interior: 380x270x180 mm



562VV-A € 275,00 1 005620501

562/1-562/2-564/3R
564/4R-565/1R-565/2R
565/3R

≡ 410x340x205 mm - █ 3,5 kg

565VV-B

caixa para multiplicador binário, em polipropileno resistente com revestimento interior em esponja dimensão do interior: 480x370x205 mm



565VV-B € 371,00 1 005650502

565/4R-565/5R
567/4R-567/5R

≡ 520x435x230 mm - █ 5,4 kg



As chaves dinamométricas devem ser sempre manuseadas de forma suave e ininterrupta, evitando movimentos bruscos e agarrando no meio do punho, de forma a não alterar o rácio da alavanca.



A escala de ajuste deve ser reposta a zero após a utilização para não afetar a precisão do aperto. Este procedimento não é necessário com as chaves Zero-Reset.



A Beta oferece uma ampla gama de chaves, com **quatro tipos de funcionamento distintos**.

MODELOS COM LEITURA DIRETA

A força de binário aplicada é diretamente transmitida para o índice de leitura através de compressão de uma mola helicoidal. O binário aplicado pode ser lido em tempo real através de um ponteiro. Um segundo ponteiro pode ser posicionado no valor de binário desejado. Quando esse valor é alcançado, o segundo ponteiro será imobilizado pelo ponteiro principal e é registado o valor máximo. As chaves dinamométricas de leitura direta asseguram uma precisão e durabilidade notáveis.

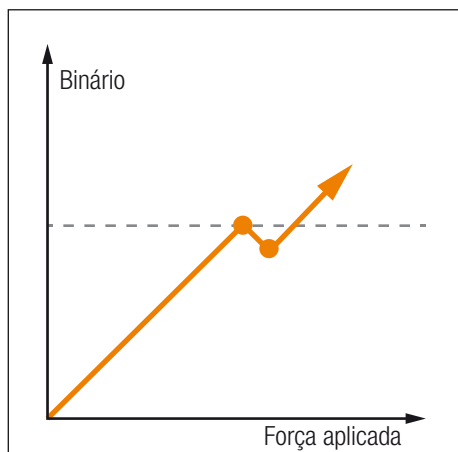

MODELOS COM DESARME SONORO

As chaves dinamométricas com desarme sonoro são as mais populares graças à sua facilidade de utilização. Permitem uma pré-seleção rápida através da mola e o valor do binário aumenta à medida que a força aplicada é ampliada. Quando o valor de binário desejado é alcançado, ocorre um desengate súbito e a chave não aplicará qualquer força por aproximadamente 3-5°. Se o operador não interromper o movimento, o aperto continuará a aumentar, excedendo assim os valores desejados.

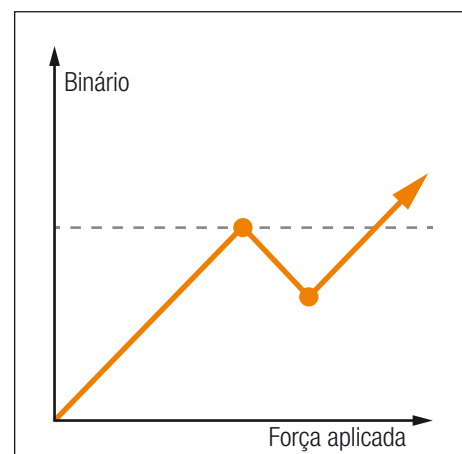

MODELOS COM EMBRAIAGEM

O funcionamento das chaves dinamométricas com embraiagem é idêntico ao das chaves com desarme sonoro, mas quando o valor de binário é alcançado, ocorre um desengate súbito do braço da alavanca (aprox. 20°). Assim, é mais fácil para o operador interromper a aplicação de força. Normalmente estas chaves são utilizadas para elevados valores de aperto com braços de alavanca muito longos.

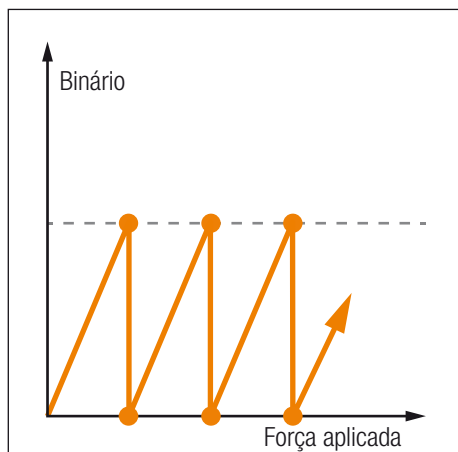

MODELOS COM EMBRAIAGEM DE SEGURANÇA

Quando é alcançado o valor de binário pré-estabelecido, o mecanismo de segurança impede a aplicação do aperto, provocando a imobilização da ferramenta. Isto evitará o aperto com valores acima dos desejados. A manutenção da força resultará na repetição do mesmo ciclo. Estas chaves são ideais para operações sequenciais com baixos valores de aperto (indústria eletrónica e micromecânica), em que é absolutamente prioritário evitar a quebra de componentes delicados ou de pequenas dimensões.

ÁREAS DE APLICAÇÃO DE CHAVES E BARRAS DINAMOMÉTRICAS

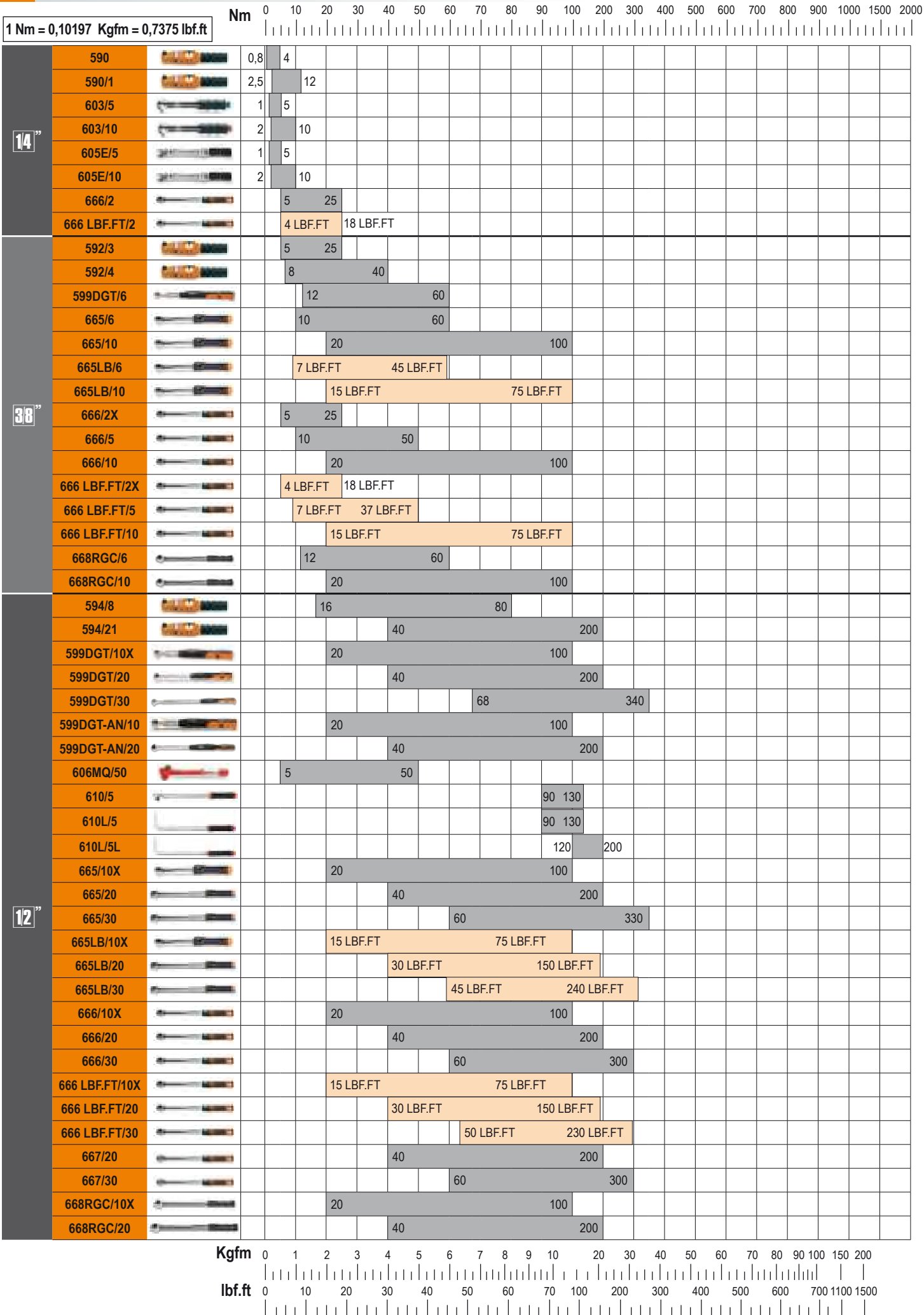

ÁREAS DE APLICAÇÃO DE CHAVES E BARRAS DINAMOMÉTRICAS

1 Nm = 0,10197 Kgfm = 0,7375 lbf.ft



3/4"	596/40SL									80		400									
	596/80SL										160		800								
	667/40									80		400									
	677/600 677C/600										120		600								
	677/800 677C/800										200		800								
	677/1000 677C/1000											300		1000							
	677C/1500												700	1500							
	678C/65											130		650							
	678C/100												300		1000						
	678C/150													500		1500					
1"	598/200SL												400		2000						
	677/CP2000														900	2000					
1/8"	604B/5		1	5																	
	604B/10		2	10																	
1/16"	668N/2			5	25																
	668N/5				10		50														
	668N/10					20		100													
	668N/20						40		200												
	668N/30							60		300											
	668RG/6			8			60														
	668RG/10				20			100													
	668RG/20					40			200												
	668RG/30						60			300											
9x12	669N/2			5	25																
	669N/5				10		50														
	669N/10					20		100													
	669N/20						40		200												
14x18	669N/20X						40		200												
	669N/30							60		300											
	669N/40								80		400										
22	674/C50									100		500									
	674/C80										160		800								
	674/C100											200		1000							



Cálculo do binário

O braço de alavanca muda para acessórios de comprimento diferente do standard ($LA \neq LS$). Para calcular o binário, utilize a seguinte fórmula:

$$C = \frac{M \cdot (L_B + L_S)}{L_B + L_A} [N \cdot m]$$

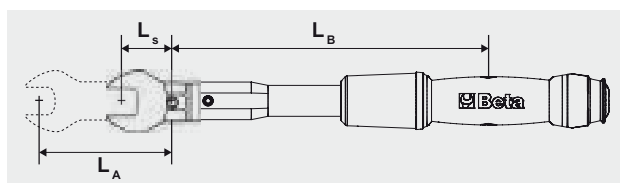

C = binário a programar

M = binário desejado

L_A = comprimento do acessório (consultar tabela de especificação de acessórios)

L_B = comprimento da barra (consultar tabela de especificação de binário)

L_S = comprimento standard do acessório (consultar tabela de especificação da barra de binário)

Beta

581

aparafusadora dinâmometrica não graduada para apertos à direita
precisão: ±6%
(para utilização com artigos 588 - 682)



UNI EN ISO 6789

Nm 1,2÷6 Kgf·m 120÷600 O 1/4" g 275

581 € 324,00 1 005810001

583

aparafusadora dinâmometrica graduada para apertos à direita
precisão: ±6%



UNI EN ISO 6789

Nm 0,3÷1,5 Kgf·m 30÷150 O 1/4" g 240 0,05

583/1,5 € 365,00 1 005830015

Nm 0,6÷3 Kgf·m 60÷300 O 1/4" g 240 0,1

583/3 € 365,00 1 005830030

Nm 1,2÷6 Kgf·m 120÷600 O 1/4" g 350 0,2

583/6 € 365,00 1 005830060

583/C31

1 aparafusadora dinâmometrica, 8 chaves de caixa manuais sextavadas, 20 bits e 2 acessórios

1/4"



583/C31 € 482,00 1 005830931

	583/6	1.2 - 6 Nm
	900	4-5-5,5-6-7-8-9-10 mm
	860LP	0,6x4,5 - 1x5,5 - 1,2x6,5 mm
	860PH	PH1 - PH2 (x2) - PH3
	860PE	2-2,5-3-4-5 mm
	860TX	T9-T10-T15-T20-T25-T27-T30-T40
	882P/80	80 mm
	892/0	● 1/4" ■ 1/4"

270x120x45 mm - 1,2 kg

590 - 592

chaves dinâmometricas de leitura directa para aperto direito e esquerdo
precisão: ±4%

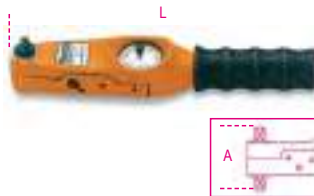

UNI EN ISO 6789

Nm 0,3÷4 Kgf·m 0,03÷0,4 lbf.in 3÷35 1/4" A mm 60 L mm 253 g 0,52 0,1

590 € 860,00 1 005900001

Nm 0,5÷13,5 Kgf·m 0,05÷1,35 lbf.in 4÷120 1/4" A mm 60 L mm 253 g 0,52 0,5

590/1 € 860,00 1 005900003

Nm 1÷27 Kgf·m 0,1÷2,7 lbf.in 10÷240 3/8" A mm 70 L mm 253 g 0,52 1,0

592/3 € 855,00 1 005920005

Nm 3÷40 Kgf·m 0,3÷4 lbf.in 20÷360 3/8" A mm 70 L mm 253 g 0,52 1,0

592/4 € 855,00 1 005920007

594

chaves dinâmometricas de leitura directa para aperto direito e esquerdo
precisão: ±4%

1/2"



UNI EN ISO 6789

Nm 6÷80 Kgf·m 0,6÷8 lbf.ft 5÷60 1/2" A mm 85 L mm 455 g 1,35 2,0

594/8 € 1.300,00 1 005940011

Nm 20÷215 Kgf·m 2÷21,5 lbf.ft 15÷160 1/2" A mm 85 L mm 530 g 1,40 5,0

594/21 € 1.300,00 1 005940015

Serviço de calibração de binário no final

596 - 598

chaves dinâmometricas de leitura directa para aperto direito e esquerdo
precisão: ±4%

Com avisadores luminosos e sonoros na medida pré-definida



UNI EN ISO 6789

Nm 80÷400 Kgf·m 8÷40 lbf.ft 60÷300 3/4" A mm 111 L mm 710 g 3,2 10

596/40SL € 2.140,00 1 005960010

Nm 160÷800 Kgf·m 16÷80 lbf.ft 120÷600 3/4" A mm 115 L mm 1025 g 4,85 20

596/80SL € 2.690,00 1 005960020

Nm 200÷2000 Kgf·m 20÷200 lbf.ft 150÷1500 1" A mm 135 L mm 1930 g 16,70 50

598/200SL € 5.650,00 1 005980022

Beta

UNIVERSAL TOOLS



599DGT

chave eletrônica
com roquete reversível,
aperto à direita (precisão: $\pm 2\%$) e à (esquerda
precisão: $\pm 3\%$)

- Modo de medição dupla: pico e curso
- Indicadores luminosos e acústicos informam o utilizador que o valor pré-selecionado foi atingido
- Alimentação: 2 pilhas 1.5V (incluídas)



UNI EN ISO 6789

Nm	Kgfm	lbf.ft	■	D	A	L	█	⚖
12÷60	1,2÷6	8÷44	3/8	30	33	413	0,9	0,1

599DGT/6	€ 455,00	1	005990003
-----------------	-----------------	----------	------------------

Nm	Kgfm	lbf.ft	■	D	A	L	█	⚖
20÷100	2÷10	15÷80	1/2	30	37	413	0,9	0,1

599DGT/10X	€ 468,00	1	005990010
-------------------	-----------------	----------	------------------

Nm	Kgfm	lbf.ft	■	D	A	L	█	⚖
40÷200	4÷20	30÷150	1/2	40	43	520	2	0,1

599DGT/20	€ 487,00	1	005990020
------------------	-----------------	----------	------------------

Nm	Kgfm	lbf.ft	■	D	A	L	█	⚖
68÷340	6,8÷34	58÷280	1/2	40	43	640	2,35	0,1

599DGT/30	€ 525,00	1	005990030
------------------	-----------------	----------	------------------

599DGT-AN

chave dinamométrica eletrônica, leitura do
binário e ângulo,
com roquete reversível,
para aperto à direita (precisão: $\pm 2\%$)
e à esquerda (precisão: $\pm 3\%$)

- tipos de aperto: binário, ângulo, binário + ângulo
- modo de medição duplo: pico e curso
- indicador luminoso e sinal acústico informam o utilizador que o valor pré-selecionado foi atingido
- armazenamento de dados (até 250 valores)
- predefinição até 9 valores binário/ângulo
- bloqueio de segurança
- permite inserir 16 utilizadores diferentes através da ID de utilizador
- rastreabilidade de dados. O software permite armazenar e associar à ID de utilizador a data e hora, número de série da ferramenta, valor de aperto definido e valor alcançado
- punho de dois componentes antiderrapante
- inclui: 2 pilhas AA - 1.5V, cabo USB e software



UNI EN 26789
ISO 6789

Nm	Kgfm	lbf.ft	■	D	A	L	█	⚖
20÷100	2÷10	15÷80	1/2	30	33	413	0,9	0,1

599DGT-AN/10	€ 855,00	1	005990610
---------------------	-----------------	----------	------------------

Nm	Kgfm	lbf.ft	■	D	A	L	█	⚖
40÷200	4÷20	30÷150	1/2	40	43	520	1,3	0,1

599DGT-AN/20	€ 905,00	1	005990620
---------------------	-----------------	----------	------------------

Serviço de calibração de binário no final



600

chaves de aperto angular

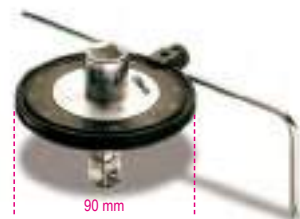

	□	■	€	⚖	⌨
600/1	1/2	1/2	183,00	1	006000001
600/2	3/4	3/4	207,00	1	006000002

601C

indicador digital ângulo de aperto

Indicador luminoso e um sinal sonoro informam o utilizador que o ângulo programado já foi alcançado



601C	€ 245,00	1	006010100
85x80x87 mm - █ 70 g			

601CA

indicador digital ângulo e binário de aperto

Indicador luminoso e um sinal sonoro informam o utilizador que o ângulo programado já foi alcançado



□	■	Nm	⚖	€	⚖	⌨
1/2"	1/2"	40÷200	0,1	433,00	1	006010120
120x90x120 mm - █ 240 g						

603

chaves dinamométricas
com embraiagem de segurança
para aperto à direita
precisão: $\pm 6\%$



UNI EN ISO 6789

Nm	Kgfm	lbf.in	■	A	L	g	📏
1÷5	0,1÷0,5	10÷45	1/4	35	195	235	0,05

603/5 € 740,00 1 006030005

Nm	Kgfm	lbf.in	■	A	L	g	📏
2÷10	0,2÷1,0	18÷90	1/4	35	195	235	0,1

603/10 € 755,00 1 006030010

604B

barra dinamométrica
para aperto à direita e à esquerda
precisão de aperto: $\pm 6\%$



UNI EN ISO 6789

Nm	kgfm	lbf.in	∅	L	g	📏
1÷5	0,1÷0,5	10÷45	8	220	290	0,025

604B/5 € 479,00 1 006040015

Nm	Kgfm	lbf.in	∅	L	g	📏
2÷10	0,2÷1,0	18÷90	8	220	300	0,05

604B/10 € 479,00 1 006040020

605E

chaves dinamométricas com desarme sonoro,
roquete reversível
de aperto à direita e à esquerda
precisão: $\pm 6\%$



UNI EN ISO 6789

Nm	Kgfm	lbf.in	■	A	L	g	📏
1÷5	0,1÷0,5	10÷45	1/4	20	190	180	0,05

605E/5 € 246,00 1 006050105

Nm	Kgfm	lbf.in	■	A	L	g	📏
2÷10	0,2÷1,0	18÷90	1/4	20	190	180	0,1

605E/10 € 257,00 1 006050110

605DGT/2

chave dinamométrica eletrônica
com roquete reversível
para aperto à direita/esquerda
precisão $\pm 3\%$ (à direita)
 $\pm 4\%$ (à esquerda)

- Modo de medição duplo: pico e curso
- Indicador luminoso e sinal acústico informam o utilizador de que o valor pré-selecionado foi atingido
- Alimentação: 1 pilha 1.5V AAA (incluída)



Nm	Kgcm	lbf.ft	■	D	A	L	g	📏
4÷20	10÷204	0,75÷14,75	1/4	20	20	210	175	0,01

605DGT/2 € 295,00 1 006050302

610/5

chaves dinamométricas
com roquetes reversíveis,
para aperto à direita,
com 5 valores programados,
precisão de aperto: $\pm 4\%$

Valores de aperto disponíveis:
90 - 100 - 110 - 120 - 130 Nm

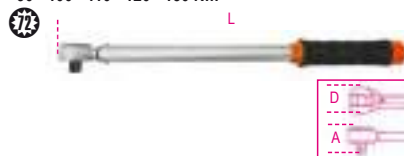

UNI EN ISO 6789

Nm	■	D	A	L	g	📏
90÷130	1/2	42	39	490	1330	10

610/5 € 205,00 1 006100025

610L/5

chaves dinamométricas
com alavanca em L para apertos à direita,
com 5 valores programados,
precisão de aperto: $\pm 4\%$

Valores de aperto disponíveis:
90 - 100 - 110 - 120 - 130 Nm



UNI EN ISO 6789

Nm	■	L	L1	g	📏
90÷130	1/2	470	80	1350	10

610L/5 € 183,00 1 006100125

610L/5L

chave dinamométrica
com alavanca em L,
para apertos à direita,
com 5 valores pré-regulados,
precisão de aperto: $\pm 4\%$

Valores de aperto selecionáveis:
120 - 140 - 160 - 180 - 200 Nm



UNI EN ISO 6789

Nm	■	L	L1	g	📏
120÷200	1/2	470	80	1400	20

610L/5L € 188,00 1 006100150

611

roquete reversível
para barras dinamométricas refs. 604B/5 e
604B/10
encabadouro 8 mm



■	L	€	📏
1/4	42,5	173,00	1 006110001

Serviço de calibração de binário no final

612 ÷ 614

roquetes reversíveis para barras
dinamométricas



As referências 612 e 612X não podem ser usados em apertos cujo torque exceda 100 Nm

	■	L	LA	€	📏
612	3/8	66	32	77,50	2 006120000
612X	1/2	66	32	82,00	2 006120010
614	1/2	71	32	89,50	2 006140000
614X	3/4	71	32	98,00	2 006140004

614/50

roquete simples para barras
dinamométricas



614/50	mm	L mm	LA mm	€	Unidade	Artigo
1/2	71	32		82,00	2	006140002

Ver quadro depois do artigo 929/C8
para acessórios compatíveis usados

615

roquete reversível
para barras dinamométricas,
encabadouro rectangular



mm	mm	L mm	LA mm	€	Unidade	Artigo
9x12	3/8	53	28,8	65,50	1	006150010
9x12	1/2	53	28,8	65,50	1	006150020
14x18	1/2	70	39,8	65,50	1	006150120

616 - 617 - 619

quadras macho para barras
dinamométricas



616	mm	L mm	LA mm	€	Unidade	Artigo
1/4	61	32		61,50	1	006160000
3/8	61	32		61,50	1	006170000
1/2	63	32		61,50	1	006190000

621

calha porta ponteiras
para barras dinamométricas,
encabadouro rectangular



621P	mm	L mm	LA mm	€	Unidade	Artigo
1/4	9x12	14	43 28,8	78,00	1	006210000
* 621P	5/16	14x18	5/16 52,5 32,5	120,00	1	006210110

*Atenção! Recalcular o valor do binário conforme
indicado na tabela que se encontra no fim do catálogo

622

roquetes reversíveis
para barras dinamométricas,
encabadouro redondo, Ø 22 mm



622	mm	L mm	LA mm	€	Unidade	Artigo
3/4	110	56		218,00	1	006220019
1"	110	56		265,00	1	006220024

641

ponteira de boca
para barras dinamométricas refs. 604B/5 e
604B/10
encabadouro 8 mm



641	mm	L mm	€	Unidade	Artigo
4	37		93,00	1	006410003
5	37		93,00	1	006410004
5,5	37		93,00	1	006410005
6	37		93,00	1	006410006
7	37		93,00	1	006410007
8	42		93,00	1	006410008
9	42		93,00	1	006410009
10	42		93,00	1	006410010

642

ponteiras boca para barras
dinamométricas



642	mm	L mm	LA mm	A mm	€	Unidade	Artigo
8	54	32	22		66,00	1	006420008
10	57	32	26		66,00	1	006420010
12	58	32	30		66,00	1	006420012
13	58	32	30		66,00	1	006420013
14	59	32	32		66,00	1	006420014
15	59	32	35		66,00	1	006420015
16	59	32	38		66,00	1	006420016
17	60	32	39		66,00	1	006420017
18	61	32	42		66,00	1	006420018
19	61	32	43		66,00	1	006420019
20	61	32	50		103,00	1	006420020
21	62	32	53		103,00	1	006420021
22	62	32	53		113,00	1	006420022
23	65	32	53		113,00	1	006420023
24	63	32	53		113,00	1	006420024
25	64	32	53		138,00	1	006420125
26	64	32	59		138,00	1	006420026
27	65	32	59		138,00	1	006420027
28	66	32	64		138,00	1	006420028
30	66	32	66		138,00	1	006420030
32	67	32	66		138,00	1	006420032
* 36	76	42	80		189,00	1	006420036
* 40	77	52	95		189,00	1	006420040
* 41	78	52	95		189,00	1	006420041
* 46	90	52	95		227,00	1	006420046

*Atenção! Recalcular o valor do binário conforme
indicado na tabela que se encontra no fim do catálogo

643

ponteiras de boca
para barras de aperto,
encabadouro rectangular



643	mm	L mm	LA mm	€	Unidade	Artigo
7	9x12	37	28,8	58,00	1	006430007
8	9x12	37	28,8	58,00	1	006430008
10	9x12	39	28,8	58,00	1	006430010
12	9x12	39	28,8	58,00	1	006430012
13	9x12	39	28,8	58,00	1	006430013
14	9x12	43	28,8	58,50	1	006430014
15	9x12	43	28,8	58,50	1	006430015
16	9x12	43	28,8	58,50	1	006430016
17	9x12	43	28,8	58,50	1	006430017
* 18	9x12	47	36,3	58,50	1	006430018
* 19	9x12	51	36,3	58,50	1	006430019
* 21	9x12	52	36,3	90,50	1	006430021
* 22	9x12	52	36,3	90,50	1	006430022

*Atenção! Recalcular o valor do binário conforme
indicado na tabela que se encontra no fim do catálogo

643	mm	L mm	LA mm	€	Unidade	Artigo
13	14x18	60	39,8	60,50	1	006430113
14	14x18	58	39,8	60,50	1	006430114
15	14x18	60	39,8	60,50	1	006430115
16	14x18	60	39,8	61,50	1	006430116
17	14x18	60	39,8	61,50	1	006430117
18	14x18	61	39,8	61,50	1	006430118
19	14x18	61	39,8	61,50	1	006430119
21	14x18	61	39,8	95,50	1	006430121
22	14x18	62	39,8	95,50	1	006430122
24	14x18	64	39,8	95,50	1	006430124
* 27	14x18	68	44,8	108,00	1	006430127
* 30	14x18	77	49,8	109,00	1	006430130
* 32	14x18	77	49,8	109,00	1	006430132
* 34	14x18	80	54,8	173,00	1	006430134
* 36	14x18	83	54,8	173,00	1	006430136
* 38	14x18	83	54,8	173,00	1	006430138
* 41	14x18	91	64,8	173,00	1	006430141

*Atenção! Recalcular o valor do binário conforme
indicado na tabela que se encontra no fim do catálogo

644

ponteiras de boca
para barras dinamométricas,
encabadouro redondo, Ø 22 mm



644	mm	L mm	LA mm	A mm	€	Unidade	Artigo
22	91	56	52		113,00	1	006440022
24	91	56	52		113,00	1	006440024
27	94	56	64		138,00	1	006440027
30	94	56	64		138,00	1	006440030
32	97	56	75,5		138,00	1	006440032
34	97	56	75,5		138,00	1	006440034
36	97	56	75,5		189,00	1	006440036
41	103,5	56	94		189,00	1	006440041
46	115,5	56	94		227,00	1	006440046

650A

Chaves de abertura variável para barras dinamométricas, encabadouro rectangular



A min-max mm	mm	L mm	LA mm	€		
* 5-27	9x12	93	74,3	106,00	1	006500027
* 5-30	9x12	106	85,3	106,00	1	006500030
* 5-30	14x18	115	89	108,00	1	006500130
* 10-41	14x18	127	100	112,00	1	006500141

650H

Chaves de unha para barras dinamométricas, encabadouro rectangular



mm	mm	L mm	LA mm	€		
* 28-36	14x18	122	92	56,50	1	006500928
* 40-45	14x18	129	92	56,50	1	006500940
* 50-55	14x18	129	92	56,50	1	006500950
* 58-62	14x18	135	92	59,50	1	006500958
* 68-75	14x18	139	92	65,00	1	006500968
* 80-90	14x18	145	92	65,00	1	006500980

652

ponteiras de luneta para barras dinamométricas



mm	L mm	LA mm	€		
8	58	32	71,50	1	006520008
10	58	32	71,50	1	006520010
12	58	32	71,50	1	006520012
13	58	32	71,50	1	006520013
14	58	32	71,50	1	006520014
15	62	32	71,50	1	006520015
16	63	32	71,50	1	006520016
17	64	32	71,50	1	006520017
18	65	32	71,50	1	006520018
19	65	32	71,50	1	006520019
21	67	32	108,00	1	006520021
22	68	32	114,00	1	006520022
24	69	32	136,00	1	006520024
26	71	32	153,00	1	006520026
27	71	32	153,00	1	006520027
30	73	32	153,00	1	006520030
32	74	32	153,00	1	006520032

653

ponteiras de luneta para barras de aperto, encabadouro rectangular



mm	mm	L mm	LA mm	€		
7	9x12	40	28,8	62,00	1	006530007
8	9x12	40	28,8	62,00	1	006530008
10	9x12	43	28,8	62,00	1	006530010
12	9x12	44	28,8	62,00	1	006530012
13	9x12	44	28,8	62,00	1	006530013
14	9x12	45	28,8	62,00	1	006530014
15	9x12	46	28,8	62,00	1	006530015
16	9x12	47	28,8	62,50	1	006530016
17	9x12	47	28,8	62,50	1	006530017
18	9x12	48	28,8	62,50	1	006530018
19	9x12	49	28,8	62,50	1	006530019
21	9x12	51	28,8	65,00	1	006530021
22	9x12	51	28,8	65,00	1	006530022

mm	mm	L mm	LA mm	€		
13	14x18	61	39,8	68,50	1	006530113
14	14x18	61	39,8	68,50	1	006530114
15	14x18	62	39,8	68,50	1	006530115
16	14x18	63	39,8	69,00	1	006530116
17	14x18	64	39,8	69,00	1	006530117
18	14x18	64	39,8	69,00	1	006530118
19	14x18	66	39,8	69,00	1	006530119
21	14x18	66	39,8	99,50	1	006530121
22	14x18	67	39,8	99,50	1	006530122
24	14x18	69	39,8	124,00	1	006530124
* 27	14x18	76	44,8	124,00	1	006530127
* 30	14x18	77	44,8	124,00	1	006530130
* 32	14x18	79	44,8	124,00	1	006530132
* 34	14x18	80	44,8	176,00	1	006530134
* 36	14x18	80	44,8	176,00	1	006530136
* 38	14x18	90	49,8	180,00	1	006530138
* 41	14x18	90	49,8	180,00	1	006530141

*Atenção! Recalcular o valor do binário conforme indicado na tabela que se encontra no fim do catálogo

654

chaves de luneta para barras dinamométricas, encabadouro, Ø 22 mm



mm	L mm	LA mm	A mm	€		
22	98,5	56	38	114,00	1	006540022
24	98,5	56	38	136,00	1	006540024
27	102,8	56	46,5	153,00	1	006540027
30	102,8	56	46,5	153,00	1	006540030
32	106,5	56	55	153,00	1	006540032
34	106,5	56	55	153,00	1	006540034
36	106,5	56	55	199,00	1	006540036
41	115,5	56	72	199,00	1	006540041
46	115,5	56	72	216,00	1	006540046

659/15

adaptador com quadra rectangular fêmea (14x18 mm) e macho (9x12 mm)



L mm	mm	mm	LA mm	€		
* 56	14x18	9x12	39	90,00	1	006590815

*Atenção! Recalcular o valor do binário conforme indicado na tabela que se encontra no fim do catálogo



Aplique sempre uma força de aperto regular e progressiva, a fim de evitar a ruptura do material e de se proteger de um possível acidente

659/16

adaptador com quadra rectangular fêmea (9x12 mm) e macho (14x18 mm)



L mm	mm	mm	LA mm	€		
* 52	9x12	14x18	31	76,50	1	006590816

*Atenção! Recalcular o valor do binário conforme indicado na tabela que se encontra no fim do catálogo

665

Chave dinamométrica mecânica com leitura digital e roquete reversível, para aperto à direita, precisão: $\pm 3\%$

- Desliga automaticamente após 10" com aperto min. selecionado
- O ecrã pisca quando atinge o aperto máximo
- O ecrã mante-se ligado com o valor do aperto definido
- Leitura de aperto 0,1%
- Alimentação: 1 pilha de 3v (incluída)



CE

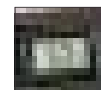

UNI EN ISO 6789

Nm	mm	D mm	A mm	L mm	g	
10=60	3/8	30	33	335	655	0,1

€		
665/6	273,00	1 006650006

Nm	mm	D mm	A mm	L mm	g	
20=100	3/8	30	33	375	725	0,1

€		
665/10	275,00	1 006650010

Nm	mm	D mm	A mm	L mm	g	
20=100	1/2	30	37	375	725	0,1

€		
665/10X	281,00	1 006650011

Nm	mm	D mm	A mm	L mm	g	
40=200	1/2	40	43	470	995	0,5

€		
665/20	299,00	1 006650020

Nm	mm	D mm	A mm	L mm	g	
60=330	1/2	40	43	590	1260	0,5

€		
665/30	339,00	1 006650030

665LB

chave dinamométrica mecânica com leitura digital e roquete reversível, para aperto à direita, precisão: $\pm 3\%$

- Unidade de medida: lbf.ft
- Ajuste e leitura fácil do binário através do valor exibido no ecrã
- Leitura de aperto até 0.1 mm
- Desliga automaticamente após 30 seg. com aperto mínimo selecionado
- Alimentação: 1 pilha 3V (incluída)

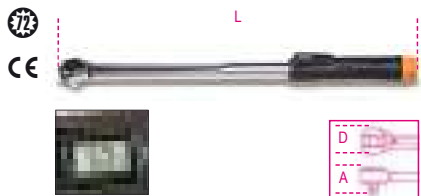

UNI EN ISO 6789

lbf.ft	■	D mm	A mm	L mm	g	⚙️
7÷45	3/8	30	33	335	655	0,1

665LB/6 € 273,00 1 006650106

lbf.ft	■	D mm	A mm	L mm	g	⚙️
15÷75	3/8	30	33	375	725	0,1

665LB/10 € 275,00 1 006650110

lbf.ft	■	D mm	A mm	L mm	g	⚙️
15÷75	1/2	30	37	375	725	0,1

665LB/10X € 281,00 1 006650111

lbf.ft	■	D mm	A mm	L mm	g	⚙️
30÷150	1/2	40	43	470	995	0,5

665LB/20 € 299,00 1 006650120

lbf.ft	■	D mm	A mm	L mm	g	⚙️
45÷240	1/2	40	43	590	1260	0,5

665LB/30 € 339,00 1 006650130

665SW

dispositivo de calibragem

- O dispositivo permite a calibragem das chaves dinamométricas 665 com a ajuda dos controladores eletrónicos de binário 680 e 682, sem necessidade de desmontar a chave.
- A calibragem é realizada em vários pontos, para compensar o comportamento não linear da mola.
- Equipado com entrada micro USB, para atualizações de firmware.



665SW € 27,50 1 006650100

666-667 ZERO-RESET

A NOVA CHAVE DINAMOMÉTRICA QUE NÃO REQUER LIBERTAÇÃO DE TENSÃO.

Mesmo que a tensão não seja libertada, o número de ciclos, durabilidade e precisão de aperto exigidos pelas normas de referência são garantidos. Para confirmar estes parâmetros, o Departamento de Pesquisa e Desenvolvimento da Beta Utensili realizou vários testes de resistência nos seus laboratórios e em centenas de utilizadores finais. Este resultado foi obtido através de:

- utilização dos materiais com melhor desempenho atualmente disponíveis;
- tratamento térmico especial nos componentes internos

FABRICO 100% ITALIANO

A chave dinamométrica Zero Reset foi totalmente desenvolvida internamente e é produzida nas fábricas da Beta Utensili em Itália, utilizando peças 100% italianas.

Graças aos novos componentes, a chave não precisa de ser restaurada ao valor mínimo após a utilização.

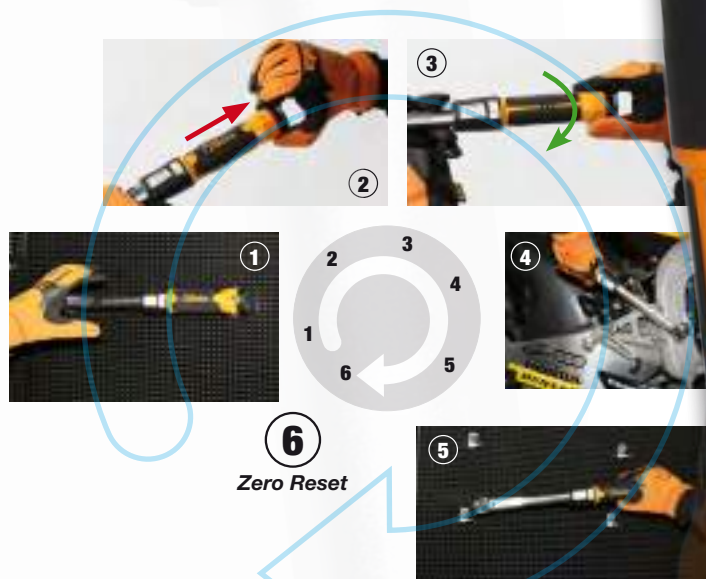

6
Zero Reset

666

chaves dinamométricas ZERO-RESET com roquetes reversíveis, para aperto à direita, precisão de torque: $\pm 3\%$

• Não é necessário libertar a tensão



UNI EN ISO 6789

Nm	■	D mm	A mm	L mm	g	📏
5÷25	1/4	26	25	273	395	0,05

666/2 300,00 1 006660702

Nm	■	D mm	A mm	L mm	g	📏
5÷25	3/8	26	29	273	405	0,05

666/2X 300,00 1 006660703

Nm	■	D mm	A mm	L mm	g	📏
10÷50	3/8	30	33	342	680	0,25

666/5 273,00 1 006660705

Nm	■	D mm	A mm	L mm	g	📏
20÷100	3/8	30	33	385	760	0,25

666/10 275,00 1 006660710

Nm	■	D mm	A mm	L mm	g	📏
20÷100	1/2	30	37	385	770	0,25

666/10X 281,00 1 006660711

Nm	■	D mm	A mm	L mm	g	📏
40÷200	1/2	42	43	471	1020	0,5

666/20 299,00 1 006660720

Nm	■	D mm	A mm	L mm	g	📏
60÷300	1/2	42	43	600	1270	1,0

666/30 339,00 1 006660730

666 LBF.FT

chaves dinamométricas ZERO-RESET com roquetes reversíveis, para aperto à direita, precisão de torque: $\pm 3\%$

• Não é necessário libertar a tensão
• Escala em lbf.ft



UNI EN ISO 6789

lbf.ft	■	D mm	A mm	L mm	g	📏
4÷18	1/4	26	25	273	395	0,05

666 LBF.FT/2 284,00 1 006660762

lbf.ft	■	D mm	A mm	L mm	g	📏
4÷18	3/8	26	29	273	405	0,05

666 LBF.FT/2X 284,00 1 006660763

lbf.ft	■	D mm	A mm	L mm	g	📏
7÷37	3/8	30	33	342	680	0,25

666 LBF.FT/5 258,00 1 006660765

lbf.ft	■	D mm	A mm	L mm	g	📏
15÷75	3/8	30	33	385	760	0,25

666 LBF.FT/10 260,00 1 006660780

lbf.ft	■	D mm	A mm	L mm	g	📏
15÷75	1/2	30	37	385	770	0,25

666 LBF.FT/10X 265,00 1 006660781

lbf.ft	■	D mm	A mm	L mm	g	📏
30÷150	1/2	42	43	471	1020	0,5

666 LBF.FT/20 283,00 1 006660782

lbf.ft	■	D mm	A mm	L mm	g	📏
50÷230	1/2	42	43	600	1270	1,0

666 LBF.FT/30 321,00 1 006660783

667

chave dinamométrica ZERO-RESET com roquete reversível, para aperto à direita/esquerda, precisão de torque: $\pm 3\%$

• Não requer libertação de tensão



UNI EN ISO 6789

Nm	■	D mm	A mm	L mm	g	📏
40÷200	1/2	42	42	471	1035	0,5

667/20 294,00 1 006670720

Nm	■	D mm	A mm	L mm	g	📏
60÷300	1/2	42	42	600	1285	1,0

667/30 327,00 1 006670730

Nm	■	D mm	A mm	L mm	g	📏
80÷400	3/4	59	53	710	2220	1,0

667/40 790,00 1 006670740

Ver quadro depois do artigo 929/C8 para acessórios compatíveis usados

668N

barras de aperto, para operações à esquerda e à direita, precisão de torque: $\pm 3\%$

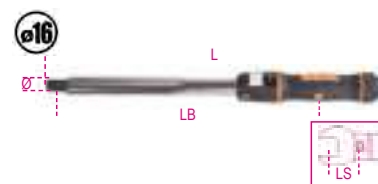

UNI EN ISO 6789

Nm	Kgfm	lbf.ft	Ø mm	L mm	LB mm	LS mm	g	📏
5÷25	0,5÷2,5	4÷18	16	220	148	32	300	0,2

668N/2 275,00 1 006680002

Nm	Kgfm	lbf.ft	Ø mm	L mm	LB mm	LS mm	g	📏
10÷50	1÷5	7÷37	16	307	229	32	590	0,5

668N/5 269,00 1 006680005

Nm	Kgfm	lbf.ft	Ø mm	L mm	LB mm	LS mm	g	📏
20÷100	2÷10	15÷75	16	376	269	32	670	1,0

668N/10 275,00 1 006680010

Nm	Kgfm	lbf.ft	Ø mm	L mm	LB mm	LS mm	g	📏
40÷200	4÷20	30÷150	16	450	352,6	32	795	2,0

668N/20 299,00 1 006680020

Nm	Kgfm	lbf.ft	Ø mm	L mm	LB mm	LS mm	g	📏
60÷300	6÷30	50÷220	16	588	475,9	32	1230	2,0

668N/30 339,00 1 006680030



668RG

barra dinamométrica, não graduada, para aperto à direita e à esquerda
precisão: $\pm 4\%$
(para utilização com artigos 680 - 682)



UNI EN ISO 6789

Nm	Kgfm	lbf.ft	Ø	L	g
8÷60	0,8÷6	6÷44	16	288	550

€ 222,00 1 006680206

Nm	Kgfm	lbf.ft	Ø	L	g
20÷100	2÷10	15÷80	16	315	600

€ 228,00 1 006680210

Nm	Kgfm	lbf.ft	Ø	L	g
40÷200	4÷20	30÷150	16	405	780

€ 243,00 1 006680220

Nm	Kgfm	lbf.ft	Ø	L	g
60÷300	6÷30	50÷220	16	645	1130

€ 271,00 1 006680230

668RGC

chave dinamométrica, não graduada, com roquete reversível, para aperto à direita, precisão de torque: $\pm 4\%$
(para utilização com referências 680 - 682)



UNI EN ISO 6789

Nm	Kgfm	lbf.in	D	A	L	g
12÷60	1,2÷6	5÷45	3/8	30	33	295

€ 202,00 1 006680406

Nm	Kgfm	lbf.in	D	A	L	g
20÷100	2÷10	15÷75	3/8	30	33	335

€ 211,00 1 006680410

Nm	Kgfm	lbf.in	D	A	L	g
20÷100	2÷10	15÷75	1/2	40	43	342

€ 211,00 1 006680411

Nm	Kgfm	lbf.in	D	A	L	g
40÷200	4÷20	30÷150	1/2	40	43	425

€ 216,00 1 006680420

669N

barras dinamométricas, encabadouro retangular fêmea, para operações à esquerda e à direita, precisão de torque: $\pm 3\%$



UNI EN ISO 6789

Nm	Kgfm	lbf.ft	□	L	LB	LS	g
5÷25	0,5÷2,5	4÷18	9x12	215	140	28,8	300

669N/2	€ 392,00	1	006690202
--------	----------	---	-----------

Nm	Kgfm	lbf.ft	□	L	LB	LS	g
10÷50	1÷5	7÷37	9x12	307	226,8	28,8	590

669N/5	€ 301,00	1	006690205
--------	----------	---	-----------

Nm	Kgfm	lbf.ft	□	L	LB	LS	g
20÷100	2÷10	15÷75	9x12	376	266,8	28,8	670

669N/10	€ 324,00	1	006690210
---------	----------	---	-----------

Nm	Kgfm	lbf.ft	□	L	LB	LS	g
40÷200	4÷20	30÷150	9x12	450	345,6	28,8	795

669N/20	€ 389,00	1	006690220
---------	----------	---	-----------

Nm	Kgfm	lbf.ft	□	L	LB	LS	g
40÷200	4÷20	30÷150	14x18	450	351	39,8	795

669N/20X	€ 410,00	1	006690221
----------	----------	---	-----------

Nm	Kgfm	lbf.ft	□	L	LB	LS	g
60÷300	6÷30	50÷220	14x18	588	468,5	39,8	1230

669N/30	€ 433,00	1	006690230
---------	----------	---	-----------

Nm	Kgfm	lbf.ft	□	L	LB	LS	g
80÷400	8÷40	60÷295	14x18	664	563	39,8	2100

669N/40	€ 499,00	1	006690240
---------	----------	---	-----------



671B/C5

Jogo com 1 barra dinamométrica ref. 604B/5, 1 roquete reversível, 8 chaves de caixa sextavadas e 4 ponteiros boca



671B/C5	€ 1.100,00	1	006710001
---------	------------	---	-----------

604B/5	1+5 Nm
611	1/4
641	5-6-7-8 mm
900	4-5-5,5-6-7-8-9-10 mm

270x120x45 mm - 1,3 kg

671B/C10

Jogo com 1 barra dinamométrica ref. 604B/10, 1 roquete reversível, 8 chaves de caixa sextavadas e 4 ponteiros boca



671B/C10	€ 1.100,00	1	006710002
----------	------------	---	-----------

604B/10	2+10 Nm
611	1/4
641	6-7-8-10 mm
900	4-5-5,5-6-7-8-9-10 mm

270x120x45 mm - 1,4 kg

671N/C10

barra dinamométrica 668N/10 e acessórios



671N/C10	€ 1.240,00	1	006710110
----------	------------	---	-----------

668N/10	100 Nm
612	3/8
617	3/8
642	10-13-14-17-19 mm
652	10-13-14-17-19 mm
910A	3/8 8-10-11-13-14-17-19 mm
910/21	125 mm
910/22	250 mm

400x180x45 mm - 4,3 kg

671N/C20

barra dinamométrica 668N/20
e acessórios



671N/C20 € 1.310,00 1 006710120

668N/20	200 Nm
614	■ 1/2
619	■ 1/2
642	10-13-14-17-19 mm
652	10-13-14-17-19 mm
○ 920A	□ 1/2 10-11-13-14-17-19-22 mm
920/20	75 mm
920/21	125 mm
920/22	255 mm

510x180x45 mm - 5,5 kg

671N/C30

barra dinamométrica 668N/30
e acessórios



671N/C30 € 1.250,00 1 006710130

668N/30	300 Nm
614	■ 1/2
619	■ 1/2
642	13-14-17-19 mm
652	13-14-17-19 mm
○ 920A	□ 1/2 13-14-17-19-22-24-27 mm
920/20	75 mm
920/21	125 mm
920/22	255 mm

620x180x45 mm - 5,8 kg

Beta

674/C

barras dinamométricas não graduadas,
encabadouro redondo Ø 22 mm,
para aperto à direita e à esquerda,
precisão: ± 4%,
em estojo



UNI EN ISO 6789

Nm	Kgfm	lbf.ft	Ø mm	L mm	LB mm	LS mm	kg	mm
100÷500	10÷50	80÷400	22	786	725	56	3,4	1,25

674/C50 € 910,00 1 006740005

Nm	Kgfm	lbf.ft	Ø mm	L mm	LB mm	LS mm	kg	mm
160÷800	16÷80	120÷600	22	997	915	56	4,5	2,0

674/C80 € 965,00 1 006740008

Nm	Kgfm	lbf.ft	Ø mm	L mm	LB mm	LS mm	kg	mm
200÷1000	20÷100	150÷750	22	997	915	56	4,5	2,5

674/C100 € 975,00 1 006740010

677

Chave dinamométrica com roquete reversível
para aperto à esquerda e à direita, precisão
±4% fornecidas em estojo



UNI EN ISO 6789

Nm	Kgfm	lbf.ft	D mm	A mm	L mm	kg	mm
120÷600	12÷60	100÷450	69	55	1059	6,0	10

677/600 € 1.020,00 1 006770006

Nm	Kgfm	lbf.ft	D mm	A mm	L mm	kg	mm
200÷800	20÷80	150÷600	69	55	1319	6,7	10

677/800 € 1.070,00 1 006770008

Nm	Kgfm	lbf.ft	D mm	A mm	L mm	kg	mm
300÷1000	30÷100	200÷750	69	55	1554	7,4	20

677/1000 € 1.140,00 1 006770010

677/C

chaves dinamométricas
com roquetes móveis,
para aperto à esquerda e à direita,
precisão de torque: ±4%
fornecidas em estojo



UNI EN ISO 6789

Nm	Kgfm	lbf.ft	D mm	A mm	L mm	kg	mm
120÷600	12÷60	100÷450	69	55	1059	6,0	10

677/C600 € 1.210,00 1 006770607

Nm	Kgfm	lbf.ft	D mm	A mm	L mm	kg	mm
200÷800	20÷80	150÷600	69	55	1319	6,7	10

677/C800 € 1.250,00 1 006770612

Nm	Kgfm	lbf.ft	D mm	A mm	L mm	kg	mm
300÷1000	30÷100	200÷750	69	55	1554	7,4	20

677/C1000 € 1.330,00 1 006770616

Nm	Kgfm	lbf.ft	D mm	A mm	L mm	kg	mm
700÷1500	70÷150	500÷1000	69	55	1869	9,6	25

677/C1500 € 1.700,00 1 006770621

677/CP2000

chave dinamométrica com embraiagem e
roquete simples
para aperto à direita e esquerda
precisão: ±4%
em estojo



UNI EN ISO 6789

Nm	Kgfm	lbf.ft	D mm	A mm	L mm	kg	mm
900÷2000	90÷200	700÷1500	69	63	1940	12,75	50

677/CP2000 € 3.110,00 1 006770721

Beta

Beta

WORKING TOOLS

Beta

678/C

chaves dinamométricas com roquetes móveis para aperto à esquerda e à direita precisão $\pm 4\%$ fornecidas em estojo

• Modelos 678/C100 e 678/C150 fornecidos com extensões.

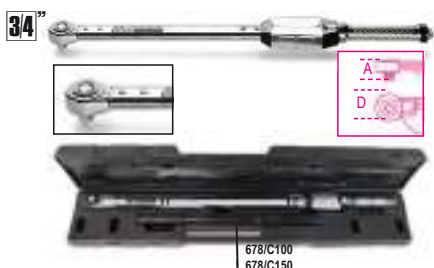

UNI EN ISO 6789

Nm	Kgfm	lbf.ft	D	A	L	kg	mm
130÷650	13÷65	100÷480	63	55	885	3,9	5,0

€	kg	mm
1.880,00	1	006780607

Nm	Kgfm	lbf.ft	D	A	L	kg	mm
300÷1000	30÷100	220÷750	75	60	1250	6,0	10

€	kg	mm
2.490,00	1	006780611

Nm	Kgfm	lbf.ft	D	A	L	kg	mm
500÷1500	50÷150	370÷1100	75	60	1570	8,5	10

€	kg	mm
2.710,00	1	006780615

677/CV - 678/CV

caixas metálicas para chaves dinamométricas modelos 677 e 678

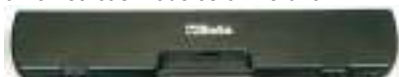

€	kg	mm
185,00	1	006770455

677/CV1	185,00	1	006770455
677/C600-677/C800-677/C1000	243,00	1	006770460

678/CV1	175,00	1	006780455
---------	--------	---	-----------

678/CV2	197,00	1	006780500
---------	--------	---	-----------

678/C100	324,00	1	006780415
----------	--------	---	-----------

677/C100-677/C150-678/C150	324,00	1	006780415
----------------------------	--------	---	-----------

680

medidor de torque digital eletrônico Dynatester 680 para testes de calibragem, operação à esquerda e à direita

- Precisão: $\pm 1\%$ do valor lido
- Monitor LCD a cores, 4 dígitos
- 3 unidades de medição: Nm - lbf.ft. - lbf.in



	Nm	kg	€	kg	mm
680/3	0,1÷3	1,4	3.190,00	1	006800000
680/30	1,5÷30	1,4	3.140,00	1	006800003
680/350	10÷350	2,6	3.160,00	1	006800035
680/2100	200÷2100	3,5	4.690,00	1	006800210

682

controlador de binário electrónico digital com transdutor Dynatester 682, para uso à direita e à esquerda

Alta precisão de leitura

Fornecido com porta série RS-232 para impressoras



CARACTERÍSTICAS TÉCNICAS

Precisão de leitura: $\pm 1\%$ do valor lido

Unidades de medida selecionáveis

Nm-dNm-cNm-Lbf.ft-Lbf.in-Ozf.in-Kgf.m-Kgf.cm-gf.cm

Alimentação: 90 a 264 V AC a 50/60 Hz

Dimensões: 235x185x185 mm

Tolerância de teste de acordo com a norma ISO 6789

Escala aceite para cada chave dinamométrica testada

Visor: Menu disponível em 11 línguas

Fornecido com todos os certificados necessários

Certificado de calibração com rastreabilidade UKAS

	Nm	kg	€	kg	mm
682/60	1,2÷60	5,9	6.550,00	1	006820006
682/400	8÷400	6,1	6.650,00	1	006820040
682/1500	30÷1500	6,4	6.850,00	1	006820150

CHAVES DE IMPACTO



Em comparação com as chaves de caixa, as chaves de impacto têm dimensões maiores, pelo que conseguem absorver apertos elevados como os que são produzidos pelas chaves de impacto e pelos multiplicadores de binário. O perfil sextavado proporciona maior durabilidade em utilização intensiva. Devem ser utilizadas com pinos e anilhas para impedir que se soltem do encabadouro.

Tal como acontece nos modelos clássicos para as versões standard e longas, está também disponível uma série longa e estreita destas chaves, para utilização em espaços a que não é possível aceder com os modelos standard. Contudo, considerando a sua força significativamente inferior, é recomendável uma utilização cuidadosa.



710

chaves de impacto série normal



UNI/ISO 2725 DIN 3129

mm	Ø mm	L mm	Ø1 mm	€	Unid.	Art.
7	12,5	28	19	9,60	3	007100007
8	13,8	28	19	9,60	3	007100008
9	15,0	28	19	9,60	3	007100009
10	16,3	28	19	9,60	3	007100010
11	17,5	30	19	9,60	3	007100011
12	19,0	30	19	9,60	3	007100012
13	20,0	30	22	10,10	3	007100013
14	21,3	30	22	10,10	3	007100014
16	23,8	30	22	10,20	3	007100016
17	25,0	30	22	10,20	3	007100017
18	26,3	30	22	10,50	3	007100018
19	27,5	30	22	10,50	3	007100019
21	30,0	32	22	11,60	3	007100021
22	32,0	32	22	12,90	3	007100022

710/C10

jogo com 10 chaves de impacto



710/C10 145,00 € 1 007100910

7-8-10-11-12-13
14-17-19-22 mm

130x55x40 mm - 800 g

710/16

adaptador quadra fêmea de 3/8" para quadra macho de 1/2"



710/16 26,00 € 3 007100810

L mm 32
Ø mm 22
3/8 1/2

710/20

extensões com quadras macho e fêmea de 3/8"



710/20 26,50 € 2 007100821

L mm 75
Ø mm 22

710/21

extensões com quadras macho e fêmea de 3/8"



710/21 29,00 € 2 007100823

L mm 125
Ø mm 22

710/22

extensão com quadras macho e fêmea de 3/8"



710/22 34,00 € 2 007100825

L mm 150
Ø mm 22

710/25

cardan com quadras macho e fêmea de 3/8"



710/25 53,50 € 2 007100830

L mm 58
Ø mm 24

710/OR... - 710/SP...

anéis em borracha e cavilhas de fixação para chaves de impacto e acessórios



	710 mm	710/16 L mm	€	Unid.	Art.
710/OR1	7-12		0,79	10	007100921
710/OR2	13-22	32	0,79	10	007100922
710/SP1	7-12		1,46	10	007100911
710/SP2	13-22	32	1,46	10	007100912

720

chaves de impacto série normal



UNI/ISO 2725 DIN 3129

mm	Ø mm	L mm	Ø1 mm	€	Unid.	Art.
8	15,0	38	25	11,50	5	007200008
9	16,0	38	25	11,50	5	007200009
10	17,0	38	25	11,70	5	007200010
11	18,5	38	25	11,70	5	007200011
12	20,0	38	25	11,70	5	007200012
13	21,0	38	25	11,70	5	007200013
14	22,5	38	25	11,70	5	007200014
15	23,0	38	30	13,10	5	007200015
16	25,0	38	30	13,10	5	007200016
17	26,0	38	30	13,10	5	007200017
18	27,5	38	30	13,10	5	007200018
19	28,5	38	30	13,10	5	007200019
20	30	38	30	14,40	5	007200020
21	31,0	38	30	14,40	5	007200021
22	32,5	38	30	14,70	5	007200022
23	34,0	38	30	16,00	5	007200023
24	35,0	38	30	16,00	5	007200024
27	38,5	45	30	18,60	3	007200027
29	41	47	30	20,30	3	007200029
30	42,0	50	30	20,30	3	007200030
32	44,0	50	30	23,30	3	007200032
36	50,0	50	30	33,50	3	007200036

720/C6

jogo com 6 chaves de impacto



720/C6 119,00 € 1 007200910

13-14-17-19-22-24 mm

195x80x55 mm - 1100 g

720/C12

jogo com 12 chaves de impacto



720/C12 216,00 € 1 007200912

10-11-12-13-14-17
19-22-24-27-30-32 mm

195x80x55 mm - 2000 g

720/C24

jogo de 24 chaves de caixa de impacto

12"



720/C24 € 460,00 1 007200904

- 720 10 - 12 - 13 - 14 - 15 - 16 - 17 - 18 - 19 - 21 - 22 - 24 - 27 - 30 - 32 mm
- 720L 13 - 17 - 19 - 21 - 22 - 24 mm
- 720LC 17 - 19 - 21 mm

420x185x60 mm - 6,2 kg

720MC

chaves de impacto, série standard, coloridas

12"



Ø	mm	L	mm	mm	mm	€		
10	17,0	38				12,10	3	007202010
11	18,5	38				12,10	3	007202011
12	20,0	38				12,10	3	007202012
13	21,0	38				12,10	3	007202013
14	22,5	38				12,10	3	007202014
15	23,0	38				13,70	3	007202015
16	25,0	38				13,70	3	007202016
17	26,0	38				13,70	3	007202017
18	27,5	38				13,70	3	007202018
19	28,5	38				13,70	3	007202019
21	31,0	38				15,20	2	007202021
22	32,5	38				15,20	2	007202022
24	35,0	38				16,60	2	007202024

720MC/C13

13 chaves de impacto, coloridas

12"



720MC/C13 € 220,00 1 007202913

- 10-11-12-13-14-15
- 16-17-18-19-21-22
- 24 mm

335x145x60 mm - 2,4 kg

720B

chaves de impacto bisextavadas

12"



UNI/ISO 2725 DIN 3129

Ø	mm	L	mm	Ø1	mm	€		
10	17	38	25			11,70	5	007201010
11	18	38	25			11,70	5	007201011
12	19	38	25			11,70	5	007201012
13	20	38	25			11,70	5	007201013
14	22	38	25			11,70	5	007201014
15	23	38	30			13,10	5	007201015
16	24	38	30			13,10	5	007201016
17	26	38	30			13,10	5	007201017
18	27	38	30			13,10	5	007201018
19	28	38	30			13,10	5	007201019
21	30	38	30			14,40	5	007201021
22	31,8	38	30			14,70	5	007201022
23	31,8	38	30			16,00	5	007201023
24	33,8	40	30			16,00	5	007201024
27	37,8	43	30			18,60	3	007201027
30	41,8	43	30			20,30	3	007201030
32	43,8	43	30			23,30	3	007201032
36	49,8	50	30			33,50	3	007201036

720B/C12

12 chaves de impacto bisextavadas

12"



UNI/ISO 2725 DIN 3129

720B/C12 € 216,00 1 007201912

- 10-11-12-13-14-17
- 19-22-24-27-30-32 mm

195x80x55 mm - 2000 g

720AS

chaves de impacto, série normal

12"



Ø	mm	L	mm	Ø1	mm	€		
3/8	17,0	38	25			18,90	2	007200210
7/16	18,2	38	25			18,90	2	007200211
1/2	20,7	38	25			18,90	2	007200213
9/16	22,0	38	25			18,90	2	007200214
5/8	24,5	38	30			20,30	2	007200216
11/16	25,7	38	30			20,30	2	007200217
3/4	28,2	38	30			20,30	2	007200219
13/16	30,7	38	30			21,50	2	007200221
7/8	32,0	38	30			21,50	2	007200222
15/16	34,5	38	30			22,90	2	007200224
1	35,7	38	30			24,70	2	007200225
1.1/16	38,2	40	30			27,50	1	007200227
1.1/8	40,7	42	30			30,50	1	007200229
1.1/4	44,5	42	30			34,00	1	007200232

720S

chaves de impacto, série compacta

12"



Ø	mm	L	mm	Ø1	mm	€		
13	20,0	28,0	23,8			7,40	3	007200113
15	23,0	28,0	23,8			7,40	3	007200115
17	25,8	28,0	25,8			8,00	3	007200117
19	27,8	28,0	27,8			8,70	3	007200119
22	31,8	28,0	30,0			9,50	3	007200122
24	33,8	28,0	30,0			10,40	3	007200124

12"



720S/SB6 € 63,00 1 007200906

- 13-15-17-19-22-24 mm

720L

chaves de impacto série longa

12"



UNI/ISO 2725

Ø	mm	L	mm	Ø1	mm	€		
10	17,0	80	25			20,00	2	007200310
11	18,5	80	25			20,00	2	007200311
12	20,0	80	25			20,00	2	007200312
13	21,0	80	25			20,00	2	007200313
14	22,5	80	25			20,00	2	007200314
15	23,0	80	30			22,70	2	007200315
16	25,0	80	30			22,70	2	007200316
17	26,0	80	30			22,70	2	007200317
18	27,5	80	30			24,00	2	007200318
19	28,5	80	30			24,00	2	007200319
21	31,0	80	30			25,50	2	007200321
22	32,5	80	30			25,50	2	007200322
24	35,0	80	30			26,50	2	007200324
27	38,5	80	30			33,50	2	007200327
30	42,0	80	30			40,50	2	007200330
32	44,0	80	30			40,50	2	007200332
36	50,0	80	30			52,00	2	007200336

720L/S3

jogo de 3 chaves de impacto 720L

12"



720L/S3 € 72,00 1 007200355

720LS

chaves de impacto,
série longa



Ø mm	Ø mm	L mm	Ø1 mm	€	U	L
10	15,5	78	24	21,50	2	007200360
11	16,7	78	24	21,50	2	007200361
12	18,0	78	24	21,50	2	007200362
13	19,2	78	24	21,50	2	007200363
14	20,5	78	24	21,50	2	007200364
15	21,7	78	24	22,20	2	007200365
16	23,0	78	24	22,20	2	007200366
17	24,2	78	29	24,70	2	007200367
18	25,5	78	29	26,50	2	007200368
19	26,7	78	29	26,50	2	007200369
21	29,2	78	29	28,00	2	007200371
22	30,5	78	29	28,00	2	007200372
24	33,0	78	29	28,50	2	007200374
27	36,7	78	29	35,00	2	007200377
30	40,5	78	29	44,00	2	007200380
32	43,0	78	29	46,00	2	007200382
36	48,0	78	29	69,00	2	007200386

720LC

chaves de impacto para porcas de roda,
com inserts coloridos em polímero



Ø mm	Ø mm	€	U	L
17	26,5	14,40	2	007200637
19	28,5	14,40	2	007200639
21	30,3	15,00	2	007200641
22	32,4	15,60	2	007200642
24	34,6	16,90	2	007200644



720LC/C3	€	U	L
17-19-21 mm	43,50	1	007200653

148x132x44 mm - 860 g



720LC/S5	€	U	L
17-19-21-22-24 mm	76,50	1	007200645

12"



720LC/PM5	€	U	L
17-19-21-22-24 mm	129,00	1	007200646

PM 1/2-Q5

calha magnética para chaves de caixa



PM 1/2-Q5	€	U	L
	52,00	1	088880233

720IC

inserts sobresselentes coloridos em polímero
para chaves de impacto 720LC-720LCL



720IC	Ø mm	€	U	L
17	17	5,80	1	007200687
19	19	5,80	1	007200689
21	21	5,80	1	007200691
22	22	5,80	1	007200692
24	24	5,80	1	007200694



720LCL

chaves de impacto para porcas de roda,
com inserts coloridos em polímero,
série longa



Ø mm	Ø mm	€	U	L
17	26,5	23,80	1	007200737
19	28,5	23,80	1	007200739
21	30,3	23,80	1	007200741



720LCL/C3	€	U	L
17-19-21 mm	91,50	1	007200753

210x50x150 mm - 1,65 kg

720MRC

chave de impacto
com insert polimérico parafusos de rodas
Mercedes



Ø mm	Ø mm	L mm	€	U	L
17	27	85	23,40	1	007200631

720FRD

chave de impacto para porcas de rodas Ford
com tampas em alumínio danificadas

necessária quando as tampas das porcas foram danificadas
por chaves de impacto



Ø mm	L mm	€	U	L
18,5+19,5	63	22,20	1	007200633

720RNG

chave de impacto para porcas de rodas Jeep
Renegade com tampas de alumínio
danificadas

necessário quando as tampas das porcas estão danificadas



Ø mm	L mm	€	U	L
16,5+17,5	63	22,20	1	007200634

720TC

barras de torção de impacto, coloridas,
para porcas de rodas de automóveis,
com quadras macho e fêmea 1/2



Nm	L mm	€	U	L
90	200	25,00	1	007200769
100	200	25,00	1	007200770
110	200	25,00	1	007200771
120	200	25,00	1	007200772
135	200	25,00	1	007200773

12"



720TC/S5 € 126,00 1 007200779
 90-100-110-120-135 Nm
 ≡ 260x50x175 mm - 1,35 kg

720FTX

chaves de caixa para parafusos com perfil Torx®



12"



	Ø mm	L mm	Ø1 mm	€		
E10	14,0	38	25	18,70	2	007200410
E12	15,9	38	25	18,70	2	007200412
E14	17,7	38	25	18,70	2	007200414
E16	20,0	38	25	18,70	2	007200416
E18	22,0	38	25	18,70	2	007200418
E20	25,0	40	25	19,90	2	007200420
E24	30,0	40	30	19,90	2	007200424



12"



720FTX/SB6 € 125,00 1 007200450
 E10-E12-E14
 E16-E18-E20

720TX

chaves de impacto para parafusos Torx®



12"



	Ø mm	L mm	L1 mm	€		
T30	25	78	54	16,40	3	007200460
T40	25	78	54	16,40	3	007200470
T45	25	78	54	16,70	3	007200472
T50	25	78	54	16,70	3	007200474
T55	25	78	54	18,90	3	007200476
T60	25	78	54	20,30	3	007200478

720TX/C6

jogo de 6 chaves de impacto para parafusos Torx® em caixa metálica



12"



720TX/C6 € 138,00 1 007200483
 T30-T40-T45
 T50-T55-T60

≡ 275x120x65 mm - 5700 g

720ME

chaves de impacto sextavadas



12"



mm	Ø mm	L mm	L1 mm	€		
5	25	78	54	15,70	3	007200505
6	25	78	54	15,70	3	007200506
8	25	78	54	15,70	3	007200508
10	25	78	54	15,70	3	007200510
12	25	78	54	15,70	3	007200512
14	25	78	54	17,60	3	007200514
17	25	78	54	17,60	3	007200517
19	25	78	54	17,60	3	007200519

720ME/C8

jogo de 8 chaves de impacto sextavadas



12"



720ME/C8 € 169,00 1 007200525
 5-6-8-10-12
 14-17-19 mm

≡ 270x120x45 mm - 1710 g

9899 720ME/C8 € 15,20 1 098990130
 Tabuleiro maleável, vazio

720XZN

chaves de impacto para parafusos XZN®



12"



	Ø mm	L mm	L1 mm	€		
M4	25	77	53	17,80	3	007201504
M5	25	77	53	17,80	3	007201505
M6	25	77	53	17,80	3	007201506
M8	25	77	53	17,80	3	007201508
M10	25	77	53	18,30	3	007201510
M12	25	77	53	18,70	3	007201512
M14	25	77	53	18,70	3	007201514
M16	25	77	53	19,10	3	007201516
M18	25	77	53	20,10	3	007201518

720XZN/C6

6 chaves de impacto para parafusos de perfil XZN®



12"



720XZN/C6 € 145,00 1 007201530
 M8-M10-M12-M14
 M16-M18

≡ 275x120x65 mm - 5700 g

720/SN

chaves de impacto, série articulada



12"



	Ø mm	L mm	Ø1 mm	€		
17	25,7	69,6	30	82,00	2	007200087
19	28,2	73,6	30	82,00	2	007200089
24	34,5	75,6	30	92,00	2	007200094

720/15

adaptador quadra fêmea de 1/2" para quadra macho de 3/8"

12"



L mm	Ø mm	□	■	€		
37,5	25	1/2	3/8	13,10	3	007200810



Aplique sempre uma força de aperto regular e progressiva, a fim de evitar a ruptura do material e de se proteger de um possível acidente

720/16

adaptador quadra fêmea de 1/2" para quadra macho de 3/4"

12"



L mm	Ø mm	□	■	€		
44	30	1/2	3/4	22,60	3	007200814

720/20

extensões com quadras macho e fêmea de 1/2"



L mm	Ø mm	€	3	007200818
75	25	23,30		

720/21

extensões com quadras macho e fêmea de 1/2"



L mm	Ø mm	€	3	007200822
125	25	25,00		

720/22

extensão com quadras macho e fêmea de 1/2"



L mm	Ø mm	€	3	007200824
250	25	29,50		

720/25

cardan com quadras macho e fêmea de 1/2"



L mm	Ø mm	€	2	007200831
64	28	43,00		

720/OR... - 720/SP...

anéis em borracha e cavilhas de fixação para chaves de impacto e acessórios



	720 mm	720TX mm	€	10	
720/OR1	10÷14	T30÷T60	1,49		007200923
720/OR2	15÷36		1,49		007200924
720/SP1	10÷14	T30÷T60	2,20		007200913
720/SP2	15÷36		2,20		007200914

727PI/16 1/2

chaves porta-pontas de impacto para artigos 727/ES16, 727/ES16TX e 727/ES16XZN

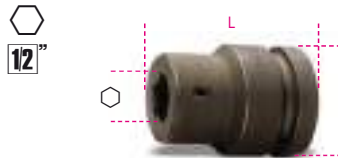

Ø mm	L mm	Ø mm	□	€	2	007270015
28	42	16	1/2	38,50		

727PI/16

chave porta-pontas de impacto 16 mm para os artigos 727/ES16 e 727/ES16TX



Ø mm	L mm	Ø mm	□	€	2	007270016
44	52	16	3/4	51,00		

727/ES16

pontas de impacto sextavados 16 mm



mm	Ø mm	L mm	€	2	
10	16	40	17,20		007270110
12	16	40	17,20		007270112
13	16	40	17,20		007270113
14	16	40	17,20		007270114
16	16	40	18,50		007270116
17	16	40	18,50		007270117
18	16	40	19,20		007270118
19	16	40	19,20		007270119
22	16	40	22,20		007270122

727/ES16TX

pontas de impacto 16 mm para parafusos Torx®



Ø	mm	L mm	€	2	
T55	16	50	26,00		007270355
T60	16	50	26,00		007270360
T70	16	50	26,00		007270370

727/ES16XZN

bits de impacto para parafusos cabeça XZN®, encabadouro 16 mm



Ø	mm	L mm	€	2	
M6	16	60	31,00		007270606
M8	16	60	31,00		007270608
M10	16	60	31,00		007270610
M12	16	60	31,00		007270612
M14	16	60	31,00		007270614
M16	16	60	31,00		007270616
M18	16	60	43,00		007270618

Beta

Beta

727PI/22

chave porta-pontas de impacto 22 mm
para os artigos 727/ES22 e 727/ES22TX



Ø mm	L mm	Ø mm	€	🔧	📄
54	70	22	78,50	2	007270022

727/ES22

pontas de impacto sextavados 22 mm



mm	● mm	L mm	€	🔧	📄
19	22	50	22,20	2	007270219
22	22	50	22,20	2	007270222
24	22	50	24,50	2	007270224
27	22	50	27,50	2	007270227
30	22	50	32,50	2	007270230
32	22	50	35,50	2	007270232

727/ES22TX

pontas de impacto 22 mm
para parafusos Torx®



⊙	● mm	L mm	€	🔧	📄
T80	22	60	36,00	2	007270480
T90	22	60	36,00	2	007270490
T100	22	60	36,00	2	007270500

727/C16

jogo com 12 pontas de impacto
e 4 acessórios



727/C16	€	🔧	📄
	493,00	1	007270900

727PI/16
727/ES16 14-17-19 mm
727/ES16TX T55-T60-T70
727PI/22
727/ES22 22-24-27 mm
727/ES22TX T80-T90-T100
96BPC 3-4 mm

≡ 335x145x60 mm - 5,3 kg

727PI/32

chave porta-pontas de impacto 32 mm
para os artigos 727/ES22 e 727/ES22TX



Ø mm	L mm	Ø mm	€	🔧	📄
86	66	32	196,00	1	007270032

727/ES32

pontas de impacto sextavados 32 mm



mm	● mm	L mm	€	🔧	📄
19	32	44	50,50	2	007270519
22	32	44	50,50	2	007270522
24	32	44	50,50	2	007270524
27	32	44	50,50	2	007270527
30	32	44	50,50	2	007270530
32	32	44	50,50	2	007270532
36	32	44	56,50	2	007270536

728

chaves de impacto série normal



UNI/ISO 2725 DIN 3129

⊙ mm	Ø mm	L mm	Ø1 mm	€	🔧	📄
17	30,0	51	44	29,00	2	007280017
18	31,0	51	44	29,00	2	007280018
19	32,5	51	44	29,00	2	007280019
21	35,0	51	44	29,00	2	007280021
22	36,0	51	44	29,00	2	007280022
23	37,5	51	44	29,50	2	007280023
24	38,5	51	44	29,50	2	007280024
27	42,5	53	44	29,50	2	007280027
28	44,0	53	44	30,00	2	007280028
30	46,0	53	44	31,00	2	007280030
32	48,5	57	44	32,50	2	007280032
33	50,0	57	44	35,00	2	007280033
34	51,0	57	44	35,00	2	007280034
35	52,5	57	44	36,00	2	007280035
36	53,5	57	44	37,00	2	007280036
38	56,0	57	44	41,50	1	007280038
40	58,5	58	44	44,00	1	007280040
41	60,0	58	44	44,50	1	007280041
44	64,0	62	44	48,50	1	007280044
45	65,0	62	44	52,50	1	007280045
46	66,0	62	44	53,00	1	007280046
50	71,0	68	54	62,50	1	007280050
55	77,5	71	54	69,50	1	007280055
60	83,0	73	54	79,50	1	007280060
65	88,0	78	54	88,00	1	007280065

Beta
Quality Tools

728/C10

jogo com 10 chaves de impacto



728/C10	€	🔧	📄
	387,00	1	007280910

17-19-22-24-27-30
32-36-41-46 mm

≡ 275x120x65 mm - 5,7 kg

728B

chaves de impacto bisextavadas



UNI/ISO 2725 DIN 3129

⊙ mm	Ø mm	L mm	Ø1 mm	€	🔧	📄
17	28,5	50	38	29,00	2	007280117
19	30	52	38	29,00	2	007280119
21	32	52	38	29,00	2	007280121
22	34	52	38	29,00	2	007280122
23	35	52	38	29,50	2	007280123
24	36	52	38	29,50	2	007280124
27	40	52	40	29,50	2	007280127
29	42	52	42	30,50	2	007280129
30	44	52	44	31,00	2	007280130
32	48	52	44	32,50	2	007280132
33	50	56	44	35,00	2	007280133
34	51	56	44	35,00	2	007280134
35	52	56	44	36,00	2	007280135
36	53,5	56	44	37,00	2	007280136
38	56	56	44	41,50	1	007280138
41	60	58	44	44,50	1	007280141
46	67	63	44	53,00	1	007280146

728B/C10

10 chaves de impacto bisextavadas



728B/C10	€	🔧	📄
	387,00	1	007280930

17-19-22-24-27
30-32-36-41-46 mm

≡ 275x120x65 mm - 5,7 kg

728AS

chaves de impacto,
série normal



"	Ø mm	L mm	Ø1 mm	€		
3/4	32,0	51	41	29,00	1	007280219
13/16	35,0	51	41	29,50	1	007280221
7/8	36,0	51	41	29,50	1	007280222
15/16	38,5	51	41	29,50	1	007280224
1	40,0	53	41	30,00	1	007280225
1.1/16	42,5	53	44	32,00	1	007280227
1.1/8	44,0	53	44	32,50	1	007280230
1.1/4	48,5	57	44	33,50	1	007280232
1.5/16	50,0	57	44	35,00	1	007280233
1.7/16	53,5	57	44	37,00	1	007280236
1.1/2	56,0	57	44	41,00	1	007280238
1.5/8	60,0	58	44	44,50	1	007280241

728FTX

chave de impacto para parafusos de perfil
Torx®



"	Ø mm	L mm	Ø1 mm	€		
E20	28,5	50	44	38,50	2	007280420
E22	30,0	50	44	38,50	2	007280422
E24	32,5	50	44	38,50	2	007280424

728ME

chaves de impacto
para parafusos sextavados



mm	Ø mm	L mm	L1 mm	€		
12	44	100	67	34,00	3	007280712
14	44	100	67	37,50	3	007280714
17	44	100	67	37,50	3	007280717
19	44	100	67	37,50	3	007280719
22	44	100	67	44,00	3	007280722
24	44	100	67	44,00	3	007280724

728ME/C6

6 chaves de impacto para parafusos
sextavados



728ME/C6	€		
12-14-17-19-22-24 mm	278,00	1	007280906

335x145x60 mm - 4,0 kg

728L

chaves de impacto,
série longa



"	Ø mm	L mm	Ø1 mm	€		
17	30	90	44	46,00	2	007280317
19	32,5	90	44	46,00	2	007280319
21	35,0	90	44	46,00	2	007280321
22	36,0	90	44	46,00	2	007280322
24	38,5	90	44	46,00	2	007280324
26	41,0	90	44	46,00	2	007280326
27	42,5	90	44	46,00	2	007280327
30	46,0	90	44	47,50	2	007280330
32	48,5	90	44	50,50	2	007280332
33	50,0	90	44	53,50	1	007280333
34	51,0	90	44	57,00	1	007280334
36	53,5	90	44	59,00	1	007280336
38	56,0	90	44	69,00	1	007280338
41	60,0	90	44	70,50	1	007280341
44	64,0	90	44	81,00	1	007280344
46	66,0	90	44	81,00	1	007280346
50	71,0	90	44	96,50	1	007280350
55	77,5	100	54	127,00	1	007280355



728LS3	€		
30-32-36 mm	157,00	1	007280393

728LS

chaves de impacto série longa
com paredes finas



"	Ø mm	L mm	Ø1 mm	€		
17	28,0	100	43	52,00	2	007280517
19	30,5	100	43	52,00	2	007280519
22	34,3	100	43	53,00	2	007280522
24	36,8	100	43	53,00	2	007280524
27	40,5	100	43	53,00	2	007280527
30	44,3	100	43	53,00	2	007280530
32	46,8	100	43	57,00	2	007280532
33	48,0	100	43	58,50	2	007280533
36	51,8	100	43	68,50	1	007280536

728LQ

chaves de impacto, série longa

(para porcas de rodas ISUZU)



"	L mm	Ø mm	Ø1 mm	€		
19	90	35	43,5	46,50	1	007280619
21	90	42	43,5	46,50	1	007280621

728/15

redução quadra fêmea de 3/4"
para quadra macho de 1/2"



L mm	Ø mm	□	■	€		
58	38	3/4	1/2	36,00	2	007280810



Aplique sempre uma força de aperto regular e progressiva, a fim de evitar a ruptura do material e de se proteger de um possível acidente

728/16

adaptador quadra fêmea de 3/4"
para quadra macho de 1"



L mm	Ø mm	□	■	€		
62	44	3/4	1	43,50	2	007280813

728/21

extensões com quadras macho
e fêmea de 3/4"



L mm	Ø mm	€		
175	44	53,50	2	007280815

728/22

extensões com quadras macho
e fêmea de 3/4"



L mm	Ø mm	€		
250	44	62,00	2	007280825

728/22L

extensões com quadras macho e fêmea de 3/4"



L mm	Ø mm	€		
330	44	79,50	1	007280826

728/25

cardan com quadras macho e fêmea de 3/4"



L mm	Ø mm	€	1	007280830
107,5	44	105,00		

728/OR - 728/SP

anéis em borracha e cavilhas de fixação para chaves de impacto e acessórios



	728	728FTX	€	1	007280925
	mm	mm			
728/OR-15	728/15		2,19	5	007280925
728/OR	17+46	E20+E24	2,33	10	007280926
728/SP	17+46	E20+E24	3,05	10	007280916

729

chaves de impacto série normal



UNI/ISO 2725 DIN 3129

Ø mm	Ø mm	L mm	Ø1 mm	€	1	007290024
24	41,5	58	54	46,50	1	007290024
27	45,0	60	54	46,50	1	007290027
30	49,0	62	54	46,50	1	007290030
32	51,5	63	54	47,50	1	007290032
33	52,5	63	54	47,50	1	007290033
34	54,0	63	54	47,50	1	007290034
36	56,5	66	54	47,50	1	007290036
38	59,0	66	54	57,50	1	007290038
41	62,5	68	54	58,50	1	007290041
46	69,0	72	54	65,50	1	007290046
50	74,0	76	54	81,00	1	007290050
55	80,0	84	54	86,50	1	007290055
60	86,5	88	54	105,00	1	007290060
65	92,5	92	54	120,00	1	007290065
70	99,0	96	54	154,00	1	007290070
75	105,0	102	63	179,00	1	007290075
80	111,5	102	63	193,00	1	007290080

729L

chaves de impacto série longa



Ø mm	Ø mm	L mm	Ø1 mm	€	1	007290324
24	41,5	108	54	82,50	1	007290324
27	45,0	108	54	82,50	1	007290327
30	49,0	108	54	82,50	1	007290330
32	51,5	108	54	82,50	1	007290332
33	52,2	108	54	83,50	1	007290333
34	54,0	108	54	83,50	1	007290334
36	56,5	108	54	83,50	1	007290336
41	62,5	108	54	99,50	1	007290341
46	69,0	108	54	115,00	1	007290346
50	74,0	108	54	129,00	1	007290350

Ø mm	Ø mm	L mm	Ø1 mm	€	1	007290355
55	80,0	108	54	155,00	1	007290355
60	86,5	108	54	167,00	1	007290360
65	92,5	108	54	202,00	1	007290365
70	99,0	108	54	229,00	1	007290370
75	105,0	108	63	259,00	1	007290375
80	111,5	108	63	272,00	1	007290380

729LS

chaves de impacto série longa com paredes finas



Ø mm	Ø mm	L mm	Ø1 mm	€	1	007290522
22	36,0	108	53	82,50	1	007290522
24	38,5	108	53	82,50	1	007290524
27	46,0	108	53	82,50	1	007290527
30	50,0	108	53	87,50	1	007290530
32	50,0	108	53	87,50	1	007290532
33	52,0	108	53	87,50	1	007290533
36	56,0	108	53	87,50	1	007290536

729T

barra de torção de impacto para cubos de roda



Ø mm	Nm	L mm	€	1	007290724
24	350	300	161,00	1	007290724
27	450	300	161,00	1	007290757
30	500	300	162,00	1	007290730
32	450	300	165,00	1	007290732
32	600	300	165,00	1	007290762
33	600	300	173,00	1	007290763
36	600	300	184,00	1	007290736

729/15

redução quadra fêmea de 1" para quadra macho de 3/4"



L mm	Ø mm	□	■	€	1	007290810
66,5	54	1	3/4	55,50		



Aplique sempre uma força de aperto regular e progressiva, a fim de evitar a ruptura do material e de se proteger de um possível acidente

729/16

redução quadra fêmea de 1" para quadra macho de 1.1/2"



L mm	Ø mm	□	■	€	1	007290813
88	54,0	1	1.1/2	90,50		

729/21

extensões com quadras macho e fêmea de 1"



L mm	Ø mm	€	1	007290815
175	54	84,50		

729/21L

extensões, com quadras macho e fêmea de 1"



L mm	Ø mm	€	1	007290826
250	54	104,00		

729/22

extensões com quadras macho e fêmea de 1"



L mm	Ø mm	€	1	007290825
330	54	121,00		

729/25

cardan com quadras macho e fêmea de 1"



L mm	Ø mm	€	1	007290830
130	54	175,00		

729/OR... - 729/SP...

anéis em borracha e cavilhas de fixação para chaves de impacto e acessórios



	728	729-730	€	1	007290927
	mm	mm			
729/OR1	50+60	24+70	2,38	5	007290927
729/OR2		75+125	3,70	5	007290928
729/SP1	50+60	24+70	2,24	5	007290917
729/SP2		75+125	3,70	5	007290918

730

chaves de impacto série normal



UNI/ISO 2725 DIN 3129

Ø	Ø	L	Ø1	€		
mm	mm	mm	mm			
50	81	87	84	241,00	1	007300050
55	88	90	86	247,00	1	007300055
60	94	95	86	273,00	1	007300060
65	100	100	86	299,00	1	007300065
70	106	105	86	354,00	1	007300070
75	113	110	86	410,00	1	007300075
80	119	115	86	469,00	1	007300080
85	125	120	86	520,00	1	007300085
90	132	125	86	595,00	1	007300090
95	138	125	96	690,00	1	007300095
100	144	130	96	800,00	1	007300100
105	150	135	96	895,00	1	007300105
110	157	140	96	970,00	1	007300110
115	163	140	96	1.050,00	1	007300115
120	169	145	96	1.170,00	1	007300120
125	175	145	96	1.220,00	1	007300125

730L

chaves de impacto sextavadas, série longa



Ø	Ø	L	Ø1	€		
mm	mm	mm	mm			
50	81	135	86	385,00	1	007300350
55	87	140	86	395,00	1	007300355
60	93	150	86	438,00	1	007300360
65	97	150	86	479,00	1	007300365
70	105	160	86	570,00	1	007300370
75	110	170	86	660,00	1	007300375
80	116	170	86	755,00	1	007300380
85	125	170	86	835,00	1	007300385
90	130	170	86	950,00	1	007300390
95	137	180	95	1.110,00	1	007300395
100	144	190	95	1.280,00	1	007300400
105	150	190	95	1.430,00	1	007300405
110	156	200	95	1.550,00	1	007300410
115	160	200	95	1.670,00	1	007300415
120	168	210	95	1.870,00	1	007300420

730/15

adaptadores



L	Ø	€		
mm	mm			
105	84,0	189,00	1	007300810



Aplique sempre uma força de aperto regular e progressiva, a fim de evitar a ruptura do material e de se proteger de um possível acidente

730/21

extensões, com quadras macho e fêmea de 1.1/2"

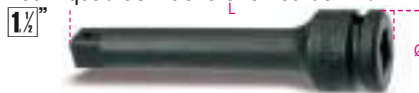

L	Ø	€		
mm	mm			
250	86	690,00	1	007300822

730/25

cardan, com quadras macho e fêmea de 1.1/2"



L	Ø	€		
mm	mm			
150	86	725,00	1	007300830

733/15

adaptadores



L	Ø	□	■	€		
mm	mm					
156	127	2.1/2	1.1/2	665,00	1	007330810



BITS

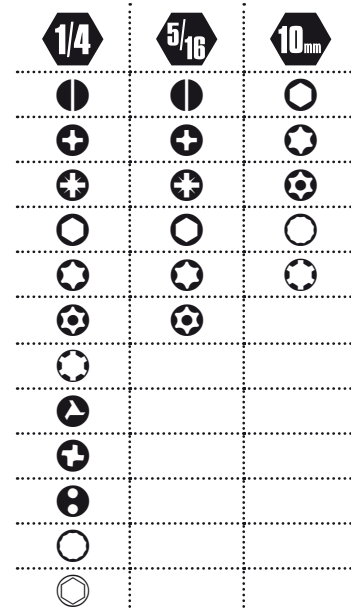

ISO 1173-C 6,3



assento de mola de retenção

ISO 1173-E 6,3



ranhura de esfera de retenção

851

porta pontas magnético com punho



L1	L	€		
mm	mm			
45	165	17,60	2	008510165
125	245	20,40	2	008510245

851SR

porta-pontas de desengate rápido com punho



L	L1	€		
mm	mm			
230	110	24,30	2	008510001

852

porta-bits, com cabo articulado em T

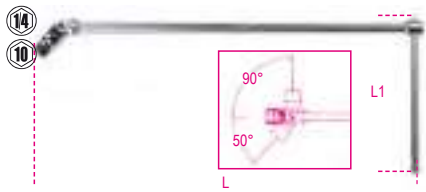

	L mm	L1 mm	€		
1/4"	400	160	53,00	2	008520006
10 mm	400	160	53,00	2	008520010

855P

punho porta-pontas com roquete reversível, articulado, com 7 bits integrados

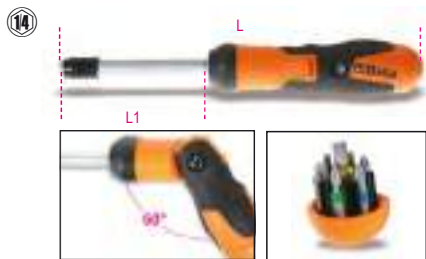

L mm	L1 mm	€		
240	100	80,00	1	008550010

	+	860PH	PH1 - PH2
	+	860PZ	PZ1 - PZ2
	+	860LP	LP 0,8x5,5 mm
	○	860PE	4 - 5 mm

860LP

bits para parafusos ranhurados, coloridos



ISO 2351-1
ISO 1173 C 6,3

SxA mm	L mm	€		
0,5x3	25	2,08	5	008600005
0,6x4,5	25	2,08	5	008600010
0,8x5,5	25	2,08	5	008600015
1x5,5	25	2,08	5	008600020
1,2x6,5	25	2,08	5	008600025

860PH

bits para parafusos Phillips®, coloridos



ISO 2351-2
ISO 1173 C 6,3

PH	L mm	€		
0	25	2,08	5	008600220
1	25	2,08	5	008600225
2	25	2,08	5	008600230
3	25	2,08	5	008600245
4	25	3,00	5	008600250

860PZ

bits para parafusos Pozidriv® - Supadriv®, coloridos



ISO 2351-2
ISO 1173 C 6,3

PZ	L mm	€		
1	25	2,08	5	008600320
2	25	2,08	5	008600325
3	25	2,08	5	008600330
4	25	3,00	5	008600335

860PE

bits sextavados para aparafusadoras eléctricas, coloridos



ISO 2351-3
ISO 1173 C 6,3

mm	L mm	€		
2	25	2,22	5	008600101
2,5	25	2,22	5	008600102
3	25	2,22	5	008600103
4	25	2,22	5	008600104
5	25	2,22	5	008600105
6	25	2,22	5	008600106
8	25	2,79	5	008600108
10	25	2,79	5	008600110

860TX

bits para parafusos Torx®, coloridos



ISO 1173 C 6,3

	L mm	€		
T6	25	2,79	5	008600704
T7	25	2,79	5	008600705
T8	25	2,79	5	008600710
T9	25	2,79	5	008600715
T10	25	2,22	5	008600720
T15	25	2,22	5	008600725
T20	25	2,22	5	008600730
T25	25	2,22	5	008600735
T27	25	2,22	5	008600740
T30	25	2,22	5	008600745
T40	25	2,22	5	008600750

860RTX

bits para parafusos invioláveis Torx®, coloridos



ISO 1173 C 6,3

	L mm	€		
T9	25	3,00	5	008600550
T10	25	3,00	5	008600555
T15	25	3,00	5	008600560
T20	25	3,00	5	008600565
T25	25	3,00	5	008600570
T27	25	3,00	5	008600575
T30	25	3,00	5	008600580
T40	25	3,00	5	008600585

860/55

chave de bits reversível



L mm	Ø mm	€		
100	1/4	35,50	3	008600870

860/58

roquete com punho rotativo

- O bit encaixa em ambos os lados, para aparafusar ou desaparafusar
- Punho bi-material



L mm	Ø mm	A mm	€				
860/58	126	1/4"	27	15	82,00	1	008600884

860/C27

jogo de 25 bits, 1 conector e 1 roquete reversível em estojo de plástico



€		
860/C27	97,00	1 008600880

	860/55	100 mm
	860LP	0,5x3-1,0x5,5-1,2x6,5 mm
	860PH	PH1-PH2(x2)-PH3
	860PZ	PZ1-PZ2(x2)-PZ3
	860PE	2-2,5-3-4-5-6 mm
	860TX	T6-T8-T10-T15-T20-T25-T30-T40
	892/0	● 1/4 ■ 1/4

860PHZ/A10

jogo de 10 pontas com porta pontas magnético em caixa plástica



€		
860PHZ/A10	40,50	1 008600910

	860PH	PH1	n.
		PH2	1
		PH3	3
	860PZ	PZ1	1
		PZ2	3
		PZ3	1
	882M1	○ 1/4 ■ 1/4	

860PE/A10

jogo de 10 pontas com porta pontas magnético em caixa plástica



860PE/A10 € 42,00 1 008600920

	860PE	2 - 2,5 mm	n.
	882M1	3 - 4 - 5 - 6 mm	1
		○ 1/4 ● 1/8	2

860TX/A10

jogo de 10 pontas com porta pontas magnético em caixa plástica



860TX/A10 € 43,00 1 008600970

	860TX	T7 - T8 - T9 - T10 - T15 - T20	n.
	882M1	T25 - T27 - T30 - T40	1
		○ 1/4 ● 1/8	

860MIX/A10

jogo de 10 pontas com porta pontas magnético em caixa plástica



860MIX/A10 € 40,50 1 008600900

	860LP	0,5x3 - 1x5,5 - 1,2x6,5 mm	n.
	860PH	PH1	1
		PH2	2
		PH3	1
	860PZ	PZ1 - PZ2 - PZ3	1
	882M1	○ 1/4 ● 1/8	

860MIX/A31

jogo de 30 pontas com porta pontas magnético de desengate rápido em caixa plástica



860MIX/A31 € 95,50 1 008600902

	860LP	0,5x3 - 0,6x4,5 - 0,8x5,5 1,0x5,5 - 1,2x6,5 mm
	860PE	2 - 2,5 - 3 - 4 - 5 - 6 8 - 10 mm
	860PH	PH0 - PH1 - PH2 - PH3 - PH4
	860PZ	PZ1 - PZ2 - PZ3 - PZ4
	860RTX	T9 - T10 - T15 - T20 T25 - T27 - T30 - T40
	882MSR 50	○ 1/4 ● 1/8

860/C38P

1 punho porta-pontas com roquete reversível, 27 bits, 8 chaves de caixa sextavadas e 2 acessórios em estojo de metal com tabuleiro maleável

porta-pontas com roquete reversível
tampa porta-bits
barra de extensão amovível de montagem rápida



860/C38P € 210,00 1 008600878

	860LP	0,6x4,5 - 0,8x5,5 - 1,0x5,5 - 1,2x6,5 mm
	860PE	2-2,5-3-4(x2)-5(x2) mm
	860PH	PH1(x2)-PH2(x2)-PH3
	860PZ	PZ1(x2)-PZ2(x2)-PZ3
	860TX	T10-T15-T20-T25-T30-T40
	900	5-5,5-6-7-8-9-10-13 mm
	892/0	● 1/4 ■ 1/4
	892/3	● 1/4 ■ 1/4
	855P	240 mm

270x120x45 mm

861LP

pontas para parafusos de fenda



ISO 2351-1

ISO 1173 C 6,3

SxA mm	L mm	€	U	U
0,5x3	25	1,35	10	008610005
0,6x4	25	1,35	10	008610007
0,6x4,5	25	1,35	10	008610010
0,8x5,5	25	1,35	10	008610015
1x5,5	25	1,35	10	008610020
1,2x6,5	25	1,35	10	008610025
1,2x8	25	2,58	10	008610028
1,6x8	25	2,58	10	008610030

861PH

pontas para parafusos de perfil Phillips(R)



ISO 2351-2

ISO 1173 C 6,3

PH	L mm	€	U	U
0	25	1,33	10	008610200
1	25	1,33	10	008610205
2	25	1,33	10	008610210
2L	50	2,58	10	008610213
3	25	1,33	10	008610215
4	25	3,55	10	008610220

861PH/C

pontas para parafusos de perfil Phillips®



ISO 2351-2

ISO 1173 C 6,3

PH	L mm	€	U	U
0	25	1,01	200	008610250
1	25	1,01	200	008610255
2	25	1,01	200	008610260
2L	50	1,95	100	008610263
3	25	1,01	200	008610265
4	25	2,62	100	008610270

861PZ

pontas para parafusos de perfil Pozidriv(R) - Supadriv(R)



ISO 2351-2

ISO 1173 C 6,3

PZ	L mm	€	U	U
1	25	1,33	10	008610300
2	25	1,33	10	008610305
2L	50	2,56	10	008610308
3	25	1,33	10	008610310
4	25	3,55	10	008610315



861PZ/C

pontas para parafusos de perfil Pozidriv® - Supadriv®



ISO 2351-2
ISO 1173 C 6,3

PZ	L mm	€	10	100
1	25	1,01	200	008610350
2	25	1,01	200	008610355
2L	50	1,95	100	008610358
3	25	1,01	200	008610360
4	25	2,58	100	008610365

861PE

pontas macho hexagonal



ISO 2351-3
ISO 1173 C 6,3

mm	L mm	€	10	100
2	25	1,42	10	008610100
2,5	25	1,42	10	008610105
3	25	1,42	10	008610110
4	25	1,42	10	008610115
5	25	1,42	10	008610120
6	25	1,42	10	008610125
8	25	2,15	10	008610130
10	25	2,84	10	008610135

861TX

pontas para parafusos de perfil Torx®



ISO 1173 C 6,3

T	L mm	€	10	100
T5	25	1,89	10	008610399
T6	25	1,89	10	008610400
T7	25	1,89	10	008610405
T8	25	1,89	10	008610410
T9	25	1,89	10	008610415
T10	25	1,48	10	008610420
T15	25	1,48	10	008610425
T20	25	1,48	10	008610430
T25	25	1,48	10	008610435
T27	25	1,48	10	008610440
T30	25	1,48	10	008610445
T40	25	1,48	10	008610450

861TX/C

pontas para parafusos de perfil Torx®

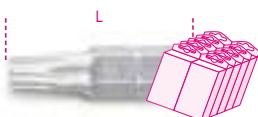

ISO 1173 C 6,3

T	L mm	€	200	1000
T10	25	1,14	200	008610470
T15	25	1,14	200	008610475
T20	25	1,14	200	008610480
T25	25	1,14	200	008610485
T27	25	1,14	200	008610490
T30	25	1,14	200	008610495
T40	25	1,14	200	008610499

861RTX

pontas para parafusos de perfil Tamper Resistant Torx(R)



ISO 1173 C 6,3

T	L mm	€	10	100
T6	25	2,79	10	008610537
T7	25	2,79	10	008610538
T8	25	2,79	10	008610540
T9	25	2,79	10	008610500
T10	25	2,79	10	008610505
T15	25	2,79	10	008610510
T20	25	2,79	10	008610515
T25	25	2,79	10	008610520
T27	25	2,79	10	008610525
T30	25	2,79	10	008610530
T40	25	2,79	10	008610535
T45	25	5,50	10	008610539

861RIBE

pontas para parafusos RIBE®



ISO 1173 C 6,3

M	L mm	€	10	100
M5	25	1,22	10	008610705
M6	25	1,22	10	008610706
M7	25	1,48	10	008610707
M8	25	1,48	10	008610708
M9	25	2,15	10	008610709

861TRW

pontas para parafusos de perfil Tri-Wing(R)



ISO 1173 C 6,3

GR	L mm	€	10	100
1	25	2,36	10	008610601
2	25	2,36	10	008610602
3	25	2,36	10	008610603
4	25	2,36	10	008610604
5	25	2,36	10	008610605
6	25	3,45	10	008610606

861TQS

pontas para parafusos de perfil Torq-Set(R)



ISO 1173 C 6,3

GR	L mm	€	10	100
0	25	2,36	10	008610620
1	25	2,36	10	008610621
2	25	2,36	10	008610622
3	25	2,36	10	008610623
4	25	2,36	10	008610624
5	25	2,36	10	008610625
6	25	2,36	10	008610626
8	25	2,36	10	008610628
10	25	2,36	10	008610630

861SP

pontas para parafusos de perfil Spanner



ISO 1173 C 6,3

SP	D mm	L mm	€	10	100
4	1,5	25	1,95	10	008610650
6	2,4	25	1,95	10	008610653
8	2,8	25	1,95	10	008610656
10	3,3	25	1,95	10	008610658
12	3,9	25	1,95	10	008610660

1483KV-PT/S7



1483KV PT/S7

185

861XZN

pontas para parafusos XZN®



ISO 1173 C 6,3

M	L mm	€	10	100
M5	25	1,22	10	008610725
M6	25	1,22	10	008610726
M8	25	1,56	10	008610728

861/C61P

61 pontas e 1 porta-pontas magnético de desengate rápido com punho

1/4



861/C61P € 182,00 1 008610978

	●	861LP	0,5x3 - 0,6x4,5 - 0,8x5,5 - 1,0x5,5 1,2x6,5 - 1,2x8 - 1,6x8 mm
	○	861PE	2 - 2,5 - 3 - 4 - 5 - 6 - 8 - 10 mm
	+	861PH	PH0 - PH1 - PH2 - PH3
	+	861PZ	PZ1 - PZ2 - PZ3
	⊕	861TX	T6 - T7 - T8 - T9 - T10 - T15 T20 - T25 - T27 - T30 - T40
	⊕	861RTX	T9 - T10 - T15 - T20 - T25 T27 - T30 - T40
	⊕	861TRW	1 - 2 - 3 - 4 - 5 - 6
	⊕	861TQS	0 - 1 - 2 - 3 - 4 - 5 - 6 - 8 - 10
	⊕	861SP	4 - 6 - 8 - 10 - 12
	○	851SR	○ 1/4"

270x120x45 mm - 975 g

862LP

pontas para parafusos de perfil de fenda

1/4



ISO 2351-1

ISO 1173 E 6,3

SxA mm	L mm	€	5	10
0,5x3	50	3,85	5	008620005
0,6x4,5	50	3,85	5	008620010
0,8x5,5	50	3,85	5	008620015
1x5,5	50	3,85	5	008620020
1,2x6,5	50	3,85	5	008620025
1,2x8	50	4,80	5	008620030
1,6x8	50	4,80	5	008620035

862PH

pontas para parafusos de perfil Phillips®

1/4



ISO 2351-2

ISO 1173 E 6,3

PH	L mm	€	5	10
1	50	3,85	5	008620200
2	50	3,85	5	008620205
3	50	3,85	5	008620210

862PH/L

pontas para parafusos de perfil Phillips®

1/4



ISO 2351-2

ISO 1173 E 6,3

PH	L mm	€	5	10
1	70	7,20	5	008620230
2	70	7,20	5	008620232
3	70	7,20	5	008620234

862PH-XL

Pontas para parafusos de perfil Phillips®

1/4



ISO 2351-2ISO 1173 E 6,3

PH	L mm	€	5	10
1	100	7,40	5	008620250
2	100	7,40	5	008620252
3	100	7,40	5	008620254

862PZ

pontas para parafusos de perfil Pozidriv® - Supadriv®

1/4



ISO 2351-2

ISO 1173 E 6,3

PZ	L mm	€	5	10
1	50	4,00	5	008620300
2	50	4,00	5	008620305
3	50	4,00	5	008620310

862PE

pontas macho hexagonal

1/4



ISO 2351-3

ISO 1173 E 6,3

mm	L mm	€	5	10
3	50	4,00	5	008620103
4	50	4,00	5	008620104
5	50	4,00	5	008620105
6	50	4,00	5	008620106
8	50	5,50	5	008620108

862TX

pontas para parafusos de perfil Torx®

1/4

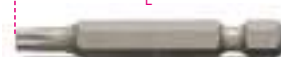

ISO 1173 E 6,3

T	L mm	€	5	10
T6	50	5,40	5	008620506
T7	50	5,40	5	008620507
T8	50	5,40	5	008620508
T9	50	5,40	5	008620509
T10	50	5,40	5	008620510
T15	50	5,40	5	008620515
T20	50	5,40	5	008620520
T25	50	5,40	5	008620525
T27	50	5,40	5	008620527
T30	50	5,40	5	008620530
T40	50	5,40	5	008620540

862TX/L

pontas para parafusos de perfil Torx®

1/4

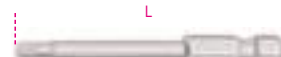

ISO 1173 E 6,3

T	L mm	€	5	10
T6	70	5,80	5	008620556
T7	70	5,80	5	008620557
T8	70	5,80	5	008620558
T9	70	5,80	5	008620559
T10	70	5,80	5	008620560
T15	70	5,80	5	008620565
T20	70	5,80	5	008620570
T25	70	5,80	5	008620575
T27	70	5,80	5	008620577
T30	70	5,80	5	008620580
T40	70	5,80	5	008620590

862TX-XL

Pontas para parafusos de perfil Torx®

1/4



ISO 1173 E 6,3

T	L mm	€	5	10
T9	100	6,40	5	008620659
T10	100	6,40	5	008620660
T15	100	6,40	5	008620665
T20	100	6,40	5	008620670
T25	100	6,40	5	008620675
T27	100	6,40	5	008620677
T30	100	6,40	5	008620680
T40	100	6,40	5	008620690



862F

pontas para chaves de caixa magnéticas



ISO 1173 E 6,3

mm	L mm	Ø mm	€		
5,5	65	11	7,30	5	008620405
6	65	11	7,30	5	008620406
7	65	11	7,30	5	008620407
8	65	13	7,30	5	008620408
10	65	15	8,00	5	008620410
12	65	18	8,80	5	008620412
13	65	18	9,30	5	008620413

862F/A7

Jogo de 7 bits sextavados magnéticos com chaves de caixa sextavadas em estojo de plástico



862F/A7 € 55,50 1 008620950

862F 5,5-6-7-8-10-12-13 mm

862XP/A16

16 pontas de impacto em estojo de bolso



862XP/A16 € 73,50 1 008620960

- ⊕ PH2(x2)-PH3
- ⊕ PZ2(x2)-PZ3
- ⊙ T20-T25(x2)
- ⊙ T30(x2)-T40(x2)
- ⊙ 4-5-6 mm

866LP

pontas para parafusos de fendas



ISO 2351-1
ISO 1173 C 8

SxA mm	L mm	€		
1x5,5	41	4,00	10	008660005
1,2x6,5	41	4,00	10	008660010
1,6x8	41	4,00	10	008660015
1,6x10	41	5,50	10	008660020
2x12	41	6,80	10	008660025

866PH

pontas para parafusos de perfil Phillips®



ISO 2351-2
ISO 1173 C 8

PH	L mm	€		
1	32	3,25	10	008660200
2	32	3,25	10	008660205
3	32	3,25	10	008660210
4	38	4,85	10	008660215

866PZ

pontas para parafusos de perfil Pozidriv® - Supadriv®



ISO 2351-2
ISO 1173 C 8

PZ	L mm	€		
1	32	3,40	10	008660300
2	32	3,40	10	008660305
3	32	3,40	10	008660310
4	38	5,10	10	008660315

866PE

pontas macho hexagonal



ISO 2351-3
ISO 1173 C 8

mm	L mm	€		
3	30	2,79	10	008660100
4	30	2,79	10	008660105
5	30	2,79	10	008660110
6	30	2,79	10	008660115
7	30	2,79	10	008660117
8	30	2,79	10	008660120
10	30	3,85	10	008660125
12	30	5,50	10	008660132
14	30	7,00	10	008660134

866TX

pontas para parafusos de perfil Torx®



ISO 1173 C 8

	L mm	€		
T20	30	3,50	10	008660400
T25	30	3,50	10	008660405
T27	30	3,50	10	008660410
T30	30	3,50	10	008660415
T40	30	3,50	10	008660420
T45	30	3,50	10	008660425
T50	30	3,50	10	008660430
T55	30	5,10	10	008660435
T60	30	6,80	10	008660440
T70	30	7,50	10	008660445

866RTX

pontas para parafusos de perfil Tamper Resistant Torx®



ISO 1173 C 8

	L mm	€		
T40	30	4,00	10	008660520
T45	30	4,00	10	008660525
T50	30	4,00	10	008660530
T55	30	5,70	10	008660535
T60	30	7,30	10	008660540
T70	30	9,10	10	008660545

867PE

pontas macho hexagonal



mm	L mm	€		
4	30	1,83	5	008670104
5	30	1,83	5	008670105
6	30	1,83	5	008670106
7	30	1,83	5	008670107
8	30	1,83	5	008670108
10	30	1,83	5	008670110
12	30	2,72	5	008670112

867PE/L

pontas hexagonais



mm	L mm	€		
4	75	3,40	5	008670154
5	75	3,40	5	008670155
6	75	3,40	5	008670156
7	75	3,40	5	008670157
8	75	3,40	5	008670158
10	75	3,40	5	008670160
12	75	4,75	5	008670162



867XZN

pontas para parafusos de perfil XZN®



Ø	L mm	€	5	10
M4	30	2,28	5	008670204
M5	30	2,28	5	008670205
M6	30	2,28	5	008670206
M8	30	2,28	5	008670208
M10	30	2,28	5	008670210
M12	30	3,40	5	008670212

867XZN/L

pontas com perfil XZN®



Ø	L mm	€	5	10
M5	75	3,70	5	008670255
M6	75	3,70	5	008670256
M8	75	3,70	5	008670258
M10	75	3,70	5	008670260
M12	75	5,10	5	008670262

867TX

pontas para parafusos de perfil Torx®



Ø	L mm	€	5	10
T20	30	1,83	5	008670400
T25	30	1,83	5	008670405
T30	30	1,83	5	008670410
T40	30	1,83	5	008670415
T45	30	1,83	5	008670420
T50	30	1,83	5	008670425
T55	30	1,83	5	008670430

867TX/L

pontas para parafusos de perfil Torx®



Ø	L mm	€	5	10
T20	75	2,98	5	008670450
T25	75	2,98	5	008670455
T30	75	2,98	5	008670460
T40	75	2,98	5	008670465
T45	75	2,98	5	008670470
T50	75	2,98	5	008670475
T55	75	2,98	5	008670480

867RTX

pontas para parafusos de perfil Tamper Resistant Torx®



Ø	L mm	€	5	10
T20	30	2,03	5	008670500
T25	30	2,03	5	008670505
T30	30	2,03	5	008670510
T40	30	2,03	5	008670515
T45	30	2,03	5	008670520
T50	30	2,03	5	008670525
T55	30	2,03	5	008670530

867RTX/L

pontas para parafusos de perfil Tamper Resistant Torx®



Ø	L mm	€	5	10
T20	75	3,40	5	008670550
T25	75	3,40	5	008670555
T30	75	3,40	5	008670560
T40	75	3,40	5	008670565
T45	75	3,40	5	008670570
T50	75	3,40	5	008670575
T55	75	3,40	5	008670580

867RIBE

pontas para parafusos RIBE®



Ø	L mm	€	5	10
M5	30	2,08	5	008670705
M6	30	2,08	5	008670706
M7	30	2,08	5	008670707
M8	30	2,08	5	008670708
M9	30	2,08	5	008670709
M10	30	2,08	5	008670710
M11	30	3,05	5	008670711
M12	30	3,05	5	008670712
M13	30	3,05	5	008670713

867RIBE/L

pontas para parafusos de perfil RIBE®



Ø	L mm	€	5	10
M5	75	3,40	5	008670755
M6	75	3,40	5	008670756
M7	75	3,40	5	008670757
M8	75	3,40	5	008670758
M9	75	3,40	5	008670759
M10	75	3,40	5	008670760
M11	75	4,60	5	008670761
M12	75	4,60	5	008670762
M13	75	4,60	5	008670763

867/...

chaves de caixa porta-pontas para artigos 867



	Ø mm	mm	L mm	Ø mm	€	5	10
867/1	10	3/8"	38	17	6,60	5	008670600
867/2	10	1/2"	38	22	7,40	5	008670601

867/C20

jogo 18 bits para parafusos RIBE®, com encabadouro sextavado 10 mm e 2 acessórios



867/C20	€	1	008670920
	130,00		

	867RIBE	5-6-7-8-9-10-11-12-13 mm
	867RIBE/L	5-6-7-8-9-10-11-12-13 mm
	867/1	
	867/2	
≡ 335x145x60 mm - 1,7 kg		

867/C38

Porta Bits com punho em T articulado, 38 sextavados 10 mm



867/C38	€	1	008670938
	239,00		

	852	10 mm
	867PE	4-5-6-7-8-10-12mm
	867PE/L	4-5-6-7-8-10-12mm
	867XZN	M5-M6-M8-M10-M12
	867XZN/L	M5-M6-M8-M10-M12
	867TX	T20-T25-T30-T40-T45-T50-T55
	867TX/L	T20-T25-T30-T40-T45-T50-T55
	882	
≡ 420x185x60 mm - 3 kg		

867/C52

jogo com 52 pontas,
com porta-pontas hexagonal de 10 mm
e 2 acessórios

10



867/C52 € 148,00 1 008670901

	○ 867PE	4-5-6-7-8-10-12 mm
	○ 867PE/L	4-5-6-7-8-10-12 mm
	○ 867XZN	M5-M6-M8-M10-M12
	○ 867XZN/L	M5-M6-M8-M10-M12
	⊕ 867TX	T20-T25-T30-T40-T45-T50-T55
	⊕ 867TX/L	T20-T25-T30-T40-T45-T50-T55
	⊕ 867RTX	T20-T25-T30-T40-T45-T50-T55
	⊕ 867RTX/L	T20-T25-T30-T40-T45-T50-T55
	867/1	○ 10 mm - □ 3/8"
	867/2	○ 10 mm - □ 1/2"

250x170x70 mm - 2,1 kg

852



852 1/4 79,116

882

porta-pontas com anel de retenção
para aparafusadoras



ISO 1173 E 6,3

L mm 57 1/4 1/4 11 € 18,30 5 008820001

882AN

caixa de velocidades, encabadouro sextavado
1/4"

- Para berbequins com veio 10 mm e 13 mm e chaves de impacto 1/4"
- Velocidade máx.: 3600 rpm
- Binário máx.: 30 Nm
- Porta-pontas com substituição rápida
- Relação: 1:1
- Ligação à ferramenta através de encabadouro sextavado 1/4" D6.3



ISO 1173 E 6,3
ISO 1173 C 6,3

L mm 137 1/4 1/4 € 79,00 1 008820090

882M1

porta-pontas magnético



ISO 1173 E 6,3

L mm 50 1/4 1/4 11 € 19,30 5 008820006

882M

porta-pontas magnético



ISO 1173 E 6,3

L mm 75 1/4 1/4 11 € 23,30 5 008820005

882MSR

porta-pontas magnético com desengate rápido
para aparafusadoras



ISO 1173 E 6,3

L mm 50 1/4 1/4 11 € 20,80 5 008820205
75 1/4 1/4 11 € 24,30 5 008820207

882P

extensão para porta-bits magnético



L mm 80 1/4 1/4 10 € 17,00 5 008820080



892

adaptadores para aparafusadoras



892/0
892/1
892/2
892/3
892/4
892/5
892/6
892/7

	■	●	L mm	€	5	008920000
892/0	1/4	1/4	25	6,00	5	008920000
* 892/1	1/4	5,5	50	11,40	5	008920001
* 892/2	3/8	5,5	50	16,90	5	008920002
° 892/3	1/4	1/4	50	11,40	5	008920003
° 892/4	3/8	1/4	50	16,90	5	008920004
892/5	1/4	5/16	75	15,70	5	008920005
892/6	3/8	5/16	75	23,00	5	008920006
892/7	1/2	1/4	75	23,80	5	008920007

* ISO 1173 A 5,5
° ISO 1173 C 6,3

895

chaves de caixa porta-pontas
refª s. 861 - 862 - 866



DIN 7427

	○	□	L mm	Ø mm	€	5	008950000
895/1	1/4	1/4	25,4	12	13,70	5	008950000
895/3	1/4	3/8	29	16,8	16,30	5	008950001
895/4	5/16	3/8	29	16,8	16,30	5	008950002
895/5	1/4	1/2	38	22	16,30	5	008950005
895/6	5/16	1/2	38	22	16,30	5	008950003

897

porta-pontas flexível com punho



L mm 280 L1 mm 154 € 31,00 2 008970010

897L

porta-pontas flexível com punho,
modelo longo



L mm 500 L1 mm 380 € 35,50 2 008970015

9XX/55 ROQUETES

Cabeça compacta



Para trabalhar em espaços confinados, a um ângulo não superior a 5°, graças à engrenagem de 72 dentes



Previne a movimentação ou desengate sob tensão

- A pressão da mão na cabeça do roquete não provoca inversão e permite sempre o retorno da alavanca
- Inversão com uma mão
- Excepcionais características mecânicas



Carga de trabalho reduzida, 17 dentes em contacto permanente com a engrenagem

900

chaves de caixa, boca sextavadas



UNI/ISO 2725 DIN 3124

Ø mm	Ø mm	L mm	Ø1 mm	€	U	U
3,2	6,6	25	11,8	4,45	10	009000032
4	6,8	25	11,8	4,45	10	009000040
4,5	7,4	25	11,8	4,45	10	009000045
5	8,0	25	11,8	4,45	10	009000050
5,5	8,7	25	11,8	4,45	10	009000055
6	9,3	25	11,8	4,45	10	009000060
7	10,4	25	11,8	4,45	10	009000070
8	11,8	25	12,7	4,45	10	009000080
9	12,7	25	11,8	4,45	10	009000090
10	14,2	25	12,0	4,45	10	009000100
11	15,8	25	12,5	4,45	10	009000110
12	17,2	25	13,5	4,45	10	009000120
13	18,0	25	13,5	4,50	10	009000130
14	20,0	25	15,0	4,55	10	009000140



900/SB13 79,50 € 1 009000150
4-4,5-5-5,5-6-7-8-9
10-11-12-13-14 mm

900MC

chaves de caixa sextavadas, coloridas



Ø mm	L mm	Ø mm	Ø1 mm	€	U	U
4	24,8	6,7	11,8	4,80	5	009002040
5	24,8	8,0	11,8	4,80	5	009002050
6	24,8	9,2	11,8	4,80	5	009002060
7	24,8	10,7	11,8	4,80	5	009002070
8	24,8	11,8	11,8	4,80	5	009002080
9	24,8	12,8	12,8	4,80	5	009002090
10	24,8	14,8	14,8	4,80	5	009002100
11	24,8	15,8	15,8	4,80	5	009002110
12	24,8	16,8	16,8	4,80	5	009002120
13	24,8	17,8	17,8	4,90	5	009002130
14	24,8	19,5	19,5	4,95	5	009002140



900MB

chaves de caixa boca de 12 faces



UNI/ISO 2725 DIN 3124

Ø mm	Ø mm	L mm	Ø1 mm	€	U	U
4	6,7	22	11,2	8,70	5	009000160
5	7,7	25	11,2	8,70	5	009000161
5,5	8,3	25	11,2	8,70	5	009000162
6	9,0	25	11,2	8,70	5	009000163
7	10,2	25	11,2	8,70	5	009000164
8	11,3	25	12,0	8,70	5	009000165
9	13,0	25	12,0	8,70	5	009000166
10	14,3	25	12,9	8,70	5	009000167
11	16,0	25	14,3	8,70	5	009000168
12	17,4	25	16,0	8,70	5	009000169
13	18,0	25	16,4	9,60	5	009000170
14	19,3	25	17,9	10,20	5	009000171



900MB/SB12 126,00 € 1 009000179
4-5-5,5-6-7-8-9-10
11-12-13-14 mm

900L

chaves de caixa série longa, boca sextavadas



UNI/ISO 2725 DIN 3124

Ø mm	Ø mm	L mm	Ø1 mm	€	U	U
4	6,5	50	12,0	10,50	5	009000181
4,5	7,0	50	12,0	10,50	5	009000182
5	7,5	50	12,0	10,50	5	009000183
5,5	8,5	50	12,0	10,50	5	009000184
6	9,5	50	12,0	10,50	5	009000185
7	10,5	50	12,0	10,50	5	009000186
8	12,0	50	12,0	10,50	5	009000187
9	13,0	50	13,0	10,50	5	009000188
10	14,0	50	14,0	10,90	5	009000189
11	16,0	50	16,0	10,90	5	009000190
12	17,5	50	17,5	10,90	5	009000191
13	17,5	50	17,5	10,90	5	009000192
14	20,0	50	20,0	10,90	5	009000193



900L/SB13 159,00 € 1 009000203
4-4,5-5-5,5-6-7-8-9-10-11-12-13-14 mm

900MB/L

chaves de caixa série longa,
boca de 12 faces



UNI/ISO 2725 DIN 3124

Ø mm	Ø mm	L mm	Ø1 mm	€	🔧	📄
5	8,0	50	12,0	16,10	3	009000211
6	9,3	50	12,0	16,10	3	009000212
7	10,9	50	12,0	16,10	3	009000213
8	11,6	50	12,0	16,10	3	009000214
9	13,0	50	12,0	16,10	3	009000215
10	14,3	50	12,8	17,10	3	009000216
11	16,0	50	14,2	17,10	3	009000217
12	17,4	50	15,5	17,10	3	009000218
13	18,0	50	16,2	17,30	3	009000219
14	19,0	50	17,1	17,60	3	009000220

900AS

chaves de caixa boca hexagonal



Ø mm	Ø mm	L mm	Ø1 mm	€	🔧	📄
5/32	8,8	25	11,9	4,90	5	009000349
3/16	7,7	25	11,9	4,90	5	009000340
7/32	8,8	25	11,9	4,90	5	009000345
1/4	9,6	25	11,9	4,90	5	009000350
9/32	10,2	25	11,9	4,90	5	009000355
5/16	11,3	25	11,9	4,90	5	009000360
11/32	12,7	25	11,6	4,90	5	009000365
3/8	14,0	25	12,9	4,90	5	009000370
7/16	15,3	25	14,5	4,90	5	009000375
1/2	17,5	25	16,4	4,95	5	009000380
9/16	19,0	25	17,9	5,10	5	009000385



900AS/SB11
3/16-7/32-5/32-1/4-9/32-5/16
11/32-3/8-7/16-1/2-9/16

€ 72,50 1 009000389

900AS/MB

chaves de caixa, boca de 12 faces



SAE AS 954E

Ø mm	Ø mm	L mm	Ø1 mm	€	🔧	📄
3/16	7,7	22	10,9	8,90	2	009000390
7/32	8,5	22	10,9	8,90	2	009000391
1/4	9,4	22	10,9	8,90	2	009000392
9/32	10,2	22	10,9	8,90	2	009000393
5/16	11,3	22	11,7	8,90	2	009000394
11/32	12,5	22	12,0	8,90	2	009000395
3/8	13,7	22	12,9	9,50	2	009000396

Ø mm	Ø mm	L mm	Ø1 mm	€	🔧	📄
7/16	15,6	22	14,3	9,50	2	009000397
1/2	17,2	22	16,4	10,50	2	009000398
9/16	18,8	24	17,9	10,60	2	009000399

900AS/L

chaves de caixa série longa,
boca hexagonal



SAE AS 954E

Ø mm	Ø mm	L mm	Ø1 mm	€	🔧	📄
3/16	7,0	50	12,0	10,90	2	009000301
7/32	8,5	50	12,0	10,90	2	009000303
1/4	9,8	50	12,0	10,90	2	009000305
9/32	10,5	50	12,0	10,90	2	009000307
5/16	12,0	50	12,0	10,90	2	009000309
11/32	13,0	50	13,0	10,90	2	009000311
3/8	14,0	50	14,0	10,90	2	009000313
7/16	16,0	50	16,0	10,90	2	009000315
1/2	17,5	50	17,5	10,90	2	009000317
9/16	20,0	50	20,0	11,70	2	009000319

900AS/MBL

chaves de caixa série longa,
boca de 12 faces



Ø mm	Ø mm	L mm	Ø1 mm	€	🔧	📄
5/32	6,8	50	12,0	16,90	2	009000325
3/16	8,0	50	12,0	16,90	2	009000326
7/32	8,5	50	12,0	16,90	2	009000327
1/4	9,8	50	12,0	16,90	2	009000328
9/32	10,9	50	12,0	16,90	2	009000329
5/16	11,6	50	12,0	16,90	2	009000330
11/32	13,0	50	12,0	16,90	2	009000331
3/8	14,3	50	12,8	18,10	2	009000332
7/16	16,0	50	14,2	18,10	2	009000333
1/2	18,0	50	16,2	18,10	2	009000334
9/16	19,0	50	17,1	18,10	2	009000335

900U

chaves de caixa para bloqueio/desbloqueio de
caixa de velocidades



Ø mm	"	Ø	Ø	€	🔧	📄
4	5/32	E5	M5	4,70	5	009001702
4,5	3/16	E6		4,70	5	009001703
5	13/64		M6	4,70	5	009001704
5,5	7/32	E7		4,70	5	009001705
6	1/4	E8	M8	4,70	5	009001706
7	9/32			4,70	5	009001707
8	5/16	E10	M10	4,70	5	009001708
9	11/32			4,70	5	009001709
10	3/8	E12	M12	4,70	5	009001710
11	7/16	E14	M14	4,70	5	009001711
12	15/32	E16		4,70	5	009001712
13	1/2		M16	4,75	5	009001713
14	9/16	E18	M18	4,80	5	009001714

1/4"



900U/SB13

4-4,5-5-5,5-6-7-8-9
10-11-12-13-14 mm

€ 82,00 1 009001750

900FTX

chaves de caixa para parafusos
com cabeça Torx®

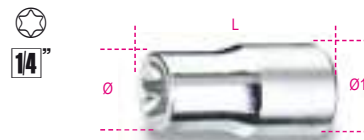

Ø mm	L mm	Ø1 mm	€	🔧	📄	
E4	5,4	22	11,2	8,30	5	009000404
E5	6,7	22	11,2	8,30	5	009000405
E6	7,7	22	11,2	8,30	5	009000406
E7	8,3	22	11,2	8,30	5	009000407
E8	9,6	22	11,2	8,30	5	009000408
E10	11,3	22	12,0	8,30	5	009000410
E11	12,1	22	12,5	11,40	5	009000411
E12	12,9	23	12,9	11,40	5	009000412
E14	14,0	25	14,0	11,40	5	009000414



900FTX/SB9

E4-E5-E6-E7-E8
E10-E11-E12-E14

€ 99,50 1 009000419

900LP

chaves de caixa com ponta
de perfil de fenda

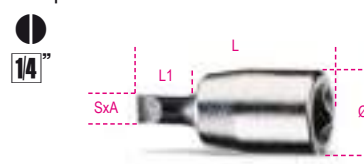

SxA mm	Ø mm	L mm	L1 mm	€	🔧	📄
0,8x4	12	28	9	10,10	5	009000605
1x5,5	12	28	9	10,10	5	009000610
1,2x6,5	12	28	9	10,10	5	009000615
1,2x8	13	28	8	10,10	5	009000620
1,6x10	14	28	8	10,10	5	009000625

900MC/LP

chaves de caixa com ponta de perfil de fenda,
coloridas



SxA mm	Ø mm	L mm	L1 mm	€	🔧	📄
0,8x4	12	28	9	15,70	3	009002605
1,2x6,5	12	28	9	15,70	3	009002615
1,2x8	13	28	8	15,70	3	009002620

900PH

chaves de caixa com ponta de perfil Phillips®

1/4"



PH	Ø mm	L mm	L1 mm	€	5	10
1	12	28	12	10,90	5	009000701
2	12	28	12	10,90	5	009000702
3	12	28	12	10,90	5	009000703
4	13	28	11	10,90	5	009000704

1/4"



900PH/SB4
PH1-PH2-PH3-PH4 € 53,00 1 009000708

900MC/PH

chave de caixa com ponta para parafusos Phillips®, coloridas

1/4"



PH	Ø mm	L mm	L1 mm	€	3	10
1	12	28	12	16,40	3	009002701
2	12	28	12	16,40	3	009002702
3	12	28	12	16,40	3	009002703

900PZ

chaves de caixa com ponta para parafusos Pozidriv®-Supadriv®

1/4"



PZ	Ø mm	L mm	€	3	10
1	12	28	11,50	3	009000711
2	12	28	11,50	3	009000712
3	12	28	11,50	3	009000713

900ME

chaves de caixa com ponta macho sextavadas

1/4"



mm	Ø mm	L mm	L1 mm	€	5	10
2,5	12	25	4,5	9,50	5	009000502
3	12	25	5,0	9,50	5	009000503
4	12	25	5,6	9,50	5	009000504
5	12	25	6,3	9,50	5	009000505
6	12	25	7,6	9,50	5	009000506
7	13	25	7,2	9,50	5	009000507
8	13	25	8,0	9,50	5	009000508
10	13	25	8,7	11,70	5	009000510

1/4"



900ME/SB8 € 92,50 1 009000518
2,5-3-4-5-6-7-8-10 mm

900PE/AS

chaves de caixa com ponta macho sextavada

1/4"



"	Ø mm	L mm	€	5	10
1/8	11,9	25	21,50	5	009000521
5/32	11,9	25	21,50	5	009000522
3/16	11,9	25	21,50	5	009000523
7/32	11,9	25	21,50	5	009000524
1/4	11,9	25	21,50	5	009000525
9/32	13,1	25	21,50	5	009000526
5/16	13,1	25	21,50	5	009000527

900PT

chaves de caixa com pontas de 5 nervuras e furo central

1/4"



PT	Ø mm	L mm	L1 mm	€	5	10
PT10	12	28	12	20,10	5	009000750
PT15	12	28	12	20,10	5	009000755
PT20	12	28	12	20,10	5	009000760
PT25	12	28	12	20,10	5	009000765
PT27	12	28	12	20,10	5	009000767
PT30	12	28	12	20,10	5	009000770

900TX

chaves de caixa com ponta macho de perfil Torx®

1/4"



T	Ø mm	L mm	L1 mm	€	5	10
T6	12	28	12	14,70	5	009000717
T7	12	28	12	14,70	5	009000718
T8	12	28	12	14,80	5	009000719
T9	12	28	12	14,80	5	009000720
T10	12	28	12	14,80	5	009000721
T15	12	28	12	14,80	5	009000722
T20	12	28	12	14,80	5	009000723
T25	12	28	12	14,80	5	009000724
T27	12	28	12	14,80	5	009000725
T30	12	28	12	14,80	5	009000726
T40	12	28	12	14,80	5	009000727

1/4"



900TX/SB8 € 132,00 1 009000730
T9-T10-T15-T20
T25-T27-T30-T40

900MC/TX

chaves de caixa com ponta de perfil Torx®, coloridas

1/4"



T	Ø mm	L mm	L1 mm	€	3	10
T10	12	28	12	16,90	3	009002721
T15	12	28	12	16,90	3	009002722
T20	12	28	12	16,90	3	009002723
T25	12	28	12	16,90	3	009002724
T27	12	28	12	16,90	3	009002725
T30	12	28	12	16,90	3	009002726
T40	12	28	12	16,90	3	009002727

900/16

adaptador quadra fêmea de 1/4" para quadra macho de 3/8"

1/4"



UNI/ISO 3316 DIN 3123

L mm	Ø mm	1/4"	3/8"	€	5	10
28	13,0	1/4"	3/8"	7,70	5	009000814

900/...

extensões com quadras macho e fêmea de 1/4"

1/4"

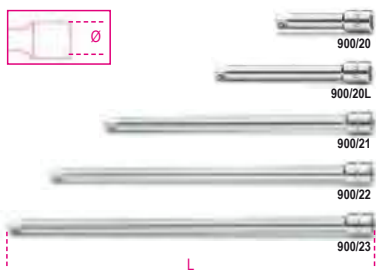

UNI/ISO 3316 DIN 3123

	L mm	Ø mm	€	5	009000818
900/20	50	11,5	9,80	5	009000818
900/20L	100	11,5	10,10	5	009000819
900/21	150	11,5	10,50	5	009000822
900/22	250	11,5	15,40	5	009000823
900/23	350	11,5	18,50	5	009000824

900AN

extensões com quadras macho angulares e fêmea de 1/4"

1/4"

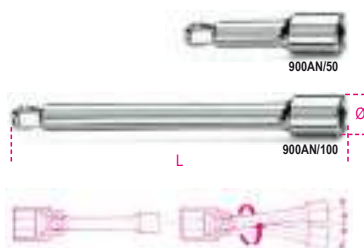

	L mm	Ø mm	€	3	009000825
900AN/50	50	11,5	10,60	3	009000825
900AN/100	100	11,5	11,70	3	009000826

900FL

extensão flexível com quadras macho e fêmea de 1/4"

1/4"



L mm	Ø mm	€	3	009000828
150	12	15,60	3	009000828

900/25

cardan com quadras macho e fêmea de 1/4"

1/4"



UNI/ISO 3316 DIN 3123

L mm	Ø mm	€	5	009000830
41	12,5	19,00	5	009000830

900BG/30C

extensão 1/4" com punho, série curta

1/4"



UNI/ISO 3315 DIN 3122

L mm	L1 mm	€	5	009000833
128	20	9,40	5	009000833

900BG/30

extensão 1/4" com punho

1/4"



UNI/ISO 3315 DIN 3122

L mm	L1 mm	€	5	009000834
176	68	9,80	5	009000834

900/32

extensão flexível com punho quadra macho de 1/4"

1/4"



L mm	L1 mm	€	2	009000839
280	154	22,50	2	009000839

900/35A

cabo articulado com punho quadra de 1/4"

1/4"



L mm	L1 mm	€	2	009000839
280	154	22,50	2	009000839

UNI/ISO 3315 DIN 3122

L mm	L1 mm	€	5	009000840
148	84	32,00	5	009000840

900M/35

cabo articulado com punho metálico quadra de 1/4"

1/4"



UNI/ISO 3315
DIN 3122

L mm	€	3	009000845
130	41,00	3	009000845



900/40

punho com cardan macho de 1/4"

1/4"



L mm	L1 mm	€	3	009000843
390	145	43,00	3	009000843

900/42

cabo T corrediço, quadra de 1/4"

1/4"



UNI/ISO 3315 DIN 3122

L mm	A mm	€	5	009000854
115	22	10,70	5	009000854

900T/44

chave macho quadrada 1/4" com punho

1/4"



L mm	L1 mm	€	2	009000860
238	105	16,20	2	009000860

900/55

roquete reversível quadra de 1/4" 48 dentes

1/4"



UNI/ISO 3315 DIN 3122

L mm	Ø mm	A mm	€	5	009000870
125	25	29	51,50	5	009000870

900/55Z

72

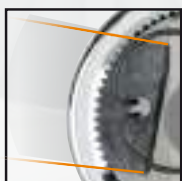

O roquete 900/55Z foi desenvolvido pelo Departamento Técnico da Beta com um novo mecanismo de 72 dentes, sendo que 15 estão em contacto permanente com a engrenagem. Assim, a carga de trabalho é distribuída por um v número de dentes, contribuindo para um reduzido desgaste dos componentes individuais e para uma longa vida útil.



Adicionalmente, os 72 dentes garantem um ângulo de penetração não superior a 5° e uma cabeça muito compacta, possibilitando assim um acesso rápido também a espaços confinados.

O punho ergonómico bi-material da Beta permite uma utilização rápida do roquete e a aplicação de maior força.

900/55Z

Roquete reversível com quadra de 1/4", 72 dentes

72
1/4"



L	Ø	A	€	📦	📄
mm 126	mm 25	mm 23	51,50	3	009000882

900M/55

roquete reversível com punho metálico quadra de 1/4"



UNI/ISO 3315 DIN 3122			€	📦	📄
L	Ø	A			
mm 110	mm 22	mm 18	66,00	3	009000905

Ver quadro depois do artigo 929/C8 para acessórios compatíveis usados

900/58

roquete reversível quadra de 1/4" com punho rotativo, 52 dentes

- Funcionamento através de punho rotativo
- Botão de desbloqueio da chave de caixa
- Sistema de inversão através de porca na cabeça do roquete
- Punho bi-material



L	Ø	A	€	📦	📄
mm 126	mm 28	mm 28,5	78,00	2	009000884

900/C39N

11 chaves de caixa sextavadas, 21 bits e 7 acessórios



900/C39N	€	📦	📄
	231,00	1	009000947

861LP	0,6x4,5 - 1,2x6,5 - 1,2x8 mm
861PH	PH1-PH2-PH3
861PZ	PZ1-PZ2-PZ3
861PE	2,5-3-4-5-6 mm
861RTX	T10-T15-T20-T25-T27-T30-T40
900	5-5,5-6-7-8-9-10-11-12-13-14 mm
900/20	50 mm
900/20L	100 mm
900/25	
900BG/30C	128 mm
892/0	
895/1	
900/55Z	126 mm

900/C39U

11 chaves de caixa, 21 bits e 7 acessórios



900/C39U	€	📦	📄
	233,00	1	009001947

861LP	0,6x4,5 - 1,2x6,5 - 1,2x8 mm
861PH	PH1-PH2-PH3
861PZ	PZ1-PZ2-PZ3
861PE	2,5-3-4-5-6 mm
861RTX	T10-T15-T20-T25-T27-T30-T40
900U	○ 5-5,5-6-7-8-9-10-11-12-13-14 mm * 3/16-13/64-7/32-1/4-9/32-5/16 11/32-3/8-7/16-15/32-1/2-9/16 ○ E6-E7-E8-E10-E12-E14-E16-E18 ○ M6-M8-M10-M12-M14-M16-M18
900/20	50 mm
900/20L	100 mm
900/25	
900BG/30C	128 mm
892/0	
895/1	
900/55Z	126 mm

900/C11

jogo com 11 chaves de caixa sextavadas, 20 pontas e 8 acessórios



900/C11	€	📦	📄
	251,00	1	009000971

861LP	0,5x3 - 0,8x5,5 1x5,5 - 1,2x6,5 mm
861PE	3 - 4 - 5 - 6 - 8 mm
861PH	0 - 1 - 2 - 3
861TX	T8 - T10 - T15 - T20 T25 - T30 - T40
895/1	
900	5 - 5,5 - 6 - 7 - 8 - 9 - 10 11 - 12 - 13 - 14 mm
900/16	□ 1/4 - ■ 3/8
900/20	50 mm
900/21	150 mm
900/25	
900BG/30	176 mm
900/42	
900/55	

📦 270x120x45 mm - 📦 1,2 kg

9899 900C11	€	📦	📄
Tabuleiro maleável, vazio	15,20	1	098990132

900/C11Z

conjunto de 11 chaves sextavadas, 20 bits e 8 acessórios

1/4"
1/4"



900/C11Z € 251,00 1 009000984

- 861LP 0,5x3 - 0,8x5,5 - 1x5,5 - 1,2x6,5 mm
- 861PE 3 - 4 - 5 - 6 - 8 mm
- 861PH 0 - 1 - 2 - 3
- 861TX T8 - T10 - T15 - T20
T25 - T30 - T40
- 895/1
- 900 5 - 5,5 - 6 - 7 - 8 - 9 - 10
11 - 12 - 13 - 14 mm
- 900/16 □ 1/4 - ■ 3/8
- 900/20 50 mm
- 900/21 150 mm
- 900/25
- 900BG/30 176 mm
- 900/42
- 900/55Z

350x150x50 mm - 1,2 kg

9899 900C11 € 15,20 1 098990132

Tabuleiro maleável, vazio

900/C12MR

Jogo de 12 chaves de caixa sextavadas, 20 pontas e 7 acessórios em módulo soft e caixa metálica

1/4"
1/4"



900/C12MR € 281,00 1 009000962

- 900 4-5-5,5-6-7-8-9-10-11-12-13-14 mm
- 900/20 50 mm
- 900/21 150 mm
- 900/25
- 900/42 115 mm
- 900BG/30 128 mm
- 900/58
- 895/1
- 861TX T8-T10-T15-T20-T25-T30-T40
- 861PH PH0-PH1-PH2-PH3
- 861LP 0,5-0,8-1-1,2 mm
- 861PE 3-4-5-6-8 mm

350x150x50 mm 1,3 kg



900/C12MZ

Jogo de 12 chaves de caixa sextavadas, 20 bits e 7 acessórios, em estojo metálico com módulo soft

1/4"
1/4"



900/C12MZ € 254,00 1 009000983

- 900 4-5-5,5-6-7-8-9-10-11-12-13-14 mm
- 900/20 50 mm
- 900/21 150 mm
- 900/25
- 900/42 115 mm
- 900BG/30 176 mm
- 900/55Z
- 895/1
- 861TX T8-T10-T15-T20-T25-T30-T40
- 861PH PH0-PH1-PH2-PH3
- 861LP 0,5x3 - 0,8x5,5 - 1x5,5 - 1,2x6,5 mm
- 861PE 3-4-5-6-8 mm

350x150x50 mm - 1,2 kg

900/C13-5

jogo com 13 chaves hexagonais e 5 acessórios

1/4"



900/C13-5 € 204,00 1 009000953

- 900 4 - 4,5 - 5 - 5,5 - 6 - 7 - 8 - 9
10 - 11 - 12 - 13 - 14 mm
- 900/21 150 mm
- 900/25
- 900BG/30
- 900/42
- 900/55

270x120x45 mm - 1 kg

9899 900/C13-5 € 15,20 1 098990131

Tabuleiro maleável, vazio

900/C13-8

jogo com 13 chaves hexagonais e 8 acessórios

1/4"



900/C13-8 € 247,00 1 009000954

- 900 4 - 4,5 - 5 - 5,5 - 6 - 7 - 8 - 9
10 - 11 - 12 - 13 - 14 mm
- 900/16 □ 1/4 - ■ 3/8
- 900/20 50 mm
- 900/21 150 mm
- 900/25
- 900BG/30
- 900/35A
- 900/42
- 900/55

270x120x45 mm - 1,1 kg

900MB/C19

jogo com 11 chaves de caixa de 12 faces e 8 acessórios

1/4"



900MB/C19 € 286,00 1 009000977

- 900MB 5 - 5,5 - 6 - 7 - 8 - 9 - 10 - 11
12 - 13 - 14 mm
- 900/16 □ 1/4 - ■ 3/8
- 900/20 50 mm
- 900/21 150 mm
- 900/25
- 900BG/30
- 900/35A
- 900/42
- 900/55

270x120x45 mm - 1,1 kg



900/C24

jogo com 13 chaves de caixa hexagonais, 11 pontas e 6 acessórios

1/4"



900/C24 € 317,00 1 009000956

- 900 4 - 4,5 - 5 - 5,5 - 6 - 7 - 8 - 9
10 - 11 - 12 - 13 - 14 mm
- 900LP 0,8x4 - 1,2x6,5 - 1,2x8 mm
- ⊕ 900PH PH1 - PH2 - PH3
- 900ME 3 - 4 - 5 - 6 - 8 mm
- 900/20 50 mm
- 900/21 150 mm
- 900/25
- 900BG/30
- 900/42
- ⊗ 900/55

270x120x45 mm - 1,1 kg

900MB/C28

jogo com 11 chaves de caixa de 12 faces, 11 pontas e 6 acessórios

1/4"



900MB/C28 € 357,00 1 009000979

- 900MB 5 - 5,5 - 6 - 7 - 8 - 9 - 10 - 11
12 - 13 - 14 mm
- 900LP 0,8x4 - 1,2x6,5 - 1,2x8 mm
- ⊕ 900PH PH1 - PH2 - PH3
- 900ME 3 - 4 - 5 - 6 - 8 mm
- 900/20 50 mm
- 900/21 150 mm
- 900/25
- 900BG/30
- 900/42
- ⊗ 900/55

270x120x45 mm - 1,1 kg

900MC/C24

11 chaves de caixa sextavadas, 13 pontas coloridas e 6 acessórios

1/4"



900MC/C24 € 417,00 1 009002960

- 900MC 4 - 5 - 6 - 7 - 8 - 9
10 - 11 - 12 - 13 - 14 mm
- ⊕ 900MC/PH PH1 - PH2 - PH3
- ⊗ 900MC/TX T10 - T15 - T20 - T25 - T27 - T30
- T40
- 900MC/LP 0,8x4 - 1,2x6,5 - 1,2x8 mm
- 900/20 50 mm
- 900/21 150 mm
- 900/25
- 900BG/30
- 900/42
- ⊗ 900/55

270x120x45 mm - 1 kg

900MC/C32

11 chaves de caixa sextavadas, 20 pontas coloridas e 7 acessórios

1/4"



900MC/C32 € 263,00 1 009002963

- 900MC 4 - 5 - 6 - 7 - 8 - 9 - 10 - 11 - 12 - 13
- 14 mm
- 860LP 0,5x3 - 0,8x5,5 -
1,0x5,5 - 1,2x6,5 mm
- ⊕ 860PH 0 - 1 - 2 - 3
- 860PE 3 - 4 - 5 - 6 - 8 mm
- ⊗ 860TX T8 - T10 - T15 - T20 - T25 - T30 - T40
- 895/1
- 900/20 50 mm
- 900/21 150 mm
- 900/25
- 900BG/30
- 900/42
- ⊗ 900/55

270x120x45 mm - 1,2 kg

900U/C12M

jogo 12 chaves de caixa para bloqueio/desbloqueio de caixa de velocidades, 20 bits e 7 acessórios, em módulo soft

1/4"

1/4"



900U/C12M € 257,00 1 009001792

- 900U ○ 4-5-5,5-6-7-8-9-10-11-12-13-14 mm
" 5/32-3/16-13/64-7/32-1/4-9/32-5/16
11/32-3/8-7/16-15/32-1/2-9/16
⊗ E5-E6-E7-E8-E10-E12-E14-E16-E18
○ M5-M6-M8-M10-M12-M14-M16-M18
- 900/20 50 mm
- 900/21 150 mm
- 900/25
- 900/42 115 mm
- 900BG/30 176 mm
- ⊗ 900/55 125 mm
- 895/1 ○ 1/4 - □ 1/4
- 861LP 0,5x3 - 0,8x5,5 - 1,0x5,5 - 1,2x6,5 mm
- 861PE 3-4-5-6-8 mm
- ⊕ 861PH PH0-PH1-PH2-PH3
- ⊗ 861TX T8-T10-T15-T20-T25-T30-T40

350x150x50 mm - 1,2 kg



900AS/C10 - /MB-C17

jogo com 10 chaves de caixa e 7 acessórios

1/4"



900AS/C10 € 230,00 1 009000961

	○ 900AS	3/16 - 7/32 - 1/4 - 9/32 - 5/16 11/32 - 3/8 - 7/16 - 1/2 - 9/16
	900/20	50 mm
	900/21	150 mm
	900/25	
	900BG/30	
	900/35A	
	900/42	
	900/55	

≡ 270x120x45 mm - 1,1 kg

900AS/MB-C17 € 274,00 1 009000981

	○ 900AS/MB	3/16 - 7/32 - 1/4 - 9/32 - 5/16 11/32 - 3/8 - 7/16 - 1/2 - 9/16
	900/20	50 mm
	900/21	150 mm
	900/25	
	900BG/30	
	900/35A	
	900/42	
	900/55	

≡ 270x120x45 mm - 1,1 kg

900AS/C17-MBM

jogo com 10 chaves de caixa com 12 faces e 7 acessórios

1/4"



900AS/C17-MBM € 297,00 1 009000982

	○ 900AS/MB	3/16 - 7/32 - 1/4 - 9/32 - 5/16 11/32 - 3/8 - 7/16 - 1/2 - 9/16
	900/20	50 mm
	900/21	150 mm
	900/25	
	900BG/30	
	900M/35	
	900/42	
	900M/55	

≡ 270x120x45 mm - 1,2 kg

900/C11HR

11 chaves de caixa sextavadas, 20 bits e 7 acessórios, em estojo metálico com tabuleiro rígido

• roquete com punho rotativo

1/4"

1/4"



900/C11HR € 278,00 1 009000980

	● 861LP	0,5x3-0,8x5,5-1x5,5-1,2x6,5 mm
	⊕ 861PH	PH0-PH1-PH2-PH3
	○ 861PE	3-4-5-6-8 mm
	⊖ 861TX	T8-T10-T15-T20-T25-T30-T40
	895/1	
	○ 900	5-5,5-6-7-8-9-10-11-12-13-14 mm
	900/16	□ 1/4 - ■ 3/8
	900/20	50 mm
	900/21	150 mm
	900/25	
	900/42	
	900BG/30	
	900/58	

≡ 350x150x50 mm - 1,3 kg

902R/C6

jogo de 6 conversores de quadra para chaves de caixa



902R/C6 € 123,00 1 009020814

	900/16	□ 1/4 - ■ 3/8
	910/15	□ 3/8 - ■ 1/4
	910/16	□ 3/8 - ■ 1/2
	920/15	□ 1/2 - ■ 3/8
	920/16	□ 1/2 - ■ 3/4
	928/15	□ 3/4 - ■ 1/2

≡ 170x100x35 mm - 600 g

902A/C22

Jogo de 22 chaves de caixa hexagonal e 6 acessórios em caixa metálica

1/4"

1/2"



902A/C22 € 399,00 1 009020807

	○ 900	5-5,5-6-7-8-9-10-11-12-13 mm
	900/20	50 mm
	900/25	
	1/4" 900/55	
	○ 920A	10-13-14-15-17-18-19 22-24-27-30-32 mm
	920/21	125 mm
	920/25	
	1/2" 920/55	

≡ 420x185x60 mm - 3,5 kg

9899 902A/C22 € 15,20 1 098990133

Tabuleiro maleável, vazio

910A

chaves de caixa, boca sextavadas



UNI/ISO 2725 DIN 3124

6	7	8	9	10	11	12	13	14	15	16	17	18	19	20	21	22
6	7	8	9	10	11	12	13	14	15	16	17	18	19	20	21	22
9,5	10,7	12,1	13,2	14,6	15,8	17,2	18,4	19,7	20,9	22,2	23,2	24,7	25,8	27,2	28,2	29,7
28	28	28	28	29	29	30	31	32	32	33	33	34	35	35	36	37
16,7	16,7	16,7	16,7	16,7	16,7	17,7	17,0	17,5	18,0	18,5	19,0	20,0	21,0	22,0	23,0	24,0
7,00	7,00	7,00	7,00	7,00	7,00	7,30	7,30	7,30	7,30	8,20	8,20	8,20	8,20	8,70	8,70	9,00
5 009100006	5 009100007	5 009100008	5 009100009	5 009100010	5 009100011	5 009100012	5 009100013	5 009100014	5 009100015	5 009100016	5 009100017	5 009100018	5 009100019	5 009100020	5 009100021	5 009100022



910A/SB17 € 156,00 1 009100030

6-7-8-9-10-11-12
13-14-15-16-17
18-19-20-21-22 mm

910B

chaves de caixa, boca de 12 faces

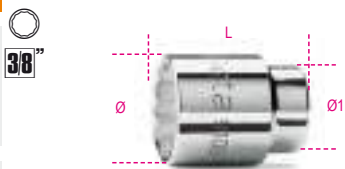

UNI/ISO 2725 DIN 3124

mm	Ø	L	Ø1	€	U	PC
6	9,5	28	16,7	7,00	5	009100106
7	10,7	28	16,7	7,00	5	009100107
8	12,1	28	16,7	7,00	5	009100108
9	13,2	28	16,7	7,00	5	009100109
10	14,6	29	16,7	7,00	5	009100110
11	15,8	29	16,7	7,00	5	009100111
12	17,2	30	17,7	7,30	5	009100112
13	18,4	31	17,0	7,30	5	009100113
14	19,7	32	17,5	7,30	5	009100114
15	20,9	32	18,0	7,30	5	009100115
16	22,2	33	18,5	8,20	5	009100116
17	23,2	33	19,0	8,20	5	009100117
18	24,7	34	20,0	8,20	5	009100118
19	25,8	35	21,0	8,20	5	009100119
20	27,2	35	22,0	8,70	5	009100120
21	28,2	36	23,0	8,70	5	009100121
22	29,7	37	24,0	9,00	5	009100122



910B/SB17 156,00 1 009100130
6-7-8-9-10-11-12
13-14-15-16-17
18-19-20-21-22 mm

910AL

chaves de caixa série longa,
boca hexagonal



UNI/ISO 2725 DIN 3124

mm	Ø	L	Ø1	€	U	PC
8	12,0	55	17	15,00	3	009100158
9	13,0	55	17	15,00	3	009100159
10	14,5	55	17	15,00	3	009100160
11	16,0	55	17	15,00	3	009100161
12	17,0	55	17	15,00	3	009100162
13	18,0	55	17	16,40	3	009100163
14	20,0	55	18	16,40	3	009100164
15	21,0	55	20	16,40	3	009100165
16	22,0	55	20	16,40	3	009100166
17	23,5	55	22	16,40	3	009100167
18	24,5	55	23	17,90	2	009100168
19	25,0	55	24	17,90	2	009100169
21	27,0	65	26	19,20	2	009100171
22	29,0	65	28	19,20	2	009100172



910AL/SB14 253,00 1 009100174
8-9-10-11-12-13-14
15-16-17-18-19-21-22 mm

910BL

chaves de caixa série longa,
boca de 12 faces



UNI/ISO 2725 DIN 3124

mm	Ø	L	Ø1	€	U	PC
8	12,0	55	17	15,00	3	009100308
9	13,0	55	17	15,00	3	009100309
10	14,5	55	17	15,00	3	009100310
11	16,0	55	17	15,00	3	009100311
12	17,0	55	17	15,00	3	009100312
13	18,0	55	17	16,40	3	009100313
14	20,0	55	18	16,40	3	009100314
15	21,0	55	20	16,40	3	009100315
16	22,0	55	20	16,40	3	009100316
17	23,5	55	22	16,40	3	009100317
18	24,5	55	23	17,90	2	009100318
19	25,0	55	24	17,90	2	009100319
21	27,0	65	26	19,20	2	009100321
22	29,0	65	28	19,20	2	009100322



910BL/SB14 253,00 1 009100340
8-9-10-11-12-13
14-15-16-17-18
19-21-22 mm

910B/SN

chaves de caixa articuladas
com boca de 12 faces

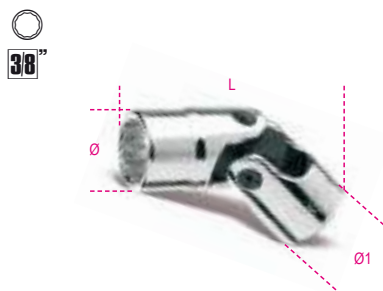

mm	Ø	L	Ø1	€	U	PC
10	14,5	48,5	19	38,50	2	009100230
11	15,8	49,5	19	38,50	2	009100231
12	17,0	50,0	19	38,50	2	009100232
13	18,3	51,0	19	38,50	2	009100233
14	19,5	51,0	19	43,00	2	009100234
15	20,8	53,5	19	43,00	2	009100235
16	22,0	53,5	19	43,00	2	009100236
17	23,3	54,5	19	43,00	2	009100237
18	24,5	54,5	19	43,00	2	009100238
19	25,8	56,5	19	43,00	2	009100239

910A/AS

chaves de caixa, boca hexagonal



mm	Ø	L	Ø1	€	U	PC
1/4	10,3	26	17,3	8,40	5	009100276
5/16	11,9	26	17,3	8,40	5	009100278
11/32	13,3	26	17,3	8,40	5	009100279
3/8	13,9	26	17,3	8,40	5	009100280
7/16	15,8	26	17,3	8,40	5	009100281
1/2	17,9	26	17,3	8,60	5	009100283
9/16	19,5	27	18,5	8,60	5	009100284
19/32	20,6	27	19,5	8,60	5	009100285
5/8	21,9	28	20,0	9,30	5	009100286
11/16	24,6	30	22,5	9,30	5	009100287
3/4	25,9	30	23,5	9,30	5	009100289
13/16	27,9	32	26,0	10,50	5	009100291
7/8	29,6	32	26,5	10,80	5	009100292



910A-AS/SB13 138,00 1 009100295
1/4-5/16-11/32-3/8-7/16
1/2-9/16-19/32-5/8-11/16
3/4-13/16-7/8

910AS

chaves de caixa, boca de 12 faces



mm	Ø	L	Ø1	€	U	PC
1/4	9,5	28	16,7	8,40	5	009100201
5/16	12,1	28	16,7	8,40	5	009100202
11/32	13,2	28	16,7	8,40	5	009100203
3/8	14,6	29	16,7	8,40	5	009100204
7/16	15,8	29	16,7	8,40	5	009100205
1/2	18,4	31	17,0	8,60	5	009100206
9/16	19,7	32	17,5	8,60	5	009100207
19/32	20,9	32	18,0	8,60	5	009100208
5/8	22,2	33	18,5	9,30	5	009100209
11/16	24,7	34	20,0	9,30	5	009100210
3/4	25,8	35	21,0	9,30	5	009100211
13/16	28,2	36	23,0	10,50	5	009100212
7/8	29,7	37	24,0	10,80	5	009100213



910AS/SB13 138,00 1 009100215
1/4-5/16-11/32-3/8-7/16
1/2-9/16-19/32-5/8-11/16
3/4-13/16-7/8

910AS/L

chaves de caixa série longa,
boca de 12 faces

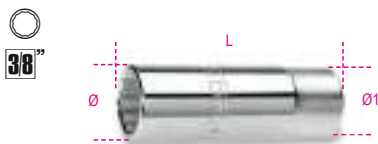

"	Ø mm	L mm	Ø1 mm	€		
1/4	10	55	17	18,90	3	009100350
5/16	12	55	17	18,90	3	009100351
3/8	14	55	17	18,90	3	009100352
7/16	16	55	17	18,90	3	009100353
1/2	18	55	17	21,00	3	009100354
9/16	20	55	18	21,00	3	009100355
19/32	21	55	20	21,50	3	009100356
5/8	22	55	20	21,50	3	009100357
11/16	23	55	22	21,50	3	009100359
3/4	25	55	24	22,90	3	009100360
13/16	27	65	26	26,50	3	009100362
7/8	29	65	28	26,50	3	009100363



		€		
910ASL/SB12		278,00	1	009100365
1/4-5/16-3/8-7/16				
1/2-9/16-19/32-5/8-11/16				
3/4-13/16-7/8				

910AS/SN

chaves de caixa articuladas
com boca de 12 faces

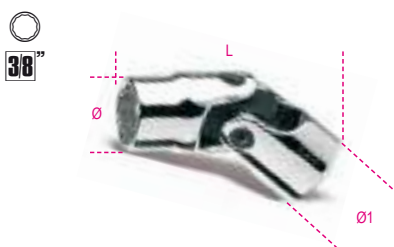

* SAE AS 954E

"	Ø mm	L mm	Ø1 mm	€		
* 3/8	14,0	48,0	19	42,50	2	009100260
* 7/16	15,8	51,0	19	42,50	2	009100261
* 1/2	18,3	51,0	19	42,50	2	009100262
* 9/16	19,5	51,0	19	43,00	2	009100263
* 5/8	22,0	53,5	19	43,00	2	009100264
11/16	24,5	54,5	19	46,00	2	009100265
3/4	25,8	56,5	19	46,00	2	009100266

910FTX

chaves de caixa para parafusos
de perfil Torx®

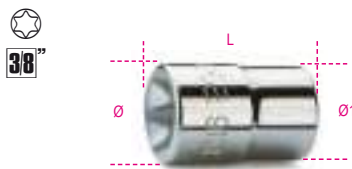

"	Ø mm	L mm	Ø1 mm	€		
E4	6,2	26	17,3	10,10	5	009100404
E5	7,0	26	17,3	10,10	5	009100405
E6	8,3	26	17,3	10,10	5	009100406
E7	8,9	26	17,3	10,10	5	009100407
E8	9,9	26	17,3	10,10	5	009100408
E10	12,0	26	17,3	10,10	5	009100410
E11	13,3	26	17,3	10,10	5	009100411
E12	14,5	26	17,3	10,10	5	009100412
E14	15,8	26	17,3	10,10	5	009100414
E16	18,0	26	17,3	10,10	5	009100416
E18	19,5	26	18,5	11,10	3	009100418
E20	21,9	26	20,0	11,10	3	009100420



		€		
910FTX/SB9		106,00	1	009100430
E4-E5-E6-E7-E8				
E10-E12-14-E16				

910FTX/L

chaves de caixa série longa
para parafusos de perfil Torx®



"	Ø mm	L mm	Ø1 mm	€		
E4	6,2	55	17,3	22,60	3	009100440
E5	7,0	55	17,3	22,60	3	009100441
E6	8,3	55	17,3	22,60	3	009100442
E7	8,9	55	17,3	22,60	3	009100443
E8	9,9	55	17,3	22,60	3	009100444
E10	12,0	55	17,3	22,60	3	009100445



		€		
910FTX-L/SB6		148,00	1	009100449
E4-E5-E6				
E7-E8-E10				

910FTX/XL

chaves de caixa para parafusos de perfil
Torx®, série extra-longa



"	Ø mm	L mm	Ø1 mm	€		
E6	8,0	200	18	20,30	2	009100766
E7	8,0	200	18	20,30	2	009100767
E8	10,0	200	18	20,30	2	009100768
E10	14,0	200	18	20,30	2	009100770
E11	14,0	200	18	20,30	2	009100771
E12	14,0	200	18	20,30	2	009100772

"	Ø mm	L mm	Ø1 mm	€		
E14	17,0	200	18	22,20	2	009100774
E16	18,6	200	18	22,20	2	009100776
E18	21,5	200	18	23,50	2	009100778
E20	21,5	200	18	23,50	2	009100780

910FTX-XL/C10

Conjunto de 10 chaves de caixa para
parafusos com perfil Torx®, série longa, em
caixa de plástico



		€		
910FTX/XL-C10		213,00	1	009100976
E6-E7-E8-E10-E11-				
E12-E14-E16-E18-E20				

255x195x62 mm - 2,3 kg

910LP

chaves de caixa com ponta
de perfil de fenda



SxA mm	Ø mm	L mm	L1 mm	€		
1x5,5	18,5	54	24	17,70	2	009100452
1,2x6,5	18,5	54	24	17,70	2	009100453
1,2x8	18,5	54	24	17,70	2	009100454
1,6x9	18,5	54	24	17,70	2	009100456

910PH

chaves de caixa com ponta
de perfil Phillips®



PH	Ø mm	L mm	L1 mm	€		
1	18,5	48	18	16,50	2	009100471
2	18,5	48	18	16,50	2	009100472
3	18,5	48	18	16,50	2	009100473
4	18,5	48	18	16,50	2	009100474



		€		
910PH/SB4		75,50	1	009100478
PH1-PH2-PH3-PH4				



910PE

chaves de caixa com ponta macho hexagonal



DIN 7422

mm	Ø mm	L mm	L1 mm	€	🔧	📦
3	18,5	50	20	14,40	5	009100490
4	18,5	50	20	14,40	5	009100492
5	18,5	50	20	14,40	5	009100494
6	18,5	50	20	14,40	5	009100496
7	18,5	50	20	14,40	5	009100497
8	18,5	50	20	14,40	5	009100498
9	18,5	50	20	14,40	5	009100499
10	18,5	50	20	14,40	5	009100500



910PE/SB7
3-4-5-6-7-8-10 mm

€ 114,00 1 009100503

910BP

Chaves de caixa com ponta macho sextavada



mm	L mm	L1 mm	€	🔧	📦
4L	92	62	17,20	3	009100584
5L	92	62	17,20	3	009100585
6L	92	62	17,20	3	009100586
7L	92	62	17,20	3	009100587
8L	92	62	17,20	3	009100588
10L	132	102	18,60	3	009100590



910BP/SB6L
4L-5L-6L-7L-8L-10L mm

€ 117,00 1 009100596

910ME

chaves de caixa com ponta macho hexagonal



mm	Ø mm	L mm	L1 mm	€	🔧	📦
4	18	62	15	17,30	5	009100504
5	18	62	15	17,30	5	009100505
6	18	62	15	17,30	5	009100506
7	18	62	15	17,60	5	009100507
8	19	62	15	17,60	5	009100508
10	20	62	15	17,60	5	009100510
12	20	62	15	17,60	5	009100512



910ME/SB5
4-5-6-8-10 mm

€ 98,00 1 009100515

910PE/AS

chaves de caixa para parafusos sextavados



"	Ø mm	L mm	L1 mm	€	🔧	📦
1/8	18,5	50	20	24,70	2	009100531
5/32	18,5	50	20	24,70	2	009100532
3/16	18,5	50	20	24,70	2	009100533
7/32	18,5	50	20	24,70	2	009100534
1/4	18,5	50	20	24,70	2	009100535
5/16	18,5	50	20	24,70	2	009100536
3/8	18,5	50	20	27,50	2	009100537

910PT

chaves de caixa com pontas de 5 nervuras e furo central



"	Ø mm	L mm	L1 mm	€	🔧	📦
PT40	20	50	20	22,90	3	009100540
PT45	20	50	20	23,50	3	009100545
PT50	20	50	20	28,00	3	009100550



910PT/SB8
PT10-PT15-PT20-PT25
PT30-PT40-PT45-PT50

€ 189,00 1 009100558

910TX

chaves de caixa com ponta macho de perfil Torx®



"	Ø mm	L mm	L1 mm	€	🔧	📦
T15	18,5	50	20	18,90	5	009100519
T20	18,5	50	20	18,90	5	009100520
T25	18,5	50	20	18,90	5	009100521
T27	18,5	50	20	18,90	5	009100522
T30	18,5	50	20	18,90	5	009100523
T40	18,5	50	20	18,90	5	009100524
T45	18,5	50	20	18,90	3	009100525
T50	18,5	50	20	18,90	3	009100526



910TX/SB6
T15-T20-T25
T27-T30-T40

€ 125,00 1 009100530

910XZN

chaves de caixa perfil XZN®



"	L mm	€	🔧	📦
M4	50	20,30	3	009100559
M5	50	20,30	3	009100560
M6	50	20,30	3	009100561
M8	50	20,30	3	009100563
M10	50	21,50	3	009100565

910CF

chaves pé de galo quadra fêmea de 3/8"



"	A mm	L mm	€	🔧	📦
10	21,3	32,3	12,30	2	009100135
11	23,1	34,3	12,30	2	009100136
12	25,5	36,2	13,80	2	009100137
13	26,9	37,4	13,80	2	009100138
14	30,2	40,0	14,70	2	009100139
15	33,3	41,3	15,30	2	009100140
16	33,3	41,3	16,60	2	009100141
17	38,1	46,5	19,20	2	009100142
18	38,1	46,5	19,20	2	009100143
19	39,6	48,0	21,00	2	009100144



910CF/SB10
10-11-12-13-14-15
16-17-18-19 mm

€ 175,00 1 009100147

910/15

redução quadra fêmea de 3/8" para quadra macho de 1/4"



UNI/ISO 3316 DIN 3123

L mm	Ø mm	🔧	📦
30	17,0	3/8 1/4	5 009100810



Aplique sempre uma força de aperto regular e progressiva, a fim de evitar a ruptura do material e de se proteger de um possível acidente

910/16

adaptador quadra fêmea de 3/8"
para quadra macho de 1/2"



UNI/ISO 3316 DIN 3123

L	Ø	€	3	5
mm	mm			
32	18,0	11,10	3	5

910/20 - 910/21 - 910/22

extensões com quadras macho
e fêmea de 3/8"

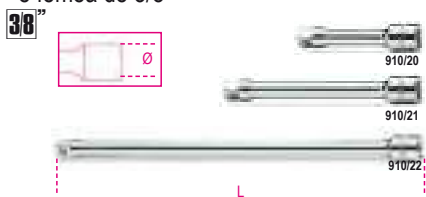

UNI/ISO 3316 DIN 3123

	L	Ø	€	3	5
	mm	mm			
910/20	75	17	9,10	3	5
910/21	125	17	13,10	3	5
910/22	250	17	17,30	3	5

910AN

extensões com quadras macho
angulares e fêmea de 3/8"

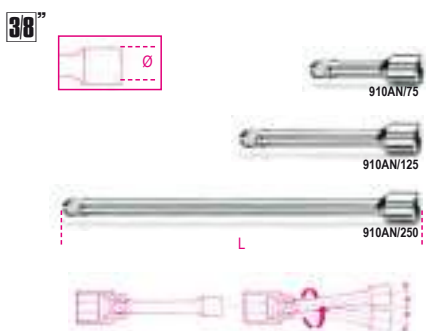

	L	Ø	€	3	5
	mm	mm			
910AN/75	75	17	12,90	3	5
910AN/125	125	17	16,10	3	5
910AN/250	250	17	24,00	3	5

910/25

cardan com quadras macho e fêmea
de 3/8"



UNI/ISO 3316 DIN 3123

L	Ø	€	3	5
mm	mm			
54,6	19	23,70	3	5

910M/35

cabo articulado com punho metálico,
quadra de 3/8"



UNI/ISO 3315 DIN 3122

L	€	3	5
mm			
250	65,50	3	5

910/36A

cabo articulado com punho quadra de 3/8"

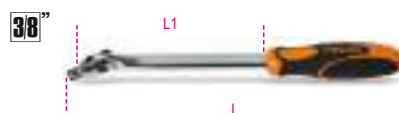

UNI/ISO 3315 DIN 3122

L	L1	€	3	5
mm	mm			
255	154	46,00	3	5

910/40

extensão articulada com punho em T
quadra de 3/8"



L	L1	€	3	5
mm	mm			
420	175	49,00	3	5

910/42

cabo T corrediço, quadra de 3/8"

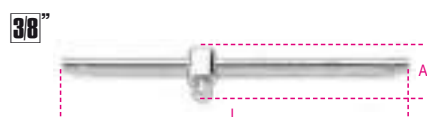

UNI/ISO 3315 DIN 3122

L	A	€	3	5
mm	mm			
210	30,5	15,60	3	5

910/46

manivela quadra macho de 3/8"

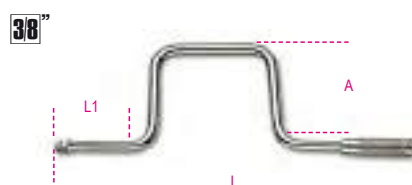

UNI/ISO 3315 DIN 3122

L	L1	A	€	3	5
mm	mm	mm			
315	80	115	30,50	3	5

910/55

roquete reversível, quadra de 3/8"
72 dentes



UNI/ISO 3315 DIN 3122

L	Ø	A	€	3	5
mm	mm	mm			
200	30	33	56,00	3	5

910/55Q

roquete reversível, quadra de 3/8"
48 dentes



UNI/ISO 3315 DIN 3122

L	Ø	A	€	3	5
mm	mm	mm			
200	30	33	56,00	3	5

Ver quadro depois do artigo 929/C8
para acessórios compatíveis usados

910M/55

roquete reversível com punho metálico
quadra de 3/8"



DIN 3122 - UNI ISO 3315

L	Ø	A	€	3	5
mm	mm	mm			
178	30	26	76,50	3	5



910M/56

roquete reversível articulado
com punho metálico, quadra de 3/8"



L	Ø	A	€		
mm	mm	mm			
265	31	29	105,00	2	009100887

910/58

roquete reversível quadra 3/8"
com punho rotativo,
52 dentes

- Funcionamento através de punho rotativo
- Botão de desbloqueio da chave de caixa
- Sistema de inversão através de porca na cabeça do roquete
- Punho bi-material



L	Ø	A	€		
mm	mm	mm			
222	37	38,5	86,00	1	009100884

910.../C10

jogo com 10 chaves de caixa
e 2 acessórios



910A/C10	180,00	1	009100909
----------	--------	---	-----------

910A	6 - 7 - 8 - 10 - 11 - 12 13 - 14 - 17 - 19 mm
910/21	125 mm
910/55	
335x120x45 mm - 1,3 kg	

910B/C10	180,00	1	009100910
----------	--------	---	-----------

910B	6 - 7 - 8 - 10 - 11 - 12 13 - 14 - 17 - 19 mm
910/21	125 mm
910/55	
335x120x45 mm - 1,3 kg	

910A/C16...

jogo com 16 chaves de caixa de 12 faces
e 5 acessórios



910A/C16	290,00	1	009100936
----------	--------	---	-----------

910A	6 - 7 - 8 - 9 - 10 - 11 - 12 - 13 14 - 15 - 16 - 17 - 18 - 19 21 - 22 mm
910/21	125 mm
910/22	250 mm
910/25	
910/42	
910/55	
335x145x60 mm - 2,3 kg	

9899 910C16	15,20	1	098990134
Tabuleiro maleável, vazio			

910A/C16Q	290,00	1	009100932
-----------	--------	---	-----------

910A	6 - 7 - 8 - 9 - 10 - 11 - 12 - 13 14 - 15 - 16 - 17 - 18 - 19 21 - 22 mm
910/21	125 mm
910/22	250 mm
910/25	
910/42	
910/55Q	
335x145x60 mm - 2,3 kg	

9899 910C16	15,20	1	098990134
Tabuleiro maleável, vazio			

910B/C16...

jogo com 16 chaves de caixa de 12 faces
e 5 acessórios



910B/C16	290,00	1	009100937
----------	--------	---	-----------

910B	6 - 7 - 8 - 9 - 10 - 11 - 12 - 13 14 - 15 - 16 - 17 - 18 - 19 21 - 22 mm
910/21	125 mm
910/22	250 mm
910/25	
910/42	
910/55	
335x145x60 mm - 2,3 kg	

9899 910C16	15,20	1	098990134
Tabuleiro maleável, vazio			

910B/C16Q	290,00	1	009100933
-----------	--------	---	-----------

910B	6 - 7 - 8 - 9 - 10 - 11 - 12 - 13 14 - 15 - 16 - 17 - 18 - 19 21 - 22 mm
910/21	125 mm
910/22	250 mm
910/25	
910/42	
910/55Q	
335x145x60 mm - 2,3 kg	

9899 910C16	15,20	1	098990134
-------------	-------	---	-----------

Tabuleiro maleável, vazio

910A/C17

jogo com 17 chaves de caixa hexagonais
e 9 acessórios



910A/C17	434,00	1	009100938
----------	--------	---	-----------

910A	6 - 7 - 8 - 9 - 10 - 11 - 12 - 13 14 - 15 - 16 - 17 - 18 - 19 - 20 21 - 22 mm
910/15	□ 3/8 - ■ 1/4
910/16	□ 3/8 - ■ 1/2
910/21	125 mm
910/22	250 mm
910/25	
910/36A	
910/42	
910/46	
910/55	
420x280x60 mm - 4,0 kg	



910.../C29

jogo com 17 chaves de caixa,
12 pontas e 5 acessórios

38"



910A/C29 € 498,00 1 009100944

- 910A 6 - 7 - 8 - 9 - 10 - 11 - 12 - 13
14 - 15 - 16 - 17 - 18 - 19 - 20
21 - 22 mm
- 910LP 1x5,5 - 1,2x6,5 - 1,2x8 mm
- ⊕ 910PH PH1 - PH2 - PH3
- 910PE 3 - 4 - 5 - 6 - 8 - 10 mm
- 910/21 125 mm
- 910/22 250 mm
- 910/25
- 910/42
- ⊗ 910/55

420x185x60 mm - 3,5 kg

910B/C29 € 498,00 1 009100945

- 910B 6 - 7 - 8 - 9 - 10 - 11 - 12 - 13
14 - 15 - 16 - 17 - 18 - 19 - 20
21 - 22 mm
- 910LP 1x5,5 - 1,2x6,5 - 1,2x8 mm
- ⊕ 910PH PH1 - PH2 - PH3
- 910PE 3 - 4 - 5 - 6 - 8 - 10 mm
- 910/21 125 mm
- 910/22 250 mm
- 910/25
- 910/42
- ⊗ 910/55

420x185x60 mm - 3,5 kg

910AS/C13...

jogo com 13 chaves de caixa de 12 faces
e 5 acessórios

38"



910AS/C13 € 294,00 1 009100925

- 910AS 1/4 - 5/16 - 11/32 - 3/8 - 7/16
1/2 - 9/16 - 19/32 - 5/8 - 11/16
3/4 - 13/16 - 7/8
- 910/21 125 mm
- 910/22 250 mm
- 910/42
- 910/25
- ⊗ 910/55

335x145x60 mm - 2,3 kg

910AS/MBM-C18

jogo com 13 chaves de caixa de 12 faces
e 5 acessórios

38"



910AS/MBM-C18 € 306,00 1 009100926

- 910AS 1/4 - 5/16 - 11/32 - 3/8 - 7/16
1/2 - 9/16 - 19/32 - 5/8 - 11/16
3/4 - 13/16 - 7/8
- 910/21 125 mm
- 910/22 250 mm
- 910/25
- 910/42
- 910M/55

335x145x60 mm - 2,5 kg

910A/C16HR

Jogo de 16 chaves de caixa sextavadas e 5
acessórios em módulo soft e caixa metálica

• roquete com punho rotativo

38"



910A/C16HR € 320,00 1 009100935

- 910A 6 - 7 - 8 - 9 - 10 - 11 - 12 - 13
14 - 15 - 16 - 17 - 18 - 19
21 - 22 mm
- 910/21 125 mm
- 910/22 250 mm
- 910/25
- 910/42 210 mm
- 910/58

335x145x60 mm - 2,4 kg

Beta

920A

chaves de caixa boca sextavadas



UNI/ISO 2725 DIN 3124

mm	Ø mm	L mm	Ø1 mm	€		
8	12,4	38	21,7	5,90	10	009200008
9	13,5	38	21,7	5,90	10	009200009
10	14,9	38	21,7	5,90	10	009200010
11	16,1	38	21,7	5,90	10	009200011
12	17,5	38	21,7	5,90	10	009200012
13	18,7	38	21,7	6,10	10	009200013
14	20,1	38	21,7	6,10	10	009200014
15	21,5	38	22,5	6,10	10	009200015
16	22,7	38	23,7	6,80	10	009200016
17	24,1	38	23,1	6,80	10	009200017
18	25,3	39	24,0	6,80	10	009200018
19	26,6	39	24,0	6,80	10	009200019
20	27,8	40	25,0	7,40	5	009200020
21	28,8	40	25,0	7,40	5	009200021
22	29,9	41	26,0	7,40	5	009200022
23	30,8	42	26,0	8,60	5	009200023
24	32,2	43	27,0	8,60	5	009200024
25	33,2	44	27,0	8,60	5	009200025
26	34,7	45	28,0	9,00	5	009200026
27	36,2	46	29,0	9,00	5	009200027
28	37,2	47	30,0	9,00	5	009200028
29	38,6	48	31,0	9,30	5	009200029
30	40,2	48	32,0	9,30	5	009200030
32	42,3	49	34,0	9,90	5	009200032



920A/SB13 € 103,00 1 009200040

10-11-12-13-14-15-16
17-18-19-20-21-22 mm



920A/SB8 € 84,00 1 009200042

23-24-25-26-27-28-30-32 mm



920MC

chaves de caixa sextavadas, coloridas

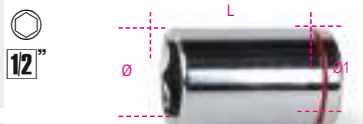

Ø mm	Ø mm	L mm	Ø1 mm		€		
8	13,2	38	22		6,40	5	009202008
10	15,3	38	22		6,40	5	009202010
11	16,5	38	22		6,40	5	009202011
12	17,8	38	22		6,40	5	009202012
13	19,0	38	22		6,70	5	009202013
14	20,3	38	22		6,70	5	009202014
15	21,6	38	22		6,70	5	009202015
16	23,0	38	23		7,40	5	009202016
17	23,9	38	24		7,40	5	009202017
18	25,0	38	25		7,40	5	009202018
19	26,5	38	24		7,40	5	009202019
21	28,8	38	27		8,10	3	009202021
22	29,9	40	28		8,10	3	009202022
24	32,8	40	30		9,40	3	009202024

920B

chaves de caixa, boca de 12 faces

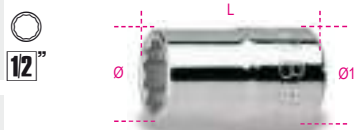

UNI/ISO 2725 DIN 3124

Ø mm	Ø mm	L mm	Ø1 mm		€		
8	12,4	38	21,7		5,90	10	009200108
9	13,5	38	21,7		5,90	10	009200109
10	14,9	38	21,7		5,90	10	009200110
11	16,1	38	21,7		5,90	10	009200111
12	17,5	38	21,7		5,90	10	009200112
13	18,7	38	21,7		6,10	10	009200113
14	20,1	38	21,7		6,10	10	009200114
15	21,5	38	22,5		6,10	10	009200115
16	22,7	38	23,7		6,80	10	009200116
17	24,1	38	23,1		6,80	10	009200117
18	25,3	39	24,0		6,80	10	009200118
19	26,6	39	24,0		6,80	10	009200119
20	27,8	40	25,0		7,40	5	009200120
21	28,8	40	25,0		7,40	5	009200121
22	29,9	41	26,0		7,40	5	009200122
23	30,8	42	26,0		8,60	5	009200123
24	32,2	43	27,0		8,60	5	009200124
25	33,2	44	27,0		8,60	5	009200125
26	34,7	45	28,0		9,00	5	009200126
27	36,2	46	29,0		9,00	5	009200127
28	37,2	47	30,0		9,00	5	009200128
29	38,6	48	31,0		9,30	5	009200129
30	40,2	48	32,0		9,30	5	009200130
32	42,3	49	33,9		9,90	5	009200132



920B/SB13 103,00 1 009200140
10-11-12-13-14-15-16
17-18-19-20-21-22 mm



920B/SB8 84,00 1 009200142
23-24-25-26-27
28-30-32 mm

920AL

chaves de caixa série longa,
boca hexagonal



UNI/ISO 2725 DIN 3124

Ø mm	Ø mm	L mm	Ø1 mm		€		
10	14,7	77	21		19,30	5	009200626
12	17,8	77	21		19,30	5	009200627
13	19,0	77	22		19,30	5	009200628
14	20,3	77	22		19,30	5	009200629
15	21,5	77	22		19,30	5	009200630
16	22,8	77	22		20,80	5	009200631
17	24,0	77	23		20,80	5	009200632
18	25,0	77	24		21,80	5	009200633
19	26,5	77	25		21,80	5	009200634
21	29,0	77	27		24,20	5	009200635
22	30,0	77	28		24,20	5	009200636
23	31,5	77	29		24,20	5	009200637
24	32,8	77	30		28,00	5	009200638
27	36,5	77	33		29,00	3	009200639
30	40,0	77	36		35,00	3	009200640
32	42,8	77	38		35,50	3	009200641
36	48,0	77	41		57,50	3	009200642



920AL/SB11 249,00 1 009200644
10-12-13-14-15-16
17-18-19-21-22 mm

920BL

chaves de caixa série longa,
boca de 12 faces



UNI/ISO 2725 DIN 3124

Ø mm	Ø mm	L mm	Ø1 mm		€		
10	14,7	77	21		19,30	5	009200310
12	17,8	77	21		19,30	5	009200312
13	19,0	77	22		19,30	5	009200313
14	20,3	77	22		19,30	5	009200314
15	21,5	77	22		19,30	5	009200315
16	22,8	77	22		20,80	5	009200316
17	24,0	77	23		20,80	5	009200317
18	25,0	77	24		21,80	5	009200318
19	26,5	77	25		21,80	5	009200319
21	29,0	77	27		24,20	5	009200321
22	30,0	77	28		24,20	5	009200322
23	31,5	77	29		24,20	5	009200323
24	32,8	77	30		28,00	5	009200324
27	36,5	77	33		29,00	3	009200327
30	40,0	77	36		35,00	3	009200330
32	42,8	77	38		35,50	3	009200332
36	48,0	77	41		57,50	3	009200336



920BL/SB11 249,00 1 009200338
10-12-13-14-15-16-17-18
19-21-22 mm

920A/AS

chaves de caixa boca hexagonal

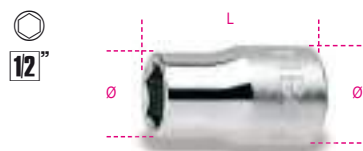

Ø mm	Ø mm	L mm	Ø1 mm		€		
3/8	14,6	37	21		6,90	2	009200270
7/16	16,5	37	21		6,90	3	009200272
1/2	19,0	37	22		7,10	3	009200273
9/16	20,3	37	22		7,10	3	009200274
19/32	21,0	37	22		7,70	3	009200275
5/8	22,8	37	22		7,70	3	009200276
11/16	25,0	37	24		7,90	3	009200277
3/4	26,5	38	25		7,90	3	009200279
25/32	28,0	38	26		8,80	3	009200280
13/16	29,0	38	27		8,80	3	009200281
7/8	30,0	40	28		8,80	3	009200282
15/16	32,8	42	30		9,40	3	009200284
1	35,0	42	32		9,40	3	009200285
1.1/16	36,5	43	33		10,30	2	009200287
1.1/8	39,0	43	35		10,70	2	009200289
1.3/16	41,0	46	36		11,50	2	009200290
1.1/4	42,8	46	38		11,70	2	009200292



920A-AS/SB11 104,00 1 009200295
3/8-7/16-1/2-9/16-5/8
11/16-3/4-13/16-7/8
15/16-1

920AS

chaves de caixa, boca de 12 faces



Ø mm	Ø mm	L mm	Ø1 mm		€		
3/8	14,9	38	21,7		6,90	3	009200201
7/16	16,1	38	21,7		6,90	3	009200202
1/2	18,7	38	21,7		7,10	3	009200203
9/16	20,1	38	21,7		7,10	3	009200204
5/8	22,7	38	22,5		7,70	3	009200206
19/32	21,5	38	23,7		7,70	3	009200207
11/16	25,3	39	24,0		7,90	3	009200208
3/4	26,6	39	24,0		7,90	3	009200209
25/32	27,8	40	25,0		8,80	3	009200210
13/16	28,8	40	25,0		8,80	3	009200211
7/8	29,9	41	26,0		8,80	3	009200212
15/16	32,2	43	27,0		9,40	3	009200214
1	34,2	45	28,0		9,40	3	009200216
1.1/16	36,2	46	29,0		10,30	2	009200217
1.1/8	38,6	48	31,0		10,70	2	009200218
1.3/16	40,2	48	32,0		11,50	2	009200219
1.1/4	42,3	49	33,5		11,70	2	009200220



920AS/SB11 104,00 1 009200225
3/8-7/16-1/2-9/16-5/8
11/16-3/4-13/16-7/8
15/16-1

920AS/L

chaves de caixa série longa boca hexagonal



"	Ø mm	L mm	Ø1 mm	€	🔧	📦
1/2	19,0	77	22	26,50	2	009200352
9/16	20,3	77	22	26,50	2	009200353
5/8	22,8	77	22	26,50	2	009200355
11/16	25,0	77	24	28,50	2	009200357
3/4	26,5	77	25	29,00	2	009200358
13/16	29,0	77	27	34,50	2	009200360
7/8	30,0	77	28	34,50	2	009200361
15/16	32,8	77	30	35,50	2	009200362
1	35,0	77	32	36,50	2	009200363
1.1/16	36,5	77	33,0	40,00	2	009200364
1.1/8	37,8	77	34	41,00	2	009200365



920ASL/SB11 € 378,00 1 009200369
1/2-9/16-5/8-11/16
3/4-13/16-7/8-15/16
1-1.1/8-1.1/16

920U

chaves de caixa para bloqueio de embraiagem



mm	"	🔧	📦	L mm	€	🔧	📦
10	3/8	E12	M12	38	6,20	5	009201710
11	7/16	E14	M14	38	6,20	5	009201711
12	15/32	E16		38	6,20	5	009201712
13	1/2		M16	38	6,50	5	009201713
14	9/16	E18	M18	38	6,50	5	009201714
15	19/32			38	6,50	5	009201715
16	5/8	E20		38	7,20	5	009201716
17				38	7,20	5	009201717
18		E22		38	7,20	5	009201718
19	3/4	E24		38	7,20	5	009201719
20	25/32			38	7,90	3	009201720
21				38	7,90	3	009201721
22	7/8			38	7,90	3	009201722
24	15/16			38	9,00	3	009201724
27	1.1/16			42	9,50	3	009201727
30	1.1/8			44	10,00	3	009201730
32	1.1/4			44	10,40	3	009201732



920U/SB13 € 108,00 1 009201740
10-11-12-13-14-15-16
17-18-19-20-21-22 mm



920U/SB4 € 46,50 1 009201744
24-27-30-32 mm

920FTX

chaves de caixa para parafusos de perfil Torx®

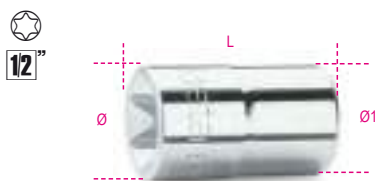

🔧	📦	Ø mm	L mm	Ø1 mm	€	🔧	📦
E10	5	13,2	36	21	11,70	5	009200380
E12	5	15,0	37	21	11,70	5	009200381
E14	5	16,3	37	21	11,70	5	009200382
E16	5	18,8	37	22	11,70	5	009200383
E18	5	20,4	37	22	11,70	5	009200384
E20	5	22,9	37	22	12,80	5	009200385
E22	3	25,0	37	24	14,80	3	009200387
E24	3	26,5	40	25	16,70	3	009200388



920FTX/SB6 € 83,00 1 009200390
E10-E12-E14
E16-E18-E20



920FTX/C8 € 141,00 1 009200391
E10-E12-E14-E16
E18-E20-E22-E24

📏 270X120X45 mm - 📖 1 kg

920FTX/L

chaves de caixa série longa para parafusos de perfil Torx®



🔧	📦	Ø mm	L mm	Ø1 mm	€	🔧	📦
E10	5	13,2	77	21,0	24,60	5	009200400
E12	5	15,0	77	21,0	24,60	5	009200401
E14	5	16,3	77	21,0	24,60	5	009200402
E16	3	18,8	77	21,8	24,60	3	009200403
E18	3	20,4	77	21,8	24,60	3	009200404
E20	3	22,9	77	22,0	24,60	3	009200405



920FTX-LSB6 € 160,00 1 009200409
E10-E12-E14
E16-E18-E20

920LP

chaves de caixa com ponta de perfil de fenda



🔧	📦	SxA mm	Ø mm	L mm	L1 mm	€	🔧	📦
1x5,5	3	5,5	22,5	62	24	19,10	3	009200452
1,2x6,5	3	6,5	22,5	62	24	19,10	3	009200453
1,2x8	3	8,0	22,5	62	24	19,10	3	009200454
1,6x9	3	9,0	22,5	62	24	19,10	3	009200456
2x12	3	12,0	22,5	62	24	19,10	3	009200458

920PH

chaves de caixa com ponta de perfil Phillips®



🔧	📦	PH	Ø mm	L mm	L1 mm	€	🔧	📦
1	3	1	22,5	56	18	16,80	3	009200471
2	3	2	22,5	56	18	16,80	3	009200472
3	3	3	22,5	56	18	16,80	3	009200473
4	3	4	22,5	56	18	16,80	3	009200474



920PH/SB4 € 76,50 1 009200479
PH1-PH2-PH3-PH4

920LH/SB7

chaves de caixa com ponta de perfil Phillips®



🔧	📦	920LH/SB7	€	🔧	📦
920LP	1	1,2x6,5 - 1,2x8	140,00	1	009200478
920PH	1	1,6x9 - 2x12 mm PH2 - PH3 - PH4			

920PE

chaves de caixa com ponta macho hexagonal



DIN 7422

mm	Ø mm	L mm	L1 mm	€	U	PC
3	22,5	58	20	15,30	5	009200410
4	22,5	58	20	15,30	5	009200412
5	22,5	58	20	15,30	5	009200414
5L	22,5	100	62	16,70	5	009200415
6	22,5	58	20	15,30	5	009200417
6L	22,5	100	62	16,70	5	009200418
7	22,5	58	20	15,30	5	009200420
7L	22,5	100	62	16,70	5	009200421
8	22,5	58	20	15,30	5	009200423
8L	22,5	100	62	16,70	5	009200424
9	22,5	58	20	15,30	5	009200425
9L	22,5	140	102	17,60	5	009200426
10	22,5	58	20	15,30	5	009200428
10L	22,5	140	102	17,60	5	009200429
12	23,0	58	20	17,80	5	009200432
12L	22,5	140	102	20,30	5	009200433
14	22,5	58	20	17,80	5	009200434
14L	22,5	140	102	20,30	5	009200435
17	29,5	60	22	21,70	5	009200437
19	29,5	60	22	21,70	5	009200439



920PE/SB9 € 160,00 U 1 009200441
4-5-6-8-10 mm
5L-6L-8L-10L mm



920PE/C10 € 209,00 U 1 009200443
4-5-6-7-8-10
12-14-17-19 mm

270X120X45 mm - 1,5 kg

9899 920PE/C10 € 15,20 U 1 098990135
Tabuleiro maleável, vazio

920PE/AS

chaves de caixa com ponta macho hexagonal

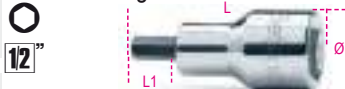

"	Ø mm	L mm	L1 mm	€	U	PC
1/8	22,5	58	20	17,90	2	009200460
3/16	22,5	58	20	17,90	2	009200461
1/4	22,5	58	20	17,90	2	009200463
3/8	22,5	58	20	17,90	2	009200464
1/2	22,5	60	20	19,60	2	009200465
3/4	22,5	60	20	21,00	1	009200468



920PE-AS/SB6 € 124,00 U 1 009200469
1/8-3/16-1/4-3/8-1/2-3/4

920BP

chaves de caixa com ponta macho hexagonal esférico

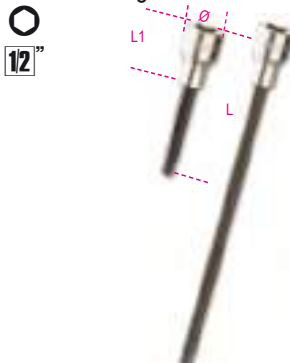

mm	Ø mm	L mm	L1 mm	€	U	PC
5L	22,5	100	62	19,20	5	009200490
5XL	22,5	240	202	24,70	1	009200495
6L	22,5	100	62	19,20	5	009200491
6XL	22,5	240	202	24,70	1	009200496
7L	22,5	100	62	19,20	5	009200492
8L	22,5	100	62	19,20	5	009200493
8XL	22,5	240	202	24,70	1	009200497
10L	22,5	140	102	21,00	5	009200494



920BP/SB8 € 187,00 U 1 009200500
5L-6L-7L-8L-10L mm
5XL-6XL-8XL mm

920ME

chaves de caixa com ponta macho hexagonal

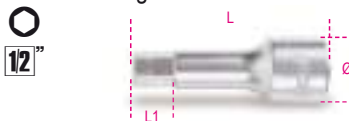

mm	Ø mm	L mm	L1 mm	€	U	PC
5	21	75	15,5	17,90	5	009200505
6	21	75	15,5	17,90	5	009200506
7	21	75	15,5	17,90	5	009200507
8	21	75	15,5	17,90	5	009200508
10	23	75	15,5	18,70	5	009200510
12	24	75	15,5	21,50	5	009200512
14	24	75	15,5	22,20	5	009200514
17	24	75	15,5	22,20	5	009200517



920ME/SB7 € 151,00 U 1 009200519
5-6-8-10-12-14-17 mm



920ME/C7 € 171,00 U 1 009200518
5-6-8-10-12-14-17 mm
250X100X35 mm - 1,4 kg

920TX

chaves de caixa com ponta macho de perfil Torx®

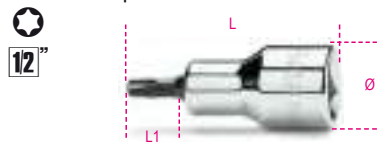

mm	Ø mm	L mm	L1 mm	€	U	PC
T20	22,5	58	20	18,70	5	009200520
T20L	22,5	120	82	23,90	3	009200530
T25	22,5	58	20	18,70	5	009200521
T25L	22,5	120	82	23,90	3	009200531
T27	22,5	58	20	18,70	5	009200522
T27L	22,5	120	82	23,90	3	009200533
T30	22,5	58	20	18,70	5	009200523
T30L	22,5	120	82	23,90	3	009200534
T40	22,5	58	20	18,70	5	009200524
T40L	22,5	120	82	23,90	3	009200535
T45	22,5	58	20	18,70	5	009200525
T45L	22,5	120	82	23,90	3	009200537
T50	22,5	58	20	18,70	5	009200526
T50L	23,0	140	102	23,90	3	009200538
T55	23,0	58	20	25,00	3	009200527
T55L	23,0	140	102	34,00	3	009200539
T60	23,0	58	20	25,00	3	009200528
T60L	23,0	140	102	34,00	3	009200540
T70L	23,0	120	82	34,00	3	009200541



920TX/SB9 € 197,00 U 1 009200532
T20-T25-T27-T30
T40-T45-T50-T55-T60

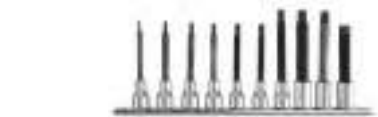

920TX-L/SB10 € 286,00 U 1 009200545
T20L-T25L-T27L-T30L-T40L-
T45L-T50L-T55L-T60L-T70L



920TX/C9 € 218,00 U 1 009200546
T20-T25-T27-T30-T40
T45-T50-T55-T60
270X120X45 mm - 1,2 kg

9899 920TX/C9 € 15,20 U 1 098990136
Tabuleiro maleável, vazio

920RTX

chaves de caixa com ponta macho de perfil Tamper Resistant Torx®



Ø mm	L mm	L1 mm	€	U	U
T20	22,5	58	20,00	5	009200370
T25	22,5	58	20,00	5	009200371
T27	22,5	58	20,00	5	009200372
T30	22,5	58	20,00	5	009200373
T40	22,5	58	20,00	5	009200374



920RTX/SB5
T20-T25-T27-T30-T40
€ 111,00 U 1 009200378

920XZN

chaves de caixa com ponta macho de perfil XZN(R)

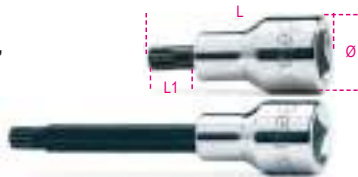

DIN 2324

Ø mm	L mm	L1 mm	€	U	U
M4	22,5	58	20,10	3	009200559
M5	22,5	58	20,10	3	009200560
M6	22,5	58	20,10	3	009200561
M6L	22,5	100	22,90	3	009200562
M8	22,5	58	20,10	3	009200563
M8L	22,5	100	22,90	3	009200564
M9	22,5	58	20,10	3	009200582
M9L	22,5	100	22,90	3	009200583
M10	22,5	58	20,30	3	009200565
M10L	22,5	100	22,90	3	009200566
M12	22,5	58	21,00	3	009200568
M12L	22,5	100	23,50	3	009200569
M14	23,0	58	21,00	3	009200571
M14L	23,0	100	23,50	3	009200572
M16	23,0	58	26,00	3	009200573
M18	23,0	58	26,50	3	009200574



920XZN/SB7
M4-M5-M6-M8
M10-M12-M14
€ 156,00 U 1 009200579



920XZN/SB12
M5-M6-M8-M10-M12
M14-M16-M6L-M8L
M10L-M12L-M14L
€ 285,00 U 1 009200577



920XZN-L/S5
M6L-M8L-M10L
M12L-M14L
€ 116,00 U 1 009200578

920ES

chaves de caixa com pontas de 6 caneluras

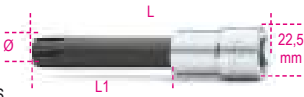

UNI 9326

Ø mm	L mm	L1 mm	€	U	U
7	(6R)	58	28,00	5	009200587
7XL	(6R)	240	39,50	1	009200607
9	(8R)	58	28,00	5	009200589
9XL	(8R)	240	39,50	1	009200609
10	(8S)	58	28,00	5	009200590
10XL	(8S)	240	39,50	1	009200610
11	(10R)	58	28,00	5	009200591
11XL	(10R)	240	39,50	1	009200611
12L	(10S)	100	31,50	3	009200592
12XL	(10S)	240	43,00	1	009200612
14L	(12S)	100	31,50	3	009200594
14XL	(12S)	240	43,00	1	009200614
16L	(14R)	100	31,50	3	009200596
16XL	(14R)	240	43,00	1	009200616



920ES/SB7
7-9-10-11-12L-14L-16L
€ 220,00 U 1 009200598



920ES-XL/SB7
7XL-9XL-10XL-11XL
12XL-14XL-16XL
€ 300,00 U 1 009200618

PM 1/2-Q5



PM 1/2-Q5 € 72,560

920/15

redução quadra fêmea de 1/2" para quadra macho de 3/8"



UNI/ISO 3316 DIN 3123

L mm	Ø mm	€	U	U
42	22,0	12,00	5	009200810



Aplique sempre uma força de aperto regular e progressiva, a fim de evitar a ruptura do material e de se proteger de um possível acidente

920/16

adaptador quadra fêmea de 1/2" para quadra macho de 3/4"



UNI/ISO 3316 DIN 3123

L mm	Ø mm	€	U	U
46	26	15,70	5	009200814

920/20÷920/23

extensões com quadras macho e fêmea de 1/2"



UNI/ISO 3316 DIN 3123

L mm	Ø mm	€	U	U
920/20	22	14,70	5	009200818
920/21	22	17,90	5	009200822
920/22	22	20,30	5	009200826
920/23	22	27,00	2	009200827

920AN

extensões com quadras macho angulares e fêmea de 1/2"

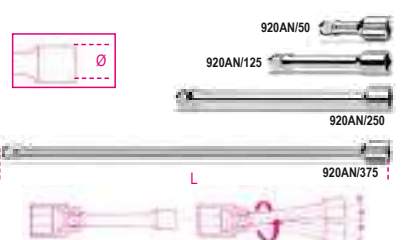

L mm	Ø mm	€	U	U
920AN/50	22	15,70	5	009200833
920AN/125	22	21,60	5	009200834
920AN/250	22	30,50	3	009200835
920AN/375	22	40,50	3	009200836

920/25

cardan com quadras macho e fêmea de 1/2"



UNI/ISO 3316 DIN 3123

L mm	Ø mm	€			
75	27	28,50	5	009200830	

920/35A

cabos articulados com punho quadra de 1/2"

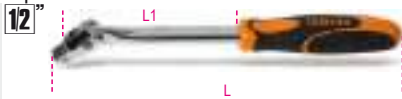

UNI/ISO 3315 DIN 3122

L mm	L1 mm	€			
285	160	57,00	3	009200846	

920M/35

cabo articulado com punho metálico quadra de 1/2"



UNI/ISO 3315 DIN 3122

L mm	€				
380	81,50	2	009200845		

920M/35L

punho articulado quadra macho 1/2" com cabo metálico, série longa



L mm	€				
600	123,00	1	009200843		



Aplique sempre uma força de aperto regular e progressiva, a fim de evitar a ruptura do material e de se proteger de um possível acidente

920/36A

cabo articulado com punho quadra de 1/2"



UNI/ISO 3315 DIN 3122

L mm	L1 mm	€			
408	283	64,00	2	009200847	

920/38

cabo articulado extensível com punho, quadra 1/2"



L mm	L max mm	€			
262	402	96,50	1	009200839	

920/40

extensão articulada com punho em T quadra de 1/2"



L mm	L1 mm	€			
490	230	66,50	2	009200850	

920/42

cabo T corredeira, quadra de 1/2"

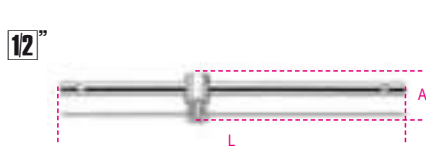

UNI/ISO 3315 DIN 3122

L mm	A mm	€			
305	42	20,10	5	009200854	

920/44

cabo angular quadra de 1/2"



UNI/ISO 3315 DIN 3122

L mm	L1 mm	€			
230	60	29,50	3	009200858	

920/46

manivela quadra macho de 1/2"

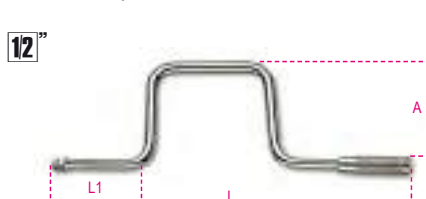

UNI/ISO 3315 DIN 3122

L mm	L1 mm	A mm	€		
385	110	160	36,50	1	009200862

920/50

roquete simples quadra de 1/2" 72 dentes

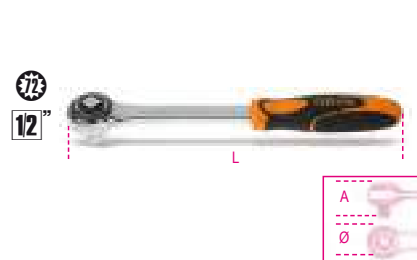

UNI/ISO 3315 DIN 3122

L mm	Ø mm	A mm	€		
275	40	42	63,50	3	009200871

920/50F

roquete simples quadra fêmea de 1/2" 72 dentes

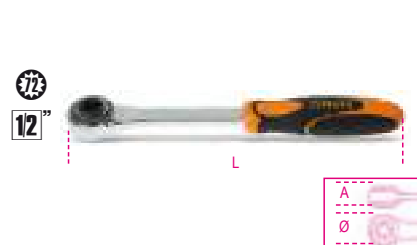

UNI/ISO 3315 DIN 3122

L mm	Ø mm	A mm	€		
275	40	27	58,50	2	009200889

920/55

roquete reversível com quadra de 1/2" 72 dentes



UNI/ISO 3315 DIN 3122

L mm	Ø mm	A mm	€		
275	40	43	68,00	3	009200882

920/55Q

roquete reversível com quadra de 1/2" 48 dentes



UNI/ISO 3315 DIN 3122

L mm	Ø mm	A mm	€		
275	40	43	68,00	3	009200885

920/55X

roquete reversível com quadra de 1/2"
72 dentes



UNI/ISO 3315 DIN 3122

L	Ø	A	€		
mm	mm	mm			
200	30	33	58,00	3	009200895

920/55LC

roquete reversível com quadra de 1/2"
"Locking System" de 72 dentes



UNI/ISO 3315 DIN 3122

L	Ø	A	€		
mm	mm	mm			
275	40	43	78,50	2	009200896

920M/55

roquete reversível com punho metálico
quadra de 1/2"

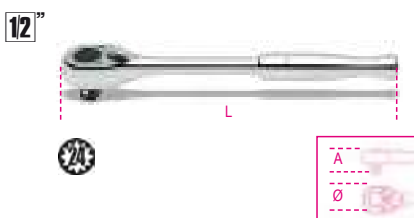

L	Ø	A	€		
mm	mm	mm			
253	38	35	87,50	1	009200893

920/56A

roquete reversível articulado
quadra de 1/2" de 72 dentes



L	Ø	A	€		
mm	mm	mm			
315	40	43	112,00	1	009200911

920M/56

roquete reversível articulado
com punho metálico, quadra de 1/2"



L	Ø	A	€		
mm	mm	mm			
330	38	35,7	117,00	2	009200894

920/58

roquete reversível quadra 1/2"
com punho rotativo,
52 dentes

- Funcionamento através de punho rotativo
- Botão de desbloqueio da chave de caixa
- Sistema de inversão através de porca na cabeça do roquete
- Punho bi-material

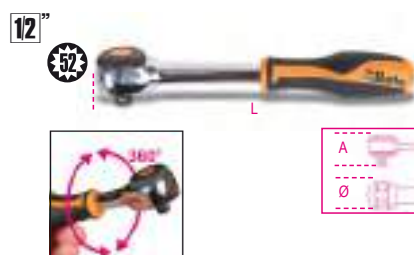

L	Ø	A	€		
mm	mm	mm			
281	42,5	45	102,00	1	009200926

Ver quadro depois do artigo 929/C8
para acessórios compatíveis usados

920.../C11

jogo com 11 chaves de caixa
e 2 acessórios



920A/C11	€		
	215,00	1	009200921

920A	10 - 12 - 13 - 14 - 15 - 16 17 - 18 - 19 - 21 - 22 mm
920/22	255 mm
920/50	
≡ 335x145x60 mm - 2,5 kg	

920B/C11	€		
	215,00	1	009200922

920B	10 - 12 - 13 - 14 - 15 - 16 17 - 18 - 19 - 21 - 22 mm
920/22	255 mm
920/50	
≡ 335x145x60 mm - 2,5 kg	

920.../C12...

jogo com 12 chaves de caixa
e 5 acessórios



920A/C12X	€		
	313,00	1	009200933

920A	10 - 11 - 12 - 13 - 14 - 17 - 19 22 - 24 - 27 - 30 - 32 mm
920/21	125 mm
920/22	255 mm
920/25	
920/42	
920/55	
≡ 420x185x60 mm - 4,2 kg	

9899 920C12	€		
Tabuleiro maleável, vazio	15,20	1	098990116

920A/C12	€		
	309,00	1	009200931

920A	10 - 11 - 12 - 13 - 14 - 17 - 19 22 - 24 - 27 - 30 - 32 mm
920/21	125 mm
920/22	255 mm
920/25	
920/42	
920/50	
≡ 420x185x60 mm - 4,2 kg	



9899 920C12 15,20 € 1 098990116
 Tabuleiro maleável, vazio

920B/C12X 313,00 € 1 009200934

- 920B 10 - 11 - 12 - 13 - 14 - 17 - 19
22 - 24 - 27 - 30 - 32 mm
- 920/21 125 mm
- 920/22 255 mm
- 920/25
- 920/42
- 920/55

420x185x60 mm - 4,0 kg

9899 920C12 15,20 € 1 098990116
 Tabuleiro maleável, vazio

920B/C12 309,00 € 1 009200932

- 920B 10 - 11 - 12 - 13 - 14 - 17 - 19
22 - 24 - 27 - 30 - 32 mm
- 920/21 125 mm
- 920/22 255 mm
- 920/25
- 920/42
- 920/50

420x185x60 mm - 4,0 kg

9899 920C12 15,20 € 1 098990116
 Tabuleiro maleável, vazio

920MC/C14

14 chaves de caixa sextavadas coloridas e 5 acessórios

12"



920MC/C14 272,00 € 1 009202964

- 920MC 8 - 10 - 11 - 12 - 13 - 14 - 15 - 16 - 17
18 - 19 - 21 - 22 - 24 mm
- 920/21 125 mm
- 920/22 255 mm
- 920/25
- 920/42
- 920/55

420x185x60 mm - 4,2 kg

920.../C20...

jogo com 20 chaves de caixa e 5 acessórios

12"



920A/C20X 387,00 € 1 009200950

- 920A 10 - 11 - 12 - 13 - 14 - 15 - 16
17 - 18 - 19 - 20 - 21 - 22 - 23
24 - 26 - 27 - 28 - 30 - 32 mm
- 920/21 125 mm
- 920/22 255 mm
- 920/25
- 920/42
- 920/55

420x185x60 mm - 5,1 kg

9899 920C20 15,20 € 1 098990121
 Tabuleiro maleável, vazio

920A/C20 383,00 € 1 009200948

- 920A 10 - 11 - 12 - 13 - 14 - 15 - 16
17 - 18 - 19 - 20 - 21 - 22 - 23
24 - 26 - 27 - 28 - 30 - 32 mm
- 920/21 125 mm
- 920/22 255 mm
- 920/25
- 920/42
- 920/50

420x185x60 mm - 5,1 kg

9899 920C20 15,20 € 1 098990121
 Tabuleiro maleável, vazio

920A/C20Q 387,00 € 1 009200955

- 920A 10 - 11 - 12 - 13 - 14 - 15 - 16
17 - 18 - 19 - 20 - 21 - 22 - 23
24 - 26 - 27 - 28 - 30 - 32 mm
- 920/21 125 mm
- 920/22 255 mm
- 920/25
- 920/42
- 920/55Q

420x185x60 mm - 5,1 kg

9899 920C20 15,20 € 1 098990121
 Tabuleiro maleável, vazio

920B/C20 383,00 € 1 009200949

- 920B 10 - 11 - 12 - 13 - 14 - 15 - 16
17 - 18 - 19 - 20 - 21 - 22 - 23
24 - 26 - 27 - 28 - 30 - 32 mm
- 920/21 125 mm
- 920/22 255 mm
- 920/25
- 920/42
- 920/50

420x185x60 mm - 5,0 kg

9899 920C20 15,20 € 1 098990121
 Tabuleiro maleável, vazio

920B/C20X 387,00 € 1 009200951

- 920B 10 - 11 - 12 - 13 - 14 - 15 - 16
17 - 18 - 19 - 20 - 21 - 22 - 23
24 - 26 - 27 - 28 - 30 - 32 mm
- 920/21 125 mm
- 920/22 255 mm
- 920/25
- 920/42
- 920/55

420x185x60 mm - 5,0 kg

9899 920C20 15,20 € 1 098990121
 Tabuleiro maleável, vazio

920.../C21...

jogo com 21 chaves de caixa e 6 acessórios

12"



920A/C21 445,00 € 1 009200952

- 920A 10 - 11 - 12 - 13 - 14 - 15 - 16
17 - 18 - 19 - 20 - 21 - 22 - 23
24 - 25 - 26 - 27 - 28 - 30 - 32 mm
- 920/21 125 mm
- 920/22 255 mm
- 920/25
- 920/42
- 920/46
- 920/50

420x280x60 mm - 6,5 kg

920A/C21X 450,00 € 1 009200983

- 920A 10 - 11 - 12 - 13 - 14 - 15 - 16
17 - 18 - 19 - 20 - 21 - 22 - 23
24 - 25 - 26 - 27 - 28 - 30 - 32 mm
- 920/21 125 mm
- 920/22 255 mm
- 920/25
- 920/42
- 920/46
- 920/55

420x280x60 mm - 6,4 kg

920B/C21 445,00 € 1 009200953

- 920B 10 - 11 - 12 - 13 - 14 - 15 - 16
17 - 18 - 19 - 20 - 21 - 22 - 23
24 - 25 - 26 - 27 - 28 - 30 - 32 mm
- 920/21 125 mm
- 920/22 255 mm
- 920/25
- 920/42
- 920/46
- 920/50

420x280x60 mm - 6,4 kg



920B/C21X € 450,00 1 009200984

- 920B 10 - 11 - 12 - 13 - 14 - 15 - 16
17 - 18 - 19 - 20 - 21 - 22 - 23
24 - 25 - 26 - 27 - 28 - 30 - 32 mm
- 920/21 125 mm
- 920/22 255 mm
- 920/25
- 920/42
- 920/46
- 920/55

420x280x60 mm - 6,4 kg

920B/C30Q

jogo com 30 chaves de caixa de 12 faces e 5 acessórios

12"



920B/C30Q € 635,00 1 009200975

- 920B 8 - 9 - 10 - 11 - 12 - 13 - 14
15 - 16 - 17 - 18 - 19 - 20 - 21
22 - 23 - 24 - 26 - 27 - 30 mm
- 920BL 12 - 13 - 14 - 17 - 19 - 21
22 - 24 - 27 - 30 mm
- 920/21 125 mm
- 920/22 255 mm
- 920/25
- 920/42
- 920/55Q

420x280x60 mm - 7,6 kg



920.../C33

jogo com 20 chaves de caixa, 13 pontas e 5 acessórios

12"



920A/C33 € 625,00 1 009200985

- 920A 10 - 11 - 12 - 13 - 14 - 15 - 16
17 - 18 - 19 - 20 - 21 - 22 - 23
24 - 26 - 27 - 28 - 30 - 32 mm
- 920LP 1,2x8 - 1,6x9 - 2x12 mm
- ⊕ 920PH PH2 - PH3 - PH4
- 920PE 4 - 5 - 6 - 8 - 10 - 12 - 14 mm
- 920/21 125 mm
- 920/22 255 mm
- 920/25
- 920/42
- 920/55

420x280x60 mm - 6,7 kg

920B/C33 € 625,00 1 009200986

- 920B 10 - 11 - 12 - 13 - 14 - 15 - 16
17 - 18 - 19 - 20 - 21 - 22 - 23
24 - 26 - 27 - 28 - 30 - 32 mm
- 920LP 1,2x8 - 1,6x9 - 2x12 mm
- ⊕ 920PH PH2 - PH3 - PH4
- 920PE 4 - 5 - 6 - 8 - 10 - 12 - 14 mm
- 920/21 125 mm
- 920/22 255 mm
- 920/25
- 920/42
- 920/55

420x280x60 mm - 6,7 kg

920A/C17M - 920A/C17MR

Jogo de 17 chaves de caixa hexagonal e 5 acessórios em módulo flexível em caixa metálica

12"



920A/C17M € 356,00 1 009200924

- 920A 10-11-12-13-14-15-16-17-18
19-20-21-22-24-27-30-32 mm
- 920/21 125 mm
- 920/22 255 mm
- 920/25
- 920/42 305 mm
- 920/55

420x185x60 mm - 5 kg

9899 920C17 € 28,00 1 098990137

920A/C17MR € 390,00 1 009200937

- 920/21 125 mm
- 920/22 255 mm
- 920/25
- 920/42 305 mm
- 920/58

420x185x60 mm 5,1 kg

920/C37

jogo com 37 chaves de caixa de 12 faces e 2 acessórios

12"



920/C37 € 585,00 1 009200988

- 920B 10 - 11 - 12 - 13 - 14 - 15 - 16
17 - 18 - 19 - 20 - 21 - 22 - 23
24 - 26 - 27 - 28 - 30 - 32 mm
- 920AS 3/8 - 7/16 - 1/2 - 9/16 - 19/32
5/8 - 11/16 - 3/4 - 25/32 - 13/16
7/8 - 15/16 - 1 - 1.1/16 - 1.1/8
1.3/16 - 1.1/4
- 920/21 125 mm
- 920/22 255 mm
- 920/25
- 920/42
- 920/55

420x280x60 mm - 7,5 kg



920AS/C10

jogo com 10 chaves de caixa de 12 faces e 2 acessórios

12"



920AS/C10 € 222,00 1 009200919

- 920AS 3/8 - 7/16 - 1/2 - 9/16 - 5/8
11/16 - 3/4 - 13/16 - 7/8 - 15/16
- 920/22 255 mm
- 920/50
- 335x145x60 mm - 2,6 kg

920AS/C15

jogo com 15 chaves de caixa de 12 faces e 6 acessórios

12"



920AS/C15 € 415,00 1 009200947

- 920AS 3/8 - 7/16 - 1/2 - 9/16 - 5/8 - 11/16
3/4 - 13/16 - 7/8 - 15/16 - 1
1.1/16 - 1.1/8 - 1.3/16 - 1.1/4
- 920/21 125 mm
- 920/22 255 mm
- 920/25
- 920/42
- 920/46
- 920/50
- 420x280x60 mm - 5,9 kg

Beta

920AS/C17X

jogo com 17 chaves de caixa de 12 faces e 5 acessórios

12"



920AS/C17X € 386,00 1 009200942

- 920AS 3/8 - 7/16 - 1/2 - 9/16 - 19/32 - 5/8
11/16 - 3/4 - 25/32 - 13/16 - 7/8
15/16 - 1 - 1.1/16 - 1.1/8 - 1.3/16 - 1.1/4
- 920/21 125 mm
- 920/22 255 mm
- 920/25
- 920/42
- 920/55
- 420x185x60 mm - 4,8 kg

920AS/MBM-C21

jogo com 16 chaves de caixa de 12 faces e 5 acessórios

12"



920AS/MBM-C21 € 394,00 1 009200944

- 920AS 3/8 - 7/16 - 1/2 - 9/16
19/32 - 5/8 - 11/16 - 3/4
25/32 - 13/16 - 7/8 - 15/16
1 - 1.1/16 - 1.3/16 - 1.1/4
- 920M/55
- 920/21 125 mm
- 920/22 255 mm
- 920/25
- 920/42
- 420x185x60 mm - 5,0 kg

920TX/C17

jogo com 6 pontas, 6 chaves de caixa, 5 chaves de caixa com ponta e 4 acessórios, para parafusos de perfil Torx®



12"



920TX/C17 € 363,00 1 009200989

- 861TX T8 - T10 - T15 - T20 - T25 - T27
- 897
- 920TX T27 - T30 - T40 - T45 - T50
- 920FTX E10 - E12 - E14 - E16 - E18 - E20
- 920/20 75 mm
- 920/22 255 mm
- 920/55
- 420x185x60 mm - 2,9 kg

920A/C17HR

17 chaves de caixa sextavadas e 5 acessórios em estojo metálico com tabuleiro rígido

• roquete com punho rotativo

12"



920A/C17HR € 399,00 1 009200939

- 920A 10-11-12-13-14-15-16-17-18
19-20-21-22-24-27-30-32 mm
- 920/21 125 mm
- 920/22 255 mm
- 920/25
- 920/42
- 920/58
- 420x185x60 mm - 5,1 kg

Beta

920U/C17M

jogo 17 chaves de caixa para bloqueio/
desbloqueio de caixa de velocidades
e 5 acessórios,
em módulo soft

12"



920U/C17M € 300,00 1 009201797

920U ○ 10-11-12-13-14-15-16-17-18-19-20
21-22-24-27-30-32 mm
" 3/8-7/16-15/32-1/2-9/16-19/32-5/8-3/4
25/32-7/8-15/16-1.1/16-1.1/8-1.1/4
○ M12-M14-M16-M18
◎ E12-E14-E16-E18-E20-E22-E24

920/21 125 mm
920/22 255 mm
920/25
920/42 305 mm
920/55 275 mm

420x185x60 mm - 5 kg

9899 920C17 € 28,00 1 098990137

928A

chaves de caixa com boca hexagonal

3/4"



UNI/ISO 2725
DIN 3124

Ø mm	Ø mm	L mm	Ø1 mm	€		
19	29,2	50	34	18,30	5	009280019
21	30,0	51	34	18,60	5	009280021
22	31,3	53	34	18,60	5	009280022
23	33,3	53	34	18,90	5	009280023
24	34,5	53	34	19,20	5	009280024
26	36,8	55	35	20,50	5	009280026
27	38,0	56	35	20,50	5	009280027
28	39,0	57	35	21,80	3	009280028
29	40,2	58	35	22,30	3	009280029
30	41,5	58	37	22,80	3	009280030
32	44,3	60	37	23,70	3	009280032
33	45,8	60	37	24,90	3	009280033
34	46,8	60	37	25,50	3	009280034
35	48,1	62	38	26,00	3	009280035
36	49,5	64	38	26,00	3	009280036
38	52,0	68	40	28,50	3	009280038
41	56,0	71	40	31,50	3	009280041
46	62,3	75	43	38,50	3	009280046
50	67,4	80	43	47,00	3	009280050
55	73,7	84	48	58,00	1	009280055
60	80,0	87	48	66,50	1	009280060

928B

chaves de caixa boca de 12 faces

3/4"



UNI/ISO 2725
DIN 3124

Ø mm	Ø mm	L mm	Ø1 mm	€		
19	29,2	50	34	18,30	5	009280119
21	30,0	51	34	18,60	5	009280121
22	31,3	53	34	18,60	5	009280122
23	33,3	53	34	18,90	5	009280123
24	34,5	53	34	19,20	5	009280124
26	36,8	55	35	20,50	5	009280126
27	38,0	56	35	20,50	5	009280127
28	39,0	57	35	21,80	3	009280128
29	40,2	58	35	22,30	3	009280129
30	41,5	58	37	22,80	3	009280130
32	44,3	60	37	23,70	3	009280132
33	45,8	60	37	24,90	3	009280133
34	46,8	60	37	25,50	3	009280134
35	48,1	62	38	26,00	3	009280135
36	49,5	64	38	26,00	3	009280136
38	52,0	68	40	28,50	3	009280138
41	56,0	71	40	31,50	3	009280141
46	62,3	75	43	38,50	3	009280146
50	67,4	80	43	47,00	3	009280150
55	73,7	84	48	58,00	1	009280155
60	80,0	87	48	66,50	1	009280160

928AS

chaves de caixa boca hexagonal

3/4"



Ø mm	Ø mm	L mm	Ø1 mm	€		
7/8	32,0	53	34	21,00	1	009280202
15/16	34,5	53	34	21,00	1	009280203
1	36,2	55	35	22,20	1	009280204
1.1/16	38,0	56	35	22,90	1	009280205
1.1/8	40,2	58	35	23,50	1	009280206
1.1/4	44,2	60	37	25,50	1	009280208
1.5/16	45,8	60	37	26,50	1	009280209
1.3/8	48,1	62	38	28,00	1	009280210
1.7/16	49,5	64	38	29,00	1	009280211
1.1/2	52,0	68	40	31,50	1	009280212
1.5/8	56,0	71	40	34,50	1	009280214
1.11/16	58,8	74	40	39,50	1	009280215
1.13/16	62,3	75	43	44,00	1	009280217
1.7/8	65,0	78	43	47,50	1	009280218
2	68,3	80	43	54,50	1	009280219
2.1/16	71,5	83	48	63,50	1	009280220

928ME

chave de caixa com ponta macho hexagonal

3/4"

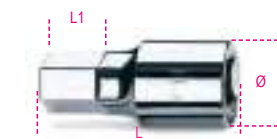

mm	Ø mm	L mm	L1 mm	€		
14	35	75	15,5	42,50	2	009280514
17	35	75	15,5	42,50	2	009280517
19	35	75	15,5	42,50	2	009280519
22	35	75	22,5	42,50	2	009280522

928/15

redução quadra fêmea de 3/4"
para quadra macho de 1/2"

3/4"



UNI/ISO 3316
DIN 3123

L mm Ø mm □ mm ■ mm € 5 009280801
51,5 34 3/4 1/2 22,20 5 009280801



Aplique sempre uma força de aperto regular e progressiva, a fim de evitar a ruptura do material e de se proteger de um possível acidente

928/16

adaptador quadra fêmea de 3/4"
para quadra macho de 1"

3/4"



UNI/ISO 3316
DIN 3123

L mm Ø mm □ mm ■ mm € 5 009280807
65 34 3/4 1" 26,50 5 009280807

928/20 - 928/21 - 928/22

extensões com quadras macho e fêmea de 3/4"

3/4"

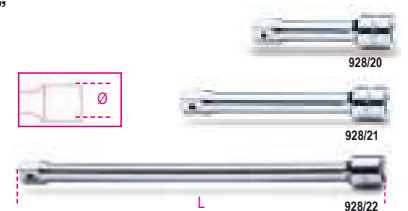

UNI/ISO 3316
DIN 3123

928/20	L mm	Ø mm	€		
928/20	100	34	26,00	3	009280810
928/21	200	34	35,00	3	009280815
928/22	380	34	51,50	3	009280825

928/25

cardan com quadras macho e fêmea 3/4"

3/4"



UNI/ISO 3316 DIN 3123

L mm Ø mm € 1 009280830
108 40 88,00 1 009280830

928/36A

cabo articulado, quadra de 3/4" com punho



DIN 3122 - UNI ISO 3315

L mm
545 € 106,00 1 009280844

928/42

cabo T corrediço, quadra de 3/4"

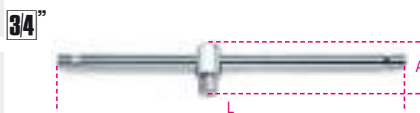

UNI/ISO 3315 DIN 3122

L mm A mm
450 62,5 € 56,00 3 009280850

928/55

roquete reversível com quadra de 3/4" 72 dentes

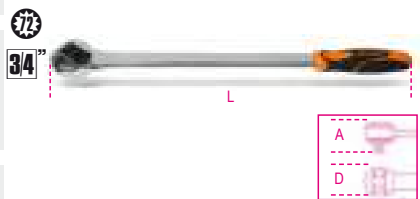

DIN 3122 - UNI ISO 3315

L mm Ø mm A mm
510 58 59 € 179,00 2 009280862

Ver quadro depois do artigo 929/C8 para acessórios compatíveis usados

928.../C12

jogo de 12 chaves de caixa hexagonal e 5 acessórios em caixa metálica



928A/C12 € 950,00 1 009280955

928A	22 - 24 - 27 - 30 - 32 - 34 - 36 38 - 41 - 46 - 50 - 55 mm
928/21	200 mm
928/22	380 mm
928/25	
928/42	
928/55	

530x220x80 mm - 13,5 kg

928B/C12 € 950,00 1 009280957

928B	22 - 24 - 27 - 30 - 32 - 34 - 36 38 - 41 - 46 - 50 - 55 mm
928/21	200 mm
928/22	380 mm
928/25	
928/42	
928/55	

530x220x80 mm - 13,5 kg

928AS/C12

jogo de 12 chaves de caixa hexagonal e 6 acessórios em caixa metálica



928AS/C12 € 980,00 1 009280968

928AS	7/8-15/16-1.1/16-1.1/8-1.1/4 1.5/16-1.7/16-1.1/2-1.11/16 1.13/16-1.7/8-2.1/16
928/21	200 mm
928/22	380 mm
928/25	
928/42	
928/55	

530x220x80 mm - 13,5 kg

929

chaves de caixa com boca hexagonal



UNI/ISO 2725 DIN 3124

mm	Ø mm	L mm	Ø1 mm	€	1	009290036
36	51	65	48	38,50	1	009290036
41	57	70	48	41,00	1	009290041
46	65	75	48	46,00	1	009290046
50	70	80	48	53,00	1	009290050
55	76	85	54	62,50	1	009290055
60	82	90	54	66,50	1	009290060
65	88	95	54	86,00	1	009290065
70	92	100	60	103,00	1	009290070
75	99	110	60	112,00	1	009290075
80	106	120	60	128,00	1	009290080

929/15

redução quadra fêmea de 1" para quadra macho de 3/4"



UNI/ISO 3316 DIN 3123

L mm Ø mm 1" 3/4 € 46,00 2 009290801



Aplique sempre uma força de aperto regular e progressiva, a fim de evitar a ruptura do material e de se proteger de um possível acidente

929/21 - 929/22

extensões com quadras macho e fêmea de 1"



UNI/ISO 3316 DIN 3123

L mm Ø mm € 1 009290815
929/21 200 47 59,00
929/22 400 47 86,00 1 009290825

929/42

cabo T corrediço, quadra de 1"



UNI/ISO 3315 DIN 3122

L mm € 111,00 1 009290850

929/55

roquete reversível, quadra de 1" 72 dentes



UNI/ISO 3315 DIN 3122

L mm Ø mm A mm € 238,00 1 009290860

929/55PR

extensão para roquete 929/55



L	Ø	Ø1	€	🔧	📄
mm	mm	mm			
540	32	26	51,00	1	009290868





929/C8

jogo com 8 chaves de caixa e 5 acessórios

1"



929/C8	€	🔧	📄
	1.390,00	1	009290925

	929	46 - 50 - 55 - 60 - 65 70 - 75 - 80 mm
	929/15	□ 1" - ■ 3/4
	929/21	200 mm
	929/22	400 mm
	929/42	
	929/55	

560x290x120 mm - 29 kg

9899 CV/A

estojo, vazio



9899 CV/A	€	🔧	📄
	37,50	1	098990001

583/C31-671B/C5-671B/C10-720ME/C8
860/C38P-861/C61P-900/C11-900AS/C10-/MB-C17
900/C24-900/C13-8-900/C13-5-900MB/C19-900MB/C28
900/C11HR-900AS/C10-/MB-C17-900AS/C17-MBM
900/C11Z-900MC/C24-900MC/C32-910.../C10
971/C8-920TX/C-920PE/C-920FTX/C-910.../C10

270x120x45 mm

9899 CV/B

estojo, vazio



9899 CV/B	€	🔧	📄
	43,50	1	098990002

352C/U-720MC/C13-727/C16-867/C20-900/C12MR
900/C12MZ-900U/C12M-910AS/C13...-910AS/MBM-C18
910A/C16...-910B/C16...-910A/C16HR
910A/C16...-910B/C16...-920AS/C10-920.../C11-1433/C11
1494/C14A-1529-1545/C5M

335x145x60 mm

9899 CV/C

estojo, vazio



9899 CV/C	€	🔧	📄
	53,50	1	098990003

920A/C17HR-920A/C17MR-920.../C12...
920A/C17M-910.../C29-902A/C22-867/C38
720/C24-450/C15-353N/C6-960KPC-920MC/C14
920U/C17M-920TX/C17-920.../C20...
920AS/MBM-C21-920AS/C17X-1547/C6-1495/C6
1489/C14-1461/C11A-1608/C9-1606A/C9-1602/C9

420x185x60 mm

900/R55

14"



900/R55	€	🔧	📄
	38,50	1	009000871

666N/2-900/55-666/2-666LBF.FT/2

900/R55-Z

14"



900/R55-Z	€	🔧	📄
	38,50	1	009000872

900M/R55

14"



900M/R55	€	🔧	📄
	20,30	1	009000888

900M/55

910/R55

38"



910/R55	€	🔧	📄
	37,50	1	009100879

599DGT/6-606/6-606/10-612-665/6-665/10-665LB/6
665LB/10-666N/5-666N/10-666N LBF.IN/5-666NLBF.IN/10
666/6-666/10-668RGC/6-668RGC/10-910/55-666/5
666HS/5-666HS/10-666 LBF.FT/5-666 LBF.FT/10

910M/R55

38"



910M/R55	€	🔧	📄
	21,00	1	009100888

910M/55-910M/56

910/R55Q

38"



910/R55Q	€	🔧	📄
	37,50	1	009100877

910/55Q

910/R55X

38"



910/R55X	€	🔧	📄
	37,50	1	009100879

666N/2X-666/2X-666 LBF.FT/2X

920/R50

12"



920/R50	€	🔧	📄
	37,00	1	009200866

614/50-667/20-667/30
667N/20-667N/30-920/50

920/R55

12"



920/R55	€	🔧	📄
	45,50	1	009200879

606/20-606/30-666/20-666/30-920/55
920/56A- 599DGT/20-599DGT/30
599DGT-AN/20-665/20-665/30-665LB/20
665LB/30-666N/20-666N/30
666N LBF.IN/20-666N LBF.IN/30-668RGC/20
666 LBF.FT/20-666 LBF.FT/30

920M/R55

12"



920M/R55	€	🔧	📄
	23,50	1	009200888

920M/55-920M/56

920/R55Q

12"



920/R55Q	€	🔧	📄
	45,50	1	009200877

920/55Q

920/R55X



920/R55X € 37,00 1 009200878
 606/10X-612X
 666/10X-920/55X-599DGT/10X-599DGT-AN/10
 665/10X-665LB/10X-666N10X-666N LBF.IN/10X
 668RGC/10X-666 LBF.FT/10X
 666HS/20LC-666HS/30LC

920/R55LC



920/R55LC € 47,50 1 009200887
 920/55LC "Locking System"
 666HS/20LC-666HS/30LC

928/R55



928/R55 € 75,50 1 009280859
 928/55

928/R55X



928/R55X € 48,00 1 009280858
 614X

929/R55



929/R55 € 87,00 1 009290859
 929/55

930

chaves tubulares de 12 faces,
serviço pesado



UNI 6745

mm	L mm	Ø mm	Ø1 mm	€	U	I
6x7	100	9,5	11,0	15,20	3	009300006
8x9	108	12,5	14,0	19,10	3	009300010
10x11	116	15,0	16,5	20,00	3	009300014
12x13	124	17,5	19,0	23,50	3	009300018
14x15	132	20,0	21,5	25,50	3	009300023
16x17	140	23,0	24,0	29,50	3	009300027

mm	L mm	Ø mm	Ø1 mm	€	U	I
18x19	148	25,0	26,5	32,50	3	009300032
20x22	156	28,0	30,0	36,00	2	009300036
21x23	163	29,0	31,5	38,00	2	009300040
24x26	173	33,0	35,5	48,50	2	009300044
25x28	182	34,5	38,0	52,50	2	009300048
27x29	191	37,0	39,5	60,00	2	009300052
30x32	200	40,5	43,0	72,50	2	009300056



930/S8 € 217,00 1 009300081
 6x7-8x9-10x11-12x13-14x15
 16x17-18x19-20x22 mm
940/1 - /2

930/S13 € 505,00 1 009300083
 6x7-8x9-10x11-12x13-14x15-16x17
 18x19-20x22-21x23-24x26
 25x28-27x29-30x32 mm
940/1 - /2 - /3



930/C13 € 580,00 1 009300098
 6x7-8x9-10x11-12x13
 14x15-16x17-18x19
 20x22-21x23-24x26
 25x28-27x29-30x32 mm
940/1 - /2 - /3

932

chaves de cachimbo 6 faces/12 faces
em cromado brilhante

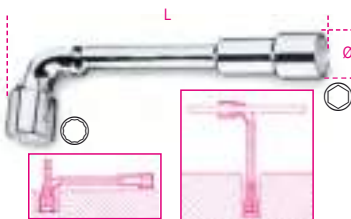

NF E 74.303

mm	Ø mm	L mm	€	U	I
6x6	11,5	110	17,10	5	009320006
7x7	12,5	116	17,30	5	009320007
8x8	13,0	120	17,90	5	009320008
9x9	14,0	125	18,60	5	009320009
10x10	16,5	133	19,30	5	009320010
11x11	17,5	143	21,10	5	009320011
12x12	19,0	148	22,40	5	009320012
13x13	19,5	154	23,40	5	009320013
14x14	21,5	167	24,70	5	009320014
15x15	22,5	182	26,00	5	009320015
16x16	24,5	193	27,00	5	009320016
17x17	26,0	198	27,50	5	009320017
18x18	26,5	215	30,00	5	009320018
19x19	29,0	220	32,50	5	009320019
20x20	30,5	222	35,00	3	009320020
21x21	30,5	236	40,00	3	009320021
22x22	32,5	250	43,50	2	009320022
23x23	33,5	256	48,50	2	009320023
24x24	35,0	272	52,00	2	009320024
25x25	36,5	282	55,50	2	009320025

mm	Ø mm	L mm	€	U	I
26x26	37,5	296	60,50	2	009320026
27x27	39,0	296	63,50	2	009320027
28x28	39,0	314	72,00	2	009320028
30x30	42,5	348	86,50	2	009320030
32x32	45,5	364	95,50	2	009320032



932/S11 € 267,00 1 009320080
 6-7-8-10-11-12
 13-14-17-19-22 mm

932/S17 € 443,00 1 009320081
 6-7-8-9-10-11-12 13-14-15
 16-17-18-19-20-21-22 mm

932/S25 € 975,00 1 009320082
 6-7-8-9-10-11-12-13-14-15-16-17-18-19
 20-21-22-23-24-25-26-27-28-30-32 mm

933

chaves de cachimbo hexagonal
em cromado brilhante

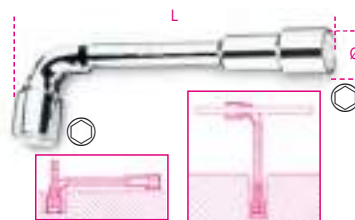

NF E 74.303

mm	Ø mm	L mm	€	U	I
6x6	11,5	110	17,10	5	009330006
7x7	12,5	116	17,30	5	009330007
8x8	13,0	120	17,90	5	009330008
9x9	14,0	125	18,60	5	009330009
10x10	16,5	133	19,30	5	009330010
11x11	17,5	143	21,10	5	009330011
12x12	19,0	148	22,40	5	009330012
13x13	19,5	154	23,40	5	009330013
14x14	21,5	167	24,70	5	009330014
15x15	22,5	182	26,00	5	009330015
16x16	24,5	193	27,00	5	009330016
17x17	26,0	198	27,50	5	009330017
18x18	26,5	215	30,00	5	009330018
19x19	29,0	220	32,50	5	009330019
20x20	30,5	222	35,00	3	009330020
21x21	30,5	236	40,00	3	009330021
22x22	32,5	250	43,50	2	009330022
23x23	33,5	256	48,50	2	009330023
24x24	35,0	272	52,00	2	009330024
25x25	36,5	282	55,50	2	009330025
26x26	37,5	296	60,50	2	009330026
27x27	39,0	296	63,50	2	009330027
28x28	39,0	314	72,00	2	009330028
30x30	42,5	348	86,50	2	009330030
32x32	45,5	364	95,50	2	009330032



933/S11 € 267,00 1 009330080
 6-7-8-10-11-12-13-14-17-19-22 mm

933/S17 € 443,00 1 009330081
 6-7-8-9-10-11-12-13-14-15-16-17
 18-19-20-21-22 mm

933/S25 € 975,00 1 009330082
 6-7-8-9-10-11-12-13-14-15-16-17-18-19
 20-21-22-23-24-25-26-27-28-30-32 mm

935

chaves tubulares hexagonais,
série ligeira



UNI 6746 DIN 896

Ø mm	L mm	€	🔧	📄
6x7	100	8,80	5	009350105
8x9	110	9,50	5	009350111
10x11	120	10,60	5	009350115
12x13	130	11,90	5	009350117
14x15	140	13,90	5	009350126
16x17	150	15,20	5	009350128
18x19	160	17,90	5	009350131
20x22	170	21,70	3	009350138
21x23	180	24,10	3	009350141
24x26	190	27,50	3	009350144
25x28	200	30,00	2	009350150
27x29	210	35,50	2	009350153
30x32	220	38,00	2	009350156



935/S8	125,00	1	009350181
6x7-8x9-10x11-12x13-14x15-16x17 18x19-20x22 mm			
940/1 - /2			
935/S13	295,00	1	009350183
6x7-8x9-10x11-12x13-14x15-16x17 18x19-20x22-21x23-24x26-25x28 27x29-30x32 mm			
940/1 - /2 - /3			

937

chaves de cachimbo 6 faces/12 faces
cromadas

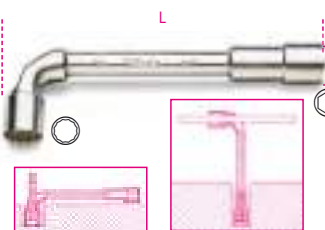

Ø mm	Ø mm	L mm	€	🔧	📄
6x6	11,5	110	9,50	5	009370006
7x7	12,5	116	9,90	5	009370007
8x8	13,0	120	10,20	5	009370008
9x9	14,0	125	10,90	5	009370009
10x10	16,5	133	11,40	5	009370010
11x11	17,5	143	11,90	5	009370011
12x12	19,0	148	13,30	5	009370012
13x13	19,5	154	13,70	5	009370013
14x14	21,5	167	15,00	5	009370014
15x15	22,5	182	16,50	5	009370015
16x16	24,5	193	17,80	5	009370016
17x17	26,0	198	18,50	5	009370017
18x18	26,5	215	18,90	5	009370018
19x19	29,0	220	19,70	5	009370019
20x20	30,5	222	22,30	3	009370020
21x21	30,5	236	24,40	3	009370021
22x22	32,5	250	25,50	2	009370022
23x23	33,5	256	28,50	2	009370023
24x24	35,0	272	29,50	2	009370024
25x25	36,5	282	37,50	2	009370025
26x26	37,5	296	38,50	2	009370026
27x27	39,0	296	39,50	2	009370027
28x28	39,0	314	47,50	2	009370028
30x30	42,5	348	51,00	2	009370030
32x32	45,5	364	57,50	2	009370032



937/S11	159,00	1	009370080
6-7-8-10-11-12-13-14-17-19-22 mm			
937/S17	269,00	1	009370081
6-7-8-9-10-11-12-13-14-15-16-17 18-19-20-21-22 mm			

940

passadores para chaves tubulares
refª. 930 e 935



Ø mm	L mm	€	🔧	📄	
940/1	6+13	100	6,60	5	009400001
940/2	14+22	170	8,60	5	009400002
940/3	21+32	290	15,50	5	009400003

941

chave de caixa sextavada/bisextavada,
com punho de binário elevado



Ø mm	L mm	L1 mm	A1 mm	€	🔧	📄
7x7	200	91	35	31,50	2	009410107
8x8	220	107	50	35,00	2	009410108
9x9	220	109	50	35,00	2	009410109
10x10	236	111	50	35,50	2	009410110
11x11	236	114	50	37,00	2	009410111
12x12	255	122	50	41,00	2	009410112
13x13	255	124	55	41,50	2	009410113



941/S7	257,00	1	009410170
7-8-9-10-11-12-13 mm			

CHAVES DE CAIXA COM PUNHO

Adequadas para operações de aperto rápidas e repetitivas. A sua espessura reduzida permite aceder a espaços reduzidos.

O furo de exaustão interior facilita o trabalho em porcas com roscas projetadas. É o caso das chaves de caixa profundas 944BX.

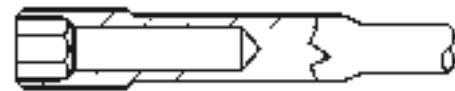

A marcação tripla na cabeça facilita a identificação do tamanho pretendido.

O veio flexível do modelo 943FL, com núcleo em aço e revestimento de proteção, permite a transmissão da força em caso de desalinhamento com o parafuso.

942BX

chave de caixa com punho sextavada de binário elevado modelo curto



UNI 6750

Ø mm	L mm	L1 mm	A1 mm	€	🔧	📄
4	190	70	13,0	15,90	5	009420003
5	190	70	14,0	15,90	5	009420004
5,5	190	70	12,5	17,90	5	009420005
6	190	70	14,5	17,90	5	009420006
7	190	70	15,5	18,80	5	009420007
8	202	70	18,5	18,80	5	009420008
9	202	70	19,5	18,80	5	009420009
10	202	70	20,5	20,00	3	009420010
11	202	70	21,5	20,00	3	009420011
12	202	70	22,5	20,00	3	009420012
13	202	70	23,5	22,60	3	009420013
14	202	70	24,5	22,60	3	009420014



942BX/S12	229,00	1	009420030
4-5-5,5-6-7-8-9 10-11-12-13-14 mm			

943BX

chave de caixa com punho sextavada de binário elevado modelo longo



ISO 2236 UNI 6750

Ø mm	L mm	L1 mm	A1 mm	€	U	U
4	270	150	13,0	17,60	5	009430003
5	270	150	14,0	17,60	5	009430004
5,5	270	150	12,5	18,90	5	009430005
6	270	150	14,5	18,90	5	009430006
7	270	150	15,5	20,20	5	009430007
8	282	150	18,5	20,20	5	009430008
9	282	150	19,5	20,20	5	009430009
10	282	150	20,5	22,10	3	009430010
11	282	150	21,5	22,10	3	009430011
12	282	150	22,5	22,10	3	009430012
13	282	150	23,5	23,50	3	009430013
14	282	150	24,5	23,50	3	009430014



943BX/S12 247,00 € 1 009430030
4-5-5,5-6-7-8-9
10-11-12-13-14 mm



943BX/D6 123,00 € 1 009430026
5-6-7-8-10-13 mm

943FL

chaves de caixa hexagonal flexível com punho



Ø mm	L mm	L1 mm	Ø mm	€	U	U
5	265	150	8	24,80	2	009430304
5,5	265	150	8	24,80	2	009430305
6	265	150	9	24,80	2	009430306
7	265	150	11	24,80	2	009430307
8	265	150	12	25,50	2	009430308
10	290	175	14	28,00	2	009430310



943FL/S6 153,00 € 1 009430320
5-5,5-6-7-8-10 mm

944BX

chave de caixa com punho sextavada profunda de binário elevado modelo longo



ISO 2236 UNI 6750

Ø mm	L mm	L1 mm	A1 mm	€	U	U
4	245	125	20	18,30	3	009440003
5	245	125	25	18,30	3	009440004
5,5	245	125	30	22,30	3	009440005
6	245	125	35	22,30	3	009440006
7	245	125	35	22,30	3	009440007
8	257	125	50	24,00	3	009440008
9	257	125	50	24,00	3	009440009
10	257	125	50	25,00	3	009440010
11	257	125	50	25,00	3	009440011
12	257	125	50	27,50	3	009440012
13	257	125	55	27,50	3	009440013
14	257	125	55	27,50	3	009440014



944BX/S12 283,00 € 1 009440062
4-5-5,5-6-7-8-9
10-11-12-13-14 mm



944BX/D6 139,00 € 1 009440056
5-6-7-8-10-13 mm

949

chaves de caixa com punho em T

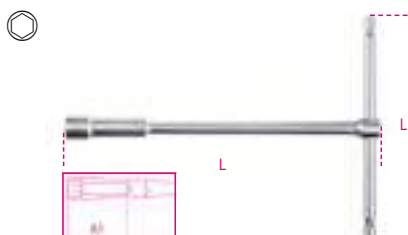

Ø mm	L mm	L1 mm	A1 mm	€	U	U
8	220	160	50	33,50	2	009490008
10	230	160	50	35,00	2	009490010
12	240	175	50	36,00	2	009490012
13	244	175	55	37,00	2	009490013
14	250	190	55	39,50	2	009490014
17	264	200	60	45,50	2	009490017



949/S6 226,00 € 1 009490076
8-10-12-13-14-17 mm

950

chaves de caixa simples hexagonal com punho em T

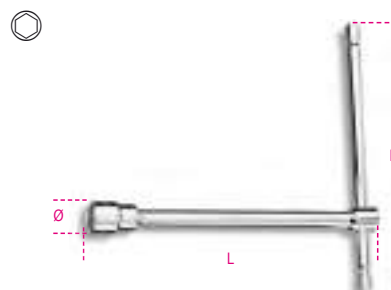

UNI 6742 DIN 3112

Ø mm	L mm	Ø mm	L1 mm	€	U	U
6	210	10,1	145	23,00	3	009500006
7	212	11,2	145	23,00	3	009500007
8	220	12,4	160	24,80	3	009500008
9	223	13,5	160	24,80	3	009500009
10	230	14,9	160	27,00	3	009500010
11	233	16,1	160	27,00	3	009500011
12	240	17,5	175	29,50	3	009500012
13	244	19,7	175	29,50	3	009500013
14	250	20,1	190	33,50	3	009500014
15	254	21,5	190	35,00	3	009500015
16	260	22,7	200	38,00	3	009500016
17	264	24,1	200	39,50	3	009500017
19	274	26,6	230	48,50	3	009500019
22	290	29,9	290	58,50	2	009500022
24	300	32,2	320	66,00	2	009500024
27	315	36,2	370	78,00	2	009500027



950/S9 282,00 € 1 009500079
7-8-10-11-12
13-14-17-19 mm
950/S14 460,00 € 1 009500082
6-7-8-9-10-11-12-13
14-15-16-17-19-22 mm



951 CHAVES COM PUNHO EM T E TRÊS MACHOS SEXTAVADOS



Quando a Beta lançou esta chave, em 1980, foi uma revolução. Concebida para parafusos de alta resistência, é sinónimo de manuseamento rápido, encaixe preciso e utilização versátil. Regulação livre do punho sextavado em T. Extremidades sextavadas desenhadas para transmissão da máxima força possível ao parafuso. A sua extensão permite a aplicação de apertos extraordinários aos parafusos. Constantes melhorias na produção traduziram-se, por exemplo, em acabamentos com jato de areia e extremidades sextavadas de arestas afiadas que garantem um melhor encaixe em quaisquer parafusos, mesmo nos danificados. A marcação a laser resulta num punho mais resistente. A marcação a laser torna a haste mais resistente. O novo modelo, 951 GP, foi desenvolvido em conjunto com técnicos e mecânicos de MotoGP e Superbike, com o objetivo de aumentar a velocidade de aparafusar/desaparafusar.

951

chaves em T com macho hexagonal articulado

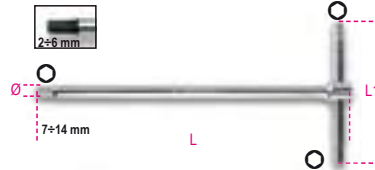

mm	L mm	L1 mm	Ø mm	€	🔧	📦
2	125	63	4,0	21,10	5	009510521
2,5	150	63	4,0	21,10	5	009510525
3	150	63	4,0	21,10	5	009510530
3,5	175	76	5,5	21,70	5	009510535
4	175	76	5,5	21,70	5	009510540
4,5	195	87	6,5	23,80	5	009510545
5	195	87	6,5	23,80	5	009510550
6	215	99	8,0	27,50	5	009510560
7	230	109	9,0	29,50	5	009510570
8	250	122	10,0	29,50	5	009510580
9	265	132	11,0	37,00	5	009510590
10	280	142	12,0	37,00	5	009510610
12	305	160	15,0	50,50	3	009510620
14	330	178	17,0	60,00	3	009510640



	€	🔧	📦
951/S6 2,5-3-4-5-6-8 mm	145,00	1	009510687
951/S8 2-2,5-3-3,5-4-4,5-5-6 mm	182,00	1	009510693
951/S14 2-2,5-3-3,5-4-4,5-5-6-7-8-9-10-12-14 mm	425,00	1	009510695



	€	🔧	📦
951/SP6 3-4-5-6-8-10 mm	185,00	1	009510696
951/SPV	34,00	1	009510697



951AS

chaves em T com macho hexagonal articulado

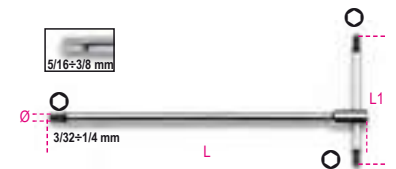

"	L mm	L1 mm	Ø mm	€	🔧	📦
3/32	125	63	4,0	28,50	2	009510750
7/64	150	63	4,0	28,50	2	009510751
1/8	150	63	4,0	28,50	2	009510752
9/64	175	76	5,5	29,50	2	009510753
5/32	175	76	5,5	29,50	2	009510754
3/16	195	86	6,5	32,00	2	009510755
7/32	215	99	8,0	32,00	2	009510757
1/4	230	109	9,0	36,50	2	009510758
5/16	250	122	10,0	37,00	2	009510759
3/8	280	142	12,0	45,50	2	009510760

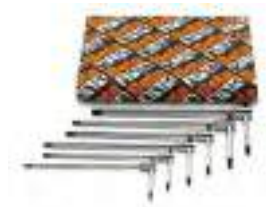

	€	🔧	📦
951AS/S6X 1/8-3/16-7/32-1/4-5/16-3/8	212,00	1	009510771

951GP

chave em T com macho sextavado

A chave Beta 951GP é sinónimo de um ajuste rápido e preciso.

Concebida para satisfazer alguns requisitos importantes do mundo das corridas: desenvolver valores de binário elevados e garantir um aperto rápido.

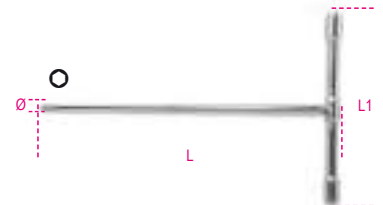

mm	L mm	L1 mm	Ø mm	€	🔧	📦
3	185	130	5	20,80	3	009511530
4	214	150	5	21,80	3	009511540
5	240	165	6	25,00	3	009511550
6	271	180	7	29,00	3	009511560
8	300	200	10	37,00	3	009511580
10	310	200	12	46,00	3	009511610



	€	🔧	📦
951GP/S6 3-4-5-6-8-10 mm	180,00	1	009511687

951TX

chaves em T com pontas para parafusos de perfil Torx®, articulado



Ø	L	L1	Ø	€	U	PC
mm	mm	mm	mm			
T6	125	63	4	26,00	3	009510806
T7	125	63	4	26,00	3	009510807
T8	125	63	4	27,00	3	009510808
T9	125	63	4	27,00	3	009510809
T10	150	63	4	27,50	3	009510810
T15	150	63	4	27,50	3	009510815
T20	175	76	5	29,00	3	009510820
T25	175	76	5	29,00	3	009510825
T27	195	87	6	30,50	3	009510827
T30	195	87	6	30,50	3	009510830
T40	215	99	7	35,50	3	009510840
T45	230	109	8	37,50	3	009510845
T50	250	122	9	40,50	3	009510850



	€	U	PC
951TX/S6 T8-T10-T15-T20-T25-T30	170,00	1	009510866
951TX/S13 T6-T7-T8-T9-T10-T15-T20-T25 T27-T30-T40-T45-T50	393,00	1	009510863

952 CHAVES DE CAIXA COM CARDAN E CABO EM T

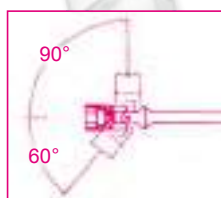

O segredo do sucesso desta chave é o pré-posicionamento preciso e fiável. A junta articulada mantém a sua função ao longo dos anos, sem necessidade de ajustes. Ângulo de rotação: 60°. Possibilidade de utilização a 90° em posição fixa. Cabo em T deslizante, com possibilidade de bloqueio em qualquer posição ao longo de toda a extensão. Marcação de três tamanhos na cabeça.

952

chaves de caixa hexagonais com cardan e cabo em T

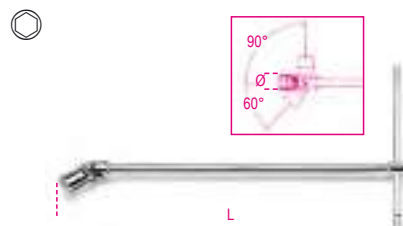

UNI 6743

mm	Ø	L	€	U	PC
mm	mm	mm			
6	9,5	395	35,50	5	009520006
7	10,7	395	35,50	5	009520007
8	12,1	395	35,50	5	009520008
9	13,2	395	35,50	5	009520009
10	14,6	400	38,00	5	009520010
11	15,8	400	38,00	5	009520011
12	17,0	400	38,00	5	009520012
13	18,7	432	41,00	5	009520013
14	19,7	432	41,00	5	009520014
15	20,9	450	50,50	3	009520015
16	22,0	450	50,50	3	009520016
17	23,4	450	50,50	3	009520017
18	24,7	450	50,50	3	009520018
19	26,0	500	61,50	3	009520019
20	27,4	500	61,50	3	009520020
21	28,5	500	61,50	3	009520021
22	29,7	500	61,50	3	009520022
24	32,4	500	61,50	3	009520024



	€	U	PC
952/S7 8-10-11-13-14-17-19 mm	305,00	1	009520074
952/S10 7-8-10-11-12-13- 14-15-17-19 mm	429,00	1	009520080
952/S18 6-7-8-9-10-11-12 13-14-15-16-17 18-19-20-21-22-24 mm	845,00	1	009520083



	€	U	PC
952/D7 7-8-10-12-13-14-17 mm	280,00	1	009520079

852



852 1/4

79,85

952AS

chaves de caixa hexagonais com cardan e cabo em T

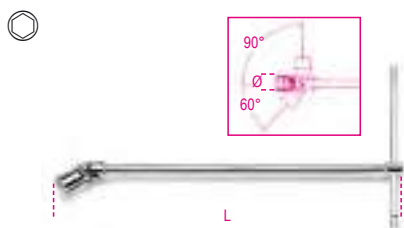

Ø"	Ø mm	L mm	€		
1/4	9,5	395	38,50	2	009520256
5/16	12,1	395	38,50	2	009520258
3/8	14,6	400	41,50	2	009520260
7/16	15,8	400	41,50	2	009520261
1/2	18,7	432	47,00	2	009520263
9/16	19,7	432	50,50	2	009520264
5/8	22,0	450	53,50	2	009520266
11/16	23,4	450	53,50	2	009520267
3/4	26,0	500	66,50	2	009520269

952L

chaves de caixa hexagonais com cardan e cabo em T série longa

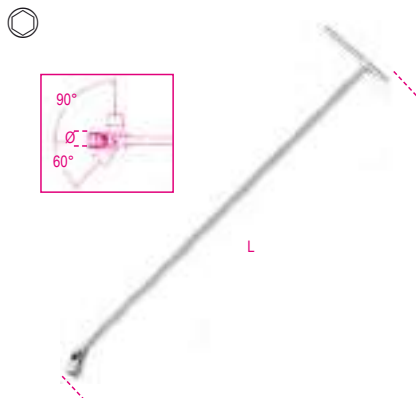

Ø mm	Ø mm	L mm	€		
10	14,6	930	97,50	1	009520410
12	17,0	1063	97,50	1	009520412
13	18,7	1100	97,50	1	009520413
14	19,7	1100	97,50	1	009520414
15	20,9	1100	109,00	1	009520415
16	22,0	1100	109,00	1	009520416
17	23,4	1100	109,00	1	009520417
18	24,7	1100	109,00	1	009520418
19	26,0	1100	127,00	1	009520419

Beta

952FTX

chaves de caixa com cardan e cabo em T, para parafusos com perfil Torx®

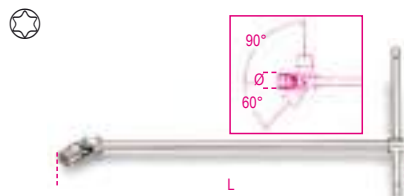

Ø mm	L mm	€		
E6	8 392	41,50	2	009520106
E7	9 392	41,50	2	009520107
E8	10 395	48,00	2	009520108
E10	13 400	49,00	2	009520110
E12	15 440	59,00	2	009520112
E14	17 490	72,00	2	009520114
E16	19 490	72,00	2	009520116
E18	21 490	72,00	2	009520118
E20	23 490	72,00	2	009520120



952FTX/S9	€		
E6-E7-E8-E10-E12	530,00	1	009520141
E14-E16-E18-E20			

953

chaves em T com macho hexagonal articulado

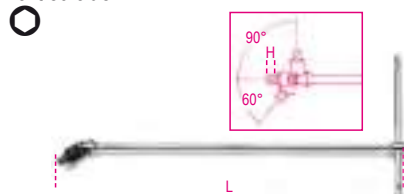

UNI 6754

mm	H mm	L mm	€		
3	5	395	36,50	5	009530130
3,5	6	395	36,50	3	009530135
4	6	395	36,50	5	009530140
4,5	7	395	36,50	3	009530145
5	7	395	36,50	5	009530150
6	9	400	39,50	5	009530160
7	10	425	43,50	3	009530170
8	11	425	43,50	5	009530180
10	13	440	52,00	5	009530200



953/S5	€		
3-4-5-6-8 mm	193,00	1	009530305
953/S9	361,00	1	009530301
3-3,5-4-4,5			
5-6-7-8-10 mm			

953TX

chaves em T com macho de perfil Torx® articulado

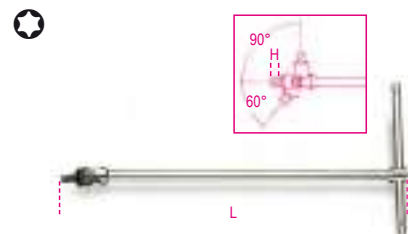

Ø	H mm	L mm	€		
T20	11	396	44,50	2	009530020
T25	11	396	44,50	2	009530025
T27	11	396	44,50	2	009530027
T30	13	400	49,00	2	009530030
T40	13	400	49,00	2	009530040
T45	13	426	50,50	2	009530045
T50	14	442	59,00	2	009530050
T55	14	442	59,50	2	009530055



953TX/S8	€		
T20-T25-T27-T30	401,00	1	009530060
T40-T45-T50-T55			

Beta

Beta

REPARAÇÃO DE VEÍCULOS

As nossas ferramentas para reparação de veículos, usadas pelos profissionais mais exigentes, são desenvolvidas e fabricadas para cumprir as normas mais rígidas a nível mundial, e são testadas com regularidade sob as mais difíceis condições de trabalho.

Há mais de 50 anos que temos o orgulho de trabalhar de mãos dadas com os melhores, que nos ajudam a melhorar continuamente os nossos produtos e são testemunhas dos mais elevados padrões de qualidade.

As ferramentas de reparação de veículos encontram-se nas seguintes secções:

Diagnóstico

itens 1438 a 1499
itens 1758VT a 1760TMC

Motor

itens 955 a 989A
itens 1438 a 1499

Óleo e filtros

itens 1438 a 1499
itens 1877 a 1885

Sistema elétrico

itens 1438 a 1499

Arrancadores

itens 1498BC/12 a 1498/40A

Transmissão

itens 1438 a 1499

Suspensão

itens 1549 a 1569CP

Travões

itens 1438 a 1499

Rodas

itens 955 a 989A

Carroçaria

itens 1302 a 1369
itens 1763 a 1767A

Outros equipamentos

itens 1875LT a 3067

Elevação

itens 3029/2T a 3067/70-13T



955

chave tubular para velas

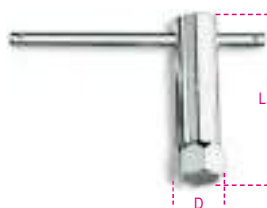

mm -"	D mm	L mm	€	W	U
16	21	86	18,10	3	009550016
5/8	20,8	86	18,10	3	009550021
13/16					

956C

chaves de caixa para velas quadra fêmea de 1/2"



ISO 11168

mm -"	Ø mm	L mm	€	W	U
14	18,8	70	34,00	3	009560008
9/16	16	21,4	70	34,00	3 009560010
5/8	17,8	23,6	70	34,00	3 009560011
11/16	20,8	27,0	70	34,00	3 009560012
13/16					

956E

chaves de caixa para velas quadra fêmea de 3/8"



ISO 11168

mm -"	Ø mm	L mm	€	W	U
14	18,8	70	37,00	3	009560018
9/16	16	21,4	70	37,00	3 009560020
5/8	17,8	23,6	70	37,00	3 009560021
11/16	20,8	27,0	70	37,00	3 009560022
13/16					

956F

chaves de caixa para velas quadra 3/8"



mm -"	Ø mm	L mm	€	W	U
14	18,8	70	41,50	1	009560114
9/16	16	20,5	70	51,50	1 009560116
5/8					

Beta

956L

chaves de caixa para velas quadra de 1/2", extremidades hexagonal, série longa



mm -"	Ø mm	L mm	€	W	U
14	19,0	250	69,50	2	009560214
9/16	16	21,0	250	71,50	2 009560216
5/8	17,8	24,0	250	75,50	2 009560217
11/16					

957

chaves em T para velas com cardan

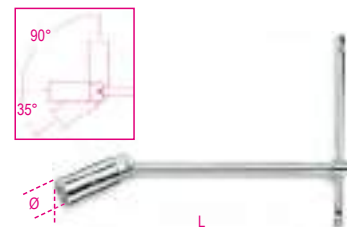

ISO 11168

mm -"	Ø mm	L mm	€	W	U
16	21,4	275	52,00	3	009570000
5/8	20,8	27,0	275	61,50	3 009570001
13/16					

959

chaves em T para velas com cardan série normal

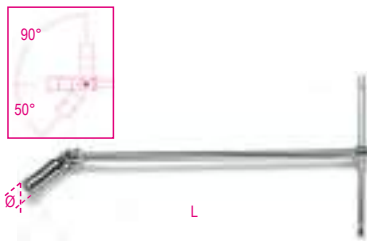

ISO 11168

mm -"	Ø mm	L mm	€		
14	18,8	483	60,50	3	009590009
9/16					
16	21,4	483	67,50	3	009590010
5/8					
20,8	27,0	527	89,50	3	009590011
13/16					

959R

aplicações em borracha e molas de substituição para artigos 956C - 956E - 957 - 959

	€		
959R/14 956C/14-956E/14	6,30	3	009590223
959R/16 956C/16-956E/16 957/16-959/16	6,30	3	009590224
959R/17,8 956C/17,8-956E/17,8	6,30	3	009590225
959R/20,8 956C/20,8-956E/20,8 957/20,8-959/20,8-959L	6,30	3	009590226

960

chave de caixa para injectores de motores Diesel, quadra fêmea de 1/2"

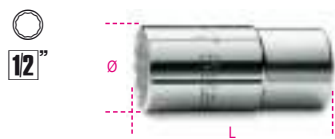

mm	Ø mm	L mm	€		
27	36,5	77	39,50	2	009600027

960A

chave de caixa para injectores de motores Diesel, quadra fêmea de 1/2"

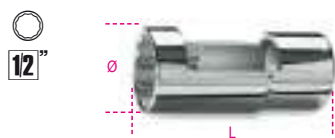

mm	Ø mm	L mm	€		
27	36,5	77	57,50	2	009600017

960BC/C5

jogo de 5 saca-injectores

Inclui:

- 1 chave de caixa sextavada, 25 mm
- 1 chave de caixa sextavada, 27 mm
- 1 chave de caixa sextavada, 29 mm
- 1 chave de caixa sextavada, 30 mm
- 1 chave de caixa bi-sextavada, 28 mm



960BC/C5	€		
	177,00	1	009600280

280x160x55 mm - 1,9 kg

960ER

saca-anilhas de injectores

Extremidade rosçada



L mm	€		
350	70,50	1	009600726

960F

chave de caixa para porta-injectores



Ø mm	Ø1 mm	1 mm	2 mm	€		
28,3	22	32	22	45,50	1	009600148

960G

chave de caixa para injectores especialmente indicada para os injectores Diesel dos camiões Mercedes-Benz



Ø mm	Ø1 mm	mm	L mm	€		
28,5	22	32	122	48,00	1	009600151

960L

chave de caixa para injectores



Ø mm	Ø1 mm	L mm	€		
30	22	122	52,00	1	009600153

960M

chave de caixa para injectores

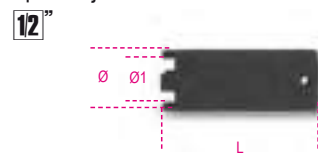

Ø mm	Ø1 mm	L mm	€		
28,5	22	72	38,00	1	009600154

960H/C4

jogo de chaves de caixa para porta-injectores



960H/C4	€		
	137,00	1	009600152

960SL

chaves de caixa para sonda Lambda com quadra fêmea de 1/2"



	Ø mm	€		
960SL 85	33	68,50	2	009600085
○ 22xL= 85 mm				
960SL 110	33	77,50	2	009600110
○ 22xL= 110 mm				

960SN

chaves para velas de incandescência de motores Diesel



mm	Ø mm	mm	L mm	€		
8	12,0	1/4	60	58,00	2	009600834
9	13,3	1/4	60	58,00	2	009600835
10	14,5	3/8	70	69,00	2	009600836

960T/C11

Conjunto de chaves de caixa para remoção/ instalação de sensores

Inclui:

- 1 chave de caixa de sextavada de dupla entrada, tamanho 1" - 11/16" (para sensores da pressão do óleo)
- 1 chave de caixa sextavada aberta, 29 mm, para sensores de oxigénio
- 1 chave de caixa bi-sextavada aberta, 27 mm, para injetores
- 1 chave de caixa sextavada aberta, 22 mm, para vacuostatos
- 1 chave de caixa sextavada aberta, 22 mm, 80 mm de comprimento, para sensores de oxigénio
- 1 chave de caixa sextavada aberta, 22 mm, 90 mm de comprimento, para sensores de oxigénio
- 1 chave de caixa sextavada aberta, 22 mm, compacta, 30 mm de comprimento, para sensores de oxigénio
- 1 chave de caixa sextavada aberta, 22 mm, compacta, 50 mm de comprimento, para sensores de oxigénio
- 1 chave de caixa sextavada e bi-sextavada aberta, 22 mm, compacta, 34 mm de comprimento, para sensores de oxigénio
- 1 macho M18x1.5



22 - 29 mm

960T/C11 226,00 1 009600031

330x270x25 mm

960T/A

chave de caixa sextavada, 29 mm, para sensores de oxigénio



29 mm 90 mm 26,50 1 009600032

960T/B

chave de caixa bi-sextavada, 27 mm, para injetores



27 mm 85 mm 23,50 1 009600033

960T/C

chave de caixa bi-sextavada, 22 mm, para vacuostatos



22 mm 88 mm 20,70 1 009600034

960T/F

chave de caixa sextavada dupla, tamanho 1" - 1 1/16", para sensores de pressão de óleo



1 - 1 1/16" 28 mm 74 mm 16,20 1 009600037

960T/G

chave de caixa sextavada, 22 mm, formato tipo tubo



22 mm 25 mm 98 mm 46,00 1 009600038

960T/H

chave sextavada e bi-sextavada, 22 mm, compacta, 34 mm comprimento, para sensores de oxigénio



22 mm 34 mm 55 mm 17,20 1 009600039

960/22EP

chave dupla articulada, para sondas Lambda

Cabeça dupla sextavada/bi-sextavada e junta 180° para extrema versatilidade



300 mm 22 mm 22 mm 62,00 1 009600052

960/C6

Chave de caixa sextavada fêmea 3/8" para instalar sensores de temperatura de gases de escape

O kit inclui:

- 3 packs de versão curta, 13, 14 e 17mm
- 3 packs de versão longa, 13, 14 e 17mm



960/C6 95,50 1 009600055

170x120x50 mm

960/D

chaves de caixa sextavadas, série longa, para remover/instalar sensores de temperatura de gases de escape



13 mm 14,90 1 009600073
14 mm 14,90 1 009600074
17 mm 17,90 1 009600077

960YP

chaves de caixa sextavadas para remover/installar sensores de temperatura de gases de escape

38"



mm	€	🔧	📦
13	15,70	1	009600063
14	16,30	1	009600064
17	21,70	1	009600067

960AVE

dispositivo de teste de injectores eléctricos diesel common rail



960AVE	€ 305,00	🔧 1	📦 009600245
--------	----------	-----	-------------

≡ 430x310x50 mm - 📦 2,0 kg

960EPC/L

Conjunto de ferramentas de extração do eletrodo de velas incandescentes M8x1 - M9x1 - M10x1 - M10x1.25



ZONA DI ROTTURA

960EPC/L	€ 1.000,00	🔧 1	📦 009600890
----------	------------	-----	-------------

≡ 270x230x80 mm - 📦 2 kg

960E-PI/P

extractor de anilhas de injector

- Rosca macho M10 para utilização com o extractor de percussão (Beta 1540)



960E-PI/P	€ 78,50	🔧 1	📦 009600706
-----------	---------	-----	-------------

≡ 300x90x60 mm

960KC-M8/M9/M10

Jogo de ferramentas para remoção de velas de incandescência danificadas ou partidas

- Para velas de incandescência com rosca M8-M9-M10



960KC-M8/9/10	€ 510,00	🔧 1	📦 009600801
---------------	----------	-----	-------------

≡ 380x290x50 mm - 📦 2,3 kg

960KPC

Extractor por impulso reversível com binário ajustável para velas de incandescência

14"

CE



960KPC	€ 365,00	🔧 1	📦 009600780
--------	----------	-----	-------------

🔧 8-9-10-11-12 mm
≡ 420x185x60 mm - 📦 2,8 kg

960UC

Jogo de ferramentas para extração de velas de incandescência M8-M9-M10 com pontas danificadas



960UC	€ 580,00	🔧 1	📦 009600900
-------	----------	-----	-------------

≡ 270x230x80 mm - 📦 2,6 kg

960P

aparelho de teste de compressão/descompressão com acessórios e adaptadores



960P	€ 300,00	🔧 1	📦 009600777
------	----------	-----	-------------

≡ 350x320x95 mm - 📦 1,9 kg

960PI

jogo de escareadores para limpeza do alojamento dos injectores em estojo de plástico

Para remover resíduos do alojamento do injector

- Escareador plano, Ø 19 - 15 mm, para injectores universais
- Escareador plano, Ø 17 - 17 mm, para injectores Delphi/Bosch (BMW/PSA/Renault/Ford)
- Escareador plano, Ø 19 - 17 mm, para injectores Bosch (Mercedes CDI).
- Escareador angular, Ø 21 - 17 mm, para injectores Fiat/Iveco
- Punho



960PI	€ 140,00	🔧 1	📦 009600215
-------	----------	-----	-------------

≡ 250x130x50 mm - 📦 600 g

960PI/C19

jogo de 19 ferramentas para limpeza de base de injetores

Inclui:

- 11 mandris planos, Ø: 14/14 mm - 15.5/15.5 mm - 15/19 mm - 17/19 mm - 17/17.5 mm - 17/19 mm - 17/19.5 mm - 17/20 mm - 18/21 mm - 19 mm - 20/21 mm
- 4 mandris angulares, Ø: 15.5/15.5 mm - 17/17 mm - 17.5/20.5 mm - 17/21 mm
- Acessórios para mandris e punhos



960PI/C19 € 350,00 1 009600217

360x230x60 mm

960PI/K36

kit de escovas para limpeza do alojamento dos injetores

1/4



DIN 3126 E6,3

960PI/K36 € 221,00 1 009600218

350x255x74 mm - 1253 g

960PI/S

kit limpeza do alojamento dos injetores

Inclui:

- 3 escovas de aço, Ø 18, 22, 25 mm, para limpeza de suportes de injetores
- 2 escovas, Ø 14 e 16 mm para limpeza do fundo dos suportes
- 6 tampas para o acesso à câmara de combustão
- 1 escova para limpeza do acesso à câmara de combustão
- 1 porta-bits flexível com punho

1/4



960PI/S € 185,00 1 009600214

360x140x50 mm - 700 g

960VTC

dispositivo para teste de fugas para cilindros de motores a gasolina após a introdução de ar comprimido no cilindro, o dispositivo permite testar se existem fugas de compressão



960VTC € 322,00 1 009600261

373x295x70,6 mm - 2,3 kg

960RPI

Soprador do alojamento dos injetores

Para velas de incandescência M8x1 - M9x1 - M10x1 - M10x1.25



960RPI € 223,00 1 009600940

960PMC

bomba manual para regulação e controlo de injetores Diesel



Bar Max. 600 € 880,00 1 009600200

961P6

videoscópio electrónico com sonda flexível



CE

- Suporta cartões SD (8 GB)
 - Suporta memórias flash (8 GB)
 - Memória interna: 128M
 - Saída para TV
 - Suporta formato de vídeos (MP4, AVI, 3GP)
 - 4 LEDs
 - Alimentação por porta USB (bateria embutida)
- ESPECIFICAÇÕES**
- Pixels do sensor: 640x480
 - Resolução máxima: 320x240
 - Comprimento da sonda: 1 m
 - Diâmetro da câmara: 6 mm
 - Formato de vídeos: MPEG4, 3GP, AVI, ASF
 - Formato de fotografias: JPEG
 - Ângulo de disparo: 0+180°
 - Saída de dados: Cabo USB e cartão SD
 - Alimentação: bateria 3.7V 2000 mAh

961P6 € 870,00 1 009610000

961P6/S

sondas flexíveis, 6 mm

IP67



L mm	€	1	009610006
961P6/S 1 1000	375,00	1	009610006
961P6/S 2 2000	420,00	1	009610262
961P6/S 3 3000	475,00	1	009610263

962

ferros de desmonta



L mm	A mm	€	5	009620003
300	21	28,50	5	009620003
400	25	33,50	5	009620004
500	27	43,00	3	009620005
600	27	56,50	3	009620006

962C



962C 277

962P

alavanca de pneus com proteção anti-riscos



L	A	€	🔧	🚚
mm	mm			
490	25	105,00	1	009620049

962M

ferramenta para desmontagem/ montagem de pneus

Instalação de pneus runflat e baixo perfil em todos os equipamentos.

- mordentes anti-riscos
- base de alavanca para remoção do pneu



962M	€	🔧	🚚
	375,00	1	009620501

963

alavanca com extremidades chata e pontiaguda



L	A	€	🔧	🚚
mm	mm			
400	23	42,50	5	009630001

964

alavanca com extremidades pontiaguda e em cunha



L	A	€	🔧	🚚
mm	mm			
400	46	38,50	5	009640001

965

jogo de alavancas com pontas curvadas



L	A	L1	€	🔧	🚚
mm	mm	mm			
300	16	185	19,80	2	009650013
450	20	312	28,00	2	009650014
600	20	462	32,50	2	009650016



965/S3	€	🔧	🚚
	80,50	1	009650019

966/C3

Jogo 3 alavancas com cabeça articulada curvada

- Rotação da cabeça a 200°
- Bloqueio automático na posição pretendida



966/C3	€	🔧	🚚
L=200-250-300 mm	148,00	1	009660103

355x140x65 mm - 1,8 kg

720LS

chaves de impacto, série longa



720LS 36	Ø	L	Ø1	€	🔧	🚚
	mm	mm	mm			
	36	48,0	78	29	69,00	2

969B

chave de caixa para aperto da porca do cubo

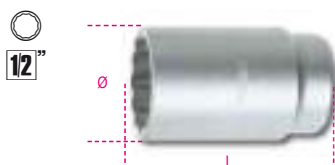

969B	Ø	L	€	🔧	🚚
	mm	mm			
24	36,0	76	25,00	1	009690124
27	36,0	76	25,50	1	009690127
30	40,0	76	26,50	1	009690130
31	42,0	76	27,00	1	009690131
32	42,5	76	29,00	1	009690132
34	45,0	76	32,00	1	009690134
35	46,0	76	32,50	1	009690135
36	49,0	76	37,50	1	009690136

969/C5

jogo de 5 chaves de caixa para cubos de roda em estojo de plástico

12"



969/C5	€	🔧	🚚
	158,00	1	009690201

969B 30-32-34-35-36

970B

chave de caixa para aperto da porca do cubo Fiat Daily

1"

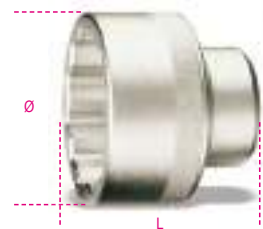

970B	Ø	L	€	🔧	🚚
	mm	mm			
65	88	75	123,00	1	009700010

970IVECO

chave de caixa para cubos de roda Iveco Daily para versões a partir de 2014

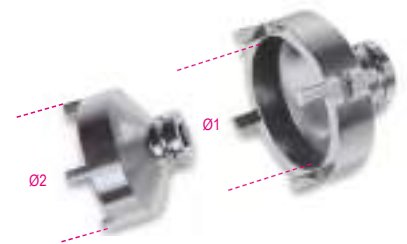

970IVECO	Ø1	Ø2	€	🔧	🚚
	mm	mm			
	61,5	74,8	74,00	1	009700011

Beta
Quality Tools

Beta

971/C8

chave de aperto para válvulas de pneus, com acessórios e sistema de controlo de pressão para um aperto controlado



971/C8 € 465,00 1 009710108

	583/6	1,2+6 Nm
	892/0	
	862TX	T10-T15-T20
	900L	11-12 mm
	986 78	

972/C4BMW

kit para remoção de porcas anti-roubo, para BMW e Mini



972/C4 BMW € 269,00 1 009720004

516x145x66 mm - 3,8 kg

972/C10

kit extratores para cubos de roda danificados

para utilização em cubos anti-roubo e convencionais



972/C10 € 339,00 1 009720010

290x250x60 mm - 2,4 kg

973

Conjunto de 4 capas para rodas em nylon

Adequadas para as seguintes jantes:
14" ÷ 18" item número 009730014
19" ÷ 22" item número 009730019



- preserva e protege de riscos e poeiras
- previne deterioração precoce da borracha dos pneus de verão/inverno armazenados
- icon identificador da roda (direita/esquerda frente ou direita/esquerda traseira)
- com pegas para fácil transporte
- em nylon, lavável

973 14-18 € 119,00 1 009730014
973 19-22 € 132,00 1 009730019

978 - 979

chaves de cruz para porcas de rodas

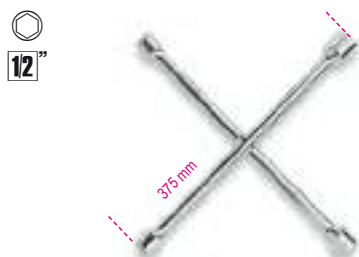

UNI/ISO 6788 DIN 3119

978 € 75,50 2 009780001
17x19x21x22 mm
979 € 75,50 2 009790001
17x19x22x1/2 mm

982

chaves de cruz para porcas de rodas

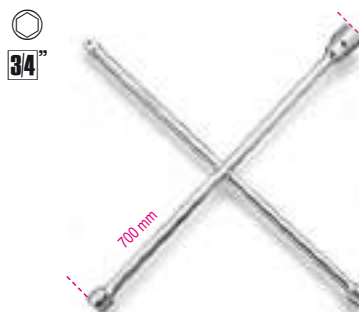

UNI/ISO 6788 DIN 3119

24x27x32x3/4 mm € 183,00 1 009820001

983PM

escova abrasiva para limpeza de cubos de roda



Ø1 90 mm
Ø2 150 mm
€ 88,00 1 009830010

983 PM/R-DA

discos abrasivos, par, para item 983PM



Ø 150 mm € 81,50 1 009830050

984

Alicate para tampa de plástico da porca da roda



L 195 mm H 4 mm € 30,00 1 009840005

985/B7

jogo 7 pinos-guia para rodas

- Tamanhos:
- M12x1.25 macho
 - M12x1.25 fêmea
 - M12x1.5 macho
 - M12x1.5 fêmea
 - M14x1.25 macho
 - M14x1.5 macho
 - M16x1.5 macho



C985/B7 € 117,00 1 009850007



985M

pinos-guia macho para rodas



	L mm	€		
985M M12X1,25	150	15,20	1	009850101
985M M12X1,50	150	15,20	1	009850102
985M M14X1,25	150	15,70	1	009850103
985M M14X1,50	150	15,70	1	009850104
985M M16X1,50	150	17,30	1	009850105

985F

pinos-guia fêmea para rodas



	L mm	€		
985F M12X1,25	150	20,30	1	009850106
985F M12X1,50	150	21,50	1	009850107

986 48

Chave de fendas para válvulas de pneus, modelo curto

Válvula de retenção automática



L mm	L1 mm	€		
18	48	17,30	1	009860048

986 78

Chave de fendas para válvulas de pneu

Válvula de retenção automática



L mm	L1 mm	€		
18	78	17,30	1	009860078

986PT

chave para válvulas de pneus, pré-calibrada, 0.4 Nm, retenção automática da válvula

Mecanismo de proteção da calafetagem da válvula



L mm	L1 mm	€		
19	120	60,50	1	009860140

987

Alavanca para válvulas de pneus com protecção em borracha



L mm	€		
310	35,50	1	009870001

987AR

alavanca para válvulas de pneus com apoio anti-riscos

- apoio em borracha e nylon para jantes de liga e de ferro
- encaixe rápido da válvula, sem necessidade de apertar



L mm	€		
305	117,00	1	009870021

987P

alavanca para válvulas de pneus em plástico

Punho permite trabalhar com a chave no mecanismo interno da válvula



L mm	€		
335	29,50	1	009870011

988/K4

Jogo de 4 escopros planos anti-riscos em plástico

- Particularmente adequados para remoção de vedantes adesivos em jantes de liga leve
- Arestas de corte em 3 lados para utilização mais versátil



	€		
988/K4 A= 19-21-25-38 mm	31,00	1	009880104

989

alicate para pesos



L mm	€		
250	56,50	2	009890001

989A

Alicate de remoção de pesos de equilíbrio das rodas



Perfil com design específico para não marcar as jantes

L mm	€		
989A 220	38,00	1	009890011

989B

alicate para remoção de pesos de equilíbrio das rodas

Funções:

- remoção de pesos adesivos para jantes de liga
- remoção de pesos para jantes de ferro
- martelo com cobertura PE-HD amovível para pesos adesivos e jantes de ferro
- mordentes de peso para jantes de ferro



L mm	€		
989B 230	72,50	1	009890015

Beta
Quality Tools

990

pinça de pontas finas,
direitas e estriadas em aço inoxidável



L mm 130 € 13,20 5 009900001

991

pinça de pontas finas,
curvas e estriadas em aço inoxidável



L mm 130 € 15,90 5 009910001

992

pinça com guia, pontas finas
direitas e estriadas em aço inoxidável



L mm 150 € 16,70 5 009920001

993

pinça com guia, pontas finas
curvas e estriadas em aço inoxidável



L mm 145 € 17,90 5 009930001

993PL

pinça com guia, pontas finas
curvas e estriadas em aço inoxidável
cobertura em PVC



L mm 150 € 17,90 3 009930010

993G

pinça com guia, pontas finas,
encurvadas e estriadas
em aço inoxidável



L mm 160 € 16,40 3 009930030

994

pinça com pontas largas,
direitas e estriadas em aço inoxidável



L mm 150 € 13,70 5 009940001

994PL

pinça com pontas largas,
direitas e estriadas em aço inoxidável
cobertura em PVC



L mm 150 € 16,40 3 009940010

994TF

pinça com pontas largas,
direitas e estriadas em aço inoxidável
anti-magnético e resistente a ácidos



L mm 150 € 21,90 3 009940020

996

pinça com pontas direitas
espatuladas em aço inoxidável



L mm 150 € 14,50 5 009960001

998

pinça cruzada de pontas largas,
direitas e estriadas em aço inoxidável



L mm 155 € 25,00 5 009980001

999

pinça com pontas chatas
e arredondadas em aço inoxidável
anti-magnético e resistente a ácidos



L mm 115 € 19,90 3 009990011

999A

pinça com pontas curtas e extra-finas
em aço inoxidável anti-magnético
e resistente a ácidos



L mm 120 € 17,20 3 009990015

999B

pinça com pontas direitas de grande
resistência em aço inoxidável
anti-magnético e resistente a ácidos



L mm 120 € 17,60 3 009990017

999C

pinça com pontas direitas e extra-finas
em aço inoxidável anti-magnético
e resistente a ácidos



L mm 110 € 19,30 3 009990019

999D

pinça com pontas extra-finas angulares em aço inoxidável anti-magnético e resistente a ácidos



L mm 115 € 21,30 3 009990021

999E

pinça com pontas curvas extra-finas em aço inoxidável anti-magnético e resistente a ácidos



L mm 120 € 19,30 3 009990023

999G

pinça de pontas direitas extra-finas com dispositivo de blocagem em aço inoxidável anti-magnético e resistente a ácidos



L mm 140 € 19,30 3 009990027

999/B6N

jogo de 6 pinças, antimagnéticas e resistentes a ácidos



999/B6N € 124,00 1 009990060
999-999A-999B
999C-999D-999E

1002

pinça de pontas redondas estriadas com bloqueio, em aço inoxidável



L mm 160 € 31,00 2 010020001

1008

alicate de pontas chatas longas, com estrias, e punhos de dupla camada de PVC



ISO 5745

L mm 160 L1 mm 51,5 € 28,50 5 010080006

1008BM

alicate de pontas chatas longas, com estrias, e punhos bi-material



ISO 5745

L mm 160 L1 mm 51,5 € 34,50 3 010080036

1009

alicates de pontas estriadas extra-longas, punhos com dupla camada de PVC anti-deslizamento



ISO 5745

L mm 160 L1 mm 56,5 € 28,50 2 010090006

1009L/A

alicate para trabalhos especiais de pontas semi-redondas extra-longas, com estrias, e punhos de dupla camada de PVC



L mm 283 L1 mm 80 € 34,50 2 010090008

1009L/B

alicate para trabalhos especiais de pontas semi-redondas extra-longas, curvas a 45°, com estrias, e punhos de dupla camada de PVC



L mm 273 L1 mm 73 € 35,00 2 010090009

1009L/C

alicate para trabalhos especiais de pontas semi-redondas extra-longas, curvas a 90°, com estrias, e punhos de dupla camada de PVC



L mm 253 L1 mm 45 € 37,50 2 010090010

Beta

Beta

1009L/D

alicate extralongo, nariz dentado duplo giratório, pegas com revestimento duplo em PVC antiderrapante



L mm 342 L1 mm 71 € 41,50 1 010090058

1009L/DP

alicate curvo extralongo nariz dentado duplo giratório, 45°, pegas com revestimento duplo em PVP antiderrapante



L mm 336 L1 mm 66 € 41,50 1 010090059

1009L/DP-S2

Jogo de 2 alicates para trabalhos especiais de pontas semi-redondas extra-longas



1009L/DP-S2 € 83,00 1 010090060

1010

alicate de pontas redondas extra-longas e punhos de dupla camada de PVC



ISO 5745 L mm 160 L1 mm 51,5 € 28,50 2 010100006

1010BM

alicate de pontas redondas, com estrias, e punhos bi-material



ISO 5745 L mm 160 L1 mm 51,5 € 34,50 2 010100036

ALICATES DE FREIOS (TIPO SEEGER)

ALINHAMENTO PERFEITO

Os testes mostraram que os alicates de freios da Beta proporcionam um excelente alinhamento seeger (anel retentor), com base na geometria especial de cone reverso das pontas, obtida através da tecnologia exclusiva de prensagem a frio.



QUEBRA DE PONTAS REDUZIDA

Os alicates Beta estão equipados com pontas prensadas a frio embutidas, que proporcionam maior durabilidade em comparação com os concorrentes, tanto em termos de utilização como em caso de quedas acidentais.



1031/S4

Jogo de 4 alicates de freios



1031/S4 € 122,00 1 010310000
 1032 180 ○ 19 ÷ 60 mm
 1034 170 ○ 19 ÷ 60 mm
 1036 175 ● 19 ÷ 60 mm
 1038 175 ● 19 ÷ 60 mm

1032

alicates de freios interiores com pontas direitas e punhos em PVC



UNI 7914 DIN 5256 L mm 140x0,9 Ø mm 8÷12 € 27,00 5 010320013
 140x1,3 12÷25 € 26,50 5 010320014
 180 19÷60 € 28,50 5 010320017
 225 40÷100 € 35,00 3 010320021
 300 85÷200 € 49,00 2 010320028

1033

alicates de freios interiores com pontas curvas a 45° e punhos em PVC



UNI 7914 DIN 5256 L mm 140x0,9 Ø mm 8÷12 € 30,50 5 010330013
 140x1,3 12÷25 € 29,50 5 010330014
 180 19÷60 € 31,00 5 010330017
 225 40÷100 € 38,50 3 010330021

1034

alicates de freios interiores com pontas curvas a 90° e punhos em PVC



UNI 7914 DIN 5256 L mm 130x0,9 Ø mm 8÷12 € 30,50 5 010340013
 130x1,3 12÷25 € 29,50 5 010340014
 170 19÷60 € 31,00 5 010340017
 210 40÷100 € 38,50 3 010340021
 290 85÷200 € 54,50 2 010340028

1034L

alicate de freios interiores com pontas curvas a 90° e punhos em PVC



L mm	∅ mm	€	U	PC
190	40÷100	78,50	2	010340320

1036

alicates de freios exteriores com pontas direitas e punhos de PVC



UNI 7915 DIN 5254

L mm	∅ mm	€	U	PC
140x0,9	3÷10	29,00	5	010360013
140x1,3	10÷25	28,50	5	010360014
175	19÷60	29,50	5	010360017
225	40÷100	37,50	3	010360021
300	85÷200	58,50	2	010360028

1037

alicates de freios exteriores com pontas curvas a 45° e punhos em PVC



UNI 7915 DIN 5254

L mm	∅ mm	€	U	PC
140x0,9	3÷10	32,50	5	010370013
140x1,3	10÷25	31,00	5	010370014
175	19÷60	32,50	5	010370017
225	40÷100	40,00	3	010370021

1038

alicates de freios exteriores com pontas curvas a 90° e punhos em PVC



UNI 7915 DIN 5254

L mm	∅ mm	€	U	PC
135x0,9	3÷10	32,50	5	010380013
135x1,3	10÷25	31,00	5	010380014
175	19÷60	32,50	5	010380017
220	40÷100	40,00	3	010380021
300	85÷200	63,50	2	010380028

Beta

1039

alicate reversível com pontas direitas para freios interiores e exteriores com punhos em PVC



L mm	∅ mm	∅ mm	€	U	PC
150	10÷15	6÷25	68,50	2	010390015

1558/C4

ferramenta para anel retentor interno e externo, operada por parafuso

Encabadouro quadrado permite a aplicação de uma força elevada em ambas as condições de operação
Pontas fornecidas:
∅ 2.5-3-3.5 mm



∅ mm	∅ mm	€	U	PC
1558/C4 5,5 ÷ 77	5,5 ÷ 77	195,00	1	015580100

330x220x50 mm - 900 g

1044N

alicate ajustável, fosfatado, charneira sobreposta, punhos com revestimento em PVC antiderrapante
· modelo com 8 posições



L mm	A max mm	L1 mm	€	U	PC
250	46	48	27,00	5	010440025

1047

alicate ajustável de charneira fechada, com botão de bloqueio punhos com revestimento duplo em PVC antiderrapante

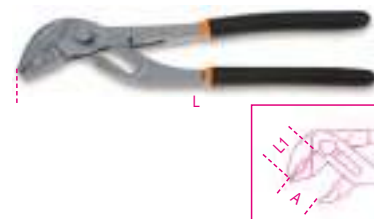

L mm	A max mm	L1 mm	€	U	PC
180	30	29	46,00	2	010470180
240	36	35	49,00	2	010470240
300	50	48	71,00	1	010470300

1047BM

alicate de charneira, botão de regulação, punho de 2 componentes



L mm	A max mm	L1 mm	€	U	PC
240	36	35	56,50	2	010470340

Beta

1048N - ALICATES DE CHARNEIRA FECHADA

PEGA EXCELENTE E MANUSEAMENTO PERFEITO

- Nova geometria do dente para uma fixação eficaz e segura em perfis hexagonais e cilíndricos
- Dentes reforçados por indução para maior durabilidade
- Maior ângulo da cabeça/punho para manuseamento ergonómico melhorado
- Retentor de contraste que evita o esmagamento acidental das mãos
- Punhos antiderrapantes com revestimento em PVC
- Manuseamento e conforto extraordinários graças à grande superfície de contacto do punho



1048N

alicate de charneira fechada, punhos anti-derrapantes com revestimento em PVC



ISO 8976

L mm	A max mm	L1 mm	S mm	€	🔧	📦
175	36	31	11	29,00	3	010480910
250	46	38	13	30,50	5	010480915
300	60	44	14.8	45,50	2	010480920
400	96	81	19	84,00	1	010480940

1048N/D3

jogo de alicates de charneira

cabeças fosfatadas



1048N/D3 175-250-300 mm	€ 105,00	🔧 1	📦 010480923
----------------------------	----------	-----	-------------

1048BM

alicate ajustável, charneira fechada, punhos de 2 componentes

• novo modelo com 9 posições



ISO 8976

L mm	A max mm	L1 mm	€	🔧	📦
250	48	39	48,50	3	010480215

1048VN

alicate ajustável de charneira fechada, lacado cor de laranja



ISO 8976

L mm	A max mm	L1 mm	€	🔧	📦
175	36	31	28,50	3	010480111
250	46	38	32,50	5	010480116
300	60	44	47,50	2	010480121

1050

alicate de pressão com dupla regulação



L mm	€	🔧	📦
220	86,50	2	010500022

1051

alicate de pressão com dupla regulação maxilas longas



L mm	€	🔧	📦
255	94,50	2	010510025

1051GM

alicate de pressão com dupla regulação, maxila oscilante

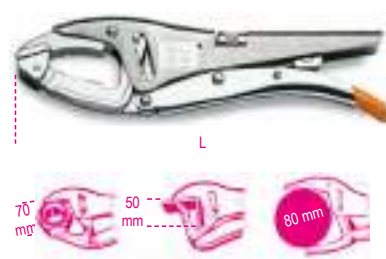

L mm	€	🔧	📦
255	101,00	2	010510250

1051L

alicate de pressão de grande capacidade com dupla regulação



L mm	€	🔧	📦
270	108,00	2	010510100

1051XL

alicate de pressão de grande capacidade com dupla regulação, mordentes extra-longos



L mm	€	🔧	📦
270	130,00	2	010510140

1052

alicates de pressão, maxilas côncavas



L mm	A1 max mm	€	🔧	📦
140	22	29,00	3	010520014
190	36	32,50	3	010520019
240	42	35,00	3	010520024
300	55	58,50	2	010520030

1053

alicates de pressão, maxila oscilante



L mm	A1 max mm	€	🔧	📦
240	35	49,00	2	010530024

1054

alicate de pressão, maxilas direitas

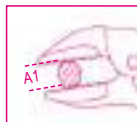

L mm	A1 max mm	€	🔧	📦
235	40	43,00	2	010540022

1055

alicate de pressão, maxilas recurvadas

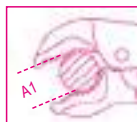

L mm	A1 max mm	€	🔧	📦
270	75	38,50	2	010550027

1055D

alicate de pressão, para porcas e perfis cilíndricos

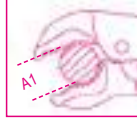

L mm	A1 max mm	€	🔧	📦
195	22	30,00	2	010550119
235	43	33,50	2	010550123

1056

alicate de pressão pescoço de cisne para técnicos de refrigeração

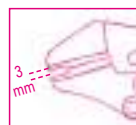

L mm	€	🔧	📦
195	29,50	2	010560017

1057A

alicate ajustável com sistema autoblocante



L mm	€	🔧	📦
240	61,00	2	010570124

1058

alicates de pressão, bicos longos

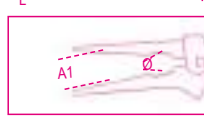

L mm	A1 max mm	Ø max mm	€	🔧	📦
175	34	26	37,00	2	010580017
225	46	31	44,00	2	010580025

1059

alicates de pressão com maxila deslizante

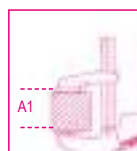

L1 mm	L mm	A1 mm	€	🔧	📦
160	255	120	66,00	1	010590016
270	255	220	69,00	1	010590027

1060

alicate de pressão para soldadura

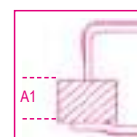

L mm	A1 max mm	€	🔧	📦
200	50	46,50	2	010600020
280	80	59,00	2	010600028

1061

alicate de pressão para soldadura

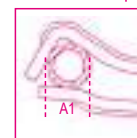

L mm	A1 max mm	€	🔧	📦
275	80	51,00	2	010610027

1062

alicates de pressão pescoço de cisne



L mm	A2 max mm	€	🔧	📦
170	50	36,00	2	010620017
290	120	48,00	2	010620029
460	255	68,50	1	010620045



1062AL

alicate de pressão pescoço de cisne, maxilas em alumínio

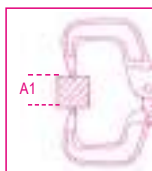

L mm	A1 max mm	€	🔧	📦
275	88	64,00	2	010620327

1062GM

alicate de pressão pescoço de cisne, maxilas oscilantes

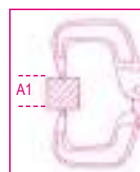

L mm	A1 max mm	€	🔧	📦
170	45	39,50	2	010620217
290	88	56,00	2	010620229
460	255	79,00	1	010620245

1063

alicate de pressão para latoeiros

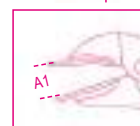

L mm	A1 max mm	€	🔧	📦
200	31	47,00	2	010630021

1064

alicate de pressão com corrente



L mm	Ø mm	€	🔧	📦
230	150	67,50	2	010640023

1065F

alicate de furar chapa

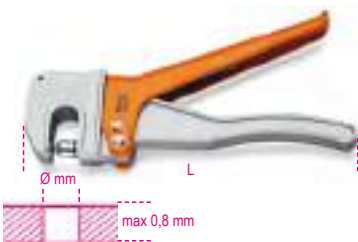

Ø mm	L mm	€	🔧	📦
5	228	136,00	1	010650010
6	228	137,00	1	010650015

1065P

alicate de dobrar chapa

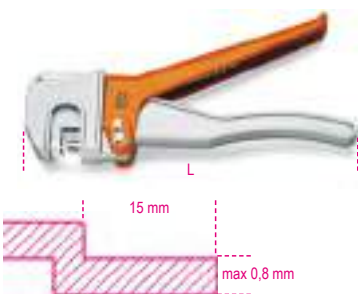

L mm	€	🔧	📦
228	140,00	1	010650020

1066

alicate de pressão, ângulo bloqueável a 90°

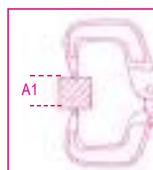

L mm	A1 max mm	g	€	🔧	📦
210	55	500	89,00	1	010660021

1067

alicate de pressão ajustável para tubos, com maxila articulada

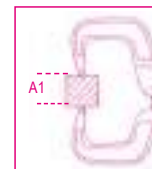

L mm	A1 max mm	€	🔧	📦
285	76	56,50	1	010670285
380	89	58,00	1	010670380

1077

alicate de latoeiro com pontas largas e direitas, punhos com cobertura em PVC



L mm	A mm	L1 mm	€	🔧	📦
280	60	53	58,00	1	010770026

1078

alicate de latoeiro com pontas largas e curvas a 45°, punhos com cobertura em PVC



L mm	A mm	L1 mm	€	🔧	📦
280	60	77	59,00	1	010780026

1080D

alicate de corte diagonal raso com punhos com revestimento duplo em PVC

Para corte de plástico



α	L mm	L1 mm	€	🔧	📦
15°	160	22	31,00	3	010800015
45°	160	22	37,50	3	010800045

1081

Alicate de corte, punho anti-derrapante com revestimento duplo em PVC

• Para eletrônica e trabalhos pesados em micromecânica



L mm	L1 mm	€	U	U
125	16	32,00	3	010810130

1082

alicates de corte diagonal com punhos de dupla camada em PVC



UNI/ISO 5749

L mm	L1 mm	mm	€	U	U
140	20	1,6	28,00	5	010820004
160	22	1,6	29,00	5	010820006

1082G

alicate de corte diagonal, punhos com duplo revestimento PVC, acabamento industrial



UNI/ISO 5749

L mm	L1 mm	mm	€	U	U
140	20	1,6	23,90	5	010820064
160	22	1,6	25,00	5	010820066

1082BM

alicates de corte diagonal, punhos bi-material



UNI/ISO 5749

L mm	L1 mm	mm	€	U	U
140	20	1,6	34,50	3	010820034
160	22	1,6	38,00	3	010820036

1082GBM

alicate de corte diagonal, punhos bi-material, acabamento industrial



UNI/ISO 5749

L mm	L1 mm	mm	€	U	U
140	20	1,6	30,50	3	010820264
160	22	1,6	34,00	3	010820266

1084

alicates de corte diagonal para serviços pesados com punhos de dupla camada em PVC



UNI/ISO 5749

L mm	L1 mm	mm	€	U	U
160	22	1,6	32,50	5	010840006
200	28	2,0	40,50	3	010840010

1084G

alicates de corte diagonal para serviços pesados, punhos anti-deslizantes com dupla camada em PVC, acabamento industrial



UNI/ISO 5749

L mm	L1 mm	mm	€	U	U
160	22	1,6	28,50	5	010840066
200	28	2,0	35,00	3	010840070

1084BM

alicates de corte diagonal para serviços pesados punhos bi-material



UNI/ISO 5749

L mm	L1 mm	mm	€	U	U
160	22	1,6	39,50	3	010840036
200	28	2,0	51,00	3	010840040

1084GBM

alicates de corte diagonal para serviços pesados, punhos em bi-matéria, acabamento industrial



UNI/ISO 5749

L mm	L1 mm	mm	€	U	U
160	22	1,6	43,50	3	010840266
200	28	2,0	56,00	3	010840270

1088

alicates de corte frontal para serviços pesados com punhos de dupla camada em PVC



UNI/ISO 5748

L mm	L1 mm	mm	€	U	U
160	9	1,6	40,00	2	010880006
200	11	2,0	52,50	2	010880010

1088BM

alicates de corte frontal para serviços pesados, punhos bi-material



UNI/ISO 5748

L mm	L1 mm	mm	€	U	U
160	9	1,6	48,50	2	010880036
200	11	2,0	67,00	2	010880040



1092V

alicates de corte frontal articulados,
serviço pesado

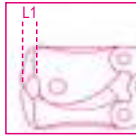

UNI/ISO 5748

L mm	L1 mm	Ø mm	€	U	IT
180	8	2,0	160,00	2	010920280
200	9	2,5	169,00	2	010920310

1094V

alicate de corte diagonal articulados,
serviço pesado



UNI/ISO 5749

L mm	L1 mm	Ø mm	€	U	IT
200	23	2,5	160,00	2	010940200

1095N

alicate de corte diagonal



L mm	L1 mm	Ø mm	€	U	IT
195	26	1,6	56,50	2	010950010

1096

tenazes de carpinteiro



ISO 9243

L mm	L1 mm	€	U	IT
160	21	21,50	5	010960016
200	23	25,00	5	010960020
250	30	33,50	5	010960025

1098

turquês para cofragens



ISO 9242 DIN 5242

L mm	L1 mm	€	U	IT
190	12	21,50	5	010980190
220	13	24,30	5	010980220
250	15	29,00	5	010980250
280	18	32,00	5	010980280

1098PL

turquês para cofragens
punhos revestidos a PVC



ISO 9242 DIN 5242

L mm	L1 mm	€	U	IT
220	13	27,00	5	010980320
250	15	31,00	5	010980350
280	18	34,00	5	010980380

1101

corta-parafusos



L mm	L mm	€	U	IT
300	12	64,00	2	011010030
350	14	78,00	2	011010035
450	18	95,50	1	011010045
600	24	131,00	1	011010060
750	30	169,00	1	011010075
900	36	225,00	1	011010090

L mm	R = 80 Kg/mm² Ø mm	R = 140 Kg/mm² Ø mm	g	IT
300	5	4	745	
350	6	5	1043	
450	7	6	1537	
600	9	7	2540	
750	11	8	3870	
900	12	9	6170	

1101R

lâminas de substituição
para o modelo 1101



mm	1101	€	U	IT
300	300	38,00	1	011010130
350	350	44,00	1	011010135
450	450	56,50	1	011010145
600	600	76,50	1	011010160
750	750	94,50	1	011010175
900	900	125,00	1	011010190

1102

corta-parafusos

R= 80 Kg/mm²



L mm	Ø mm	€	U	IT
230	4	47,00	3	011020020

1103

corta-ferros para hastes, parafusos e redes
eletrosoldadas de reforço de betão

Ø máx. = 12 mm
Ø máx. (HRC 48)= 6 mm



L mm	€	U	IT
950	170,00	1	011030090

1103R

cabeça de substituição para item 1103



1103R 950	€	U	IT
	101,00	1	011030190



1104

corta cabos de aço para serviços pesados, com punhos em material termoplástico



L mm	mm	€		
420	12	164,00	1	011040004
600	16	239,00	1	011040006

1104R

lâminas de substituição para artigo 1104



mm	€		
420	102,00	1	011040014
600	142,00	1	011040016

1105

vazador de juntas



D mm	L mm	€		
2	27	17,30	1	011050002
3	27	17,30	1	011050003
4	27	17,30	1	011050004
5	27	17,30	1	011050005
6	27	17,30	1	011050006
7	27	17,30	1	011050007
8	27	17,30	1	011050008
9	27	17,30	1	011050009
10	27	17,30	1	011050010
12	27	21,20	1	011050012
14	27	21,20	1	011050014
16	27	21,20	1	011050016
18	27	21,20	1	011050018
20	27	21,20	1	011050020
22	32	26,50	1	011050022
24	32	26,50	1	011050024
26	32	26,50	1	011050026
28	32	26,50	1	011050028
30	32	26,50	1	011050030
32	37	34,50	1	011050032
34	37	34,50	1	011050034
36	37	34,50	1	011050036
38	37	34,50	1	011050038
40	37	34,50	1	011050040
42	42	40,50	1	011050042
44	42	40,50	1	011050044
46	42	40,50	1	011050046
48	42	40,50	1	011050048
50	42	40,50	1	011050050

1105T20

adaptador para punções 1105, 2 a 20 mm



L mm	€		
110	86,00	1	011050200

1105T30

adaptador para punções 1105, 3 a 30 mm



L mm	€		
175	185,00	1	011050205

1105T50

adaptador para punções 1105 2 a 50 mm



L mm	€		
175	183,00	1	011050207

1105AD-50

adaptador para ref. 1105T50



Ø mm	€		
57	115,00	1	011050210

1105/C10T

sortido de 10 punções, 3 a 20 mm, e 1 acessório



1105C/10T	€		
	192,00	1	011050250

	1105	3 - 4 - 6 - 8 - 10 - 12 - 14 - 16 - 18 - 20 mm

1105T20

135x92x32 mm

1105/C16T

sortido de 15 punções, 3 a 30 mm, e 1 acessório



1105C/16T	€		
	346,00	1	011050255

	1105	3 - 4 - 6 - 8 - 10 - 12 - 14 - 16 - 18 - 20 - 22 - 24 - 26 - 28 - 30 mm

1105T30

240x210x60 mm

1105/C32T

sortido de 29 punções, 2 a 50 mm, e 3 acessórios



1105C/32T	€		
	675,00	1	011050257

	1105	2 - 3 - 4 - 5 - 6 - 7 - 8 - 9 - 10 - 12 - 14 - 16 - 18 - 20 - 22 - 24 - 26 - 28 - 30 - 32 - 34 - 36 - 38 - 40 - 42 - 44 - 46 - 48 - 50 mm

1105T50

1105AD-50

455x380x115 mm

1112

tesoura modelo americano lâminas largas e direitas

R= 60 Kg/mm²



L ~	L1 mm	S mm	A mm	€		
200	50	0,5	26	28,50	2	011120020
250	62	0,8	33	34,00	2	011120025
300	76	1,0	37	44,00	2	011120030
375	76	1,2	44	65,00	1	011120037

1114

tesoura de lâminas estreitas e direitas para metal mole

R = 60 Kgf/mm²



L	L1	S	A	€		
mm	mm	mm	mm			
250	58	0,5	15	30,50	1	011140265
350	76	1	22	40,00	1	011140340

1118

tesoura para cintas de embalagem

Fe = aço normal

Inox = aço inoxidável



L	L1	Fe	Inox	€		
mm	mm	S mm	S mm			
310	42	1	0,8	49,50	2	011180001

1120A

tesoura para cortar metal

Fe = aço macio



L	Fe	€		
mm	S mm			
280	1,2	80,00	1	011200101

1120ARL - ARG

peças de substituição para artigo 1120A



	€		
1120ARL	19,90	1	011200110
1120ARG	25,00	1	011200120

1122

tesoura articulada lâminas direitas

Inox = aço inoxidável



L	L1	Inox	A	€		
mm	mm	S mm	mm			
250	40	1	24	38,50	2	011220020

1123

tesoura articulada de lâminas curvas para contornos a direita

Inox = aço inoxidável



L	L1	Inox	A	€		
mm	mm	S mm	mm			
250	40	1	24	38,50	2	011230020

1124

tesoura articulada de lâminas curvas para contornos a esquerda

Inox = aço inoxidável



L	L1	Inox	A	€		
mm	mm	S mm	mm			
250	40	1	24	38,50	2	011240020

1125

tesoura articulada para cortes rectilíneos e contornos a direita

Inox = aço inoxidável



L	L1	Inox	A	€		
mm	mm	S mm	mm			
250	35	1	46	60,00	2	011250020

1126

tesoura articulada para cortes rectilíneos e contornos a esquerda

Inox = aço inoxidável



L	L1	Inox	A	€		
mm	mm	S mm	mm			
250	35	1	46	60,00	2	011260020

1122 - 1125MOL



	€		
1122 MOL 1122 - 1124	1,71	1	011220010
1123 MOL 1123	1,45	1	011230010
1125 MOL 1125 - 1126	1,45	1	011250040

1127

tesouras para técnico de telefones lâminas direitas



L	L1	€		
mm	mm			
150	35	16,70	5	011270001

1128BAX

Tesoura de electricista com perfis de escareação graduados, lâminas em aço inox com revestimento DLC

Gumes de corte duplo: pino excêntrico especial permite que as lâminas se movimentem a todo o comprimento, aumentando a eficiência de corte.

Concebida para alargar furos em plástico, de 13 mm a 25 mm.

Revestimento DLC (diamond-like carbon) é um revestimento inovador à base de carbono: a elevada dureza e baixo atrito resultam da combinação de carbono, sob a forma de grafite, e diamante.

- Elevada dureza da superfície da lâmina (resistência à abrasão e desgaste)
- Baixa fricção (suavidade e antiaderência)
- Pino excêntrico especial
- Punhos de grandes dimensões com ranhura para corte de cabos e cravagem de terminais
- Com caixa em plástico articulada



L	L1		€		
mm	mm	mm ²			
150	50	50	37,00	5	011280088

1128BMX

tesoura para electricistas, lâminas direitas em aço inoxidável, com micro-dentes



L	L1	€		
mm	mm			
147	58,2	19,60	5	011280051

1128BMX/F

estoujo em plástico articulado para item 1128BMX



	€		
1128BMX/F	1,97	1	011280059

1128FXS TESOURA DE ELETRICISTA COM PERFIS DE ESCAREAÇÃO GRADUADOS

Para reformular a nossa tesoura de electricista observámos o trabalho diário dos utilizadores. Transformámo-la numa ferramenta universal, incorporando as 4 principais características num único utensílio.

CORTAR Rapidez e afiação, para cabos até 50 mm², com uma ranhura para corte de cabos e lâmina micro dentada, para uma retenção melhorada.

DESCARNAR O pino anti-folga permite descarnar de forma precisa até os cabos mais finos.

CRAVAR Com segurança e resistência, para terminais de tubos

ESCAREAR O perfil de escareação exclusivo permite alargar furos em plástico de forma precisa e limpa.



1128BAX TESOURA DE ELETRICISTA COM PERFIS DE ESCAREAÇÃO GRADUADOS LÂMINAS EM AÇO INOX COM REVESTIMENTO DLC

As tesouras 1128BAX destacam-se pelas suas lâminas com revestimento DLC (diamond-like carbon

Trata-se de um inovador revestimento à base de carbono: a elevada dureza e baixo atrito resultam da combinação de diamante e carbono, sob a forma de grafite.

- Elevada dureza da superfície da lâmina - resistência à abrasão e desgaste
- Baixa fricção - suavidade e anti-aderência

Perfil de corte: concebida para alargar furos em plástico, de 13 mm a 25 mm.



+ DUREZA
- COEFICIENTE DE FRICÇÃO

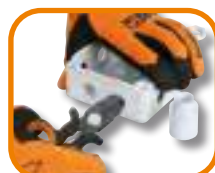

1128BSX

tesoura de electricista com perfis de escareação graduados, em caixa



L mm	L1 mm	€	5	011280061
148	58,2	33,50		

1128FX

tesoura de electricista, lâminas direitas em aço inox, com micro-dentado, ranhura para corte de cabos e alicate para cravagem de terminais

- Bolsa para cinto
- Punhos bi-material
- Pino de regulação de folga



L mm	L1 mm	mm ²	€	5	011280090
145	52	50	35,50		

1128FXS

tesoura de electricista com perfis de escareação graduados, lâminas direitas em aço inox, com micro-dentado, ranhura para corte de cabos e alicate para cravagem de terminais

- Bolsa para cinto
- Punhos bi-material
- Pino de regulação de folga

• Concebida para alargar furos em plástico de 13 a 21 mm.



L mm	L1 mm	mm ²	€	5	011280095
145	52	50	42,50		

1128BM

tesouras de lâminas direitas para electricistas



L mm	L1 mm	€	5	011280000
145	50	17,00		

1129BM

tesouras de lâminas curvas para electricistas



L mm	L1 mm	€	5	011290000
145	44	18,10		

1130BMX

tesoura multiusos, lâminas direitas em aço inox, com micro-dentado



L mm	L1 mm	€	1	011300002
185	60	22,00		

1131CK

tesoura para Kevlar® e fibra óptica



L mm	L1 mm	€	1	011310001
203	75	88,00		

1132

corta-cabos para cabos isolados de cobre e alumínio com punhos de dupla camada em PVC



UNI 8791

L	mm	mm ²	€	Unid.	Imagem
170	14	50	54,50	2	011320107
230	18	95	67,00	2	011320113

1132BM

corta-cabos para cabos isolados de cobre e alumínio com punhos bi-material



UNI 8791

L	mm	mm ²	€	Unid.	Imagem
170	14	50	67,00	2	011320137
230	18	95	82,00	2	011320143

1133

corta-cabos para cabos em cobre, flexível

até 325 mm²



L	mm	mm ²	€	Unid.	Imagem
600	30	325	186,00	1	011330001

1133RL

lâminas de substituição para artigo 1133



1133RL	€	Unid.	Imagem
	140,00	1	011330011

1134

corta-cabos com roquete



L	mm	mm ²	mm ²	€	Unid.	Imagem
260	35	400		545,00	1	011340032

1134RL

lâmina de substituição para o modelo 1134



1134RL	€	Unid.	Imagem
	246,00	1	011340132

1134A

corta-cabos com roquete



L	mm	mm ²	mm ²	€	Unid.	Imagem
240	45	500		825,00	1	011340045

1142BM

alicate para descarnar fio punhos bi-material



UNI 7923

L	mm	mm ²	mm	€	Unid.	Imagem
160		0,5÷6	0-2,8	44,00	3	011420036

1143

alicates para descarnar fio com dispositivo de corte



L	mm	mm ²	mm	€	Unid.	Imagem
165		0,5÷6	1-3,2	86,50	1	011430001

1143R

lâminas de substituição para artigo 1143

1143R	€	Unid.	Imagem
	21,90	1	011430011

1144D

alicate para descarnar cabo



L	mm	mm ²	mm	€	Unid.	Imagem
170		4,5÷240	2,5-18	104,00	1	011440010

1144D/RG

gancho de substituição para artigo 1144D



1144D/RG	€	Unid.	Imagem
	34,50	1	011440012

1144D/RL

laminas de substituição para artigo 1144D

1144D/RL	€	Unid.	Imagem
	53,50	1	011440011

1144G

alicate para descarnar cabo

com lâmina ajustável para cortes longitudinais e transversais



L	mm	mm ²	mm	€	Unid.	Imagem
140		6÷75	2,8-12	58,00	1	011440004



Beta

1144G/RL

lâmina sobresselente para artigo 1144G



1144G/RL	€	1	011440005
	12,90		

1144L

Ferramenta para descarnar, com profundidade de lâmina ajustável, para cortes longitudinais e transversais
com lâmina retrátil, suave e em forma de gancho



L			€	1	011440050
145	6-150	4-28	33,50		

1144T

ferramenta de descarnar, tamanho de bolso, com cortante



L			€	1	011440060
112	3,5 ÷ 9	40	23,30		

1148A

alicates para descarnar fio, com ajuste e dispositivo de corte

10 mm² (8 AWG) fios flexíveis
1,5 mm² (16 AWG) fios rígidos



L			€	1	011480100
190	0,02 ÷ 10	0-4	178,00		

1148A/R

lâminas para artigo 1148A



1148A/R	€	1	011480102
	76,50		

Beta

1148B

alicates para descarnar fio, com ajuste e dispositivo de corte



L			€	1	011480200
190	4 ÷ 16	2-5	209,00		

1148B/R

lâminas de substituição para artigo 1148B



1148B/R	€	1	011480202
	95,50		

1148P

Alicate de descarnar cabo, auto-ajustável, com cortante



L			€	1	011480300
165	0,2-6	0-3,5	49,50		

1149F

alicate frontal de descarnar fio com lâmina de corte, com fecho automático



L		€	1	011490010
175	0,2 ÷ 6	19,30		

1150

alicates universais em cromado brilhante com punhos de dupla camada de PVC

• O encaixe descentrado aumenta a alavancagem, reduzindo o esforço, para uma poderosa capacidade de corte.



ISO 5746

L	L1		€	5	011500046
160	42	1,6	24,70		
180	46	1,8	27,00		
200	50	2,0	29,00		
220	50	2,0	32,00		

1150G

alicate combinado para trabalhos pesados, punhos com duplo revestimento PVC, acabamento industrial

• Excelente relação qualidade/preço
• O encaixe descentrado aumenta a alavancagem, reduzindo o esforço, para uma capacidade de corte poderosa.



ISO 5746

L	L1		€	5	011500066
160	42	1,6	23,00		
180	46	1,8	25,00		
200	50	2,0	28,00		
220	50	2,0	29,00		

Beta

1150HPC ALICATE UNIVERSAL HYPERCUT COM ARESTAS EM AÇO SINTERIZADO M2

- O pino descentralizado permite que o ponto de apoio fique mais próximo do ponto de corte, resultando num efeito de alavanca melhorado.
- As pontas perfeitamente alinhadas e o perfil fino garantem um aperto firme em qualquer espaço, inclusive em áreas extremamente reduzidas.
- Corpo do alicate em aço de molibdénio fiável, com tratamento térmico para garantir flexibilidade e resistência, bem como um aperto firme em qualquer condição.

PATENTEADO

Tensão de corte – teste estático =	-73%
Vida média das arestas de corte = (teste ISO 5744)	+127%
Dureza das arestas de corte em aço M2 =	65HRC

ABSOLUTAMENTE INOVADOR

ACABAMENTO CROMADO PÉROLA

NOTÁVEL CAPACIDADE DE CORTE

1150HPC

alicate universal para serviços pesados com insert de corte e veio descentralizado
acabamento acetinado cromado
punho bimatéria

insert de corte
aço: M2
espessura: 0.20 mm
ângulo: 62°
dureza: 63+65 HRC



ISO 5746

L mm	L1 mm	mm	€	U	U
180	42	1,8	67,50	2	011500618

1150BM

alicates universais em cromado brilhante com punhos bi-material

- O encaixe descentrado aumenta a alavancagem, reduzindo o esforço, para uma poderosa capacidade de corte.



ISO 5746

L mm	L1 mm	mm	€	U	U
160	42	1,6	30,50	3	011500146
180	46	1,8	33,50	3	011500148
200	50	2,0	37,00	3	011500150
220	50	2,0	39,50	2	011500152

1150GBM

alicate combinado para trabalhos pesados, punhos bi-material, acabamento industrial

- O encaixe descentrado aumenta a alavancagem, reduzindo o esforço, para uma poderosa capacidade de corte.
- Excelente relação qualidade/preço



ISO 5746

L mm	L1 mm	mm	€	U	U
160	42	1,6	28,50	3	011500266
180	39	1,8	30,50	3	011500268
200	50	2,0	34,50	3	011500270
220	50	2,0	37,00	2	011500272

1153

alicates reguláveis com duas posições e punhos em PVC



UNI ISO 9343

L mm	L1 mm	€	U	U
200	34	28,00	2	011530120

1162

alicates de pontas chatas extra-longas com estrias e punhos de dupla camada em PVC



ISO 5745

L mm	L1 mm	mm	€	U	U
160	58	1,6	29,00	5	011620006
200	86	1,6	33,50	5	011620010



1162G

alicates de pontas chatas extra longas, com estrias, punhos anti-deslizantes com dupla camada de PVC, acabamento industrial

• Excelente relação qualidade/preço

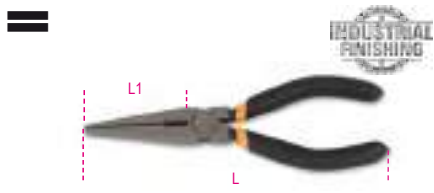

ISO 5745

L mm	L1 mm	mm	€	Hand	ISO
160	58	1,6	24,70	5	011620066
200	86	1,6	28,50	5	011620070

1162BM

alicates de pontas chatas extra-longas com estrias punhos bi-material



ISO 5745

L mm	L1 mm	mm	€	Hand	ISO
160	58	1,6	35,00	3	011620036
200	86	1,6	39,50	3	011620040

1162GBM

alicate de pontas chatas extra longas, com estrias, punhos em bi-matéria, acabamento industrial

• Excelente relação qualidade/preço



ISO 5745

L mm	L1 mm	mm	€	Hand	ISO
160	58	1,6	30,50	3	011620266
200	86	1,6	35,50	3	011620270

1164

alicates de pontas curvas chatas com estrias, extra-longas, e punhos de dupla camada de PVC



ISO 5745

L mm	L1 mm	mm	€	Hand	ISO
160	54	1,6	31,50	5	011640006
200	76	1,6	35,00	5	011640010

1164BM

alicates de pontas curvas chatas com estrias, extra-longas, e punhos de dupla camada de PVC



ISO 5745

L mm	L1 mm	mm	€	Hand	ISO
160	54	1,6	38,50	3	011640036
200	76	1,6	43,50	3	011640040

1166

alicates de pontas semi-redondas com estrias, extra-longas, e punhos de dupla camada de PVC



ISO 5745

L mm	L1 mm	mm	€	Hand	ISO
160	56	1,6	29,00	5	011660006
200	76	1,6	33,50	5	011660010

1166G

alicate de ponta semi-redondas com estrias, extra-longas, punhos com duplo revestimento PVC, acabamento industrial

• Excelente relação qualidade/preço

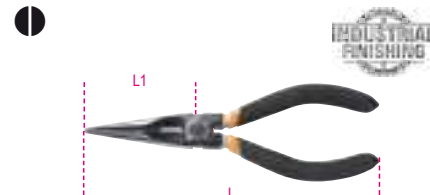

ISO 5745

L mm	L1 mm	mm	€	Hand	ISO
160	56	1,6	24,70	5	011660066
200	76	1,6	28,50	5	011660070

1166BM

alicates de pontas semi-redondas com estrias, extra-longas, e punhos bi-material



ISO 5745

L mm	L1 mm	mm	€	Hand	ISO
160	56	1,6	35,00	3	011660036
200	76	1,6	39,50	3	011660040

1166GBM

alicate de pontas semi-redondas com estrias, extra-longas, punhos bi-material, acabamento industrial

• Excelente relação qualidade/preço



ISO 5745

L mm	L1 mm	mm	€	Hand	ISO
160	56	1,6	30,50	3	011660266
200	76	1,6	35,50	3	011660270

1168

alicates de pontas curvas semi-redondas com estrias, extra-longas, e punhos de dupla camada de PVC



ISO 5745

L mm	L1 mm	mm	€	Hand	ISO
160	54	1,6	31,50	5	011680006
200	76	1,6	35,00	5	011680010

1168G

alicates de pontas curvas extra longas, com estrias, punhos anti-deslizantes com dupla camada de PVC, acabamento industrial

• Excelente relação qualidade/preço



ISO 5745

L mm	L1 mm	mm	€	Hand	ISO
160	54	1,6	27,00	5	011680066
200	76	1,6	30,50	5	011680070

1168BM

alicates de pontas curvas semi-redondas com estrias, extra-longas, e punhos bi-material



ISO 5745

L mm	L1 mm	mm	€	3	011680036
160	54	1,6	38,50	3	011680036
200	70	1,6	43,50	3	011680040

1168GBM

alicates de pontas curvas extra longas, punhos em bi-matéria, acabamento industrial

• Excelente relação qualidade/preço



ISO 5745

L mm	L1 mm	mm	€	3	011680266
160	54	1,6	34,00	3	011680266
200	70	1,6	38,50	3	011680270

1169/D3

jogo de 1 alicate universal, 1 alicate de pontas longas e 1 alicate de corte diagonal



1169/D3	€	1	011690053
1082 160mm	85,00	1	011690053
1150 180mm			
1166 160mm			

1169G/D3

Conjunto de 1 alicate universal, 1 alicate de pontas semi-redondas longas e 1 alicate de corte, punhos em dupla camada de PVC anti-derrapante, acabamento industrial.

• Excelente relação qualidade/preço



1169G/D3	€	1	011690073
1082G 160mm	75,00	1	011690073
1150G 180mm			
1166G 160mm			

1169BM/D3

jogo de 1 alicate universal, 1 alicate de pontas redondas longas e 1 alicate de corte diagonal Punhos bi-material



1169BM/D3	€	1	011690133
1082BM 160mm	107,00	1	011690133
1150BM 180mm			
1166BM 160mm			

1169GBM/D3

Conjunto de 1 alicate universal, 1 alicate de pontas semi-redondas longas e 1 alicate de corte, punhos bi-material, acabamento industrial.

• Excelente relação qualidade/preço



1169GBM/D3	€	1	011690273
1082GBM 160mm	95,50	1	011690273
1150GBM 180mm			
1166GBM 160mm			

1169N/D4

jogo de 1 alicate combinado para trabalhos pesados, 1 alicate de pontas longas, 1 alicate de corte cromado e 1 and 1 alicate ajustável de charneira fechada, fosfatado



1169N/D4	€	1	011690024
1082 160 mm	116,00	1	011690024
1150 180 mm			
1166 160 mm			
1048N 250 mm			

1171BM

alicate de pontas chatas curtas, brunido punhos bi-material



ISO 9655

L	L1 mm	A mm	B mm	€	2	011710101
130	18	12	8	48,00	2	011710101

1172BM

alicate de pontas chatas longas, brunido punhos bi-material

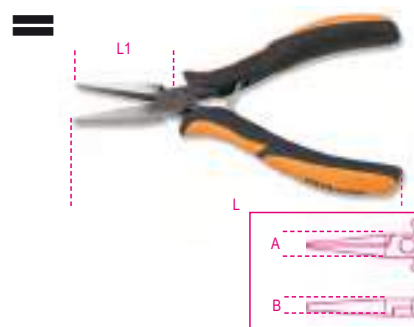

ISO 9655

L	L1 mm	A mm	B mm	€	2	011720101
140	40	12	8	48,00	2	011720101

Beta

1172BM/P

alicate de pontas chatas curvas, brunido
punhos bi-material

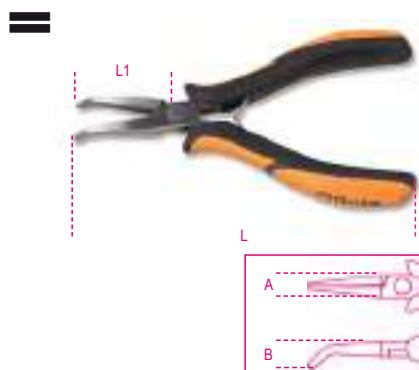

L	L1	A	B	€	🔧	📄
140	38	12	13	55,50	2	011720102

1173BM

alicate de pontas redondas curtas, punhos bi-material

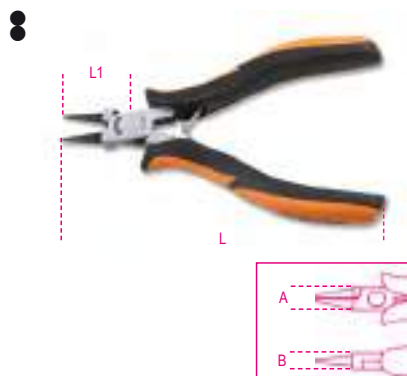

ISO 9655

L	L1	A	B	€	🔧	📄
125	22	12	8	48,00	2	011730101

1175BM

alicate de pontas semi-redondas curtas, brunido
punhos bi-material



ISO 9655

L	L1	A	B	€	🔧	📄
140	29	12	8	48,00	2	011750101

1177BM

alicate de pontas semi-redondas longas, brunido
punhos bi-material

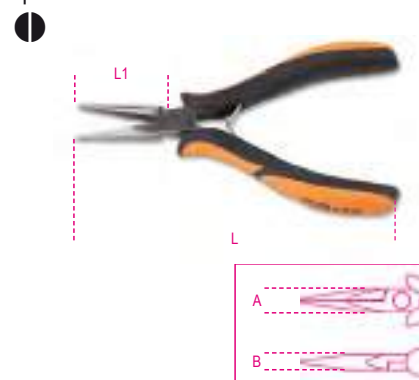

ISO 9655

L	L1	A	B	€	🔧	📄
140	38	12	8	48,00	2	011770101

1177BM/Z

alicate de pontas semi-redondas longas com estrias
punhos bi-material

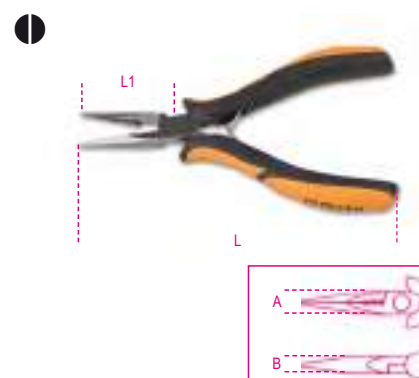

ISO 9655

L	L1	A	B	€	🔧	📄
140	39	12	8	55,50	2	011770113

1178BM

alicate de pontas semi redondas longas, brunido
punhos bi-material

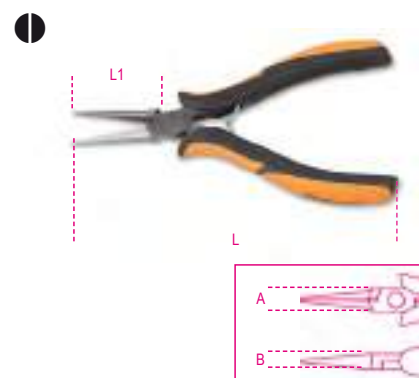

ISO 9655

L	L1	A	B	€	🔧	📄
140	37	12	8	55,50	2	011780101

1178BM/P

alicate de pontas semi-redondas longas curvas, brunido
punhos bi-material

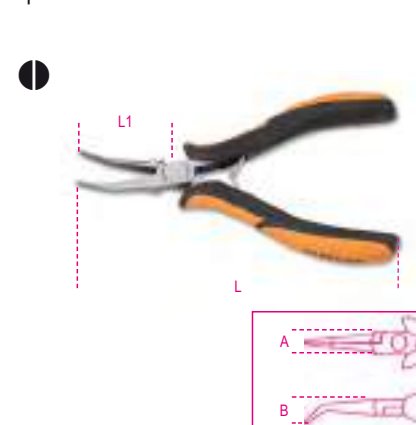

L	L1	A	B	€	🔧	📄
140	36,5	12	12	55,50	2	011780102

Alicate de corte diagonal, semi-raso pontas finas, punhos bi-material
Para trabalhos mais fortes, ver item 1081

1182BM

alicate de corte diagonal, semi-raso pontas finas
punhos bi-material



ISO 9654

L	L1	A	Cu	€	🔧	📄
mm	mm	mm	mm			
120	11	10	1	55,50	2	011820101



1183BM

alicate de corte diagonal, semi-raso
pontas arredondadas
punhos bi-material



ISO 9654

L mm	L1 mm	A mm	Cu mm	€	QTY	Part No.
120	11	10	1	55,50	2	011830101
130	13	12,5	1,25	55,50	2	011830102

1184BM

alicate de corte diagonal, raso
pontas arredondadas
punhos bi-material



ISO 9654

L mm	L1 mm	A mm	Cu mm	€	QTY	Part No.
120	11	10	1	55,50	2	011840101
130	13	12,5	1,25	55,50	2	011840102

1185BM

alicate de corte diagonal, raso
pontas finas
punhos bi-material

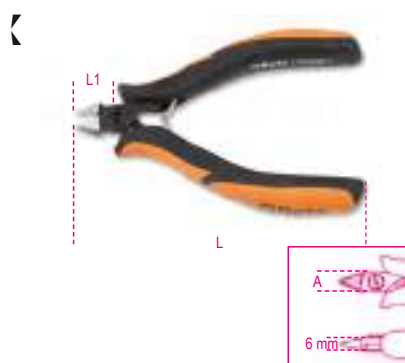

ISO 9654

L mm	L1 mm	A mm	Cu mm	€	QTY	Part No.
120	11	10	1	55,50	2	011850101
130	13	12,5	1,25	55,50	2	011850102

1186BM

alicate de corte diagonal, raso,
pontas finas e estritas
punhos bi-material



ISO 9654

L mm	L1 mm	A mm	Cu mm	€	QTY	Part No.
120	11	10	1	55,50	2	011860101
130	13	12,5	1,25	55,50	2	011860102

1188BM

alicate de corte diagonal normal
punhos bi-material



ISO 9654

L mm	L1 mm	A mm	Cu mm	€	QTY	Part No.
125	12	12	1,25	55,50	2	011880101
130	17	15	2	55,50	2	011880102

1190BM

alicate de corte frontal, semi raso
punhos bi-material



ISO 9654

L mm	L1 mm	A mm	Cu mm	€	QTY	Part No.
120	12	12	1,25	55,50	2	011900113

1191BM

alicate de corte frontal oblíquo, raso
punhos bi-material



ISO 9654

L mm	L1 mm	A mm	Cu mm	€	QTY	Part No.
130	8	12	0,8	55,50	2	011910101

1191BM/L

alicate de corte frontal oblíquo longo, raso
punhos bi-material



ISO 9654

L mm	L1 mm	A mm	Cu mm	€	QTY	Part No.
130	18	12	1	55,50	2	011910110

1191R/5-M

kit de molas de substituição para alicates e
pinças
para componentes eletrônicos, 5 pares
(artigos: 1171...1191)

1191R/5-M	€	QTY	Part No.
	10,90	1	011910995

1200MS

magnetizador/desmagnetizador

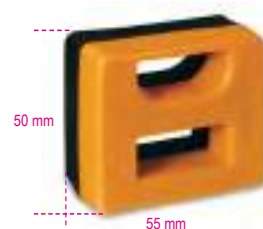

1200MS	€	QTY	Part No.
	17,30	5	012000000

A EVOLUÇÃO DA CHAVE DE FENDAS!

O desenho ergonómico adapta-se perfeitamente à palma da mão. A grande superfície de contacto permite transmitir a máxima força com esforço mínimo.

As hastes testadas da Beta garantem uma elasticidade, dureza e resistência ao desgaste únicas, para ferramentas profissionais topo de gama.

A secção octogonal impede que a chave role na bancada de trabalho.

A área de precisão permite que a chave de fendas seja rapidamente rodada entre os dedos.

O furo no cabo permite que a chave de fendas seja pendurada para fácil armazenamento.

A nova borracha termoplástica torna cada utilização - mesmo em trabalhos pesados - ainda mais confortável.

A forma e o tamanho da ponta são impressos no cabo para uma identificação rápida.

● As hastes testadas da Beta garantem uma elasticidade, dureza e resistência ao desgaste únicas, para ferramentas profissionais topo de gama.

● O desenho ergonómico adapta-se perfeitamente à palma da mão. A grande superfície de contacto permite transmitir a máxima força com esforço mínimo.

● A secção octogonal impede que a chave role na bancada de trabalho.

● A nova borracha termoplástica torna cada utilização - mesmo em trabalhos pesados - ainda mais confortável.

● O furo no cabo permite que a chave de fendas seja pendurada para fácil armazenamento.



● A forma e o tamanho da ponta são impressos no cabo para uma identificação rápida.

● A área de precisão permite que a chave de fendas seja rapidamente rodada entre os dedos.



1201E

chaves para parafusos de perfil de fenda



ISO 2380

SxAxL mm	L1 mm	Ø mm	€	👤	📦
0,4x2,5x50	146	2,5	4,30	5	012011003
0,4x2,5x75	166	2,5	4,45	5	012011006
0,5x3x75	171	3,0	4,50	5	012011009
0,5x3x100	196	3,0	4,85	5	012011012
0,6x3,5x75	171	3,5	4,85	5	012011018
0,6x3,5x100	196	3,5	4,95	5	012011021
0,8x4x100	196	4,0	5,10	5	012011030
0,8x4x125	221	4,0	5,40	5	012011033
0,8x4x150	246	4,0	5,80	5	012011036
1,0x5,5x100	209	5,0	6,40	5	012011039
1,0x5,5x125	234	5,0	6,70	5	012011040
1,0x5,5x150	259	5,0	6,80	5	012011042
1,2x6,5x100	220	6,0	7,50	5	012011048
1,2x6,5x125	234	6,0	7,80	5	012011050
1,2x6,5x150	270	6,0	8,00	5	012011051
1,2x8x150	282	8,0	10,20	3	012011057
1,2x8x200	332	8,0	11,00	3	012011060
1,6x10x200	332	9,5	12,80	3	012011066



1201E/S6	€	👤	📦
0,5x3x75-0,6x3,5x100 0,8x4x100-1,0x5,5x100 1,2x8x150-1,6x10x200 mm	43,50	1	012011206

1201EN

chave para parafusos de perfil de fenda, série extra curta



ISO 2380

SxAxL mm	L1 mm	Ø mm	€	👤	📦
0,8x4x30	86,5	4	6,20	3	012011103
1,2x6,5x30	86,5	6	6,60	3	012011106

1201E/DZ

chave para parafusos de perfil Dzus®



L mm	L1 mm	€	🔧	📦
53	173	16,10	2	012011501

1202E

chave para parafusos de perfil Phillips®



UNI-ISO 8764

PhxDxL mm	L1 mm	€	🔧	📦
0x3x60	156	4,45	5	012021003
0x3x100	200	4,95	5	012021006
1x4,5x80	189	5,70	5	012021009
1x4,5x120	229	6,50	5	012021012
2x6x100	220	7,80	5	012021018
2x6x150	270	8,40	5	012021021
3x8x150	282	10,70	3	012021024
4x9,5x200	332	14,00	3	012021027



	€	🔧	📦
1202E/S4 PH0x3x60-PH1x4,5x120 PH2x6x150-PH3x8x150 mm	30,00	1	012021204

1202EN

chave para parafusos de perfil Phillips®, série extra curta



UNI-ISO 8764

PhxDxL mm	L1 mm	€	🔧	📦
1x4,5x30	86,5	6,20	3	012021103
2x6x30	86,5	6,60	3	012021106

1202EL

chave para parafusos de perfil Phillips®, série longa



UNI-ISO 8764-1

PhxDxL mm	L1 mm	€	🔧	📦
0x3x300	400	8,00	3	012021303
1x4,5x300	400	8,70	3	012021305
1x4,5x400	508	10,60	3	012021306
2x6x400	519	12,20	3	012021309

1203E/D

conjunto de chaves de parafuso



	€	🔧	📦
1203E/D5 1201E 0,6x3,5x100-1,0x5,5x150 1,2x6,5x150 mm 1202E PH1x4,5x80-PH2x6x100 mm	33,00	1	012031001

	€	🔧	📦
1203E/D5PZ 1201E 0,5x3x75-0,8x4x125 1,0x5,5x150 mm 1209E/PZ PZ1x4,5x80-PZ2x6x100 mm	32,00	1	012031003

	€	🔧	📦
1203E/D6 1202E PH1x4,5x80-PH2x6x100 mm 1204E 0,4x2,5x60-0,5x3x100 0,8x4x100-1,0x5x125 mm	34,00	1	012031006

	€	🔧	📦
1203E/D7 1201E 0,5x3x75-0,8x4x100 1,0x5,5x100-1,2x6,5x150 mm 1202E PH0x3x60-PH1x4,5x80 PH2x6x100 mm	41,50	1	012031007

	€	🔧	📦
1203E/D8 1201E 0,5x3x75-0,8x4x125 1,0x5,5x150-1,2x6,5x150 mm 1202E PH0x3x60-PH1x4,5x80 PH2x6x100-PH3x8x150 mm	53,00	1	012031008

	€	🔧	📦
1203E/D8P 1201E 2,5x50-3x75-4x100 5,5x100-6,5x150 mm 1202E PH0x60-PH1x80-PH2x100 mm	46,00	1	012031018

	€	🔧	📦
1203E/D10 1201E 0,4x2,5x50-0,5x3x75 0,8x4x100-1,0x5,5x100 1,2x6,5x150-1,2x8x150 mm 1202E PH0x3x60-PH1x4,5x80 PH2x6x100-PH3x8x150 mm	67,00	1	012031010

	€	🔧	📦
1203E/D10N 1201E 0,4x2,5x50-0,5x3x75-0,8x4x100- 1,0x5,5x150-1,2x6,5x150 mm 1201EN 0,8x4x30 mm 1202E PH0x3x60 - PH1x4,5x80 - PH2x6x100 mm 1202EN PH1x4,5x30 mm	58,50	1	012031019

1203E/S



	€	🔧	📦
1203E/S8 1201E 2,5x50-3x75-4x100 5,5x125-6,5x150 mm 1202E PH0x3x60-PH1x4,5x80 PH2x6x100 mm	46,00	1	012031009

	€	🔧	📦
1203E/S10 1201E 0,4x2,5x50-0,5x3x75 0,8x4x125-1,0x5,5x150 1,2x6,5x150-1,2x8x150 mm 1202E PH0x3x60-PH1x4,5x80 PH2x6x100-PH3x8x150 mm	67,50	1	012031021

1204E

chave para parafusos de perfil de fenda sem cabeça



ISO 2380

SxDxL mm	L1 mm	€	🔧	📦
0,4x2,5x60	156	4,40	5	012041003
0,6x3x75	175	4,50	5	012041006
0,5x3x100	196	4,60	5	012041009
0,8x4x100	196	5,20	5	012041012
0,8x4x125	233	5,50	5	012041015
1x5x125	234	6,40	5	012041018
1x5x150	258	6,90	5	012041021
1,2x6,5x150	270	7,50	5	012041024



	€	🔧	📦
1204E/S5 0,4x2,5x60-0,5x3x100 0,8x4x100-1x5x125 1,2x6,5x150 mm	28,00	1	012041205

1204EL

chave para parafusos de perfil de fenda sem cabeça, série longa



ISO 2380

SxDxL mm	L1 mm	€	📦	📄
0,5x2,5x200	300	6,60	3	012041303
0,5x3x300	400	7,80	3	012041306
0,8x4x400	508	9,60	3	012041309
1x5x400	508	10,20	3	012041315
1,2x6,5x400	519	13,10	3	012041318

1205E/ES

chaves sextavadas com punho



mm	L mm	L1 mm	€	📦	📄
1,5	100	200	5,60	3	012051315
2	100	200	5,70	3	012051320
2,5	100	200	5,80	3	012051325
3	100	200	6,00	3	012051330
4	100	208	6,90	3	012051340
5	100	219	8,20	3	012051350
6	125	244	8,40	3	012051360
8	150	277	11,20	2	012051380



1205E/ES-S8
1,5-2-2,5-3-4-5-6-8 mm

1206E/BP

chaves sextavadas macho com extremidade esférica e punho



mm	L mm	L1 mm	Ø mm	€	📦	📄
2	100	198	2,5	6,30	3	012061320
2,5	100	198	3,0	6,40	3	012061325
3	100	198	3,5	6,50	3	012061330
4	100	209	5,0	7,20	3	012061340
5	100	220	6,0	8,70	3	012061350
6	125	245	7,0	8,90	3	012061360
8	150	287	9,5	11,90	2	012061380



1206E/BP-S7
2-2,5-3-4-5-6-8 mm

1207E/TX

chaves para parafusos de perfil Torx®, com punho



	L mm	L1 mm	Ø mm	€	📦	📄
T5	50	150	3	6,70	5	012071005
T6	60	156	4	7,10	5	012071006
T7	60	156	4	7,20	5	012071007
T8	60	156	4	7,30	5	012071008
T9	60	156	4	7,70	5	012071009
T10	80	189	5	8,70	5	012071010
T15	80	189	5	8,80	5	012071015
T20	100	209	5	8,90	5	012071020
T25	100	209	5	9,20	5	012071025
T27	100	220	6	9,80	5	012071027
T30	100	220	6	9,90	5	012071030
T40	130	262	7	11,70	2	012071040
T45	130	262	8	12,90	2	012071045



1207E/TX-D7
T6-T8-T10-T15
T20-T25-T30
1207E/TX-S13
T5-T6-T7-T8-T9-T10-T15
T20-T25-T27-T30-T40-T45

1208E/RTX

chaves para parafusos de perfil Tamper Resistant Torx®, com punho



	L mm	L1 mm	Ø mm	€	📦	📄
T9	60	156	4	7,80	5	012081009
T10	80	189	5	8,70	5	012081010
T15	80	189	5	9,20	5	012081015
T20	100	209	5	9,40	5	012081020
T25	100	209	5	9,60	5	012081025
T27	100	220	6	10,40	5	012081027
T30	100	220	6	10,90	5	012081030
T40	130	262	7	13,00	2	012081040



1208E/RTX-D7
T9-T10-T15-T20
T25-T27-T30

1209E/PZ

chave para parafusos de perfil Pozidriv®-Supadriv®



UNI-ISO 8764

PZ	L mm	L1 mm	€	📦	📄
0	60	156	5,20	5	012091000
1	80	189	6,80	5	012091003
2	100	220	8,70	5	012091006
3	150	282	13,30	3	012091009
4	200	327	14,50	3	012091012



1209E/PZ-S4
PZ0-PZ1-PZ2-PZ3

1209EN/PZ

chave para parafusos de perfil Pozidriv®-Supadriv®, série extra curta



ISO 8764

PZ	L mm	L1 mm	€	📦	📄
1	30	87	6,20	3	012091103
2	30	87	6,60	3	012091106

CHAVE DE FENDAS ELÉTRICA BETA EVOX-E

A chave de fendas elétrica Beta Evox-E é ideal para realizar trabalhos de alta precisão com o mínimo esforço e máxima rapidez.

CONFORTÁVEL

Dimensões reduzidas para utilização em espaços pequenos e LEDs frontais para excelente visibilidade do ponto de trabalho.

DESIGN ERGONÓMICO

O punho adapta-se perfeitamente à palma da mão, para um trabalho firme e confortável.

1/4



USB-C

Vida útil da bateria

Bateria de lítio de longa duração de 3,7V 2300mAh, permitindo apertar até 1.000 parafusos com um ciclo de carga.

Está disponível em duas variantes:

- chave de fendas elétrica 1210E/GE com pontas



- chave de fendas elétrica 1211E/GE com pontas isoladas de 1000V



⚠ 1000 V



1210E/GE

chave de fendas Evox-E elétrica



L mm 150 € 183,00 1 012110701

1211E/GE

chave de fendas Evox-E elétrica



L mm 150 € 194,00 1 012110701



1229LP/A6 € 28,00 1 012290300
1,2-1,4-1,8-2-2,4-3 mm

1229LPH/A6

jogo de 6 chaves de relojeroi
1229LP-1229PH

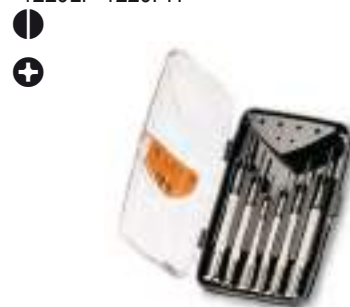

1229LPH/A6 € 28,00 1 012290310

1229LP 1,4-2,0-2,4-3 mm
1229PH PH0-PH1

1236B

chave de parafusos angular
para parafusos de perfil de fenda



UNI 7079 DIN 5200

SxA	L	€		
mm	mm			
0,8x4	100	8,00	5	012360201
1x5,5	125	9,30	5	012360202
1,2x8	150	11,50	5	012360204

1238B

chave de parafusos angular
para parafusos de perfil Phillips®



UNI 7083 DIN 5208

PH	L	€		
	mm			
1-2	125	9,50	5	012380201
3-4	200	15,40	5	012380203

1241

chave de parafusos com ponta de aço
para parafusos de perfil de fenda

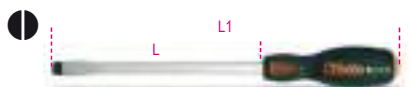

ISO 2380



SxAxL	L1	€		
mm	mm			
1x5,5x100	202	12,50	5	012410039
1,2x6,5x125	240	13,80	5	012410050
1,2x8x150	268	16,80	3	012410057
1,6x10x175	300	21,00	2	012410065
1,6x10x200	325	21,50	2	012410066
2,0x12x200	325	22,60	2	012410067
2,5x14x250	375	24,80	2	012410076



1242

chave de parafusos com ponta de aço
para parafusos com perfil Phillips®



UNI/ISO 8764



PHxDxL	L1	€		
mm	mm			
1x4,5x100	202	12,30	5	012420209
2x6x100	215	14,50	5	012420218
3x8x150	268	18,60	3	012420221
4x11x200	325	24,10	2	012420224

1243LP/D6

jogo 6 chaves de fendas com cabeça em aço,
para parafusos de cabeça ranhurada



	€		
1243LP/D6	112,00	1	012430016
1241			

1243/D7

Jogo de 7 chaves de parafusos com ponta de
aço



	€		
1243/D7	110,00	1	012430017
1241			

1243/S11

jogo 11 chaves de fendas com cabeça em aço



	€		
1243/S11	202,00	1	012430021
1241			

1250

chaves de fenda com guia prensili



SxDxL	L1	€		
mm	mm			
0,5x3x125	190	17,70	5	012500030
0,6x4x125	225	19,10	5	012500040
0,7x5x150	255	22,50	5	012500050

1251

chaves para parafusos de perfil Phillips®
com guia prensili



PHxDxL	L1	€		
mm	mm			
0x4x125	225	19,90	5	012510000
1x5x125	225	23,00	5	012510010
2x6x175	280	26,50	5	012510020

1252/S5



	€		
1252/S5	109,00	1	012520001
1250			

1253

busca-pólos 150/250V

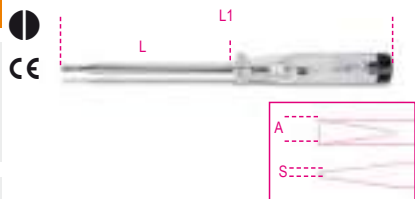

SxAxL mm	L1 mm	€	5	012530001
0,5x3,5x100	190	11,30		

1253A

busca-pólos 125/250V,
duplo isolamento

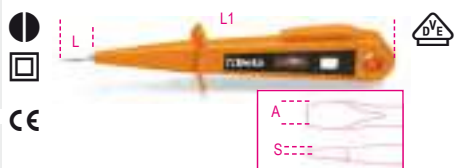

SxAxL mm	L1 mm	€	5	012530010
0,5x3x15	150	8,00		

1254

busca-pólos 6/24V

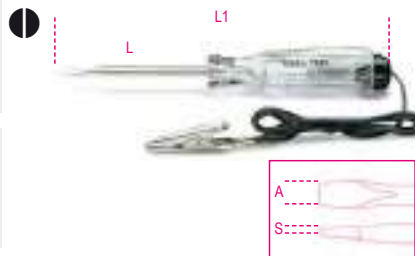

SxAxL mm	L1 mm	€	5	012540001
0,5x3x44	123	12,40		

1256/C36-2

punho para micro-chaves com 36 pontas
intermutáveis de 4 mm e extensão magnética



1256/C36-2	€	5	012560100
	75,00		

	1256TX	T3 - T4 - T5 - T6 - T7 T8 - T9 - T10 - T15
	1256RTX	T6 - T7 - T8 - T9 - T10
	1256LP	0,8 - 1,2 - 1,5 - 1,8 - 2 - 2,5 3 - 3,5 - 4 mm
	1256PE	0,7 - 0,9 - 1,3 - 1,5 - 2 mm
	1256PH	PH000 - PH00 - PH0 - PH1
	1256PZ	PZ000 - PZ00 - PZ0 - PZ1
	1256/20	
	1256/30	

130x60x35 mm - 200 g

1256LP

bits 4 mm
para parafusos ranhurados

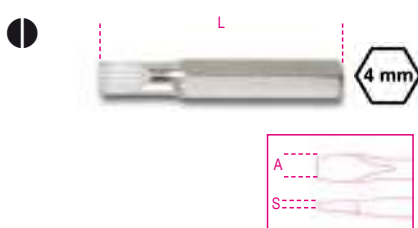

SxA	L	€	5	012560001
0,25x0,8	27	1,45		
0,25x1,2	27	1,45		
0,3x1,5	27	1,45		
0,35x1,8	27	1,45		
0,4x2,0	27	1,45		
0,4x2,5	27	1,45		
0,5x3,0	27	1,45		
0,6x3,5	27	1,45		
0,8x4,0	27	1,45		

1256PH

bits 4 mm
para parafusos Phillips®



PH	L	€	5	012560011
000	27	1,45		
00	27	1,45		
0	27	1,45		
1	27	1,45		

1256PZ

bits 4 mm
para parafusos de cabeça ranhurada Pozidriv®
- Supradriv®



PZ	L	€	5	012560061
000	27	1,45		
00	27	1,45		
0	27	1,45		
1	27	1,45		

1256PE

bits 4 mm
para parafusos sextavados



mm	L	€	5	012560021
0,7	27	1,45		
0,9	27	1,45		
1,3	27	1,45		
1,5	27	1,45		
2,0	27	1,45		

1256TX

bits 4 mm
para parafusos Torx®



T	L	€	5	012560041
T3	27	1,52		
T4	27	1,52		
T5	27	1,52		
T6	27	1,52		
T7	27	1,52		
T8	27	1,52		
T9	27	1,52		
T10	27	1,52		
T15	27	1,52		

1256RTX

bits 4 mm
para parafusos invioláveis "Tamper Resistant
Torx®"



T	L	€	5	012560051
T6	27	1,82		
T7	27	1,82		
T8	27	1,82		
T9	27	1,82		
T10	27	1,82		

1256/20

extensão sextavada, 4 mm

1256/20	€	5	012560092
	9,20		

1256/30

porta-bits 4 mm com punho

1256/30	€	5	012560097
	10,90		

1257LP

micro-chaves para parafusos de perfil de
fenda



SxD	L	€	5	012570012
0,25x1,2	60	5,80		
0,23x1,5	60	5,80		
0,3x1,8	60	5,80		
0,4x2	60	5,80		
0,4x2,5	60	5,80		

SxD mm	L mm	€		
0,5x3	60	5,80	5	012570030
0,6x3,5	60	5,80	5	012570035
0,8x4	60	5,80	5	012570040



1257LP/S8	€		
0,2x1,2-0,25x1,5 0,3x1,8-0,4x2,0-0,4x2,5 0,5x3-0,6x3,5-0,8x4 mm	73,00	1	012570200

1257PH

micro-chaves para parafusos de perfil Philips®



PH	L mm	€		
00	60	5,80	5	012570060
0	60	5,80	5	012570063
1	60	5,80	5	012570066

1257LPH/S8

Jogo de 8 micro-chaves (refa. 1257LP, 1257PH) em caixa



1257LPH/S8	€		
1257PH PH00-PH0-PH1 1257LP 0,4x2-0,4x2,5-0,5x3 0,6x3,5-0,8x4 mm	73,00	1	012570210

1257ES

micro-chaves com ponta macho hexagonal



mm	L mm	€		
0,9	60	6,60	5	012570045
1,3	60	6,60	5	012570046
1,5	60	6,60	5	012570047
2	60	6,60	5	012570048
2,5	60	6,60	5	012570049
3	60	6,60	5	012570050

1257ESB/S8



1257ESB/S8	€		
1257ES 0,9-1,3-1,5-2-2,5-3 mm 1257BE 4-5 mm	83,00	1	012570230

1257TX

micro-chaves para parafusos de perfil Torx®



T	L mm	€		
T5	60	6,90	5	012570075
T6	60	6,90	5	012570076
T7	60	6,90	5	012570077
T8	60	6,90	5	012570078
T9	60	6,90	5	012570079
T10	60	6,90	5	012570080
T15	60	6,90	5	012570081
T20	60	6,90	5	012570082



1257TX/S8	€		
T5-T6-T7-T8 T9-T10-T15-T20	81,50	1	012570220

1257BE

micro-chave de fenda para parafusos macho sextavados



mm	L mm	€		
3,2	60	8,60	5	012570085
4	60	8,60	5	012570086
5	60	8,60	5	012570087
5,5	60	8,60	5	012570088



Beta

Beta



As chaves BetaGrip são fruto da longa experiência da Beta no design de chaves de fendas e da estreita colaboração com mecânicos de equipas de automobilismo. Novas e exclusivas soluções técnicas, capazes de satisfazer os requisitos dos profissionais mais exigentes, foram utilizadas com o objetivo de alcançar os mais altos padrões de ergonomia, robustez e qualidade dos materiais.

- A haste é fabricada em aço especial com elevado teor de silicone, cromo e vanádio, para garantir uma excelente performance em termos de força de torção e flexibilidade. O acabamento escolhido foi um revestimento cromado mate.
- A geometria da ponta foi concebida para assegurar um encaixe perfeito entre a haste e a cabeça do parafuso. O acabamento com revestimento de fosfato previne a oxidação da ponta, mantendo simultaneamente perfis perfeitos.
- A textura foi buscar inspiração aos rastros dos pneus de Corrida, desenvolvidos para maximizar a aderência em diferentes pavimentos. Garante assim uma retenção eficiente da chave de fendas em quaisquer condições de trabalho, para maior precisão e controlo ao encaixar a ponta no parafuso.



1260

chaves para parafusos de perfil de fenda



ISO 2380

SxAxL mm	L1 mm	Ø mm	€	U	U
0,4x2,5x50	150	2,5	6,00	5	012600003
0,4x2,5x75	175	2,5	6,30	5	012600006
0,5x3x75	175	3,0	6,40	5	012600009
0,5x3x100	200	3,0	6,60	5	012600012
0,6x3,5x75	175	3,5	6,80	5	012600018
0,6x3,5x100	200	3,5	6,90	5	012600021
0,8x4x100	208	4,0	7,50	5	012600030
0,8x4x125	233	4,0	7,90	5	012600033
0,8x4x150	258	4,0	8,20	5	012600036
1x5,5x100	208	5,0	8,60	5	012600039
1x5,5x125	233	5,0	8,80	5	012600040
1x5,5x150	258	5,0	9,60	5	012600042
1,2x6,5x100	219	6,0	10,40	5	012600048
1,2x6,5x125	244	6,0	10,80	5	012600050
1,2x6,5x150	269	6,0	11,20	5	012600051
1,2x8x150	277	8,0	13,70	3	012600057
1,2x8x200	327	8,0	14,10	3	012600060
1,6x10x200	327	9,5	17,10	3	012600066
2x12x250	377	10	20,30	3	012600069
2x14x250	377	10	21,50	2	012600073



1260/S6	€	U	U
0,4x2,5x75-0,5x3x75-0,8x4x125 1x5,5x150-1,2x6,5x150-1,2x8x200 mm	55,50	1	012600306

1260N

chaves para parafusos de perfil de fenda, série extra curta



ISO 2380

SxAxL mm	L1 mm	Ø mm	€	U	U
0,8x4x30	87	4	8,00	5	012600103
1,2x6,5x30	87	6	8,80	5	012600106



1260E

chaves para parafusos de perfil de fenda com sextavado auxiliar



ISO 2380

SxAxL mm	L1 mm	Ø mm	€	📦	🖨️
1,2x6,5x150	269	6,0	14,50	3	012600156
1,2x8x175	301	8,0	17,80	3	012600157
1,6x10x200	327	9,5	20,60	2	012600159
2x12x250	377	9,5	23,90	2	012600162

1260MC

chaves para parafusos de perfil de fenda, coloridas



SxAxL mm	L1 mm	Ø mm	€	📦	🖨️
0,4x2,5x50	150	2,5	6,50	3	012602003
0,6x3,5x75	175	3,5	6,70	3	012602018
0,8x4x100	208	4,0	8,00	3	012602030
1x5,5x150	233	5,0	10,20	5	012602040
1,2x6,5x150	269	6,0	11,70	5	012602051

1262

chaves para parafusos de perfil Phillips®



UNI/ISO 8764

PHxDxL mm	L1 mm	€	📦	🖨️
0x3x60	160	6,40	5	012620003
0x3x100	200	6,80	5	012620006
1x4,5x80	188	8,40	5	012620009
1x4,5x120	228	9,10	5	012620012
2x6x100	219	10,30	5	012620018
2x6x150	269	11,30	5	012620021
3x8x150	277	15,20	3	012620024
4x10x200	327	19,30	3	012620027



1262/S4	€	📦	🖨️
PH0x3x60-PH1x4,5x80 PH2x6x100-PH3x8x150 mm	40,00	1	012620304

1262N

chaves para parafusos de perfil Phillips®, série extra curta



UNI/ISO 8764

PHxDxL mm	L1 mm	€	📦	🖨️
1x4,5x30	87	8,00	5	012620103
2x6x30	87	8,80	5	012620106

1262E

chaves para parafusos de perfil Phillips® com sextavado auxiliar



UNI/ISO 8764

PHxDxL mm	L1 mm	€	📦	🖨️
2x6x150	269	14,50	3	012620153
3x8x175	302	17,60	3	012620156
4x10x200	327	22,20	2	012620159

1262L

chaves para parafusos de perfil Phillips®, série longa



UNI/ISO 8764-1

PHxDxL mm	L1 mm	€	📦	🖨️
0x3x300	400	11,00	3	012620203
1x4,5x300	400	13,20	3	012620205
1x4,5x400	508	15,30	3	012620206
2x6x400	519	19,90	3	012620209

1262MC

chaves para parafusos de perfil Phillips®, coloridas



PHxDxL mm	L1 mm	€	📦	🖨️
0x3x60	160	6,70	3	012622003
1x4,5x80	188	8,70	3	012622009
2x6x100	219	10,80	3	012622018

1263/D...

jogo de chaves de parafusos



1263/D6	€	📦	🖨️
1260 0,5x3x75-0,8x4x100 1x5,5x125-1,2x6,5x150 mm 1262 PH1x4,5x80-PH2x6x100 mm	52,50	1	012630006



1263/D7	€	📦	🖨️
1262 PH0x3x60 PH1x4,5x80 PH2x6x100 mm 1264 0,5x2,5x60-0,6x3x100 0,8x4x125-1x5x125 mm	54,00	1	012630017



1263/D7PZ	€	📦	🖨️
1260 0,5x3x75-0,8x4x100 1x5,5x150-1,2x6,5x150 mm 1269PZ PZ0 - PZ1 - PZ2	63,00	1	012630007



1263/D8	€	📦	🖨️
1260 0,4x2,5x50-0,5x3x75 0,8x4x100-1x5,5x125 1,2x6,5x150 mm 1262 PH0x3x60-PH1x4,5x80 PH2x6x100 mm	65,00	1	012630008



1263/D10	€	📦	🖨️
1260 0,5x3x75-0,6x3,5x100 0,8x4x125-1x5,5x150 1,2x6,5x150 mm 1260N 0,8x4x30 1262 PH0x3x60-PH1x4,5x80 PH2x6x100 mm 1262N PH1x4,5x30	83,00	1	012630010

1263/S12

jogo de 12 chaves de parafusos



1263/S12 € 118,00 1 012630112

1260 0,4x2,5x50-0,5x3x75
0,6x3,5x100-0,8x4x125
1x5,5x125-1,2x6,5x150
1,2x8x200-1,6x10x200 mm
1262 PH0x3x60-PH1x4,5x80
PH2x6x100-PH3x8x150 mm

1263MC/D8

jogo de 8 chaves de parafusos coloridas



1263MC/D8 € 69,00 1 012632008

1260MC 0,4x2,5x50-0,5x3x75
0,8x4x100-1x5,5x125
1,2x6,5x150 mm
1262MC PH0x3x60-PH1x4,5x80
PH2x6x100 mm

1264

jogo de chaves para parafusos de perfil de fenda sem cabeça



SxDxL mm	L1 mm	€	U	1264
0,5x2,5x60	160	6,00	5	012640003
0,6x3x75	175	6,40	5	012640006
0,6x3x100	200	6,60	5	012640009
0,8x4x100	208	7,50	5	012640012
0,8x4x125	233	7,90	5	012640015
1x5x125	233	8,80	5	012640018
1x5x150	258	9,30	5	012640021
1,2x6,5x150	269	11,20	5	012640024



1264/S5 € 40,00 1 012640305
0,5x2,5x60-0,6x3x75
0,8x4x100-1x5x125-1,2x6,5x150 mm

1264L

jogo de chaves para parafusos de perfil de fenda sem cabeça, série longa



SxDxL mm	L1 mm	€	U	1264L
0,5x2,5x200	300	8,90	3	012640203
0,6x3x300	400	10,50	3	012640206
0,8x4x400	508	13,70	3	012640209
1x5x400	508	15,30	3	012640215
1,2x6,5x400	519	18,60	3	012640218

1265ES

chaves hexagonais com punhos



mm	L mm	L1 mm	€	U	1265ES
1,5	100	200	7,30	3	012650015
2	100	200	7,50	3	012650020
2,5	100	200	7,80	3	012650025
3	100	200	8,20	3	012650030
4	100	208	9,00	3	012650040
5	100	219	10,40	3	012650050
6	125	244	11,70	3	012650060
8	150	277	15,60	2	012650080



1265ES/S8 € 77,50 1 012650308
1,5-2-2,5-3-4-5-6-8 mm

1266BP

chaves hexagonais de extremidade esférica com punhos



mm	L mm	L1 mm	€	U	1266BP
2	100	200	8,00	3	012660020
2,5	100	200	8,30	3	012660025
3	125	225	8,60	3	012660030
4	125	233	9,60	3	012660040
5	120	239	11,20	3	012660050
6	140	259	13,00	3	012660060
8	160	287	16,30	2	012660080
10	160	287	19,60	2	012660100



1266BP/S8 € 94,50 1 012660308
2-2,5-3-4-5-6-8-10 mm

1267TX

chaves para parafusos de perfil Torx®, com punhos



mm	L mm	L1 mm	Ø mm	€	U	1267TX
T5	50	150	3	8,90	5	012670005
T6	50	150	3	9,30	5	012670006
T7	50	150	3	9,60	5	012670007
T8	60	160	3	10,10	5	012670008
T9	60	167	4	10,50	5	012670009
T10	80	188	4	10,90	5	012670010
T15	80	188	4	11,50	5	012670015
T20	100	208	4,5	12,20	5	012670020
T25	100	208	5	13,20	5	012670025
T27	115	234	6	13,70	5	012670027
T30	115	234	6	14,40	5	012670030
T40	130	257	7	16,70	2	012670040
T45	130	257	8	18,40	2	012670045



1267TX/D7 € 81,50 1 012670307
T6-T8-T10-T15
T20-T25-T30



1267TX/S13 € 159,00 1 012670312
T5-T6-T7-T8-T9
T10-T15-T20-T25
T27-T30-T40-T45

1267MC/TX

chaves para parafusos de perfil Torx®, com punhos, coloridas



Ø	L mm	L1 mm	Ø mm	€	U	01267
T6	50	150	3	9,80	5	012672006
T8	60	160	3	10,40	5	012672008
T10	80	188	4	11,40	5	012672010
T15	80	188	4	12,20	5	012672015
T20	100	208	4,5	13,00	5	012672020
T25	100	208	5	13,60	3	012672025
T30	115	234	6	14,90	3	012672030



1267MC/TX-D7 € 85,00 1 012672307
T6-T8-T10-T15
T20-T25-T30

1268RTX

chaves para parafusos de perfil Tamper Resistant Torx®, com punhos



Ø	L mm	L1 mm	Ø mm	€	U	01268
T9	60	167	4,0	11,40	3	012680009
T10	80	188	4,0	11,80	3	012680010
T15	80	188	4,0	12,20	3	012680015
T20	100	208	4,5	13,20	3	012680020
T25	100	208	5,0	13,50	3	012680025
T27	115	234	6,0	14,40	3	012680027
T30	115	234	6,0	14,60	3	012680030
T40	130	257	7,0	16,90	2	012680040



1268RTX/S8 € 108,00 1 012680307
T9-T10-T15-T20
T25-T27-T30-T40

1269PZ

chaves para parafusos de perfil Pozidriv®-Supadriv®



UNI/ISO 8764

PZ	L mm	L1 mm	€	U	01269
0	60	160	7,30	5	012690000
1	80	188	9,50	5	012690001
2	100	219	11,40	5	012690002
3	150	277	16,30	3	012690003
4	200	327	20,80	3	012690004



1269PZ/S4 € 44,50 1 012690304
PZ0-PZ1-PZ2-PZ3

1269N/PZ

chaves para parafusos de perfil Pozidriv®-Supadriv®, série extra curta



UNI/ISO 8764

PZ	L mm	L1 mm	€	U	01269
1	30	87	8,00	5	012690011
2	30	87	8,80	5	012690012

1281BG

punho para chave de parafusos de lâmina intermutável



L mm	Ø mm	€	U	01281
118	10	13,40	5	012810280

1281PM

porta-pontas magnético de fixação rápida



L mm	€	U	01281
165	22,80	5	012810292

1281PB

porta-chaves de caixa com quadra macho 1/4"



L mm	€	U	01281
175	18,30	5	012810293

1281LP

lâmina reversível intermutável para parafusos de perfil de fenda

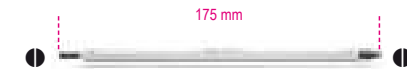

1281LP/1	€	U	01281
0,8x4-1,2x6,5 mm	11,70	5	012810302
1281LP/2	€ <th>U</th> <th>01281</th>	U	01281
1x5,5-1,2x6,5 mm	11,70	5	012810304

1281PH

lâmina reversível intermutável
para parafusos de perfil Phillips®



PH	€	5	012810310
1-2	11,70		
2-3	11,70		012810312

1281LPH

lâmina reversível intermutável
para parafusos de perfil Phillips® e fenda



	€	5	012810321
1281LPH/1 PH0-0,8x4 mm	11,70		
1281LPH/2 PH1-1x5,5 mm	11,70		012810322
1281LPH/3 PH2-1,2x6,5 mm	11,70		012810323

1281PZ

lâmina reversível intermutável
para parafusos de perfil Pozidriv®-Supadriv®



PZ	€	5	012810330
1-2	11,70		
2-3	11,70		012810332

1281PE

lâmina reversível intermutável
hexagonal macho, esférica



mm	€	5	012810342
2,5	11,50		
3	11,50		012810343
4	11,50		012810344
5	11,50		012810345
6	11,50		012810346

1281TX

lâmina reversível intermutável
para parafusos de perfil Torx®

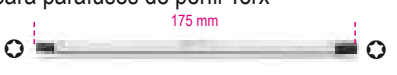

	€	5	012810349
1281TX/1 T6-T8	12,90		
1281TX/2 T7-T9	12,90		012810350
1281TX/3 T10-T15	12,90		012810351
1281TX/4 T20-T25	12,90		012810352
1281TX/5 T30-T40	12,90		012810353

1281RTX

lâmina reversível intermutável
para parafusos de perfil Tamper Resistant
Torx®

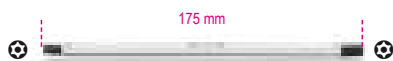

	€	5	012810361
1281RTX/3 T10-T15	13,10		
1281RTX/4 T20-T25	13,10		012810362
1281RTX/5 T30-T40	13,10		012810363

1281BG/A9

jogo 9 chaves reversíveis
e 1 acessório em bolsa

1/4"



1281BG/A9	€	1	012810520
-----------	---	---	-----------

1281BG	
1281LPH/1	PH0-0,8x4 mm
1281LPH/2	PH1-1x5,5 mm
1281LPH/3	PH2-1,2x6,5 mm
1281PZ/1	PZ1-PZ2
1281PE	2,5 mm
1281PE	3 mm
1281PE	4 mm
1281PE	5 mm
1281PE	6 mm

1281BG-TX/A8

jogo 8 chaves reversíveis
e 1 acessório em bolsa

1/4"



1281BG-TX/A8	€	1	012810530
--------------	---	---	-----------

1281BG	
1281LPH/1	PH0-0,8x4 mm
1281LPH/2	PH1-1x5,5 mm
1281LPH/3	PH2-1,2x6,5 mm
1281TX/1	T6-T8
1281TX/2	T7-T9
1281TX/3	T10-T15
1281TX/4	T20-T25
1281TX/5	T30-T40

1281BG/B28NA

sortido de 16 chaves para parafusos
reversíveis, 9 chaves de caixa 1/4", 2
acessórios e 1 punho, em bolsa de poliéster

1/4"



1281BG/B28NA	€	1	012810511
--------------	---	---	-----------

900	4 - 4,5 - 5 - 5,5 6 - 7 - 8 - 9 - 10 mm
1281BG	
1281PB	■ 1/4
900/25	
1281LP/1	0,8x4 - 1,2x6,5 mm
1281LP/2	1,0x5,5 - 1,2x6,5 mm
1281PH/1	PH1 - PH2
1281PH/2	PH2 - PH3
1281PZ/1	PZ1 - PZ2
1281PZ/2	PZ2 - PZ3
1281PE	2,5 - 3 - 4 - 5 - 6 mm
1281TX/1	T6 - T8
1281TX/2	T7 - T9
1281RTX/3	T10 - T15
1281RTX/4	T20 - T25
1281RTX/5	T30 - T40

2002/BV7-ZIP	€	1	020020060
--------------	---	---	-----------

As **chaves de fendas BetaMax** possuem várias características técnicas que proporcionam ainda maior facilidade de trabalho.

- O punho, inspirado na secção triangular, assegura um trabalho excelente, com um alcance de 120°, em linha com a rotação máxima do pulso.
- O design confere extraordinárias propriedades em termos de ergonomia durante as operações de aparafusar com rapidez e de apertar.
- A ponta sem cromado e com revestimento de fosfato anti-oxidação, garante o encaixe perfeito com o parafuso.

1290

chaves para parafusos de perfil de fenda

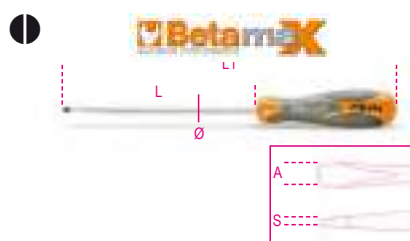

ISO 2380

SxAxL mm	L1 mm	Ø mm	€	👤	📦
0,4x2,5x50	146	2,5	7,70	5	012900003
0,4x2,5x75	171	2,5	8,00	5	012900006
0,5x3x75	171	3,0	8,10	10	012900009
0,5x3x100	196	3,0	8,50	10	012900012
0,6x3,5x75	171	3,5	9,20	10	012900018
0,6x3,5x100	196	3,5	9,40	10	012900021
0,8x4x100	196	4,0	9,50	10	012900030
0,8x4x125	221	4,0	9,70	10	012900033
0,8x4x150	246	4,0	10,40	10	012900036
1x5,5x100	209	5,0	10,60	10	012900039
1x5,5x150	259	5,0	11,70	10	012900042
1,2x6,5x100	220	6,0	13,20	10	012900048
1,2x6,5x150	270	6,0	13,90	10	012900051
1,2x8x150	282	7,0	17,40	3	012900057
1,2x8x200	332	7,0	18,50	3	012900060
1,6x10x200	332	8,0	21,70	3	012900066
2x12x250	382	10	29,00	2	012900069

1290/S

jogo de chaves de parafusos



1290/S5	€	👤	📦
1290 0,5x3x75-0,8x4x100 -1x5,5x150 1,2x6,5x150 -1,2x8x150 mm	61,00	1	012900305

1290/S9X	€	👤	📦
1290 0,4x2,5x75 - 0,5x3,5x100 0,8x4x125 - 1x5,5x150 1,2x6,5x150 - 1,2x8x200 1,6x10x200 mm	114,00	1	012900319
1290N 0,8x4x30 -1,2x6,5x30 mm			

1290N

chaves série curta para parafusos de perfil de fenda



ISO 2380

SxAxL mm	L1 mm	Ø mm	€	👤	📦
0,8x4x30	86	4	10,00	5	012900103
1,2x6,5x30	86	6	11,10	5	012900106

1292

chaves para parafusos de perfil Phillips®

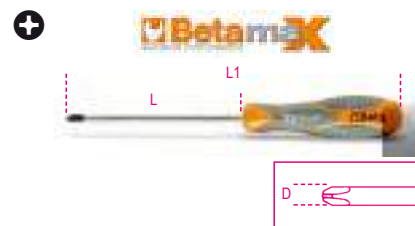

UNI/ISO 8764

PHxDxL mm	L1 mm	€	👤	📦
0x3x60	156	7,30	10	012920003
0x3x100	196	8,40	5	012920006
1x4,5x80	189	10,10	10	012920009
1x4,5x120	229	11,20	10	012920012
2x6x100	220	13,40	10	012920018
2x6x150	270	14,30	10	012920021
3x8x150	282	18,30	3	012920024
4x10x200	332	25,00	3	012920027



1292/S4	€	👤	📦
PH0x3x60-PH1x4,5x80 PH2x6x100-PH3x8x150 mm	48,50	1	012920304

1292N

chaves série curta para parafusos de perfil Phillips®



UNI/ISO 8764

PHxDxL mm	L1 mm	€	👤	📦
1x4,5x30	86	9,60	5	012920103
2x6x30	86	10,50	5	012920106

1292L

chaves série longa para parafusos de perfil Phillips®

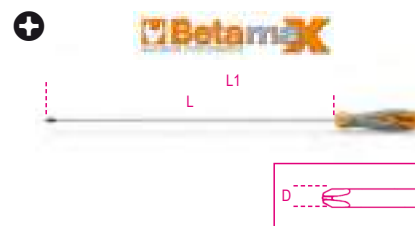

UNI/ISO 8764-1

PHxDxL mm	L1 mm	€	👤	📦
0x3x300	396	16,30	3	012920203
1x4,5x400	509	20,10	3	012920206
2x6x400	520	24,70	3	012920209



1293/D...

jogo de chaves de parafusos

Betamax



1293/D6 € 65,50 1 012930401

1290 0,6x3,5x75-1x5,5x150
1,2x6,5x150 mm
1292 PH0x3x60 -PH1x4,5x80
PH2x6x100 mm



1293/D8 € 91,50 1 012930403

1290 0,5x3x75-0,8x4x100
1x5,5x150-1,2x6,5x150
1,2x8x150 mm
1292 PH0x3x60 -PH1x4,5x80
PH2x6x100 mm

1293/S...

jogo de chaves de parafusos

Betamax



1293/S8 € 81,50 1 012930208

1290 2,5x50-3x75-4x100-5,5x150
6,5x150 mm
1292 PH0x3x60-PH1x4,5x80
PH2x6x100 mm



1293/S10 € 130,00 1 012930201

1290 0,4x2,5x50 -0,6x3,5x100
1x5,5x100-1,2x6,5x150
1,2x8x150-1,6x10x200 mm
1292 PH0x3x60 -PH1x4,5x80
PH2x6x100-PH3x8x150 mm



1293/S12 € 141,00 1 012930203

1290 0,5x3x75-0,8x4x125
1x5,5x150-1,2x6,5x150
1,2x8x200 mm
1290N 0,8x4x30 mm
1292 PH0x3x60 -PH1x4,5x80
PH2x6x100-PH3x8x150 mm
1292N PH1x4,5x30-PH2x6x30 mm



1293/S7 € 67,00 1 012930207

1292 PH0x3x60 -PH1x4,5x80
PH2x6x100 mm
1294 0,5x2,5x60-0,6x3x75
0,8x4x100-1x5x125 mm

1293ES

chaves hexagonal macho com punho



mm	L mm	L1 mm	Ø mm	€	🔧	📦
2	100	196	3	10,40	5	012930001
2,5	100	196	4	10,40	5	012930002
3	100	196	4	10,70	5	012930003
4	100	196	5	12,00	5	012930004
5	100	209	6	13,40	5	012930005
6	125	245	7	15,20	5	012930006
8	150	282	10	20,10	2	012930008



1293ES/S7 € 92,50 1 012930057
2-2,5-3-4-5-6-8 mm

1293BP

chaves hexagonal macho
com extremidade esférica e punho



mm	L mm	L1 mm	€	🔧	📦
2	100	196	10,50	5	012930501
2,5	100	196	10,50	5	012930502
3	100	196	10,80	5	012930503
4	100	196	12,00	5	012930506
5	100	209	13,40	5	012930509
6	125	245	15,50	5	012930512
8	150	282	21,00	2	012930515



1293BP/S7 € 94,00 1 012930558
2-2,5-3-4-5-6-8 mm

1294

chaves para parafusos
de perfil de fenda sem cabeça



SxDxL mm	L1 mm	€	🔧	📦
0,5x2,5x60	156	7,20	5	012940003
0,6x3x75	171	7,60	5	012940006
0,6x3x100	196	7,80	5	012940009
0,8x4x100	196	9,50	5	012940012
0,8x4x150	246	12,40	5	012940015
1x5x125	234	11,80	5	012940018
1,2x6,5x150	282	14,00	5	012940027



1294/S5 € 50,50 1 012940305
0,5x2,5x60-0,6x3x100
0,8x4x100-1x5x125
1,2x6,5x150 mm

1294L

chaves série longa para parafusos
de perfil de fenda sem cabeça



SxDxL mm	L1 mm	€	🔧	📦
0,6x3x300	396	15,70	3	012940206
0,8x4x400	496	18,50	3	012940209
1x5x400	509	22,60	3	012940215
1,2x6,5x400	532	25,50	3	012940218

1295

desandador de percussão



1295 € 67,00 1 012950001
L mm 130

Beta
QUALITY TOOLS

1295/C14

desandador de percussão com 14 pontas e 1 porta pontas



1295/C14 € 176,00 1 012950108

	866LP	1,2x6,5 - 1,6x10 mm
	866PH	PH2 - PH3
	866PZ	PZ2 - PZ3
	866PE	5 - 6 mm
	866TX	T27 - T30 - T40 - T45 - T50 - T55
	895/6	□ 1/2 - ○ 5/16
	1295	■ 1/2

170x100x35 mm - 1,3 kg

1297TX

chaves com punho para parafusos de perfil Torx®



⊕	L mm	L1 mm	∅ mm	€	📦	📄
T6	50	146	3,0	13,60	5	012970006
T7	50	146	3,0	13,80	5	012970007
T8	60	156	3,0	13,90	5	012970008
T9	60	169	4,0	14,40	5	012970009
T10	80	189	4,0	15,40	5	012970010
T15	80	189	4,0	15,50	5	012970015
T20	100	209	4,5	15,90	5	012970020
T25	100	209	5,0	16,40	5	012970025
T27	115	235	6,0	16,90	5	012970027
T30	115	235	6,0	17,80	5	012970030
T40	130	262	7,0	19,80	2	012970040
T45	130	262	8,0	22,50	2	012970045



1297TX/S12 € 196,00 1 012970312

T6-T7-T8-T9-T10
T15-T20-T25-T27
T30-T40-T45



1297TX/D6 € 98,00 1 012970409

1297TX/L

chaves com punho para parafusos de perfil Torx®, série longa



⊕	L mm	L1 mm	∅ mm	€	📦	📄
T15	210	319	4,0	17,20	2	012970115
T20	210	319	4,5	17,70	2	012970120
T25	210	319	5,0	18,30	2	012970125
T30	210	330	6,0	19,60	2	012970130
T45	210	342	8,0	21,30	2	012970145



1297TX/L-S5 € 94,00 1 012970325

TX/L15-TX/L20-TX/L25-TX/L30-TX/L45

1298RTX

chaves com punho para parafusos de perfil Tamper Resistant Torx®

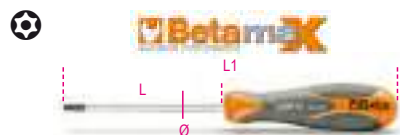

⊕	L mm	L1 mm	∅ mm	€	📦	📄
T9	60	169	4,0	15,90	5	012980009
T10	80	189	4,0	16,20	5	012980010
T15	80	189	4,0	17,20	5	012980015
T20	100	209	4,0	17,30	5	012980020
T25	100	209	4,5	17,70	5	012980025
T27	115	235	5,5	19,10	5	012980027
T30	115	235	6,0	19,80	5	012980030
T40	130	262	7,0	21,30	2	012980040



1298RTX/S8 € 145,00 1 012980308

T9-T10-T15-T20
T25-T27-T30-T40

1299PZ

chaves para parafusos de perfil Pozidriv® - Supadriv®



UNI/ISO 8764

PZ	L mm	L1 mm	€	📦	📄
0	60	156	10,60	5	012990000
1	80	189	12,50	5	012990003
2	100	220	16,90	5	012990006
3	150	282	24,50	2	012990009
4	200	332	34,50	2	012990012



1299PZ/S6 € 89,50 1 012990306

1299PZ PZ0-PZ1-PZ2-PZ3
1299N/PZ PZ1-PZ2

1299N/PZ

chaves série curta para parafusos de perfil Pozidriv® - Supadriv®



UNI/ISO 8764

PZ	L mm	L1 mm	€	📦	📄
1	30	86	12,00	5	012990021
2	30	86	13,40	5	012990024

Beta
Quality Tools

REPARAÇÃO DE VEÍCULOS

As nossas ferramentas para reparação de veículos, usadas pelos profissionais mais exigentes, são desenvolvidas e fabricadas para cumprir as normas mais rígidas a nível mundial, e são testadas com regularidade sob as mais difíceis condições de trabalho.

Há mais de 50 anos que temos o orgulho de trabalhar de mãos dadas com os melhores, que nos ajudam a melhorar continuamente os nossos produtos e são testemunhas dos mais elevados padrões de qualidade.

As ferramentas de reparação de veículos encontram-se nas seguintes secções:

Diagnóstico	itens 1438 a 1499 itens 1758VT a 1760TMC
Motor	itens 955 a 989A itens 1438 a 1499
Óleo e filtros	itens 1438 a 1499 itens 1877 a 1885
Sistema elétrico	itens 1438 a 1499
Arrancadores	itens 1498BC/12 a 1498/40A
Transmissão	itens 1438 a 1499
Suspensão	itens 1549 a 1569CP
Travões	itens 1438 a 1499
Rodas	itens 955 a 989A
Carroçaria	itens 1302 a 1369 itens 1763 a 1767A
Outros equipamentos	itens 1875LT a 3067
Elevação	itens 3029/2T a 3067/70-13T



1302

encontrador duplo com punho com almofada convexa e pena



770 g € 109,00 1 013020001

1303

encontrador tipo virgula



1350 g € 82,50 1 013030001

1304

encontrador tipo palmilha com entalhe



875 g € 104,00 1 013040001

1305

encontrador curvo



1190 g € 66,00 1 013050001

1305Z

encontrador curvo serrilhado

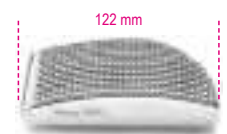

1065 g € 78,00 1 013050002

1306

encontrador tipo tacão



1040 g € 62,00 1 013060001

1307

encontrador rectangular



1100 g € 121,00 1 013070001

1308

encontrador oval



1100 g € 113,00 1 013080001

1310

encontrador tipo trilho



1225 g € 70,00 1 013100001

1312

encontrador tipo bigorna



1220 g € 150,00 1 013120001

1314

encontrador redondo duplo
com almofadas convexa e plana



g 760 € 66,50 1 013140001

1326

colher estreita simples



g 560 € 59,50 1 013260001

1327

colher larga simples



g 1075 € 83,00 1 013270001

1328

colher côncava simples



g 935 € 75,50 1 013280001

1329

colher dupla com mesas largas



g 1800 € 230,00 1 013290001

1330

colher dupla pescoço de cisne
com mesas largas



g 2125 € 245,00 1 013300001

1331

colher curva com face em couro



g 1100 € 136,00 1 013310001

1335BM

lima de bancada com punho plástico



g 500 € 40,00 2 013350010

1337/S5

jogo de 5 espátulas para reparação auto, em
aço inoxidável

Tipo Japonês
(25-50-75-100-125 mm)



L mm 25-50-75-100-125 € 15,30 1 013370015

1338A - 1338B

armações flexíveis com lima de chapreiro



mm 1" L mm € 1338A 9 360 113,00 2 013380001
1338B 12 360 119,00 2 013380002

1338

armação para limas para refª. 1338R



1338 € 61,50 2 013380003

1338R9 - 1338R12

limas de substituição
para refªs. 1338A-B



mm 1" € 1338R9 9 51,50 2 013380004
1338R12 12 57,50 2 013380005

1342

talhadeira extra-chata com lâmina direita



L mm 235 € 35,50 5 013420001

1342PM

talhadeira chata com cortante direito
com punho de protecção



L mm 235 L1 mm 118 € 50,50 2 013420002

1342PMR

punho de protecção para refª. 1342



1342PMR € 14,70 1 013420003

1343

talhadeira chata com lâmina oblíqua



L mm 200 € 37,00 5 013430001

1344

Apalpa folgas para bate-chapas , par, 10-lâminas, com ventosa de apoio

Indicado para :

- colocação de vidros traseiros
- controlo de distância entre painéis



1344 € 42,50 1 013440010

1344A/VW

ferramenta de remoção do gancho de fixação para puxadores Volkswagen



L mm 260 € 19,60 1 013440100

1345

martelo com cabeça convexa redonda e pena, larga cabo em madeira



1345 € 52,50 2 013450010

1351

martelo com cabeça plana redonda e pena pontiaguda, cabo em madeira



1351 € 52,50 2 013510010

1353

martelo com cabeças redondas plana e convexa, cabo em madeira



1353 € 52,50 2 013530010

1357Z/45

martelo com cabeça redonda serrilhada e quadrada plana, cabo em madeira



1357Z/45 € 86,00 2 013570045

1359T

martelo com cabeça plana redonda e pena horizontal, cabo em madeira



1359 T € 52,50 2 013590010

1360G

Martelo anti-recuo em borracha suave, para instalação de juntas e componentes delicados

As faces extremamente suaves deformam-se para absorver o impacto, prevenindo danos nos componentes a trabalhar



L mm 280 Ø mm 72 € 86,50 1 013600000

1360/K6

Martelo de alumínio com batente plano, com pinos de plástico intermutáveis e punção

Fornecido com :

- 4 pinos de plástico
- 1 punção, ajustável em dois comprimentos diferentes, aplicável ao martelo



L mm 320 Ø mm 34 € 99,50 1 013600006

1360/KP3

Kit de martelos plásticos com ponta redonda e pontiaguda, com punção

Kit contém:

- 1 martelo de 210 g com cabeça Ø 30 mm
- 1 martelo de 290 g com cabeça Ø 40 mm
- 1 punção de 75 g com ponta 5 mm



1360/KP3 € 95,50 1 013600503

1361/C12

Conjunto de pontas em Teflon® para reparação de carroçarias



1361/C12 € 150,00 1 013610012

275x160x57 mm

1361/K9

kit de 8 pontas para reparação de carroçarias

kit inclui:

- ponta de cabeça esférica, Ø 31 mm, comp. 110 cm
- ponta em bico, comp. 62 cm
- ponta cauda de baleia, comp. 112 cm
- ponta de gancho, comp. 27 cm
- ponta de cabeça redonda plana, comp. 50 cm
- ponta de cabeça esférica, Ø 19 mm, comp. 52 cm
- ponta cauda de baleia, comp. 27 cm
- ponta redonda cauda de baleia, comp. 28 cm
- saco em tecido com pegas

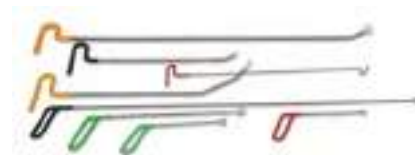

1361/K9 € 353,00 1 013610030

1362B

refletor de mossas circular em material têxtil

- superfície totalmente revestida com material anti-riscos
- fornecido em pequeno saco de transporte



1362B	∅ mm	€	1	013620011
	755	90,50		

1364SE

apoio extensível para oficina

Especificações:

- 4 rodízios giratórios, 2 com travões
- pantógrafo extensível até 1400 mm
- regulação vertical até 1315 mm
- bloqueio de posição
- superfície de contacto com revestimento amovível em borracha

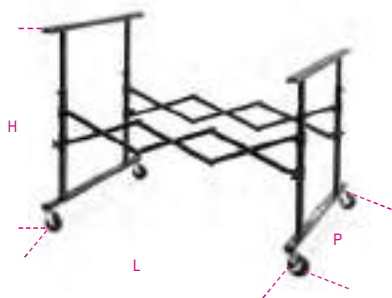

	L mm	H mm	P mm	€	1	013640001
	215÷1400	780÷1315	890	466,00		

1364SV

apoio para oficina
com tabuleiro central

Especificações:

- superfície de contacto com revestimento em polietileno
- dimensões do tabuleiro: 340x845x40 mm
- dobrável



	H mm	€	1	013640002
	1000	265,00		

1364SCP

apoio giratório para oficina

particularmente adequado para capôs, laterais e portas
equipado com 4 rodízios - 2 giratórios com travões,
podem ser rodados até 180°

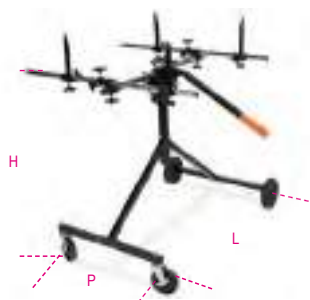

	H mm	L mm	P mm	€	1	013640003
	1300	1100	680	425,00		

1364SP

suporte de trabalho com ventosas

particularmente adequado para usar com janelas
equipado com 4 ventosas, ∅ 95 mm
extensão ajustável através de corrente
tubos com revestimento em polietileno

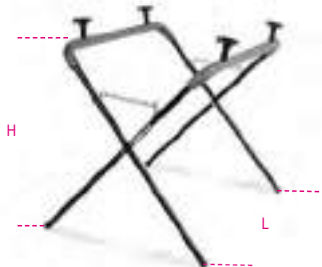

	H mm	L mm	€	1	013640004
	1250	950	212,00		

1364SR

trolley para
rolos de papel

Especificações:

- com 2 rodas
- 3 barras para rolos de papel com lâmina de corte integrada
- suporte para fita cola integrado
- dimensões máx. do rolo de papel: 350 - 650 - 1050 mm

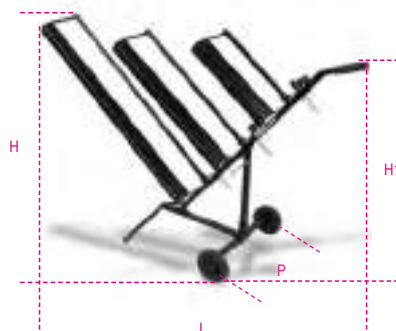

	L mm	P mm	H mm	H1 mm	€	1	013640005
	1530	520	1080	960	271,00		

1365/K13

kit chapeiro com bomba hidráulica 10 t e
acessórios em trolley

O kit inclui:

- bomba hidráulica, 10 t, com tubo 1,5 m comp., união1/2"
- pistão
- pinça; capacidade: 500 kg
- placa base, 150x90 mm
- base em L, 50x50 mm
- punção 4 pontos
- punção redonda, ∅ 50 mm
- punção cunha, 43 mm
- extensão 240-mm
- extensão 450-mm
- extensão 475-mm
- cabeça em borracha
- união macho-macho para instalar acessórios



1365/K13	€	1	013650013
	920,00		

900x420x180 mm

1365P10

bomba hidráulica

tubo 1,5m comp, união 1/2"



1365P10	€	1	013650110
	409,00		

1366A

Tira mossas
com kit de 19 pinos plásticos

Ideal para remover:

- mossas causadas por granizo
- mossas no estacionamento
- pequenas mossas em geral



1366A	€	1	013660200
	104,00		

1366B

contrapeso para
pinos plásticos tira mossas

peso percurtor: 500 g



L
mm 440 € 58,00 1 013660250

1366KF

Conjunto de 19 pinos plásticos,
para artigo 1366A



1366/KF € 37,50 1 013660205

1366/K5

tira-mossas pneumático, com percurtor de 1.1
kg

O kit inclui:

- 1 ventosa Ø 75 mm
- 1 ventosa Ø 100 mm
- 1 ventosa Ø 125 mm
- 1 gancho



1366/K5 € 271,00 1 013660010

610x240x90 mm

1366SH

aparelho de soldar por pontos
multifunções

- microprocessador para gestão dos parâmetros de soldadura
- início automático por contacto ou manual
- função de configuração do tempo de soldadura por pontos
- fornecido com pistola com encaixe rápido e cabo terra de 2.2m comp.

Kit de acessórios inclui:

- martelo extrator
- cabeça cilíndrica para anilhas de três pontas
- 10 anilhas de três pontas
- elétrodo de carvão
- elétrodo de compressão



- Características técnicas:
- Alimentação: 230V
 - 50% potência: 2.5 KVA
 - Pico de potência: 13 KVA
 - Amp. De saída: 2850 (2%) A
 - Amp. Máx. de saída: 3200 A

1366SH € 2.320,00 1 013660400

1366SH/C

trolley para aparelho de soldar por pontos
1366SH



1366SH/C € 452,00 1 013660410

1366SL

alavanca tira-mossas para superfícies
metálicas

Cabeça articulada com garra para utilização com arame
ondulado



L
mm 700 € 273,00 1 013660002

1366ST

barra tira-mossas para superfícies metálicas e
alumínio

Cabeça articulada com garra para utilização com arame
ondulado e olhais de tração



L
mm 850 € 690,00 1 013660003

1366S/R1

Mandril 3 pontas



1366S/R1 € 27,00 1 013660501

1366S/R2

Anilhas de 3 pontas
para trabalhos em chapa



1366S/R2 € 27,00 1 013660502

Preço para 20 unid.

1366S/R3

electrodo para anilhas
Ø 8x16x1.5 mm



1366S/R3 € 32,50 1 013660503

 **Beta**

1366S/R4

Grampo, Ø 8x16x1.5 mm



1366S/R4 € 28,50 1 013660504

1366S/R5

Anilhas Ø 8x16x1.5mm



1366S/R5 € 15,60 1 013660505

Preço para 100 unid.

1366S/R6

Electrodo para parafusos M5-M6



1366S/R6 € 31,00 1 013660506

1366S/R7

100 pinos auto-roscantes, 5x18 mm



1366S/R7 € 27,00 1 013660507

1366S/R8

100 pinos auto-roscantes, 5x25 mm



1366S/R8 € 37,00 1 013660508

1366S/R9

100 pinos roscados, M5 x 18 mm



1366S/R9 € 25,00 1 013660509

1366S/R10

10 anilhas com fenda



1366S/R10 € 17,30 1 013660510

1366S/R11

Electrodo para anilhas com fenda



1366S/R11 € 88,00 1 013660511

1366S/R12

Anilhas com fenda 10 90°



1366S/R12 € 34,50 1 013660512

1366S/R13

Eléctrodo de soldadura por pontos



1366S/R13 € 63,50 1 013660513

Preço para 5 unid.

1366S/R14

Eléctrodo de soldadura por pontos



1366S/R14 € 30,50 1 013660514

1366S/R21

arame ondulado para utilização com alavanca e barra tira-mossas



1366S/R21 € 21,40 1 013660551

Os preços indicados são para 10 unidades.

1366S/R22

suporte magnético para arame ondulado



1366S/R22 € 74,00 1 013660552

1366S/R24

olhal de tração M4



1366S/R24 € 85,50 1 013660554

Os preços indicados são para 5 unidades.

1366S/R25

olhal de tração M5



1366S/R25 € 85,50 1 013660555

Os preços indicados são para 5 unidades.

1366S/R26

olhal de tração M6



1366S/R26 € 85,50 1 013660556

Os preços indicados são para 5 unidades.

1367/S4

jogo de punções para instalação de sensores de estacionamento
tamanhos:
23 - 24 - 27 - 28



1367/S4 € 249,00 1 013670104



1367/K4

kit de 4 grampos para cavas de roda, tipo arco



Abertura máx. mordente: 6.5 mm

	L	H	S	€		
	mm	mm	mm			
1367/K4	62	40+58	15,7	76,50	1	013670010

1367/K10

Jogo de punções para instalação de sensores de estacionamento

Tamanhos incluídos:

• 17 - 18 - 18.2 - 19 - 20 - 22.5 - 24 - 26 - 26.7 - 32 mm



∅ 12 mm



	€		
1367/K10	210,00	1	013670200

190x130x58 mm

1368

kit de reparação para plásticos

• Permite reparar rapidamente componentes em plástico rachados ou partidos

Potência: 220+240 V com tomada Schuko

Extensão cabo pistola de calor: 3.5 m

Comp. cabo elétrico: 1.35 m

2 regulações de potência: 35-75 W

Pistola de aquecimento com terminais em latão, 2 ângulos de

inserção do grampo: 0°-90°

Quebra-circuitos térmico de segurança na entrada

Fusível 10 A de segurança na saída

Bolsa para pistola

CE



	€		
1368	490,00	1	013680001

1368G/K400

sortido de 400 grampos para artigo 1368



	€		
1368G/K400	84,00	1	013680140

1368G/OD

grampos roscados, a direito, para artigo 1368



	€		
1368G/OD	21,00	1	013680100

Os preços indicados são para 100 unidades

1368G/SD

grampos em espiral, a direito, para artigo 1368



	€		
1368G/SD	21,00	1	013680110

Os preços indicados são para 100 unidades

1368G/CV

grampos ângulo convexo para artigo 1368



	€		
1368G/CV	21,00	1	013680120

Os preços indicados são para 100 unidades

1368G/C2U

grampos ângulo côncavo para artigo 1368



	€		
1368G/C2U	21,00	1	013680130

Os preços indicados são para 100 unidades

PUNHOS DE MARTELOS

Punhos em madeira de **nogueira**

A nogueira apresenta excelentes propriedades para os punhos dos martelos. A sua estrutura de fibras longas absorve a vibração e torna-a muito resistente a quebras. No caso improvável dessas fibras quebrarem, o risco de queda da cabeça do martelo também é muito reduzido. Os punhos de madeira podem ser substituídos.

Como a madeira é um material natural, deverá reter a sua própria humidade. Assim, o martelo não deve ser armazenado em locais demasiado secos.

Punhos em **fibra de vidro**

Os punhos em fibra de vidro são duráveis e seguros; o risco de quebra e ferimentos é reduzido ao mínimo. São à prova de intempéries e resistentes aos químicos mais comuns.



• **Núcleo em fibra de vidro indestrutível**

• **Estrutura ergonómica em polipropileno**

• **Revestimento confortável em elastómero anti-derrapante**

1369/C11

jogo de 11 ferramentas



1369/C11 € 980,00 1 013690033



470x340x70 mm - 15,2 kg

1370

martelos para mecânico tipo alemão, cabo em madeira



HICKORY

UNI 7778 DIN 1041

g	A mm	L mm	L1 mm	€		
100	15	260	82	13,90	5	013700051
200	19	280	95	15,60	5	013700052
300	23	300	105	17,80	5	013700053
400	25	310	112	20,20	5	013700054
500	27	320	118	21,70	5	013700055
600	30	330	122	25,00	5	013700056
800	33	350	130	28,50	4	013700058
1000	36	360	135	34,00	4	013700060
1500	42	380	145	38,50	2	013700065
2000	47	400	155	46,00	1	013700070

1370/MR...

cabos de substituição para referência 1370



	€		
1370MR 100 1370/100	6,30	4	013700081
1370MR 200 1370/200	7,00	4	013700082
1370MR 300 1370/300	7,60	4	013700083
1370MR 400 1370/400	8,10	4	013700084
1370MR 500 1370/500	8,90	4	013700085
1370MR 600 1370/600	9,80	4	013700086
1370MR 800 1370/800	10,20	4	013700088
1370MR 1000 1370/1000	10,90	4	013700090
1370MR 1500 1370/1500	12,40	4	013700095
1370MR 2000 1370/2000	13,90	4	013700100

1370T

martelos para mecânico cabo em fibra



g	A mm	L mm	L1 mm	€		
200	19	280	95	24,00	5	013700620
300	23	300	105	26,50	5	013700630
500	27	320	118	29,00	5	013700650
800	33	350	130	30,50	4	013700680
1000	36	360	135	38,50	4	013700700
1500	42	365	145	45,50	2	013700750

1370F

martelos para mecânico tipo alemão, cabo em madeira



NF E 71.014

A mm	L mm	L1 mm	€		
24	260	77	24,10	2	013700424
26	260	80	25,50	2	013700426
28	280	86	27,00	2	013700428
30	280	92	28,50	2	013700430
32	300	100	30,00	2	013700432
36	300	104	38,50	2	013700436
40	330	110	42,50	2	013700440
42	330	116	45,50	2	013700442
50	380	138	47,50	2	013700450
60	380	160	59,00	2	013700460

1370F/MR...

cabos de substituição para referência 1370F



	€		
1370F/MR 24 1370F/24-26	6,20	2	013700474
1370F/MR 28 1370F/28-30	6,70	2	013700478
1370F/MR 32 1370F/32-36	7,70	2	013700482
1370F/MR 40 1370F/40-42	9,70	2	013700490
1370F/MR 50 1370F/50	10,90	2	013700495
1370F/MR 60 1370F/60	13,20	2	013700496

1370FT

martelos para mecânicos, cabos em fibra



A mm	L mm	L1 mm	€		
28	280	86	39,50	1	013700528
30	280	92	41,00	1	013700530
32	300	100	42,50	1	013700532
36	300	104	51,00	1	013700536
40	330	110	53,50	1	013700540
42	330	116	55,50	1	013700542
50	380	138	62,50	1	013700550
60	380	160	67,50	1	013700560

1374F

martelo para carpinteiro tipo francês, cabo em madeira



NF E 71.012

A mm	L mm	L1 mm	€		
16	250	80	19,30	2	013740416
20	270	86	21,50	2	013740420
22	290	92	22,20	2	013740422
26	290	103	25,00	2	013740426
28	310	108	26,50	2	013740428
30	310	117	28,00	2	013740430

1374F/MR...

cabos de substituição para referência 1374F



	€		
1374F/MR 16 1374F/16	5,70	2	013740456
1374F/MR 20 1374F/20	5,80	2	013740460
1374F/MR 22 1374F/22-26	5,90	2	013740462
1374F/MR 28 1374F/28	6,70	2	013740468
1374F/MR 30 1374F/30	7,20	2	013740470



1375

martelo de orelhas, cabo em madeira



g	L1 mm	Ø mm	L mm	€	🔧	📦
300	95	25	300	22,20	3	013750000

1375/MR

cabos de substituição para referência 1375



1375/MR	€	🔧	📦
	10,10	2	013750003

1375A

martelo de orelhas, cabo em plástico e fibra de vidro



oz	g	L mm	L1 mm	€	🔧	📦
16	450	330	130	32,00	3	013750016
20	570	330	130	34,00	3	013750020

1375B

martelo de orelhas, cabo em aço



oz	g	L mm	L1 mm	€	🔧	📦
16	450	330	130	29,50	3	013750026
20	570	330	130	30,00	3	013750030

1376X

martelo de carpinteiro com orelhas magnetizadas, cabo de madeira



g	A mm	L1 mm	L mm	€	🔧	📦
250	20	125	450	21,20	3	013760125
300	25	130	450	22,40	3	013760130
400	27	132	450	24,60	3	013760140

1376X/MR

cabo de substituição para o artigo 1376X



1376X/MR	€	🔧	📦
	11,90	2	013760161

1376XT

martelo de carpinteiro com orelhas magnetizadas, cabo em material plástico



g	A mm	L1 mm	L mm	€	🔧	📦
250	20	125	500	25,50	3	013760525
300	25	130	500	27,00	3	013760530
400	27	132	500	29,00	3	013760540

1376XT/MR

cabo de substituição para o artigo 1376XT



1376MR/XT	€	🔧	📦
	13,80	2	013760585

1377

martelos com batente redondo e pena esférica, cabo em madeira



HICKORY

g	L mm	L1 mm	€	🔧	📦
340	330	95	32,00	2	013770134
450	350	102	34,00	2	013770145
570	350	110	38,50	2	013770157
680	360	116	40,50	2	013770168
900	380	120	42,00	2	013770190

1377/MR...

cabos de substituição para referência 1377



1377MR 340 1377/340	€	🔧	📦
	7,10	2	013770234
1377MR 450 1377/450	8,10	2	013770245
1377MR 570 1377/570	9,00	2	013770257
1377MR 680 1377/680	9,10	2	013770268
1377MR 900 1377/900	11,40	2	013770290

1377T

Martelo batente redondo e pena simétrica, cabo redondo em fibra, para trabalhos em latão ou estanho



g	L mm	L1 mm	€	🔧	📦
340	330	95	30,00	2	013770534
450	350	102	36,00	2	013770545
570	350	110	39,50	2	013770557
680	360	116	42,00	2	013770568
900	380	120	48,00	2	013770590

1378

martelos com batente redondo e pena simétrica, cabo em madeira



HICKORY

g	L mm	L1 mm	Ø mm	€	🔧	📦
340	330	100	27	29,50	2	013780134
570	350	115	32	38,50	2	013780157

1378/MR...

cabos de substituição para referência 1378



1378MR 340 1378/340	€	🔧	📦
	6,70	2	013780234
1378MR 570 1378/570	9,30	2	013780257

1379F

martelo tipo francês para electricista, cabo em madeira



HICKORY

NF E 71.011	A mm	L mm	L1 mm	€	🔧	📦
	16	250	126	19,20	2	013790416
	18	250	135	21,00	2	013790418
	20	260	142	22,20	2	013790420

1379F/MR...

cabos de substituição para referência 1379F



g	A mm	L mm	L1 mm	€	U	U
1379F/MR 16				6,00	2	013790426
1379F/16-18						
1379F/MR 20				6,70	2	013790430
1379F/20						

1380

marretas cabo em madeira



HICKORY

UNI 7777 DIN 6475

g	A mm	L mm	L1 mm	€	U	U
800	38	260	90	24,60	2	013800208
1000	40	260	95	26,50	2	013800210
1250	43	260	100	28,00	2	013800212
1500	45	280	110	32,00	2	013800215
2000	50	300	120	41,50	2	013800220

1380/MR...

cabos de substituição para referência 1380



g	A mm	L mm	L1 mm	€	U	U
1380MR 800				7,80	2	013800238
1380/800-1000-1250						
1380MR 1500				8,40	2	013800245
1380/1500						
1380MR 2000				9,60	2	013800250
1380/2000						

1380S

marretas com colar salva mãos cabo em madeira



g	A mm	L mm	L1 mm	€	U	U
800	36	260	90	27,00	2	013800400
1000	39	260	95	30,00	2	013800405
1250	43	260	100	32,00	2	013800410
1500	45	260	110	36,00	2	013800415

1380S/MR...

cabos de substituição para referência 1380S



g	A mm	L mm	L1 mm	€	U	U
1380S/MR 800				8,10	2	013800417
1380S/800-1000-1250						
1380S/MR 1500				8,90	2	013800419
1380S/1500						

1380T

Marreta, cabo em fibra



g	A mm	L mm	L1 mm	€	U	U
800	35	260	85	37,50	2	013800308
1000	40	260	100	38,00	2	013800310
1250	42	260	110	40,50	2	013800312
1500	45	260	120	43,00	2	013800315
2000	49	295	120	52,50	1	013800320

1381

marretas serviço pesado cabo em madeira de castanheiro americano



HICKORY

g	A mm	L mm	L1 mm	€	U	U
3000	55	800	142	101,00	1	013810030
4000	60	900	152	112,00	1	013810040
5000	70	900	162	127,00	1	013810050
8000	80	900	185	220,00	1	013810080

* = cabo em madeira freixo

1381/MR...

cabos de substituição para referência 1381



g	A mm	L mm	L1 mm	€	U	U
1381MR 3-4				49,50	2	013810730
1381/3000-4000						
1381MR 5				52,00	2	013810750
1381/5000						
1381MR 8				52,00	2	013810780
1381/8000						

1381T

marreta com cabo em fibra



g	A mm	L mm	L1 mm	€	U	U
3000	55	900	142	109,00	1	013810330
4000	60	900	152	120,00	1	013810340
5000	70	900	162	137,00	1	013810350
8000	82	920	180	252,00	1	013810380

1385

marretas com cabeça em cobre cabo em madeira



g	A mm	L mm	L1 mm	€	U	U
400	26	260	75	38,00	2	013850404
600	32	270	80	55,50	2	013850406
800	34	280	90	72,50	2	013850408
1000	37	280	100	90,00	2	013850410
1500	43	280	110	133,00	2	013850415
2000	48	300	120	179,00	1	013850420

1385/MR

cabo de substituição para o artigo 1385



g	A mm	L mm	L1 mm	€	U	U
1385MR 400				10,90	2	013850464
1385/400						
1385MR 600				11,30	2	013850466
1385/600						
1385MR 800				11,60	2	013850468
1385/800						
1385MR 1000				12,50	2	013850470
1385/1000						
1385MR 1500				13,90	1	013850475
1385/1500						
1385MR 2000				14,20	1	013850480
1385/2000						

1390

martelos com batentes plásticos intermutáveis, cabo em madeira



UNI 7784

Ø mm	L mm	L1 mm	€	U	U
22	260	70	21,70	5	013900022
28	280	85	27,00	5	013900028
35	310	95	36,50	5	013900035
45	320	107	58,50	4	013900045
60	380	128	99,00	2	013900060

1390/MR...

cabos de substituição para referência 1390



g	A mm	L mm	L1 mm	€	U	U
1390MR 22				5,30	2	013900222
1390/22						
1390MR 28				6,20	2	013900228
1390/28						
1390MR 35				7,30	2	013900235
1390/35						
1390MR 45				8,90	2	013900245
1390/45						
1390MR 60				10,90	2	013900260
1390/60						

1390R

batente de substituição para refª. 1390



Ø mm	€	Unid.	Refª
22	3,45	4	013900122
28	5,30	4	013900128
35	7,10	4	013900135
45	11,90	4	013900145
60	20,70	4	013900160

1390N

Martelo com batentes em plástico, cabo em madeira

Batentes dureza média: 75 Shore

Resistente a óleo e ao desgaste

Particularmente adequado para trabalhar metal



UNI 7784

Ø mm	L mm	L1 mm	€	Unid.	Refª
22	260	70	21,70	3	013900522
28	280	85	27,00	3	013900528
35	310	95	36,50	3	013900535
45	320	107	58,50	2	013900545
60	380	128	99,00	2	013900560

1390NR

batentes em nylon de substituição para ref. 1390N



Ø mm	€	Unid.	Refª
22	3,45	4	013900622
28	5,30	4	013900628
35	7,10	4	013900635
45	11,90	4	013900645
60	20,70	4	013900660

1391

martelos anti-recuo totalmente revestidos a borracha



Ø mm	L mm	L1 mm	€	Unid.	Refª
35	280	90	33,50	2	013910135
50	320	105	43,00	2	013910150
55	355	110	51,50	2	013910155
65	380	130	70,50	2	013910165

1391A

maceta para assentar tijoleira totalmente revestida a borracha branca



g	Ø mm	L mm	L1 mm	€	Unid.	Refª
500	45	290	100	31,00	2	013910205
1000	60	300	120	41,50	2	013910210

1392

martelos anti-recuo com batentes intermutáveis, cabo em aço



Ø mm	L mm	L1 mm	€	Unid.	Refª
30	300	105	56,50	2	013920030
35	305	115	60,00	2	013920035
40	310	125	69,50	2	013920040
50	325	135	81,50	2	013920050
60	385	155	126,00	2	013920060

1392R

batente de substituição para refª. 1392



Ø mm	€	Unid.	Refª
30	7,60	4	013920230
35	11,10	4	013920235
40	16,70	4	013920240
50	22,30	4	013920250
60	33,50	4	013920260

1393

martelo com batente em borracha dura



Ø mm	L mm	L1 mm	€	Unid.	Refª
50	315	90	14,80	3	013930050
60	340	110	16,70	3	013930060
70	370	130	20,10	2	013930070

REPARAÇÃO DE VEÍCULOS

As nossas ferramentas para reparação de veículos, usadas pelos profissionais mais exigentes, são desenvolvidas e fabricadas para cumprir as normas mais rígidas a nível mundial, e são testadas com regularidade sob as mais difíceis condições de trabalho. Há mais de 50 anos que temos o orgulho de trabalhar de mãos dadas com os melhores, que nos ajudam a melhorar continuamente os nossos produtos e são testemunhas dos mais elevados padrões de qualidade.

As ferramentas de reparação de veículos encontram-se nas seguintes secções:

Diagnóstico	itens 1438 a 1499 itens 1758VT a 1760TMC
Motor	itens 955 a 989A itens 1438 a 1499
Óleo e filtros	itens 1438 a 1499 itens 1877 a 1885
Sistema elétrico	itens 1438 a 1499
Arrancadores	itens 1498BC/12 a 1498/40A
Transmissão	itens 1438 a 1499
Suspensão	itens 1549 a 1569CP
Travões	itens 1438 a 1499
Rodas	itens 955 a 989A
Carroçaria	itens 1302 a 1369 itens 1763 a 1767A
Outros equipamentos	itens 1875LT a 3067
Elevação	itens 3029/2T a 3067/70-13T



1410/M

chave de gancho para molas



Ø mm	€	🔧	📦
3,5	21,30	2	014100051

1428

extractor de porcas com quadra macho



Ø mm	□ mm	L mm	○ mm	€	🔧	📦
8	3/8	36	17	20,10	2	014280008
10	3/8	36	17	20,10	2	014280010
11	3/8	36	17	20,10	2	014280011
12	3/8	36	19	20,10	2	014280012
13	3/8	36	19	20,10	2	014280013
14	3/8	36	19	20,10	2	014280014
15	1/2	38	21	21,30	2	014280015
16	1/2	38	21	21,30	2	014280016
17	1/2	38	21	21,30	2	014280017
18	1/2	38	26	21,30	2	014280018
19	1/2	38	26	21,30	2	014280019
20	1/2	38	26	23,60	2	014280020
21	1/2	38	26	23,60	2	014280021
22	1/2	38	26	25,50	2	014280022
24	1/2	38	26	25,50	2	014280024
27	1/2	38	26	27,00	2	014280027

1428L

extractores, série longa, para porcas de aperto direito danificadas, com quadra



Ø mm	€	🔧	📦
17	51,00	1	014280217
19	52,50	1	014280219
21	56,50	1	014280221



1428L/B3	€	🔧	📦
17-19-21 mm	160,00	1	014280303



1428/SB11	€	🔧	📦
8-10-11-12-13-14 15-16-17-18-19 mm	245,00	1	014280111
1428/SB5	€	🔧	📦
20-21-22-24-27 mm	136,00	1	014280115

1429

extractor de porcas e parafusos com quadra macho



mm	□	L mm	€	🔧	📦
2	3/8	60	13,30	3	014290002
3	3/8	60	13,30	3	014290003
4	3/8	60	13,30	3	014290004
5	3/8	60	14,00	2	014290005
6	3/8	60	14,00	2	014290006
8	1/2	70	15,30	2	014290008
10	1/2	70	15,60	2	014290010



1429/SB7	€	🔧	📦
2-3-4-5-6-8-10 mm	111,00	1	014290107

1430/...

extractores cónicos de parafusos em aço ligado

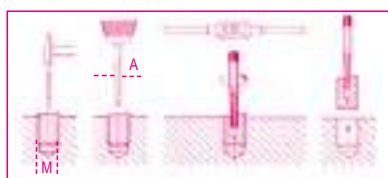

	M	A mm	€	🔧	📦
1430/1	3÷6	2,5	3,70	10	014300006
1430/2	6÷8	3,0	4,15	10	014300008
1430/3	8÷11	4,5	4,95	10	014300011
1430/4	11÷14	6,0	6,60	10	014300014
1430/5	14÷18	8,0	7,40	10	014300018
1430/6	18÷24	11,0	14,50	5	014300024
1430/7	24÷33	14,0	21,80	5	014300033
1430/8	33÷50	21,0	28,00	5	014300050



	€	🔧	📦
1430/S5	28,00	1	014300105
1430/1-1430/2-1430/3			
1430/4-1430/5			
1430/S6	40,00	1	014300106
1430/1-1430/2-1430/3			
1430/4-1430/5-1430/6			
1430/S8	89,50	1	014300108
1430/1-1430/2-1430/3			
1430/4-1430/5-1430/6			
1430/7-1430/8			

1431/...

extractores cónicos para parafusos e pinos

Para remoção de parafusos e pinos difíceis, com mecanismo de percussão

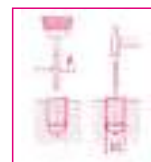

	M	A	L	□	€	🔧	📦
	mm	mm	mm	mm			
1431/3	3÷6	2,5	59	5	6,70	10	014310051
1431/5	6÷8	5,0	68	5	6,70	10	014310052
1431/6	8÷11	6,0	72	6	8,00	10	014310053
1431/8	11÷14	8,0	77	8	8,60	10	014310054
1431/9	14÷18	9,0	82	9	9,30	10	014310055

1431/C5

Extractores cónicos de parafusos e pinos

Mecanismo de percussão



	M	A	€	🔧	📦
	mm	mm			
1431/C5	3÷18	2,5÷9	39,50	1	014310005

1433

Saca pernos

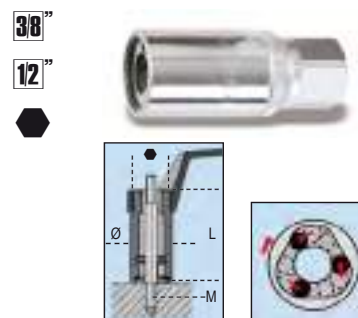

M	Ø	L	●	□	€	🔧	📦
mm	mm	mm	mm				
5	21	60	19	3/8	14,80	2	014330005
6	24	60	21	1/2	14,80	2	014330006
7	24	60	21	1/2	14,80	2	014330007
8	24	60	21	1/2	14,80	2	014330008
9	28	70	21	1/2	17,60	2	014330009
10	28	70	21	1/2	17,60	2	014330010
10,5	28	70	21	1/2	17,60	2	014330021
11	28	70	21	1/2	17,60	2	014330011
12	28	70	21	1/2	17,60	2	014330012
14	36	72	24	-	28,00	2	014330014
16	36	72	24	-	28,00	2	014330016

1433/C11

saca pernos com roletes com encabadouro quadrado fêmea 1/2"

38"
12"
●



1433/C11 € 287,00 1 014330311
M5 - M6 - M7 - M8 - M9 - M10 - M10,5
M11 - M12 - M14 - M16
340x135x56 mm - 3,0 kg

1435

extractor excêntrico de pernos



∅ mm 4÷20 € 108,00 1 014350001

1435R

patela excêntrica de substituição para a ref.^a 1435



1435R € 33,50 1 014350010

1435/1

extractor excêntrico de pernos



∅ mm 19÷26 € 134,00 1 014350002

1435/1R

patela excêntrica de substituição para a ref.^a 1435/1



1435/1R € 34,50 1 014350011

1437/C12

Jogo de 12 ferramentas para remoção de air bags



1437/C12 € 113,00 1 014370001
260x160x55 mm - 1,0 kg

1438

aparelho para centrar embraiagens com 3 cones expansivos



1438 € 61,50 1 014380001

1438R

cones expansivos de substituição para a ref.^a 1438



∅ mm € 5 014380101
14÷18 4,15 5 014380102
18÷21 4,15 5 014380103
22÷25 4,15 5 014380103

1438EVO

Kit universal para alinhar embraiagens

Em metal



1438EVO € 272,00 1 014380011
290x200x60 mm - 2 kg

1438DSG

Alavanca para bloquear/desbloquear caixas de velocidades DSG de dupla embraiagem do grupo VAG



1438DSG € 37,00 1 014380200

1438K/DSG-2

kit para alinhar embraiagens DSG de 6 e 7 velocidades

para utilização com caixas de 6 velocidades DSG e mudanças manuais, caixas de 7 velocidades (série 1 e 2) e caixas de velocidades S-tronic.



1438K/DSG-2 € 685,00 1 014380260
350x370x117 mm - 10 kg

1438K/PWR

ferramenta para remover e instalar transmissão de dupla embraiagem Powershift



1438K/PWR € 468,00 1 014380270
440x400x85 mm - 10 kg

1438DCT/S

kit para alinhar embraiagens duplas a seco Ford

para alinhamento da embraiagem após realizar trabalhos tais como substituição do retentor de óleo da embraiagem



1438DCT/S € 356,00 1 014380305

440x400x85 mm - 8 kg

1439/K7

porta-pontas angular (90°), série longa, com pontas, em caixa



Conteúdo da caixa:
- Porta-pontas angular
- 1 cabeça para parafusos de perfil de fenda
- 1 cabeça 1/4" para pontas
- 1 cabeça especial para pontas
- 7 pontas especiais

1439K7 € 227,00 1 014390101

500x120x60 mm 825 g

1440/...

cintas para segmentos



	Ø mm	L mm	€		
1440/0	40÷75	50	34,00	1	014400000
1440/1	57÷125	80	44,00	1	014400010
1440/1A	57÷125	100	50,50	1	014400011
1440/2	90÷175	80	53,50	1	014400020
1440/2A	90÷175	100	56,50	1	014400021
1440/3	90÷175	165	82,00	1	014400030

1445/1 - 1445/2

grampo para segmentos



	Ø mm	€		
1445/1	50÷100	46,50	1	014450001
1445/2	90÷150	59,50	1	014450002

1452K

compressor de molas de válvulas, com três matrizes

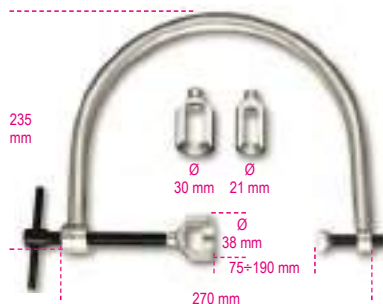

1452K € 177,00 1 014520100

1452PN/K

compressor pneumático para molas de válvulas

Pressão de impulso: 1400 N



Ø mm	L mm	L1 mm	€		
16-19-23	230	185	375,00	1	014520110
25-30-42					

1454P

raspador para remover resíduos de embalagem e selante

Particularmente recomendado para limpeza de cabeças e superfícies planas



L mm	L1 mm	€		
210	32	49,00	1	014540010

1455SVP

rectificador de válvulas pneumático

• Pressão de alimentação: 6 bar



1455SVP € 429,00 1 014550001

1455SVP/R...

ventosas em borracha de substituição para a ref. 1455SVP



	€		
1455SVP/R1	7,70	5	014550501
1455SVP/R2	7,70	5	014550502
1455SVP/R3	7,70	5	014550503

1457/B4

jogo de ferramentas para remover uniões de tubos Rilsan

Tamanhos incluídos:

- 6x8
- 10x12
- 15x16
- 18x1/2



1457/B4 € 57,50 1 014570024

1458

alicate para anéis de segurança



DIN 5417	€		
200 mm	84,00	2	014580001

1460F

alicate para as juntas de afinação das válvulas



1460F € 72,00 1 014600010

1462CF/C6

Jogo de 6 chaves de caixa bi-sextavadas para injectores

Tamanhos:
12-14-16-17-18-19 mm



1462CF/C6 € 112,00 1 014620006

390x145x60 mm - 1,2 kg

1462CF

Jogo de chaves de caixa bi-sextavadas para injectores



mm	€		
12	17,80	1	014620012
14	18,00	1	014620014
16	18,40	1	014620016
17	18,80	1	014620017
19	19,80	1	014620019
18	19,20	1	014620018

1462CF-SN/C6

Conjunto de 6 chaves de caixa sextavadas para injectores

Tamanhos:
12-14-16-17-18-19



1462CF-SN/C6 € 162,00 1 014620026

275x182x64 mm

1462CF-SN

chaves de caixa sextavadas articuladas para injectores



mm	€		
12	28,50	1	014620032
14	29,00	1	014620034
16	30,50	1	014620036
17	31,00	1	014620037
18	31,50	1	014620038
19	33,50	1	014620039

1462/KI

Jogo de extractores de injectores common rail diesel

Permite a remoção de injectores DELPHI-BOSCH-SIEMENS-DENSO



1462/KI € 2.900,00 1 014620235

530x470x140 mm - 2,0 kg

1462/KU

jogo universal para remoção de injectores diesel common rail

Completo com alicate e martelo



1462/KU € 870,00 1 014620100

390x290x100 mm - 4,5 kg

1462/MB

kit para extração de injectores

Inclui:

- 1 4 kg contrapeso com haste 400 mm
- 1 adaptador articulado, macho M10x1,5, fêmea M22x1,5 mm
- 1 adaptador, macho M22x1,5, fêmea M13x1,4 mm
- 1 adaptador, macho M14x1,5, fêmea M27x1 mm
- 1 adaptador, macho M14x1,5, macho M25x1 mm
- 1 adaptador, macho M14x1,5, macho M27x1 mm
- 1 adaptador, macho M14x1,5, fêmea M14x1,5 mm
- 1 adaptador, macho M14x1,5, macho M20x1 mm
- 1 adaptador, macho M14x1,5, macho M17x1 mm



1462/MB € 349,00 1 014620110

500x250x80 mm - 7,2 kg

1462AD/BSC

adaptador para remoção de injectores Bosch common rail

Para utilização com os artigos Beta 960KI e Beta 1462/KU



1462AD/BSC € 252,00 1 014620435

1462AD/SMN

jogo de adaptadores para remoção de injectores Siemens e Denso

Para utilização com o item Beta 960KI/1462KI



1462AD/SMN € 377,00 1 014620436

1462/EI

Ferramenta de vibração universal para extração de injectores

- Facilita a extração total dos injectores mais apertados, sem danificar as cabeças dos cilindros e sem partir os injectores.
- Pode ser utilizado com qualquer outro conjunto de extração de injectores, com ou sem martelo.
- A ferramenta atua diretamente na rosca do injetor, através de vibrações
- A válvula de controlo permite regular a intensidade da vibração.

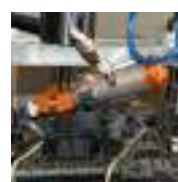

1462/EI € 770,00 1 014620240

Beta
OUTSIDE TOOLS

1463/KIT

kit de fixação da polia da árvore de cames



1463/KIT € 468,00 1 014630001
≡ 280x140x75 mm - 1,2 kg

1464T

Compressómetro digital



Com o kit 960AD/TP2, é possível efectuar os seguintes testes:

- compressão de motores a gasolina e a diesel
- pressão do óleo
- baixa pressão common rail
- pressão de injectores de gasolina

Com o kit 1464AP, é possível efectuar os seguintes testes:

- pressão circuito common rail
- pressão da bomba de alta pressão

ESPECIFICAÇÕES

- Ecrã touch 5"
- Bateria de lítio recarregável com sensor 80 bar (para baixa pressão) e cabo USB

1464T € 1.020,00 1 014640050

1464T/SP80

sensor de pressão, 8 bars, para referências 1464T and 960TP



1464T/SP80 € 350,00 1 014640053

960AD/TP2

jogo de adaptadores para artigo 960TP em caixa plástica



960AD/TP2 € 605,00 1 009600510
≡ 430x310x50 mm - 3,2 kg

1464CBD

jogo de adaptadores para teste de compressão em motores a gasolina e diesel, com compressómetro 1464T

Possibilita a ligação ao motor para testar a compressão de gasolina ou diesel com o dispositivo 1464T

Inclui:

- 8 velas de ignição falsas com válvulas de não-retorno
- 44 velas de incandescência falsas com válvulas de não-retorno
- 1 injetor falso universal ajustável para motores de ligeiros, pesados, embarcações e máquinas agrícolas
- 1 adaptador 90° adapter, válvula de pressão e tubo de ligação
- espaço de arrumação para compressómetro 1464T



1464CBD € 835,00 1 014640300
≡ 510x410x140 mm - 5,5 kg

1464IC

jogo de injectores falsos e velas de incandescência falsas para item 1464T

Permite a ligação ao motor para verificar a compressão em motores a diesel com o compressómetro digital 1464T.

Inclui:

- 22 velas de incandescência falsas
- 5 injectores falsos
- 1 kit injetor falso universal para ligeiros, pesados, motores de embarcações e máquinas agrícolas



1464IC € 685,00 1 014640350
≡ 559x312x50 mm - 4,5 kg

1464IC/RK

kit injectores falsos universais para veículos ligeiros, pesados, motores de embarcações e máquinas agrícolas

fornecido com item 1464IC



1464IC-RK € 221,00 1 014640377
≡ 200x110x30 mm - 885 g

1464AP

Kit para teste do sistema de alta pressão em motores common rail diesel, com artigo 1464T

Equipado com:

- jogo mangueiras de alta pressão
- uniões
- sensor 2,000 bar



1464AP € 920,00 1 014640450
≡ 430x310x50 mm - 1,8 kg

1464AP T

tubo alta pressão para itens 1464AP e 960TAP



1464AP T12X12 € 72,00 1 014640453
1464AP T12X14 € 72,00 1 014640454
1464AP T14X12-M1,0 € 72,00 1 014640455

1464AP T16X12



1464AP T16X12 € 85,50 1 014640456

1464FG

jogo de reguladores falsos para inspeção de sistema common rail diesel (utilização com item Beta 1464T-1464AP)

Utilizado com os adaptadores e dispositivo de teste adequados, possibilita determinar se o problema se encontra na bomba de alta pressão ou no regulador quando não existe pressão no circuito em motores common rail. Recomendado para reguladores de pressão Bosch, Delphi, Denso e Siemens.



1464FG € 356,00 1 014640470

≡ 350x250x80 mm - 1,8 kg

1464FG/CP4

jogo de reguladores falsos para bomba Bosch CP4, não fornecido com o item 1464FG



1464FG/CP4 € 52,00 1 014640475

1464APB

Kit para teste do sistema de alta pressão em motores gasolina FSI, com artigo 1464T

Equipado com sensor 200 bar e conectores



1464APB € 453,00 1 014640500

≡ 240x210x50 mm - 0,5 kg

1464PB

jogo de 9 conectores para teste de baixa pressão de combustível (utilização com item 1464T)

Conectores rápidos para dispositivo de teste 1464T para rápida verificação da baixa pressão do combustível em motores a gasolina e a diesel.



1464PB € 635,00 1 014640700

≡ 530x440x120 mm - 3,8 kg

1464ADB

kit para teste do sistema de pressão AdBlue® para item 1464T

Fornecido com adaptadores para utilização com o sensor padrão de 80 bar fornecido com o item 1464T



1464ADB € 105,00 1 014640620

≡ 240x210x50 mm - 0,5 kg

1464FAP

kit para teste da pressão do filtro de partículas diesel (DPF) para item 1464T

Inclui:

- sensor 500 mbar
- adaptador 8 mm com engate rápido e união em T
- cabo RJ45 com 3m de comprimento



CARACTERÍSTICAS TÉCNICAS
Teste de pressão: 0+500 mbar
Resolução: 1 mbar

1464FAP € 225,00 1 014640610

≡ 240x210x50 mm - 0,5 kg

1464PT

Kit para teste da pressão do turbo, com artigo 1464T

Equipado com sensor e cabo de ligação



1464PT € 198,00 1 014640550

≡ 240x210x50 mm - 380 g

1464TDI

Kit para teste da bomba de pressão em motores TDI, com artigo 1464T

Equipado com conector



1464TDI € 142,00 1 014640600

≡ 240x210x50 mm - 400 g

1464VD

jogo para teste de vácuo para item 1464T

Para medir e armazenar o valor máximo de vácuo
Fornecido com:

- sensor de 800 mbar
- adaptadores de 6 e 8 mm
- Cabo RJ45 de 3 m de comprimento

CARACTERÍSTICAS TÉCNICAS
Teste de vácuo: 0+800 mbar
Resolução: 1 mbar
Armazenamento do valor máximo



1464VD € 225,00 1 014640570

≡ 240x210x50 mm

Beta

1464PF

Kit para testar pressão da bomba de travões, com artigo 1464T

Equipado com adaptadores e conectores



1464PF € 815,00 1 014640650
400x280x60 mm - 3 kg

1465

Teste de compressão do motor

Permite testar compressão endotérmica do motor em apenas alguns segundos, sem necessidade de ligação ao motor, o dispositivo é alimentado pela bateria do veículo, através de um software



Passo 1: cálculo da rotação do motor
Passo 2: testar a evolução da voltagem da bateria durante cada rotação
Passo 3: exibir a potência absorvida e calcular a compressão através do arranque de cada pistão
Passo 4: testar a carga e eficiência da bateria

CARACTERÍSTICAS TÉCNICAS
Voltagem: 12V (bateria do veículo)
Dimensões: 140x75x30 mm
Comprimento do cabo: 1300mm

1465 € 1.370,00 1 014650010

1466/C5

Kit de 5 chaves para extração de líquido de travões

Contém:
• 5 chaves tamanhos 7-8-9-10-11 mm
• 1 tubo de drenagem com válvula de retenção



1466/C5 € 150,00 1 014660100
260x170x50 mm - 600 g

1466L 11

Chave de sangramento dos travões, 11mm versão longa



1466L 11 € 37,00 1 014660211
11 mm L 60 mm

1466TLF

Depósito de recuperação de óleo de travões
Capacidade: 1,5 l

Conectores rápidos para tubo de extração Ø 5.5 mm



1466TLF € 53,50 1 014660201

1467

extractor de líquido de travões



Pressão: min 5 bar, max 11.5 bar

1467 € 398,00 1 014670001

1467/RK1

kit de substituição de tubo para artigo 1467



1467/RK1 € 30,00 1 014670501

1467/RK2

filtro de substituição para artigo 1467



1467/RK2 € 115,00 1 014670502

1467LF/2

instrumento elétrico para substituição do líquido dos travões
com função "efeito pulsante"



• Para automaticamente quando o depósito está vazio, evitando a entrada de ar
• Volume máximo do depósito: 20 l
• Pressão de trabalho: 0.4+3.5 bar
• Alimentação: 230V
Fornecido com:
• Depósito de recolha do óleo dos travões
• 1 adaptador standard E20

1467LF/2 € 2.080,00 1 014670099

1467LF/RC

recipiente com tubo de recuperação de líquido de travões para artigo 1467LF



1467LF RC € 126,00 1 014670125

1467TU

Conector para tanques de recuperação de líquido dos travões

- adaptável a 90% dos modelos de tanque disponíveis
- para utilização conjunta com item Beta 1467LF



1467TU € 78,00 1 014670090

1467T/C6

jogo de conectores para tanques de recuperação de líquido dos travões, para utilização com os itens BETA 1467LF e 1467LF/2

Inclui:

- 1 conector para veículos Toyota
- 1 conector para veículos Ford, Hyundai, Mazda, Mitsubishi, Nissan, Subaru
- 1 conector para veículos Honda
- 1 conector para veículos Mazda e Suzuki
- 1 conector para veículos Nissan
- 1 conector de sangrar travões para veículos europeus



1467T/C6 € 317,00 1 014670080

350x240x85 mm - 1,8 kg

1470

alicate para as molas dos travões de tambor



L mm	€	1	014700001
210	46,50	1	014700001
330	59,50	1	014700002
540	179,00	1	014700010

1470FT

Alicate para as molas dos travões de tambor

Pontas em ângulo de 40°
Acesso fácil a espaços exíguos



L mm 184 € 49,00 1 014700000

1470PF

Ferramenta para substituir cilindros dos travões de tambor

garras permanecem abertas, para fácil substituição do cilindro

38"



Ø 17 mm

A mm 25÷140 € 89,50 1 014700200

1471

alicate para as molas dos travões de tambor



L mm 330 € 90,50 1 014710001

1471A

alicate para cabos de travões de mão



A max mm	B mm	€	2	014710010
45	5	111,00	2	014710010

1471GF

Par de ganchos moldáveis para suporte de pinças de travão para substituição de pastilhas



1471GF Max kg 5 € 16,70 1 014710310



1471M/C22

ferramenta pneumática para rodar e recuar os êmbolos de travões direitos e esquerdos, com acessórios



1471M/C22 € 356,00 1 014710101

350x310x85 mm - 3,5 kg

1471M/50

ferramenta pneumática para rodar e recuar os êmbolos de travões direitos e esquerdos, com acessórios



Ø mm	Kg	Bar	€	1	014710069
50	150	5÷8	196,00	1	014710069

1471M/P

Adaptador de calços e pinças de travão TRW-Mégane



1471M/P € 30,50 1 014710080

1471M/W50

adaptador de travão de mão VW Passat (posterior a 2005)

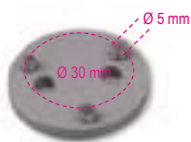

1471M/W50	€ 10,70	1	014710079
-----------	---------	---	-----------

1471PN/B1

adaptador de travão de mão Ford



1471PN/B1	€ 10,70	1	014710081
-----------	---------	---	-----------

1471PN/B2

adaptador de travão Daily

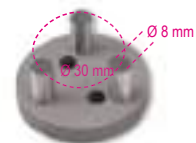

1471PN/B2	€ 14,90	1	014710082
-----------	---------	---	-----------

1471PN/B3

adaptador de travão de mão BMW



1471PN/B3	€ 10,70	1	014710083
-----------	---------	---	-----------

1471PN/B4

adaptador de travão de mão BMW

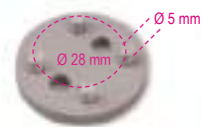

1471PN/B4	€ 10,70	1	014710084
-----------	---------	---	-----------

1471PN/B5

adaptador de travão de mão BMW/Mini

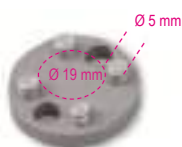

1471PN/B5	€ 9,30	1	014710085
-----------	--------	---	-----------

1471CF

chave de caixa pentagonal para aperto de porcas de pinças de travões



mm	€	1	014710314
14	21,00		
19	21,00	1	014710319

1471CM

chave de caixa pentagonal para aperto de parafusos de pinças de travões



mm	€	1	014710360
10	21,00		

1471CM/E11

Chave de caixa sextavada, 11 mm, para parafusos das pinças de travão Mercedes ML (série 166)



mm	Ø	L	L1	€	1	014710361
11	24	75	15,5	22,20		

1471PT/C5

kit chaves de impacto para porcas de pinças de travão

para automóveis do grupo Volkswagen, Audi & Porsche
• 3 chaves de 10 dentes: 11.5 mm - 15 mm - 20 mm
• 2 chave de 7 dentes: Ø 14 mm - 22 mm



1471PT/C5	€ 85,50	1	014710367
-----------	---------	---	-----------

1471D2

ferramenta para recuar êmbolos dos discos de travões, com pinças fechadas

Dois pares de placas para trabalhar com 2 e 4 pinças



mm	€	1	014710301
10	92,00		

250x170x60 mm 1,5 kg

1471T/C5

5 chaves de pancada para pinças de travões de pesados

podem ser utilizadas com chaves dinamométricas para operações de aperto

tamanhos incluídos:
• chaves Torx fêmea E18, E20, E24
• chaves luneta M24, M26



1471T/C5	€ 295,00	1	014710400
----------	----------	---	-----------

275x220x60 mm - 3,1 kg

1472

alicate para abraçadeiras



1472	€ 52,00	1	014720001
------	---------	---	-----------

1472AU

alicate para abraçadeiras



Ø	€	1	014720100
18=53	152,00		



1472R/AU

pontas de substituição para alicate 1472AU



1472AU/R € 58,50 1 014720101

1472AU/P

alicate com extensão para abraçadeiras de fecho automático



∅ mm 18+54 L mm 630 € 134,00 1 014720105

1472AU/RP

cabo de substituição para alicate 1472AU/P



1472AUP/R € 32,50 1 014720106

1472B/RNLT

chave de caixa dupla, especialmente concebida para abraçadeiras de tubos de sucção instalados em motores do grupo Renault



1472B/RNLT € 21,20 1 014720250

1472FC

alicate para abraçadeiras Clic(R) com cabeça rotativa



1472FC € 48,00 1 014720090

1472FC/GE

alicate para abraçadeiras clic®

Particularmente adequado para abraçadeiras grandes dimensões



L mm 230 € 84,00 1 014720093

1472FC/L

alicate para abraçadeiras Clic® com extensão flexível



L mm 630 € 129,00 1 014720095

1472FCL/RP

cabo de substituição para alicate 1472FC/L



1472FCL/RP € 57,50 1 014720096

1472FCA

Alicate para abraçadeiras tipo Visa®



1472FCA € 72,50 1 014720041

1472H

ferramenta para remover abraçadeiras Henn



L mm 100 € 28,50 1 014720000

1472MT/VW

Par de garras para extração de coletores de aspiração em carros VAG

Podem ser utilizados em motores com turbo a gasolina 1.0 - 1.2 - 1.4



1472MT/VW € 13,80 1 014720500

1472TM

alicate para abraçadeiras de filtros multijet



1472TM € 34,00 1 014720200

1472VW

alicate para abraçadeiras, com cabeça rotativa
Para viaturas Volkswagen e Mercedes



1472 VW € 54,00 1 014720051

1473

alicate para abraçadeiras OETIKER®



1473 275 € 150,00 1 014730001

1473A

alicate para abraçadeiras OETIKER®



1473A € 114,00 1 014730010

1473P

alicate para abraçadeiras OETIKER® de baixo perfil



1473P A Max mm 53 € 42,00 1 014730020

1473FN

alicate para abraçadeiras em aço inox

Para abraçadeiras Panduit(R) e similares



1473FN A mm 4,7-9,5 € 78,00 1 014730501

1473T

Alicate para abraçadeiras em aço

Permite cortar as abraçadeiras sem o risco de causar danos em resguardos, mangas, etc.



1473T A Max mm 14 L mm 220 € 71,00 1 014730582

1474/C4

kit de 4 ferramentas para remoção de bobinas em velas de ignição Volkswagen



1474/C4 € 119,00 1 014740100
290x190x50 mm - 1 kg

1474E/VW

extractor de bobinas de ignição, grupo Volkswagen



1474E/VW € 32,50 1 014740120

1474E/VW2

Extractor de bobinas de ignição, para veículos do grupo VAG para motores 1.0 - 1.2 - 1.4 - 2.0



1474E/VW2 € 40,00 1 014740150

1474L

alicate para cachimbos de velas com bicos longos curvos a 15°

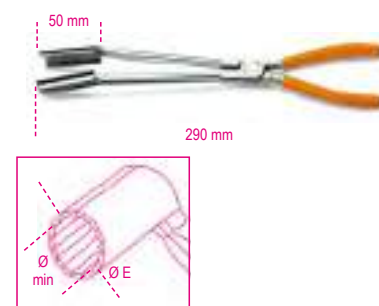

1474L Ø min mm 14 Ø E mm 20 € 95,50 2 014740010

1474DL

alicates longos para cachimbos de velas com punhos de dupla camada em PVC

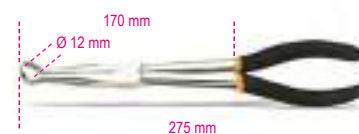

1474DL € 46,00 1 014740015

1474G

Alicate para remover cachimbos de velas de incandescência



1474G € 51,50 1 014740200

1475U

alicate universal cromado brilhante com punho em forma de pistola e dupla camada em PVC

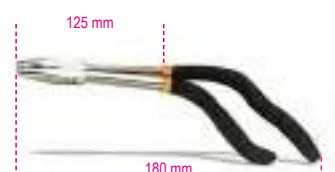

1475U € 48,00 1 014750010

1476

alicate de pressão com corrente para o corte de tubos de escape



Ø min mm	Ø max mm	L mm	€	1	014760002
19	75	225	92,00		

1476/RC

corrente de substituição para refª. 1476



1476RC	€	1	014760012
	45,50		

1476A

alicate com corrente para o corte de tubos de escape



Ø min mm	Ø max mm	€	1	014760005
30	95	117,00		

1476A/RC

corrente de substituição para refª. 1476A



1476A/RC	€	1	014760015
	101,00		

1476C/1

expansor de tubos de escape



1476C/1	€	1	014760101
Ø 30÷42 mm	44,00		

L = 131 mm
L1 = 51 mm

1476GT

alicate para remoção dos apoios em borracha dos tubos de escape



L mm	A Max mm	\pm mm	€	1	014760050
280	58	3	40,50		

1476PSA

alicate para abraçadeiras com pino do circuito de escape, grupo PSA

A forma da ponta e o bloqueio automático da cremalheira possibilitam trabalhar sem extrair o pino



L mm	A Max mm	S mm	€	1	014760060
309	60	12,2	49,50		

1476T

Chave para remoção/instalação de turbinas em motores Volkswagen Audi a diesel

Acesso fácil e rápido à porca sob a turbina



Ø mm	€	1	014760200
12	45,50		

1477/C10

chave de aperto com 9 bits para porcas das polias de correias

1 chave de aperto
4 bits bisetavados: 12x14 - 13x15 - 16x17 - 18x19 mm
5 bits para parafusos Torx®: E10 - E12 - E14 - E16 - E18



1477/C10	€	1	014770310
	192,00		

530x110x55 mm

1477D

chave para aperto de porcas das polias de correias



Ø mm	€	1	014770113
13	34,50		
15	34,50		
16	34,50		
17	34,50		
19	34,50		

1477D/S5

jogo 5 chaves de luneta para porcas de aperto



1477D/S5	€	1	014770200
13-15-16-17-19 mm	172,00		

600x200x70 mm - 2,2 kg

1477K/7

kit com chave de roquete reversível curva e pontas



- 2 pontas TORX T40-T45
- 1 ponta XZN
- 1 ponta hexagonal, 8 mm
- 3 pontas bi-hexagonais, 10-12-13 mm

1477K/7	€	1	014770051
L mm	168,00		
250			

1478

alicate para cavilhas



1478	€	1	014780001
	66,50		

1478NSS

alicate de remoção com pino em plástico com três pontos de desengate



L	mm	€		
180		48,00	1	014780163

1478T

alicate remoção de pinos em plástico com cabeça rotativa e clips de pressão

Cabeça rotativa a 90°

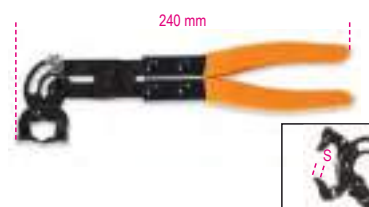

S	mm	€		
4,5		52,00	1	014780101

1478/K3

kit alicates remoção de pinos com sortido clips de plástico

conteúdo do kit:

- alicate de pontas chatas (1 unid.)
- alicate pontas curvas 90° (1 unid.)
- 625 clips de plástico em 16 tamanhos
- clips em 3 caixas PPL empilháveis



L	L1	mm	mm	€		
180	170			121,00	1	014780160

1478SP

sortido de 625 clips de plástico

16 tipos diferentes



€				
29,00	1	014780201		

1479

extractor de cavilhas

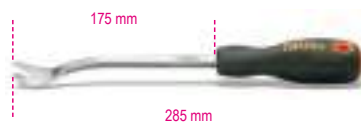

1479	€			
	29,50	2	014790001	

1479/B27

kit 27 ferramentas de nylon para remoção de pinos e trabalhos em plásticos e vedantes, com possibilidade de suspensão



1479/B27	€			
	92,00	1	014790407	

1479LB/C5

Kit de 5 extractores de cavilhas em metal



1479LB/C5	€			
	125,00	1	014790150	

≡ 215x165x50 mm

1479L/S2

Barras de desmontagem, par, Teflon®



1479L/S2	€			
	42,00	1	014790510	

1479LV/S3

Kit de 3 alavancas multiusos em metal

Tamanhos:
1479LV/1: 10x12 mm
1479LV/2: 4.8x9.6 mm
1479LV/3: 2.8x6 mm



1479LV/S3	€			
	35,50	1	014790100	

1479L/K4

4 alavancas multiusos para trabalhos em painéis e peças delicadas



1479L/K4	€			
	40,00	1	014790604	

1479ML/B17

Kit de 17 alavancas multiusos em plástico

Particularmente recomendado para trabalhos de precisão



1479ML/B17	€			
	75,50	1	014790700	

1479ML/S3

Kit 3 alavancas multiusos de plástico

Recomendadas para trabalhos específicos / de precisão



1479ML/S3	€			
	12,90	1	014790603	

1479N/S5

kit de 5 extractores de cavilhas de nylon



1479N/S5 € 47,50 1 014790251

1479RB/1

raspador direito



1479RB/1 € 32,50 1 014790315

1479RB/2

raspador curvo



1479RB/2 € 32,50 1 014790320

1479RB/3

raspador espalmado



1479RB/3 € 37,00 1 014790310

1479U/13

extractor de cavilhas, lâmina em aço inoxidável



1479U/13 € 30,00 2 014790010

1479U/32

extractor de cavilhas, lâmina em aço inoxidável



1479U/32 € 35,50 2 014790015

1480

Kit para enchimento de filtros de óleo diesel sem recurso a bombas eléctricas

• Também para utilização com punhos de encher pneus

Conteúdo:

- uniões rápidas GM
- uniões rápidas Renault, GM, Fiat, Ø interno 6 mm
- uniões rápidas Renault, GM, Fiat, Ø interno 7 mm
- uniões rápidas Ford
- uniões rápidas PSA, Ø interno 6 mm
- uniões rápidas PSA, Ø interno 7 mm
- uniões rápidas Ford
- 2 adaptadores cónicos para veiculos sem uniões rápidas



1480 € 445,00 1 014800010

410x320x70 mm

1481/C12

Kit de 6 pares de grampos para oclusão de tubos

Contém:

- 2 pares de grampos 1/4"
- 2 pares de grampos 3/8"
- 2 pares de grampos 5/16"
- 3 pares de tampas de borracha



1481/C12 € 141,00 1 014810312

370x270x59 mm

1481K/S4

Conjunto de 4 terminais de bloqueio por clampagem

tamanhos: 5/16" - 3/8" - 1/2" esférica



1481K/S4 € 35,50 1 014810400

1481PL/A

grampos para oclusão de tubos

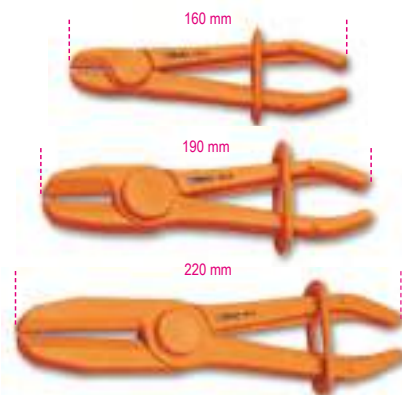

1481PL/A	Ø mm	€	1	014810110
1481PL/B	8÷15	24,10	3	014810120
1481PL/C	15÷25	27,00	3	014810130
	25÷45	36,50	3	014810130

1481PL/S3

jogo de 3 grampos para oclusão de tubos

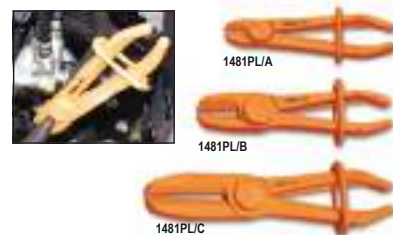

1481PL/S3	€	1	014810200
1481PL-A Ø 8÷15 mm	88,00	1	014810200
1481PL-B Ø 15÷25 mm			
1481PL-C Ø 25÷45 mm			



1481T/C12

jogo tampões para linha de combustível

3 pares de tampões com uniões rápidas macho/fêmea para fechar linhas de combustível



1481T/C12	€ 146,00	1	014810212
≡ 275x220x45 mm - 540 g			

1482

chave para tampas de depósitos de combustível

chave regulável para montagem/desmontagem das tampas dos depósitos de combustível



Ø mm	€		
89÷170	131,00	1	014820001
89÷200	137,00	1	014820002

1482A/1

chave de três pernas para tampas de depósitos de combustível em alumínio

Para porcas de anel em alumínio instaladas em automóveis Fiat, Volkswagen, Opel, Chevrolet, Mercedes e BMW a partir de 2011

Ø 12"



Ø mm	€		
185	90,50	1	014820005

1482A/3

chave para tampas de depósitos de combustível, grupo PSA

Concebida para possibilitar o trabalho em eixos descentralizados, removendo a tampa sem danificar a linha de combustível



Ø mm	€		
157	104,00	1	014820007

1482A/5

Chave para tampas de depósitos de combustível, 22 setores

Para utilização em tampas de plástico de automóveis do grupo VAG

Ø 12"



Ø mm	€		
180	79,50	1	014820015

1482/8 - 1482/10

alicates para ligações rápidas de tubos de combustível

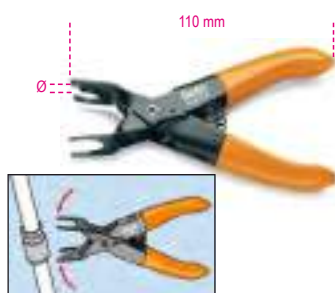

Ø mm	€		
1482/8	8	45,50	2 014820008
1482/10	10	45,50	2 014820010

1482B

alicate para ligações rápidas de tubos de combustível



1482B	€ 54,00	1	014820021
-------	---------	---	-----------

1482SN

alicate giratório de ação rápida para tubos de combustível, com mordentes articulados



L mm	€		
260	69,50	1	014820110

1482C

adaptadores (2 pares) para remoção de uniões de filtros diesel, para os grupos Fiat, Volkswagen, Jeep, Chrysler e Volvo

Rápida substituição do filtro sem danos irreparáveis nas uniões



1482C	€ 72,00	1	014820022
-------	---------	---	-----------

1482D

alicates para ligações rápidas de tubos de combustível, com extensão flexível



1482D	€ 99,00	1	014820026
-------	---------	---	-----------

1483K/12

kit para remoção de válvulas de sistemas de ar condicionado com jogo de bits cabeça em estrela

O kit inclui:

- 2 chaves de caixa fêmea octogonais, Ø 12 e 15 mm, para válvulas de alta pressão
- 2 chaves de caixa macho abertas, secção 2.2 e 3.2 mm, para válvulas "borboleta"
- 1 jogo bits cabeça de estrela, tamanhos: PT10, PT15, PT20, PT25, PT27, PT30, PT40

Ø 14"

Ø 1/4"



1483K/12	€ 47,50	1	014830012
----------	---------	---	-----------

≡ 120x80x35 mm

1483KV-PT/S7

jogo de bits cabeça em estrela

Tamanhos incluídos:

PT10 - PT15 - PT20 - PT25 - PT27 - PT30 - PT40

Ø 14"

Ø 1/4"



1483KV PT/S7	€ 13,70	1	014830117
--------------	---------	---	-----------

1483K/22

Kit separação de uniões em sistemas de ar condicionado, fornecimento de combustível e lubrificação



1483K/22 € 163,00 1 014830022
300x230x55 mm - 1 kg

1484

Jogo 2 ferramentas para remoção e instalação de cintas elásticas

Remoção rápida e instalação correcta de cintas elásticas sem danos



1484 € 145,00 1 014840010

1484PSA

Ferramenta para instalação da correia da bomba de água sem tensor

para veículos do grupo PSA e Opel motores 1.0 - 1.2



1484PSA € 18,90 1 014840012

1485BP

Chave meia-lua para polias dentadas

Pode ser ajustada através do punho (veio roscado), aperta e bloqueia a polia a partir de fora, evitando que os sensores vizinhos fiquem danificados



A Max mm 130 € 258,00 1 014850000

1485BPM

chave meia-lua em alumínio para polias dentadas

Pode ser ajustada através do punho giratório; aperta e bloqueia a polia a partir de fora, evitando danos nos sensores vizinhos



A Max mm 180 € 222,00 1 014850002

1485FCA/K2

ferramentas para pré-carregamento dos rolamentos da correia de distribuição, grupo FcA (par)

Recomendadas para motores 1.2, 1.4 8/16 V e 1.4 Multiair
• 1 ferramenta 175 mm comprimento com hastes de 13.5 mm profundidade
• 1 ferramenta articulada 305 mm comprimento com hastes de 13.5 mm profundidade



1485FCA/K2 € 118,00 1 014850220

1485FCA/T

Tensionador de correia, série longa, com inserts de 13.5 mm



L mm 175 P mm 13,3 € 42,50 1 014850210

1485FCA/TS

Tensionador de correia, articulado, com inserts 13.5 mm inserts



L mm 305 P mm 13,5 € 75,50 1 014850215

1485FRD/T

alavanca para tensionamento de correias em motores Ford

Pode ser utilizada para remover polias de alternador



L mm 450 Q mm 12,80 € 92,00 1 014850310

1485MRC/T

Alavanca de tensão para correias dos motores Mercedes

para motores M133 - M270



L mm 510 Ø T55 € 37,50 1 014850315

1485VLV/T

Alavanca de tensão para correias dos motores Volvo

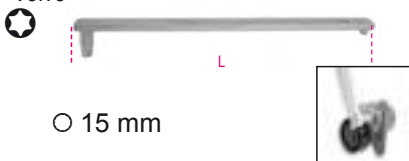

L mm 420 Ø T50-T60 Ø mm 15 € 77,50 1 014850320

1485TC

Alavanca de tensão para correias dos motores Ford, PSA, FCA



L mm 475 € 56,50 1 014850330

1485/KIT

kit para controlar a tensão da correia de distribuição



1485/KIT € 209,00 1 014850100
230x140x75 mm - 580 g



1485MJ

Chave de bloqueio de árvore de cames, para motores 1.3 16V Multijet

2 cabeças de 3 formas para trabalhar em todos os motores Multijet 1.3 16 do grupo de veículos FCA, Opel, Ford e Suzuki



1485MJ	L mm 500	€ 145,00	1	014850150
--------	----------------	-------------	---	-----------

1485PMTJ

alavanca para desmontagem da polia para motores Multijet

Para bloquear o eixo durante a remoção da polia



1485PMTJ	L mm 450	€ 151,00	1	014850190
----------	----------------	-------------	---	-----------

1485R

ferramenta universal para rodar polias da árvore de cames em ferro fundido com 2 pares de ponteiros



1485R	Ø mm 30÷120	Ø1 mm 10 - 17	L mm 500	€ 180,00	1	014850025
-------	-------------------	---------------------	----------------	-------------	---	-----------

1485R/P10

par de parafusos



1485R/P10	€ 19,30	1	014850035
-----------	------------	---	-----------

1485R/P17

par de parafusos



1485R/P17	€ 19,30	1	014850038
-----------	------------	---	-----------

1485VAG/K2

Chaves para os tensores das correias de distribuição, par

- Cabeça giratória em 3 posições
- 1 ferramenta com cabeça de 12,5 mm de profundidade
- 1 ferramenta com cabeça de 21,5 mm de profundidade



1485VAG/K2	€ 89,50	1	014850080
------------	------------	---	-----------

1485VAG

chaves para tensores de correias de distribuição

cabeça giratória em 3 posições



1485VAG/12,5	L mm 190	P mm 12,5	€ 44,00	1	014850062
1485VAG/21,5	L mm 195	P mm 21,5	€ 45,50	1	014850071

1487/K2

2 chaves para bujões de descarga de radiadores



1487/K2	€ 32,00	1	014870100
---------	------------	---	-----------

1488 - 1488L

chave articulada com corrente para filtros de óleo



1488	Ø mm 60÷110	€ 107,00	1	014880001
1488L	Ø mm 60÷160	€ 118,00	1	014880050

1488/1

chave articulada com corrente para filtros de óleo



1488/1	Ø mm 60÷110	€ 124,00	1	014880010
--------	-------------------	-------------	---	-----------

1488R...

corrente de substituição



1488RC	1488	350	€ 44,00	1	014880101
1488R/L	1488/L	520	€ 71,00	1	014880150
1488RC/1	1488/1		€ 61,50	1	014880110

1489/31T

chave para polia de alternador



1489/31T	T50	15	31	€ 45,50	1	014890016
----------	-----	----	----	------------	---	-----------

1489/33

chave para polias de alternadores Bosh



1489/33	33	€ 19,20	1	014890010
---------	----	------------	---	-----------



1489/33P

chave para polias de alternador, para os novos alternadores Bosch FIAT Grande Punto



Ø	mm	mm	€		
M	10	15	31	57,50	1 014890015

1489/E

chave para polia de alternador



Ø	mm	mm	€		
	10	15		38,50	1 014890025

1489R

chave para polias de alternador



1489/R	€		
	19,20	1	014890020

1489/Y

chave para polias de alternador, para alternadores Nippondenso



Ø	mm	€	
	32	22,10	1 014890040

1489/C14

jogo de 14 ferramentas universais para polias do alternador



1489/C14	€		
	343,00	1	014890100

- Ø 867PE 8 mm
- Ø 867PE/L 8 mm
- Ø 867XZN/L M10
- Ø 867TX/L T50
- 867/2 □1/2"
- Ø 920B 10 mm
- 1489/33
- 12 1489/33P M10
- 1489R
- 1489Y
- 1489/31T T50
- 1489/E 10 mm
- 188 10 mm
- 188 15 mm

420x250x45 mm - 1,9 kg

1490

chaves de correia para filtros de óleo

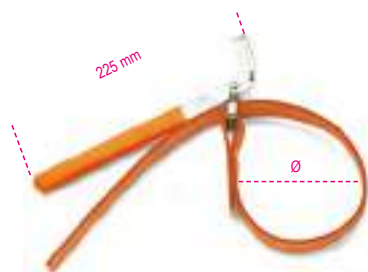

	Ø max	mm	€		
1490/1	160	42,50	1	014900001	
1490/2	240	46,00	1	014900002	

1490/R1 - 1490/R2

faixas de tecido sobresselentes para artigo 1490



	Ø	mm	€		
1490R/1	160	20,80	1	014900101	
1490R/2	240	25,50	1	014900102	

1490F

Chaves de cinta para filtros



Ø Max	mm	€	
200	50	31,00	1 014900201

1491

chave para filtros de óleo com cinta metálica regulável



Ø	mm	€	
65÷110		55,50	2 014910001

1491R

cinta metálica de substituição para ref.^a 1491



1491R	€		
	10,10	10	014910010

1491A

Alicate ajustável para filtros de óleo

Precisão ajustável através de dentado



L	Ø min - Max	mm	€	
345	55 ÷ 140		37,50	1 014910040

1491T

Alicate ajustável para filtro de óleo para pesados

Precisão ajustável através de dentado
Utilização com filtros secos



L	Ø min - Max	mm	€	
500	70÷200		88,00	1 014910050



1492/1 - 1492/2

chaves reguláveis para filtros de óleo



	Ø mm	€		
1492/1	60÷80	52,50	1	014920001
1492/2	80÷110	54,50	1	014920002

1492T

chave para filtros de óleo



	Ø mm	H mm	€		
1492T 40	125÷145	40	40,50	1	014920540
1492T 75	120÷140	75	71,00	1	014920575

1493B

kit chaves bi-sextavadas para filtros de óleo



mm	± mm	€		
24	8	22,70	1	014930524
27	8	23,70	1	014930527
32	8	24,20	1	014930532
36	8	26,00	1	014930536
38	8	26,50	1	014930538

1493B/S5

Kit de 5 chaves bi-sextavadas para filtros de óleo

tamanhos:
24-27-32-36-38 mm



1493B/S5	€		
	94,00	1	014930599

1493

chave para filtros de óleo



Ø mm	N	€		
65	14	12,90	1	014930200
73	14	12,90	1	014930208
74	14	12,90	1	014930209
74	15	12,90	1	014930210
76	14	12,90	1	014930218
76-74	15	14,00	1	014930220
78	15	14,00	1	014930224
80	15	14,30	1	014930226
82-80	15	14,30	1	014930228
86	16	15,20	1	014930230
90	15	15,20	1	014930234
92	10	15,20	1	014930236
93	15	15,20	1	014930238
100	15	17,30	1	014930248
106	15	17,90	1	014930250
108	15	17,90	1	014930252
135	18	29,00	1	014930256

1493/PF

chaves filtro de óleo Purflux®



Ø mm	N	€		
66	6	12,90	1	014930202
76	12	12,90	1	014930216
76	30	14,00	1	014930222
86	18	15,20	1	014930232
93	36	15,20	1	014930240
93	45	15,20	1	014930242
96	18	15,20	1	014930246
108	18	19,30	1	014930254



1493/C30

jogo de 28 chaves para filtros de óleo



Tamanhos incluídos no jogo (Ø mm / n.º. de lados)
1493:
65/14 - 67/14 - 68/14 - 73/14 - 74/15
76/15 - 75.77/15 - 76/14 - 76/8 - 78/15 - 80/15
82/15 - 86/16 - 90/15 - 92/10 - 93/15 - 95/15
100/15 - 106/15 - 108/15

1493PF (Purflux)
66/6 - 76/12 - 76/30 - 86/18
93/36 - 93/45 - 96/18 - 108/18

- Inclui 1 chave ajustável de filtros de óleo
Ø 65÷120 mm

1493/C30	€		
	312,00	1	014930000

≡ 530x400x110 mm - 4 kg

1493AL

chaves de filtro

N= número de lados



Ø mm	N	●	□	€		
64	14	27	1/2"	19,30	1	014930310
66,5	14	27	1/2"	17,30	1	014930315
74	14	27	1/2"	21,00	1	014930320
79	15	27	3/8"	19,30	1	014930325
84	14	27	3/8"	21,00	1	014930330
87	16	27	1/2"	26,00	1	014930335
92	15	27	3/8"	21,00	1	014930340
100,5	15	27	3/8"	21,00	1	014930350

1493AL 4S

chaves de filtro para veículos de origem asiática perfil de 4 ganchos



Ø1 mm	Ø2 mm	€		
70	64,5	27	1	014930304
80	64,5	27	1	014930305

1493AL CF

chaves de caixa sextavadas para cartuchos de filtro



Ø mm	H mm	€	1	014930424
24	34	12,50	1	014930424
30	34	12,50	1	014930430
32,5	34	12,90	1	014930432
36	34	12,90	1	014930436
38	34	12,90	1	014930438

1493/C19

jogo 18 chaves de filtro de óleo, particularmente adequadas para automóveis de origem asiática

Ø mm	Nº. de lados
63-64	14
66.5	14
74	14
79	15
84	14
87	16
92	15
94.5	15
100.5	15
64.5	14 chave de gancho para veículos Toyota
64.5	14 chave de gancho para veículos Lexus
6 chaves de caixa sextavadas, tamanhos 24-27-30-32.5-36-38 mm, para cartuchos de filtro	
Kit inclui 1 chave universal ajustável Ø 58x93 mm	



1493/C19 273,00 1 014930019
490x450x60 mm - 4 kg

1493DSG

chave para filtros de óleo DSG



1493DSG 43,00 1 014930800

1493FF

chave para remover/installar o alojamento em plástico dos filtros de óleo dos motores Ford Peugeot Citroën: TDCi-HDi
Permite o aperto correcto do alojamento em plástico a 25 Nm com chave dinamométrica



1493FF 35,50 1 014930127

1493FT

chave para filtros de óleo Ford Transit Diesel

Pode ser utilizada para todas as versões Transit, Transit Custom e Tourneo Custom fabricadas desde 2012



1493FT 30,00 1 014930085

1493J

chaves para filtros de óleo MultiJet

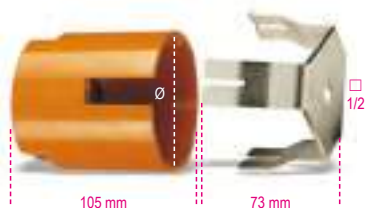

1493J 137,00 1 014930080

1493VW

chave para filtros de óleo diesel, para veículos VAG e Volvo



1493VW 20,00 1 014930086

1493HK

chave para filtros de óleo diesel para Hyundai Kia, 15 faces



1493HK 32,00 1 014930087

1493/C7

chave de filtros de regulação automática com três braços cambiáveis, para aperto à esquerda e à direita

Revestimento diamantado anti-derrapante

- 2 jogos de braços:
- 1 jogo com 20 mm comprimento de trabalho
- 1 jogo com 38 mm comprimento de trabalho



1493/C7 133,00 1 014930079

210x150x50 mm

1493H

Chave de filtro de óleo autoajustável com 3 braços, para aperto à direita e esquerda
Mordentes recartilhados

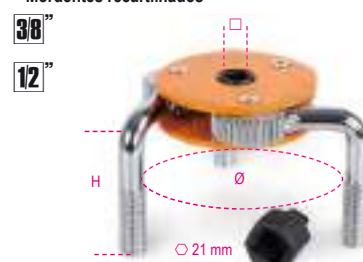

1493H 32,50 1 014930077



1493/S-U

chave de ajuste automático para filtros de óleo com 3 braços, para aperto manual direito e esquerdo



	□	∅	€	🛒	📄
		mm			
1493/S	3/8-1/2	80-115	99,50	1	014930074
1493/U	1/2	105-165	217,00	1	014930076

1493X

chaves de filtro com bloqueio automático, para aperto à esquerda



	∅	±	€	🛒	📄
	mm	mm			
1493X/1	60÷80	2,9	37,50	1	014930105
1493X/2	80÷98	2,9	37,50	1	014930110

1493Y

chaves de filtro com bloqueio automático, para aperto à esquerda e à direita, versão para trabalhos pesados

Item 1493Y/2 também pode ser utilizado para filtros de secado



	∅	±	€	🛒	📄
	mm	mm			
1493Y/1	80÷110	7,3	129,00	1	014930120
1493Y/2	104÷145	7,3	196,00	1	014930122

1493C/ADB

chave para tampas AdBlue®, em veículos do grupo PSA



1493C/ADB	€	🛒	📄
	19,60	1	014930900

1493U/ADB

chave para bujões de drenagem AdBlue®



1493U/ADB	€	🛒	📄
	14,10	1	014930910

1494T/C5

jogo de chaves especiais para bujões de óleo em plástico

Jogo inclui:

- 1 chave para bujões de óleo do grupo VAG
- 1 chave para bujões de óleo BMW
- 1 chave para bujões de óleo grupo PSA e Ford
- 1 chave para bujões de óleo Mercedes
- 1 chave em "T"



1494T/C5	€	🛒	📄
	85,50	1	014940350

≡ 173x125x50 mm - 📦 360 g

1494BMW

chave especial para bujões do cárter, para motores BMW

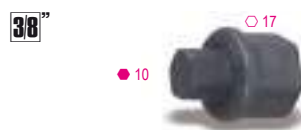

1494BMW	€	🛒	📄
	16,50	1	014940315

1494FPC

chave especial para bujões do cárter, para motores Ford, Peugeot e Citroën



1494FPC	€	🛒	📄
	18,70	1	014940320

1494VW

chave especial para bujões do cárter, motores Volkswagen

Permite remover e instalar o bujão em plástico do cárter de óleo. Especialmente desenvolvido para veículos Volkswagen com motor TFSI e TDI



1494VW	€	🛒	📄
	26,00	1	014940305

1494MRC

chave especial para bujões de óleo em plástico, para motores Mercedes



1494MRC	€	🛒	📄
	18,10	1	014940325

1494MAN

chave especial para bujões de óleo em plástico, para motores DAF e MAN



1494MAN	€	🛒	📄
	18,10	1	014940330

1494

chave quadra para bujões de óleo



1494E

chave macho hexagonal para bujões de óleo



mm	€	🛒	📄
8	10,80	1	014940208
9	10,80	1	014940209
10	10,80	1	014940210
11	10,80	1	014940211
12	10,80	1	014940212
14	10,80	1	014940214
17	10,80	1	014940217



1494Q

chave macho quadra para bujões de óleo



12"



mm	€	U	I
8	10,80	1	014940258
9,5	10,80	1	014940259
12	10,80	1	014940262
13	10,80	1	014940263

1494T

chave macho triangular para bujões



12"



mm	€	U	I
9,5	10,80	1	014940289

1494XZN

chave macho perfil XZN® para bujões de óleo



12"



M	€	U	I
16	12,90	1	014940296

1494VW/K

kit para mudança de óleo, para veículos VAG



Contém:
• 1 chave especial para bujões do cárter
• 6 chaves para cárter de óleo

1494VW/K	€	U	I
	34,00	1	014940310

1494VW/KT

kit de 6 tampas de plástico para item 1494VW/K



1494VW/KT	€	U	I
	29,50	1	014940311

1494/C14A

jogo de 14 ferramentas para muda de óleo

12"



1494/C14A	€	U	I
	154,00	1	014940150

- 1494E 8-9-10-11-12-14-17
- 1494Q 8-9,5(3/8")-12-13
- 1494 10
- △ 1494T 9,5(3/8")
- 1494XZN M16

380x305x40 mm - 1,7 kg

1494M

chave magnética e flexível para bujões sextavados

Permite remover bujões sem risco de queimaduras para o operador



L mm	F kg	Ø mm	€	U	I
293	2,5	19	28,00	1	014940401

1495/C6

jogo de ferramentas para reparação de roscas de bujões de óleo



• A rosca danificada é removida por um macho e aumentada uma medida

• Permite reparar e evitar a substituição do cárter de óleo

Conteúdo:

- 1 macho M13x1.25 + 6 parafusos + 12 anilhas
- 1 macho M13x1.5 + 6 parafusos + 12 anilhas
- 1 macho M15x1.5 + 6 parafusos + 12 anilhas
- 1 macho M17x1.5 + 6 parafusos + 12 anilhas
- 1 macho M20x1.5 + 6 parafusos + 12 anilhas
- 1 macho M22x1.5 + 6 parafusos + 12 anilhas

1495/C6	€	U	I
	334,00	1	014950500

420x185x60 mm - 2,1 kg

1495M

macho para roscas de bujón



M	€	U	I
13x1,25	20,10	1	014950553
13x1,50	16,50	1	014950563
15x1,50	17,90	1	014950565
17x1,50	20,10	1	014950567
20x1,50	22,20	1	014950570
22x1,50	29,00	1	014950572

1495T

jogo 6 bujões e anilhas



M	€	U	I
13x1,25	23,50	1	014950503
13x1,50	23,50	1	014950513
15x1,50	23,50	1	014950515
17x1,50	26,00	1	014950517
20x1,50	29,50	1	014950520
22x1,50	38,00	1	014950522

1496/C

chave para bujões de óleo



8 x 10 mm	€	U	I
	25,50	3	014960010

1497D

Alicate para remoção de relays, pontas direitas

Permite a remoção fácil de todos os tipos de relays, sem o risco de os partir



A min=Max mm	€	U	I
1497D 15÷50	38,50	1	014970150

1497BS

alicates para remoção de relés e fusíveis, pontas direitas, corpo estreito

as pontas longas e extremamente finas permitem remover o relé e o fusível em pequenas áreas

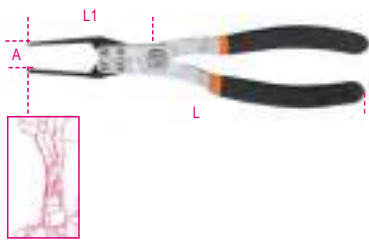

L mm	L1 mm	A mm	€		
230	45	14	27,00	1	014970190

1497P

Alicate para remoção de relays, pontas angulares, 60°

Permite a remoção fácil de todos os tipos de relays, sem o risco de os partir



L	A min+Max mm	€		
1497P	15÷50	40,00	1	014970160

1497SS

alicates de pressão para soldadura de fios estanhados

Os cliques superiores permitem que os fios a soldar sejam presos e aproximados uns dos outros.

A cremalheira incluída permite colocar os fios em 6 posições diferentes



L mm	A min+Max mm	€		
245	14÷70	24,50	1	014970195

1497TE

alicate para conectores elétricos

as extremidades muito finas permitem soltar os clips sem danificar os conectores



L mm	A Max mm	Ø mm	€			
1497TE	215	63	4	28,00	1	014970180

1497/C23

Sortido 23 ferramentas para remoção de terminais eléctricos



1497/C23	€		
	261,00	1	014970200

≡ 440x250x70 mm - 1,7 kg

1497/C94

sortido de 94 conectores de teste auto para utilização com as principais ferramentas de diagnóstico

- 2 machos em T
- 2 potenciômetros
- 2 luzes de aviso
- 2 conectores SRS
- 2 pinças
- 2 sondas de agulha
- 2 pinças para extracção de terminais
- 2 conectores tipo banana duplos
- 4 conectores tipo banana single
- 24 terminais tipo lingueta macho 0.6÷6 mm
- 12 terminais redondos macho 1.6÷3.9 mm
- 24 terminais tipo lingueta fêmea 0.6÷6 mm
- 12 terminais redondos fêmea 1.6÷3.9 mm



1497/C94	€		
	459,00	1	014970300

≡ 430x390x100 mm - 3 kg

1497RC

Pinças para cabos rouba corrente, par

- secção do cabo: 1.5÷3.5 mm
- voltagem: 0÷330V
- corrente máx.: 5A



1497RC	€		
	87,50	1	014970351

1497KB/S3

Kit de 3 ferramentas para remoção de terminais eléctricos Knorr e Bremse

- 1 ferramenta para terminais baioneta
- 1 ferramenta para terminais de 2 polos
- 1 ferramenta dupla para terminais de 4/6/12 polos



1497KB/S3	€		
	96,00	1	014970050

1497/S3

Kit de 3 cabos para deteção de sinal eléctrico

- 1 cabo com terminação direita
- 1 cabo com terminação 45°
- 1 cabo com terminação 90°



1497/S3	€		
	21,60	1	014970400

1498

verificador de tensão

CE

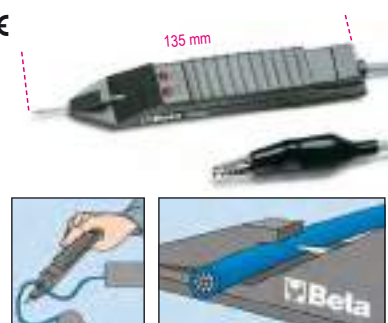

3÷48V	€		
	58,00	2	014980100



REPARAÇÃO DE VEÍCULOS

As nossas ferramentas para reparação de veículos, usadas pelos profissionais mais exigentes, são desenvolvidas e fabricadas para cumprir as normas mais rígidas a nível mundial, e são testadas com regularidade sob as mais difíceis condições de trabalho. Há mais de 50 anos que temos o orgulho de trabalhar de mãos dadas com os melhores, que nos ajudam a melhorar continuamente os nossos produtos e são testemunhas dos mais elevados padrões de qualidade.

As ferramentas de reparação de veículos encontram-se nas seguintes secções:

Diagnóstico	itens 1438 a 1499 itens 1758VT a 1760TMC
Motor	itens 955 a 989A itens 1438 a 1499
Óleo e filtros	itens 1438 a 1499 itens 1877 a 1885
Sistema elétrico	itens 1438 a 1499
Arrancadores	itens 1498BC/12 a 1498/40A
Transmissão	itens 1438 a 1499
Suspensão	itens 1549 a 1569CP
Travões	itens 1438 a 1499
Rodas	itens 955 a 989A
Carroçaria	itens 1302 a 1369 itens 1763 a 1767A
Outros equipamentos	itens 1875LT a 3067
Elevação	itens 3029/2T a 3067/70-13T



1498BC/12

arrancador de baterias portátil multiusos, 12V

Características técnicas:

- Corrente de arranque: 600A
- Pico da corrente de arranque: 1500A
- Tipo de bateria: 4 células, LifePo4
- Capacidade da bateria: 25000mAh
- Dispositivo de proteção contra inversão de polaridade, curto-circuito, sobretensão, sobrecarga e sobreaquecimento



Fornecido com:

- Capa de proteção
- Cabos de arranque com grampos
- Portas USB para carregar dispositivos eletrônicos
- LED indicador de carga da bateria
- Cabo USB e USB-C
- Fonte de alimentação principal
- Lanterna LED multifunções

	L	P	H	€		
	mm	mm	mm			
1498BC/12	225	100	40	382,00	1	014980040

1498MN/12-C

cabos de arranque com grampos para artigo 1498BC/12



	€		
1498MN/12-C	68,50	1	014980005

1498MN/12-R

Dispositivo de alimentação para mini arrancadores 1498BC/12



	€		
1498MN/12-R	50,50	1	014980003

1498MN/12-P

Dispositivo de alimentação para mini arrancadores 1498BC/12



	€		
1498MN/12-P	30,50	1	014980004

1498MN/12-U

Cabos USB com adaptadores universais U



	€		
1498MN/12-U	22,20	1	014980009

1498LT/12

arrancador de baterias portátil de alta performance, ultra leve



Voltagem: 12 V
Amperagem contínua: 800 A
Amperagem máx. de arranque: 2000 A
Pico de amperagem: 4000 A
Comprimento do cabo: 500 mm
Tipo de bateria: 4 células LifePo4
Função de memorização: SIM
Dimensões: 260 x 135 x 72 mm
Peso: 2,5 kg
Com carregador 12 V 1,3A
Proteção eletrônica: SIM

	€		
1498LT/12	975,00	1	014980012

1498LT/12-SF

suporte de parede para arrancador 1498LT/12



	€		
1498LT/12-SF	162,00	1	014980013

1498LT/12-R7

Arrancador portátil alta performance, ultraleve 1498LT/12



	€		
1498LT/12-R7	70,50	1	014980657

1498LT/12-24

arrancador portátil de alta performance,
12-24 V, ultra leve,

adequado para veículos ligeiros, comerciais e
pesados



CE

O microprocessador oferece proteção total contra:

- inversão de polaridade
- curto circuitos
- tensão incorreta
- sobrecargas
- descarga insuficiente
- sobreaquecimento

CARACTERÍSTICAS TÉCNICAS

- voltagem de trabalho: 12/24V
- Amperagem contínua: 2000/1000 A
- amperagem máx. de arranque: 5000/2500 A
- pico de amperagem: 10000/5000 A
- amperagem do grampo: 1000 A
- comprimento do cabo: 160 cm
- secção do cabo: 25mm²
- fonte de alimentação automática: 4 Amp
- função de memória
- dimensões: 350x240x140 mm
- peso: 5 kg

1498LT/12-24 € 1.930,00 1 014980014

1498/12

arrancador de baterias portátil para viaturas,
12V



CE

DADOS TÉCNICOS:

- Pico de corrente de arranque: 2200A
- Alça incluída
- Bateria blindada, electrólito sólido tipo (AGM)

1498/12 € 815,00 1 014980480

13 kg

1498/24

arrancador de baterias
portátil para veículos ligeiros e comerciais,
12-24V



CE

DADOS TÉCNICOS:

- Pico de corrente de arranque: 4200A (12V) - 2100A (24V)
- Alça incluída
- Bateria blindada, electrólito sólido tipo (AGM)

1498/24 € 1.640,00 1 014980490

1498B12/R02

bateria auxiliar 12V
para arrancadores 1498B/12 e 1498B/24



1498B/12-R02 € 354,00 1 014980502

1498/12-24 R20

fonte de alimentação para arrancadores itens
1498/12 e 1498/24



1498/12-24 R20 € 85,50 1 014980520



1498/2A

Carregador eletrónico de baterias de motos,
12V

Permite o carregamento de todos os tipos
de bateria Pb Wet, Agm, Gel, Mf e Vria
e baterias de lítio LiFePo4.



CE

- Dois tipos de carga diferentes, para lítio e bateria de chumbo ácido, respetivamente
- Ciclo de carga automático multi-estágios
- Proteção contra inversão de polaridade e curtos circuitos
- Grau de proteção IP65
- Fornecido com cabo, grampos e cabo com olhais
- Voltagem: 220-240V

CARACTERÍSTICAS TÉCNICAS:

- Corrente de carga: 1A
- Capacidade de carga: 2Ah-40Ah
- Frequência: 50-60 Hz
- Voltagem: 12V
- Dimensões: 180x80x40 mm
- Peso: 0.5 kg

1498/2A € 151,00 1 014980102

1498/4A

carregador de baterias eletrónico para
automóveis/motociclos, 6-12V



CE

- protecção contra inversão de polaridade e curto-circuitos
- seleção automática de 6 ou 12 volt
- seleção automática do tipo de bateria
- monitor digital com iluminação
- gancho de fixação

CARACTERÍSTICAS TÉCNICAS

- Voltagem: 220V-240V
- Frequência: 50-60 Hz
- Corrente nominal (min-max): 1-4 Amp
- Voltagem bateria: 6V/12V
- Capacidade bateria: 4Ah-80Ah
- Tempo de carga: 12 horas
- Grau de protecção: IP65

1498/4A € 183,00 1 014980104

1498SA/2A-4A

Cabo com ligação a isqueiro para os artigos
1498 / 2A e 1498 / 4A



1498SA/2A-4A € 38,00 1 014980120

1498/8A

carregador baterias electrónico para automóveis ligeiros/ligeiros de mercadorias, 12V



- carga rápida e lenta (2A-8A)
- função recuperação da bateria
- função de alimentação 13.8V-5A
- proteção contra inversão de polaridade e curto-circuitos
- seleção manual do tipo de bateria
- monitor digital com iluminação
- gancho de fixação

CARACTERÍSTICAS TÉCNICAS

Voltagem: 220V - 240V
Frequência: 50-60 Hz
Corrente nominal (min-max): 2-8 Amp
Voltagem da bateria: 12V
Capacidade da bateria: 5Ah-160Ah
Função de memorização: 13.8V - 5A
Grau de proteção: IP65

1498/8A € 258,00 1 014980108

1498/4A-8A CO

cabo com olhal para artigos 1498/4A e 8A



1498/4A-8A-CO € 18,50 1 014980114

1498/4A-8A CP

cabo com grampos para artigos 1498/4A e 8A



1498/4A-8A-CP € 23,70 1 014980118

1498/2A-8A-PR

extensão para item 1498/2A/4A/8A



1498/2A-8A-PR € 44,00 1 014980119

1498/16A

carregador de baterias electrónico multiusos, 12-24V



- monitor digital com iluminação
- corrente max. carga: 16A, continua
- carga e manutenção de carga
- proteção contra inversão de polaridade e curto-circuitos
- 9 níveis de carga
- sistema flutuante
- função SHOW ROOM (13.8V - 12A)
- função de alimentação (14V - 12A)
- função de memorização (13.8V - 12A)
- função recuperação de bateria
- suporte para grampos
- gancho de fixação
- acessórios fornecidos: cabo com grampo, cabo com ilhós

CARACTERÍSTICAS TÉCNICAS

Voltagem: 220-240V
Potência: 240W
Corrente de carga: 4-16A
Tipos de bateria: Agm - Wet - Lítio (LiFePo4)
Capacidade de carga: 5-360Ah
Capacidade de manutenção: 5-550Ah
Voltagem de saída: 12-24V
Voltagem mínima da bateria: 0.8V
Grau de proteção: IP20

1498/16A € 545,00 1 014980126

1498/25A

carregador de baterias electrónico multifunções, 12-24V



Características:

- Monitor retroiluminado
- Corrente de carga contínua máx.: 25A
- Carga e manutenção
- Proteção contra inversão de polaridade, curto-circuitos
- 9 estágios de carga
- Sistema de flutuação
- Função SHOW ROOM (13,8V - 21A)
- Função SUPPLY (14V - 21A)
- Função Memória (13.8V - 21A)
- Função recuperação de bateria
- Porta-grampos
- Gancho de fixação reclinável
- Acessórios fornecidos: cabo com grampo

Características técnicas:

- Potência alimentação: 220-240V
- Potência: 390W
- Corrente de carga: 5-25A
- Tipo de bateria: Agm - Wet - Lítio (LiFePo4)
- Capacidade de carga: 5-550Ah
- Capacidade de manutenção: 5-800Ah
- Voltagem saída: 12-24V
- Voltagem mínima da bateria: 0.8V
- Grau de proteção: IP20

1498/25A L mm H mm P mm € 640,00 1 014980125

1498/120A

Carregador de baterias eletrônico multiusos, 12V

Permite carregar baterias e fornecer energia a veículos automóveis durante funções de programação e auto-diagnóstico



- corrente de carga máxima contínua: 120°
- carga e manutenção com microprocessador CPU
- função de recuperação de bateria
- alimentação ECU
- proteção contra inversão de polaridade, curto-circuitos, voltagem incorreta e sobrecarga

Características Técnicas

Alimentação 90-260V
 Potência 1500 W
 Corrente de carga 10-120A
 Tipos de bateria Agm - Wet - Lítio (LiFePo4)
 Capacidade de carga 10-1200Ah
 Capacidade de manutenção 5-3600Ah
 Voltagem de saída 12 Volt
 Comp. cabo, com grampos 2700 mm
 Dimensões 310x150x350 mm
 Peso 8,5 kg

1498/120A € 3.360,00 1 014980142

1498/40A

carregador de baterias / arrancador multiusos, 12-24V com rodas



- 3 ciclos de carga programados e 1 ciclo manual
- potenciômetro eletrônico de regulação
- ciclos de carga específicos WET-SPIRAL/GEL-AGM
- comando eletrônico e sistema de proteção
- processo de carga de 10 níveis
- função de dessulfatação e recuperação de baterias
- função alimentação
- voltagem dupla, 12-24V
- também adequado para baterias Start&Stop
- grampos profissionais em latão com isolamento em borracha

CARACTERÍSTICAS TÉCNICAS

Potência de alimentação: 230V
 Voltagem de saída: 12-24V
 Corrente de carga: 1-40A
 Corrente de arranque: 350A max cc
 Capacidade de carga: 4-450Ah

1498/40A € 1.370,00 1 014980140
 330x250x792

1498SM

bateria auxiliar, 12 V

Evita a perda de informação do computador de bordo durante trabalhos de manutenção ou substituição da bateria.



- Características técnicas:
- auto-alimentada
 - bateria interna Pb 5 Ah
 - 12 volts
 - ligação profissional com tomada OBD

1498SM € 292,00 1 014980020

1498SM-C

União BD II, para segurança da memória de veículos, 12V, para o item 1498SM/C



1498SM-C € 86,50 1 014980021

1498SM-CP

Cabos de arranque com grampos, braçadeira de 12V para o artigo 1498SM/CP



1498SM-CP € 29,50 1 014980022

1498SM-A

Dispositivo USB para o item 1498SM/A



1498SM-A € 32,50 1 014980023

1498TB/6-12

aparelho analógico teste de baterias, 6-12V

para testar baterias de 6V e 12V até 1000CCA



Comp. cabo: 500 mm

1498TB/6-12 € 68,00 1 014980420
 L mm 290 L1 mm 170 P mm 75



1498TB/12-24

teste digital de baterias e sistema de carga/ arranque 12-24 V

- permite realizar testes em: baterias, alternadores (inteligentes e standard) e arrancadores, diodos e chassis
- inclui software para teste de impressão a partir de PC
- display luminoso
- compacto, revestimento antichoque
- software em 10 línguas
- com entrada para ligação a mini-impressora amovível (acessório opcional, Beta 1498ST/TB)



CE

Características Técnicas:

- Aplicações - teste de baterias 12V - teste carga de alternador, 12-24V - teste arrancador
- Intervalo de trabalho 100-2000 CCA
- Normas de referência CCA,SAE,DIN,EN,IEC,JIS
- Baterias compatíveis PB, WET, GEL, AGM, AGM FLAT, EFB
- Voltímetro 9V-36V
- Comprimento do cabo 1600 mm
- Línguas Italiano, Inglês, Francês, Alemão, Espanhol, Polaco, Romeno, Holandês, Sueco e Finlandês
- Acessórios incluídos cabo USB e software
- Peso 1,5 k

1498TB/12-24 € 780,00 1 014980401

1498ST/TB

mini impressora

para aparelho de teste ref. 1498TB/12

- Pode ser directamente ligada ao aparelho de teste
- Permite imprimir os resultados do teste



CE

1498ST/TB € 280,00 1 014980410

1498ST/TB ROT

recarga de papel

para impressora 1498ST/TB



1498ST/TB ROT € 13,60 2 014980411

1498PC

estabilizador de voltagem, 12-24 V

Protege unidades de controlo em processos de soldadura e arranque



1498PC € 116,00 1 014980801

1499

estetoscópio



1499 € 117,00 1 014990001

1500/...

extractores universais com duas pernas



	L mm	€		
1500/1	100	93,00	1	015000301
1500/2	100	97,00	1	015000302
1500/3	150	161,00	1	015000303
1500/4	150	221,00	1	015000304
1500/5	205	402,00	1	015000305
1500/6	205	471,00	1	015000306
1500/7	205	705,00	1	015000307
1500/8	230	1.130,00	1	015000308

	A min+Max mm	A1 min+Max mm
1500/1	25÷80	70÷130
1500/2	25÷130	80÷180
1500/3	50÷160	105÷220
1500/4	60÷200	120÷270
1500/5	80÷250	160÷330
1500/6	80÷350	160÷420
1500/7	110÷520	195÷600
1500/8	170÷640	260÷715



1500/SP5 € 1.040,00 1 015000325
1500/1-1500/2-1500/3
1500/4-1500/5
1500/SPV € 90,50 1 015000001

1500G/...

pernas tipo normal, para artigos 1500 e 1580/81



	mm	1500	€		
1500G/1	35	/1-2	59,50	1	015000311
1500G/3	35	/3-4	88,00	1	015000313
1500G/5	35	/5-6-7	179,00	1	015000315
1500G/8	50	/8	220,00	1	015000317
		1580/81			

1500N/...

extractor universal de 2 pernas



	A min+Max mm	L mm	€		
1500N/0	18÷65	70	83,00	1	015000600
1500N/1	23÷70	100	86,50	1	015000601
1500N/2	23÷100	100	94,00	1	015000602
1500N/3	35÷140	150	156,00	1	015000603
1500N/4	35÷190	150	168,00	1	015000604
1500N/5	43÷250	205	323,00	1	015000605
1500N/6	43÷320	205	350,00	1	015000606



1500N/SP6	€ 910,00	1	015000626
1500N/0-1500N/1-1500N/2-1500N/3			
1500N/4-1500N/5			
1500N/SPV	€ 110,00	1	015000006

1500N/G...

pernas para extractor 1500N



	mm	1500N	€		
1500N/G0	10	/0	27,50	2	015000650
1500N/G1-2	12	/1-2	29,00	2	015000651
1500N/G3-4	17	/3-4	51,50	2	015000653
1500N/G5-6	23	/5-6	101,00	2	015000655

1501/1 - 2 - 3

extractores de pernas finas

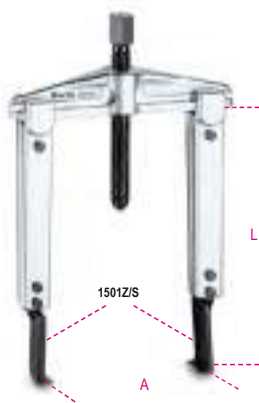

L	mm	€		
1501/1	100	209,00	1	015010101
1501/2	200	221,00	1	015010102
1501/3	250	233,00	1	015010103

A	min+Max	mm
1501/1	25+130	
1501/2	25+130	
1501/3	25+130	



1501G/1 - 2 - 3

pernas para 1501



L	mm	€		
1501G/1	100	115,00	1	015010111
1501G/2	200	134,00	1	015010112
1501G/3	250	145,00	1	015010113

1501Z/S - P - R

terminal para pernas 1501G



	mm	D	mm	€		
1501ZS	2,0	27		41,00	2	015010211
1501ZP	3,6	27		42,00	2	015010212
1501ZR	3,6	14		47,00	2	015010213

1502/...

extrator universal de duas pernas com regulação e fecho rápido

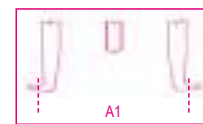

	L	L1	€		
1502/0	100	166	138,00	1	015020000
1502/1	100	166	149,00	1	015020001
1502/2	150	247	237,00	1	015020002
1502/3	150	247	262,00	1	015020003
1502/4	200	321	449,00	1	015020004

	A	A1
	min+Max	min+Max
	mm	mm
1502/0	40+90	80+130
1502/1	50+130	90+170
1502/2	65+150	115+210
1502/3	65+190	125+260
1502/4	70+235	170+335

1505V

extrator do braço limpa pára-brisas dianteiro e traseiro

Ponta de bronze perfurada amovível para extracção do braço, com jacto de água



	A Max	L	€		
	mm	mm			
1505V	43	37	51,00	1	015050001



1505/C5

kit extractores do braço limpa pára-brisas

1 extractor de 2 pernas, Ø 25+40 mm
4 chaves curvas, Ø 25 mm, Ø 30 mm, Ø 35 mm, Ø 41 mm



mm 12 € 171,00 1 015050300

320x150x60 mm - 1,2 kg

1506

extractor de duas pernas com aperto automático

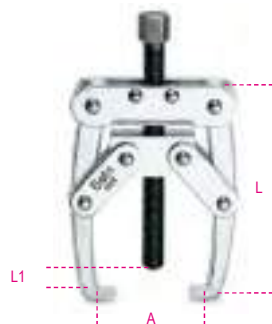

	A min=Max mm	L mm	L1 mm	€		
1506	10÷50	80	40	49,50	1	015060001

1508/1 - 1508/2

extractores de duas pernas, série ligeira



	L mm	€		
1508/1	105	166,00	1	015080001
1508/2	130	198,00	1	015080002

	A min=Max mm	L1 mm
1508/1	6÷100	85
1508/2	10÷140	120

1511/1 - 2 - 3

extractores exteriores com duas pernas reversíveis

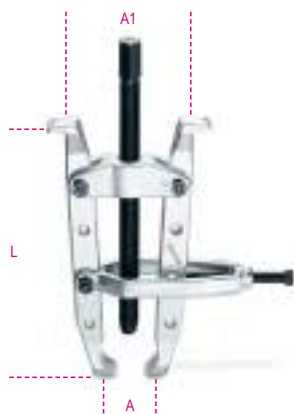

	L mm	€		
1511/1	235	282,00	1	015110001
1511/2	330	352,00	1	015110002
1511/3	405	437,00	1	015110003

	A min=Max mm	A1 min=Max mm
1511/1	20÷100	65÷95
1511/2	40÷150	103÷190
1511/3	40÷150	103÷175

1515/1 - 2 - 3

extractores com duas pernas oscilantes



	L mm	€		
1515/1	85	37,00	1	015150101
1515/2	85	39,00	1	015150102
1515/3	105	58,50	1	015150103

	A Max mm	L1 mm
1515/1	60	105
1515/2	70	105
1515/3	90	105

1516/1 - 2 - 3

extractor com três pernas oscilantes



	L mm	€		
1516/1	85	53,50	1	015160001
1516/2	85	57,00	1	015160002
1516/3	105	81,00	1	015160003

	A Max mm	L1 mm
1516/1	60	85
1516/2	70	85
1516/3	90	105

1517

extractor de 3 pernas com bloqueio automático

- Para maiores cargas de extração.
- Efeito autoblocante



	L mm	L1 mm	Ø mm	€		
1517/90	182	60	22	289,00	1	015170000
1517/150	242	115	22	296,00	1	015170010
1517/200	307	150	22	342,00	1	015170020
1517/260	395	180	30	397,00	1	015170030

	● mm	A mm	kg	N
1517/90	19	18÷90	6000	59000
1517/150	19	25÷150	6000	59000
1517/200	19	40÷200	6000	59000
1517/260	27	50÷260	8000	78500



1517C

EXTRATORES COMBINADOS DE DUAS/TRÊS PERNAS COM APERTO AUTOMÁTICO, PARA UTILIZAÇÃO EXTERNA

O extrator Beta 1517C possui um mecanismo de aperto automático das pernas acionado pela mola da cruzeta. Esta característica facilita o posicionamento e bloqueio do extrator no componente a remover. Após fixar o extrator, as pernas podem ser bloqueadas através da porca.

A cruzeta especial possui 4 apoios que permitem a utilização do extrator 1517C com 2 pernas – para trabalhos mais rápidos e fáceis – e com 3 pernas – para maior firmeza.

O pino da cabeça do parafuso quebra se o aperto máximo permitido for excedido, protegendo o extrator de sobrecargas.

1517C/...

extratores combinados de duas/três pernas com aperto automático

- para utilização com 2- ou 3 pernas
- aperto automático



	L mm	L1 mm	€	U	U
1517C/0	145	250	245,00	1	015170500
1517C/1	200	300	300,00	1	015170501
1517C/2	270	300	373,00	1	015170502

	A mm	● mm
1517C/0	12÷140	18
1517C/1	20÷180	18
1517C/2	30÷280	18

1518/...

extratores com três pernas



	L mm	€	U	U
1518/1	105	89,50	1	015180001
1518/2	135	115,00	1	015180002
1518/3	235	203,00	1	015180003
1518/4	270	301,00	1	015180004
1518/5	270	354,00	1	015180005
1518/6	270	371,00	1	015180006

	A min÷Max mm	L1 mm
1518/1	24÷100	105
1518/2	32÷160	150
1518/3	40÷220	220
1518/4	80÷250	240
1518/5	80÷300	350
1518/6	80÷350	400

1518U/...

extratores universais de três pernas

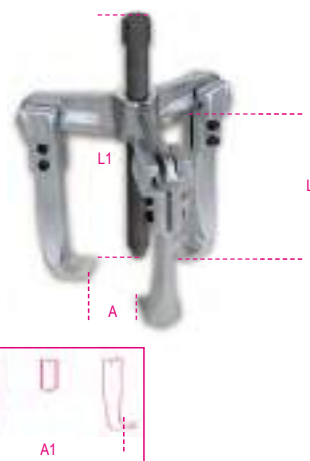

	L mm	L1 mm	€	U	U
1518U/0	100	166	169,00	1	015180500
1518U/1	100	166	181,00	1	015180501
1518U/2	150	247	275,00	1	015180502
1518U/3	150	247	287,00	1	015180503
1518U/4	200	321	414,00	1	015180504

	A min÷Max mm	A1 min÷Max mm	● mm
1518U/0	40÷90	80÷130	17
1518U/1	50÷130	90÷170	17
1518U/2	65÷150	115÷210	22
1518U/3	65÷190	125÷260	22
1518U/4	70÷235	170÷335	27

1519/...

extratores universais de três pernas com regulação e aperto rápido

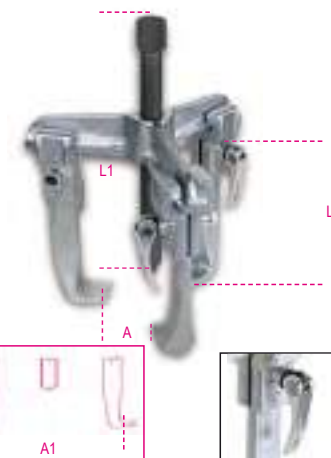

	L mm	L1 mm	€	U	U
1519/0	100	166	195,00	1	015190000
1519/1	100	166	207,00	1	015190001
1519/2	150	247	295,00	1	015190002
1519/3	150	247	313,00	1	015190003

	A min÷Max mm	A1 min÷Max mm	● mm
1519/0	40÷90	80÷130	17
1519/1	50÷130	90÷170	17
1519/2	65÷150	115÷210	22
1519/3	65÷190	125÷260	22



1520/1 - 1520/2

extractores
com duas pernas reversíveis

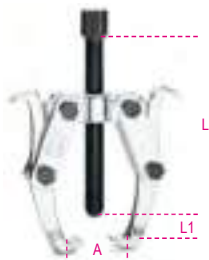

	L mm	€		
1520/1	135	85,00	1	015200101
1520/2	235	145,00	1	015200102

	A Max mm	L1 mm
1520/1	110	85
1520/2	160	140

1521/1 - 1521/2

extractores
com três pernas reversíveis



	L mm	€		
1521/1	135	110,00	1	015210101
1521/2	235	193,00	1	015210102

	A Max mm	L1 mm
1521/1	110	90
1521/2	160	140

1528

Extrator de aperto automático para discos de travão



∅ 19 mm

	A min+Max mm	€		
170÷380		207,00	1	015280000

260x240x60 mm - 4,8 kg

1529

extractor multi-passos para polias cónicas

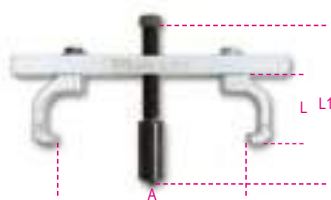

A	L	L1	€		
min+Max mm	min+Max mm	min+Max mm			
24÷240	60÷95	90÷135	302,00	1	015290000

260x210x60 mm - 2,6 kg

1529/C7

kit extractores de polia

Contém:

- extrator de 2 pernas com 2 pés 4.7 mm espessura
 - extrator de 2 pernas com 1 pé 4.3 mm espessura
 - extrator de 1 perna com 2 pés 2.3 mm espessura
 - extrator de 1 perna com 1 pé 2.3 mm espessura
- O par de pernas pode ser constituído de acordo com as necessidades do trabalho

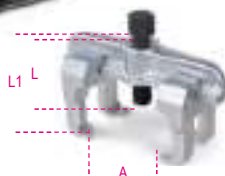

L	L1	A	€		
mm	mm	min+Max mm			
1529/C7	50 72,5	53÷114	177,00	1	015290100

285x155x50 mm - 2 kg

1529PI

extractor de polia da bomba injectora

- remoção rápida e precisa da polia de injeção de combustível
- particularmente adequado para veículos Fiat, Ford, Volkswagen, Citroën e Peugeot

Inclui 3 parafusos para fixar o extrator na polia:

M6 x 1.0 x 49 mm

M7 x 1.0 x 75 mm

M8 x 1.25 x 76 mm



	€		
1529PI	126,00	1	015290051

1529/PG

Extrator de bomba de combustível de alta pressão, para veículos do grupo VAG



∅ mm	€		
15-24	77,50	1	015290010

1530/C5

Kit extractores dos cubos das rodas e rolamentos,
3, 4, 5 orifícios

Contúdo:

1 flange universal (96÷138 mm)

1 parafuso hidráulico (12 t)

1 batente para martelo (2.8 kg), necessário para cubos sem parafusos de fixação centrais



	€		
1530/C5	640,00	1	015300300

760x320x120 mm - 11,5 kg

1530/C16

kit para extração de cubos de rodas e rolamentos, com prato, 3, 4, 5 furos

Ideal para cubos de rodas com anéis centrais projetados

Inclui:

- 1 flange universal (90÷130 mm)
- 1 contra-peso (5 kg)
- 4 parafusos M12
- 4 parafusos M14



	€		
1530/C16	785,00	1	015300316

760x310x100 mm - 13,5 kg

1531/C7

kit extrator para anéis de rolamentos cubos de rodas

Inclui:

- 1 alicate Ø 40+45 mm
- 1 alicate Ø 45+51 mm
- 1 alicate Ø 50+55 mm
- 1 alicate Ø 55+61 mm



1531/C7 € 860,00 1 015310107

390x315x96 mm - 4,3 kg

1532

extrator de juntas



1532 € 20,00 2 015320001

1533/...

forças para separadores refª. 1534



L mm	€		
1533/2 150	124,00	1	015330002
1533/3 210	235,00	1	015330003
1533/4 315	372,00	1	015330004
1533/5A 305	449,00	1	015330006

A min=Max mm	L1 mm
1533/2 45÷140	110
1533/3 55÷205	175
1533/4 90÷260	175
1533/5A 100÷360	235

1533PR/1 - 2 - 3

extensões para forças refª. 1533



	€		
1533PR/1 1533/2	27,00	1	015330011
1533PR/2 1533/3	29,00	1	015330012
1533PR/3 1533/4	30,50	1	015330013
1533PR/5A 1533/5A	30,50	1	015330016

1534/...

separadores

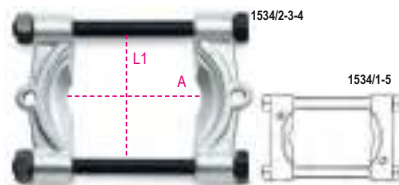

		€		
1534/1 1533/2	108,00	1	015340001	
1534/2 1533/2	127,00	1	015340002	
1534/3 1533/3	211,00	1	015340003	
1534/4 1533/4	354,00	1	015340004	
1534/5A 1533/5A	730,00	1	015340006	

	A min=Max mm	L1 mm
1534/1	5÷60	63
1534/2	12÷75	75
1534/3	22÷115	118
1534/4	25÷155	154
1534/5A	30÷220	180

1535/C...

jogos de forças e separadores



1535/C1 € 344,00 1 015350001

	€		
1533/2			
1533PR/1			
1534/1			

260x180x40 mm - 2,5 kg

1535/C2 € 364,00 1 015350002

	€		
1533/2			
1533PR/1			
1534/2			

260x180x40 mm - 2,8 kg

1535/C3 € 600,00 1 015350003

	€		
1533/3			
1533PR/2			
1534/3			

380x280x55 mm - 8,0 kg

1535/C4 € 925,00 1 015350004

	€		
1533/4			
1533PR/3			
1534/4			

420x380x65 mm - 14,8 kg

1535/C5A € 1.400,00 1 015350006

	€		
1533/5A			

530x510x85 mm - 27,2 kg

1539

extrator de percussão para chapa



1539 € 198,00 1 015390001

1540

extrator de percussão

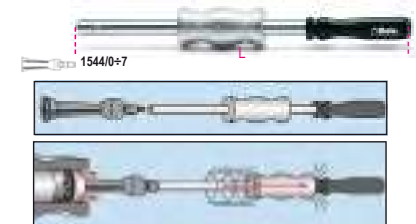

1540 € 105,00 1 015400001



1542/1 - 1542/2

extractores de duas pernas para expansores



	A	min+Max	1544	€	📦	📄
	mm	mm	0÷7		1	015420001
1542/1	35÷75	0÷7		90,50		
1542/2	60÷130	9C-10C		137,00		1 015420002

	L	L1
	mm	mm
1542/1	140	140
1542/2	175	160

1544/...

pinças de expansão para interiores

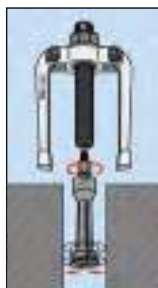

	C	Ø	€	📦	📄
	mm	M		1	
1544/0	0,25	M10	80,00		1 015440100
A= 5÷7					
1544/A	0,80	M10	83,00		1 015440105
A= 7÷9					
1544/1	0,80	M10	85,00		1 015440110
A= 9÷12					
1544/2	1,15	M10	87,00		1 015440120
A= 13÷17					
1544/2B	1,00	M10	89,00		1 015440121
A= 14÷19					
1544/3	1,70	M10	92,00		1 015440130
A= 16÷21					
1544/4	1,65	M10	102,00		1 015440140
A= 20÷25					
1544/5	2,00	M10	109,00		1 015440150
A= 25÷30					
1544/6	3,00	M10	137,00		1 015440160
A= 30÷37					
1544/7	3,80	M10	155,00		1 015440170
A= 38÷45					
1544/9C	2,60	G 3/8"	224,00		1 015440189
A= 40÷75					
1544/10C	7,30	G 3/8"	309,00		1 015440199
A= 70÷115					

1545/C5M

extractor ref.º. 1542/1 com 5 expansores da ref.º. 1544



1545/C5M	€ 610,00	📦 1	📄 015450011
----------	----------	-----	-------------

1542/1	● 24 mm
1544/1	9+12 mm
1544/2	13+17 mm
1544/3	16+21 mm
1544/4	20+25 mm
1544/5	25+30 mm

📏 265x180x45 mm - 📦 2,4 kg

1547/C6

extractor de rolamentos de esferas



1547/C6	€ 312,00	📦 1	📄 015470006
---------	----------	-----	-------------

📏 420x185x60 mm - 📦 3 kg

1547/KP

jogo de 3 pares de terminais redondos falsos



	Ø	€	📦	📄
	mm		1	
1547KP/1	9-11-12,5	49,00		1 015470106
1547KP/2	5-6-8	34,00		1 015470206

1547P

extensões hexagonais



	L	mm	€	📦	📄
1547P/1	205	1547/1	10,70	1	015470101
1547P/2	102	1547/2	6,80	1	015470201

1547PC/2

extensões redondas, série curta



	L	mm	€	📦	📄
1547PC/2	42	1547/2	5,50	1	015470202

1547PL/2

extensões redondas, série longa

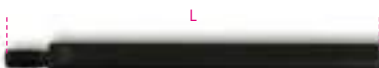

	L	mm	€	📦	📄
1547PL/2	106	1547/2	6,20	1	015470203

1549

kit para remoção e instalação de amortecedores de duplo efeito a gás

Permite manter a haste direita ao instalar as molas



1549	€ 453,00	📦 1	📄 015490001
------	----------	-----	-------------

📏 310x270x110 mm - 📦 3 kg



1550U

pressa pneumática para molas de amortecedores de automóveis, carrinhas e veículos comerciais

CE

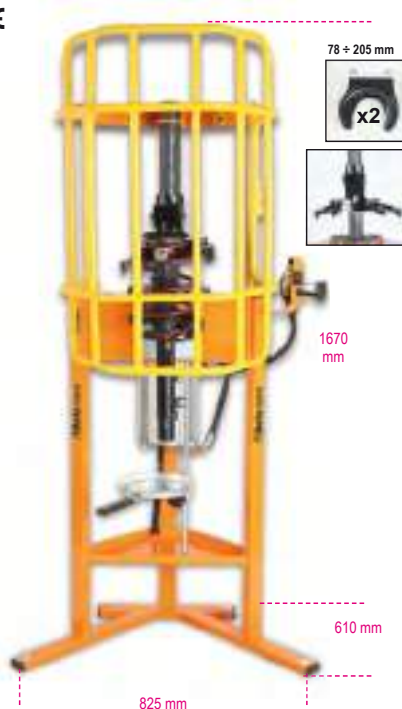

MAIOR POTÊNCIA: pressão máxima 2 toneladas (10 bars)
SISTEMA DE FIXAÇÃO SUPERIOR UNIVERSAL: permite a compressão de todos os diâmetros de mola esq./dir. com um prato superior adaptável
SISTEMA DE SEGURANÇA ATIVO NA MOLA: gancho de segurança e 3 válvulas de bloqueio permitem o posicionamento correto da mola, mantendo a posição durante a compressão. Se a mola não estiver na posição correta, o sistema imobiliza a máquina
GRELHA DE PROTEÇÃO: máxima segurança e cobertura da área de trabalho
ALAVANCA DE COMANDO: maior precisão e sensibilidade durante a compressão
POSIÇÃO DE TRABALHO: altura de trabalho no garfo posterior elevado até 875 mm

Fornecido com 2 garfos inferiores para diâm. 78-205 mm

CARACTERÍSTICAS TÉCNICAS

Pressão máxima:

2 toneladas (10 bars) - 1.6 toneladas (8 bars) - 1.2 toneladas (6 bars)

Curso compressão da mola: 335 mm

1550U € 3.450,00 1 015500010

1550U/CGS-R

Garfos superiores rebaixados, para item 1550U



1550U/CGS-R € 665,00 1 015500035

1550U/MRC-ABE

garfos especiais para artigo 1550U, especialmente concebidos para veículos Mercedes classe A-B-E



1550U/MRC-ABE € 685,00 1 015500031

1550U/MRC-C

garfos especiais para artigo 1550U, especialmente concebidos para veículos Mercedes classe C



1550U/MRC-C € 605,00 1 015500032

1550U/S...

forquilha para artigo 1550U



	Ø mm	€		
1550U/S 130	78+130 mm	435,00	1	015500014
1550U/S 182	105+182 mm	435,00	1	015500015
1550U/S 205	125+205 mm	435,00	1	015500016

1550U/SS187

garfo esquerdo para item 1550U

Particularmente adequado para molas esquerdas, por ex. em: Nissan Qashqai e Renault Koleos



1550U/SS 187 € 435,00 1 015500018

1550U/M

torno para ferramenta remoção de amortecedores 1550U

Permite bloquear a haste do amortecedor



1550U/M € 414,00 1 015500021

1551/C20

Kit de ferramentas para extração das cabeças dos amortecedores

Inclui:

- 7 chaves de caixa sextavadas: 16 - 17 - 18 - 19 - 21 - 22 - 24
- 1 extensão para chave de caixa 120 mm
- 3 bits fêmea de fenda: 8x5 - 8x6 - 11x8
- 1 bit fêmea sextavada 10 mm
- 1 bit macho XZN(R) M10
- 1 bit macho Torx(R) T50
- 4 bits machos sextavadas: 5- 6 - 7 - 8
- 1 extensão para porta-bits 95 mm
- 1 extensão para porta-bits 190 mm



1551/C20 € 183,00 1 015510020

320x245x71 mm - 2,6 kg

1552/C9

Kit de desmontagem dos amortecedores e dos braços de suspensão e direção

possível utilizar em versão simples ou dupla para desmontagem dos braços de suspensão e direção duplos de veículos do grupo VAG



1552/C9 € 145,00 1 015520020

195x140x40 mm - 1,0 kg



1555/Q

compressor para molas de amortecedores MacPherson e equivalentes
Impulso máx.: 1500 kg

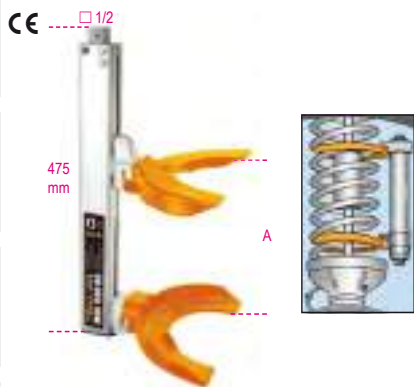

A	∅	€	1	015550006
min+Max mm	min+Max mm			
65+354	80+195	945,00		

1555/QS

compressor para molas de amortecedores tipo MacPherson e equivalente



A	∅	€	1	015550005
min+Max mm	min+Max mm			
70+300	80+200	1.160,00		

1555S/BMW-RNT

forquilha para BMW E39, amortecedores E46 e Renault Mégane II, para artigos 1555DS e 1555/QS



1555S/BMW-RNT	€	1	015550303
	365,00		

1555C

compressor telescópico para molas de amortecedores com 4 matrizes e barra de torção



A	∅	N	t	€	1	015550202
min+Max mm	min+Max mm					
80+225	90+160	25000	8,5	1.120,00		

1556/1A

compressores de molas de amortecedores

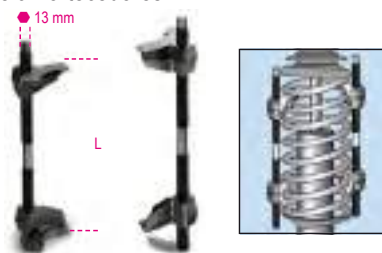

min L Max	€	1	015560101
mm			
65+320	272,00		

1556/2A

compressores de molas de amortecedores

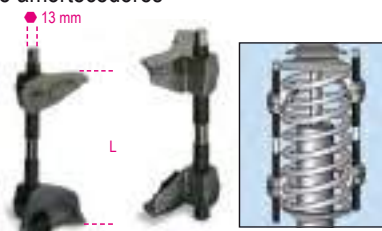

min L Max	€	1	015560102
mm			
65+200	269,00		

1557

chave de caixa para casquilhos de amortecedores de camião



L	L1	€	1	015570137
mm	mm			
37	28	101,00		
46	34	104,00		
56	34	112,00		

1557V

chaves de caixa para casquilhos de amortecedores Volvo



mm	€	1	015570299
27	52,50		

1557/S3

jogo de 3 chaves para casquilhos de amortecedores



1557/S3	€	1	015570010
	78,50		

1558/C4

ferramenta para anel retentor interno e externo, operada por parafuso

Encabadoiro quadrado permite a aplicação de uma força elevada em ambas as condições de operação
Pontas fornecidas:
∅ 2.5-3-3.5 mm



1558/C4	€	1	015580100
5,5÷77 5,5÷77	195,00		
330x220x50 mm - 900 g			

1558P

Par de pontas para anéis de retenção para artigo 1558



∅ mm	€	1	015580125
2,5	9,90		
3,0	9,90		
3,5	9,90		

1558/C13

Ferramenta para anel retentor interno e externo, operada por parafuso

Encabadoiro quadrado permite a aplicação de uma força elevada em ambas as condições de operação

Pontas fornecidas:
• direita: ∅ 2.5 - 3 - 3.5 - 3.8 mm
• 45°: ∅ 2.5 - 3 - 3.5 - 3.8 mm
• 90°: ∅ 2.5 - 3 - 3.5 - 3.8 mm



1558/C13	€	1	015580200
5,5÷77 5,5÷77	260,00		
330x220x45 mm - 1,6 kg			

1559

extractor se rótulas tipo ligeiro



	A Max mm	Ø mm	€		
1559/22	50	18÷22	101,00	1	015590001
1559/36	90	36	462,00	1	015590036
1559/45	115	45	695,00	1	015590045

1559V/8T

parafuso hidráulico para extractores de rótulas 1559/36 e 1559/45

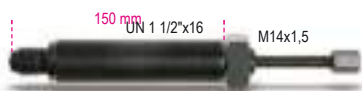

Nm	t	€		
80000	8	349,00	1	015590145

1560/2

extractor de rótulas modelo profissional



	A min+Max mm	Ø mm	€		
1560/2	60÷85	20	215,00	1	015600002

1560A

extractor de rótulas



	€		
1560A	288,00	1	015600601

1561/...

extractor de rótulas



	L mm	A mm	Ø mm	€		
1561/1	39	36,6	18	78,00	1	015610001
1561/2	47	45,7	25	102,00	1	015610002
1561/3	63	62	30	149,00	1	015610003
1561/4	75	63	40	189,00	1	015610004

1562D

extractor de rótulas

Fornecido com 2 parafusos para extracção de rótulas da suspensão e da direcção



A max mm	Ø mm	● mm	L mm	€		
50	39	26	155	392,00	1	015620239

1563/C4

jogo de 4 chaves extratoras de juntas esféricas

para utilização com martelo pneumático

o jogo inclui:

- 1 chave M12x1.25 mm
- 1 chave M12x1.5 mm
- 1 chave M14x1.5 mm
- 1 chave M16x1.5 mm



	€		
1563/C4	56,50	1	015630010

1565/1-2-3

extractor de rótulas por percussão



	Ø mm	L1 mm	€		
1565/1	18	65	89,00	1	015650001
1565/2	23	65	101,00	1	015650002
1565/3	30	88	105,00	1	015650003

1566N

ferramenta para remoção/instalação de braços de direcção



Ø x L mm	○ mm	□ mm	€		
28÷35 x 400	27	12"	142,00	1	015660005
35÷45 x 190	27	-	142,00	1	015660008
35÷45 x 400	27	12"	160,00	1	015660010

1566R

ferramenta ajustável para remoção/instalação de braços de direcção



Ø mm	€		
27÷43	27,00	1	015660015

1566/G01

extractor de rótulas homocinético

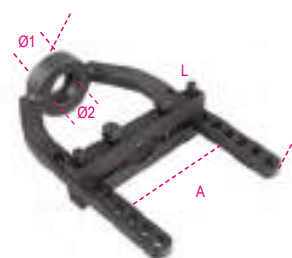

L mm	A mm	Ø1 mm	Ø2 mm	€		
250	115	29	36	169,00	1	015660052

1566P

alicate de freios para veios estriados

O alicate comprime o circlip, facilitando o encaixe do veio do eixo na junta homocinética



L mm	A Max mm	€		
280	36	77,00	1	015660091

1567

alavanca para extracção do terminal do braço oscilante da suspensão e dos amortecedores

Utilização apenas por um operador



A mm	B min+Max mm	€		
1060	100÷300	389,00	1	015670001

1568

pinça pneumática para foles

8 braços extensores

extensão máxima do braço: 145 mm

CE



L mm	L1 mm	€	🔧	📦
420	195	277,00	1	015680001

1569/F

jogo ferramentas para remoção e inserção de sinoblocos em Fiat Panda, Fiat 500 e Ford Ka



1569/F	€	🔧	📦
	515,00	1	015690021

1569/SB

jogo de ferramentas para extração e colocação de sino-blocos no eixo traseiro, vedantes de óleo do eixo de direcção e rolamentos das rodas

• possibilidade de utilização dos casquilhos no veículo ou na prensa hidráulica



1569/SB	€	🔧	📦
	287,00	1	015690016

425x365x100 mm - 13 kg

1569CP

chave de pancada para instalação de rolamentos cónicos e vedantes

Ajuste rápido



	Ø min+Max mm	L mm	€	🔧	📦
1569CP/50	9,5+50	130	152,00	1	015690750
1569CP/90	18+90	145	189,00	1	015690790

1570/3

pressas hidráulicas para extractores



t	L mm	L1 mm	• mm	€	🔧	📦
30	243	36	19	265,00	1	015700003

1580/8I

extractor hidráulico universal com duas pernas

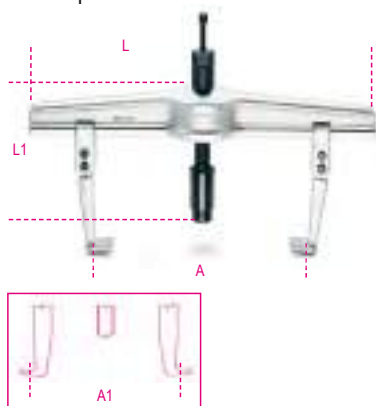

1580/8I	€	🔧	📦
	1.700,00	1	015800008

	A min+Max mm	L mm	L1 mm	A1 min+Max mm	N Max
1580/8I	170+640	715	280	260+715	180000

1580GL

pernas soltas, série longa, para extractores 1580/8I



	L mm	€	🔧	📦
1580GL/8A	300	192,00	1	015800227
1580GL/8B	400	214,00	1	015800228
1580GL/8C	500	273,00	1	015800229

1585/5I - 6I - 7I

extractores hidráulicos de três pernas



	€	🔧	📦
1585/5I	1.180,00	1	015850005
1585/6I	1.250,00	1	015850006
1585/7I	1.280,00	1	015850007

	A min+Max mm	L1 mm	L mm	N Max
1585/5I	50+350	135	280	150000
1585/6I	50+350	235	280	150000
1585/7I	50+350	335	280	150000

1585GI/5 - 6 - 7

pernas para extractor hidráulico refª. 1585/I-1585/6I-1585/7I



	L mm	€	🔧	📦
1585GI/5	135	108,00	1	015850205
1585GI/6	235	127,00	1	015850206
1585GI/7	335	154,00	1	015850207

1589VI

fuso hidráulico para extractores 1580/8I e 1585/5I-1585/6I-1585/7I



1589VI	€	🔧	📦
	700,00	1	015890001

1589PI/50 - 100 - 150

extensão para fuso hidráulico



	L mm	L1 mm	€	🔧	📦
1589PI/50	50	70	63,50	1	015890005
1589PI/100	100	120	69,50	1	015890010
1589PI/150	150	170	76,00	1	015890015

1590

extensão para fuso hidráulico



A max mm	L1 mm	€	🔧	📄
60	55	30,50	2	015900305
100	65	49,00	2	015900310
150	95	81,50	2	015900315

1591

grampos de carpinteiro



A ~	A max mm	L1 mm	€	🔧	📄
200	200	80	32,00	2	015910020
300	310	85	39,50	2	015910030
400	410	85	42,50	2	015910040
500	500	95	57,50	2	015910050
600	600	95	58,50	2	015910060
800	800	95	71,00	2	015910080
1000	1000	110	89,00	2	015910100

1593

grampos com fuso



A ~	A max mm	L1 mm	€	🔧	📄
160	170	80	38,00	2	015930016
200	240	100	58,50	2	015930020
300	320	145	82,00	2	015930030

1594

grampos com alavanca

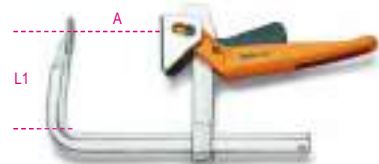

A ~	A max mm	L1 mm	€	🔧	📄
200	240	145	127,00	1	015940020
250	290	145	132,00	1	015940025
300	340	145	142,00	1	015940030
400	430	150	148,00	1	015940040
500	530	150	156,00	1	015940050
600	630	150	163,00	1	015940060

1595

grampos com fuso

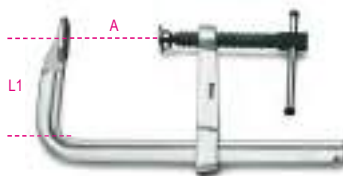

A ~	A max mm	L1 mm	€	🔧	📄
200	230	100	60,50	2	015950020
250	270	120	66,00	2	015950025
300	330	120	84,00	2	015950030
400	420	120	94,50	2	015950040
500	520	125	103,00	2	015950050
600	620	125	109,00	2	015950060
800	820	125	129,00	1	015950080
1000	1030	125	143,00	1	015950100

1599F

tornos paralelos de bancada, forjados

Totalmente fundido em aço. Superfície do mordente fresada e endurecida. Abertura frontal. Profundidade de aperto elevada.



L1 mm	BxH mm	Ø mm	A MAX mm	€	🔧	📄
100	92x46	11	125	377,00	1	015990100
125	108x54	13	150	481,00	1	015990125
150	125x62	13	200	675,00	1	015990150
175	140x70	15	220	925,00	1	015990175

1599GI

torno de bancada com mordentes intercambiáveis

- com guia quadrada para trabalhos pesados
- mordentes intercambiáveis com superfície reforçada



L1 mm	BxH mm	Ø mm	A MAX mm	€	🔧	📄
100	92x46	11	125	290,00	1	015990200
125	108x54	13	150	399,00	1	015990225
150	125x62	13	200	545,00	1	015990250
175	140x70	15	220	730,00	1	015990275

1599GR

pares de mordentes e parafusos sobresselentes para torno 1599GI



	A mm	€	🔧	📄
1599GR 100	100	28,00	1	015990920
1599GR 125	125	35,00	1	015990925
1599GR 150	150	42,50	1	015990950
1599GR 175	175	49,50	1	015990975

1599P

tornos de bancada paralelos

Mordentes endurecidos. Bigorna com grande superfície lacada. Base quadrada em aço.

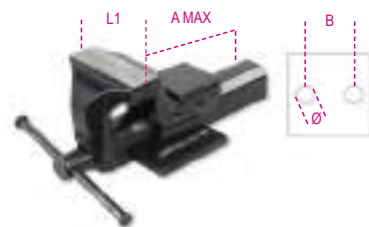

L1 mm	B mm	Ø mm	A MAX mm	€	🔧	📄
100	92	11	111	331,00	1	015990000
125	108	13	130	397,00	1	015990025
150	130	15	170	555,00	1	015990050

1599B

bases rotativas para artigo 1599P



	1599P	€	🔧	📄
1599B 100	100	138,00	1	015990810
1599B 125	125	157,00	1	015990812
1599B 150	150	195,00	1	015990815

1599T

tornos para engenhos de furar de coluna

Tornos especiais em ferro fundido, com mordentes temperados e retificados.

Para engenhos de furar de coluna de pequenas e médias dimensões



L1 mm	B mm	Ø mm	A MAX mm	€	🔧	📄
80	111	11	65	187,00	1	015990480
100	120	13	87	232,00	1	015990500

1599G

par de coberturas para mordentes em alumínio

- magnéticas em todo o seu comprimento
- interior estriado para fixação de peças roscadas



A mm	€	1	015990910
100	60,50	1	015990910
125	63,00	1	015990912
150	69,00	1	015990915
180	76,50	1	015990917

1600Q 8

chave de 4 bocas para operadores de painéis de controlo.

- quadrada 6 / 7-8 mm
- triangular 7 / 9 mm
- ponta dupla 3-5 mm
- sextavada 1/4"
- fenda 1.0x7 mm + cruz PH2



L mm	€	1	016000008
76	34,00	1	016000008

1600Q 10

Chave de 8 bocas, com junta articulada, para operadores de painéis de controlo.

- quadrada 5 / 6-7 / 8-9 mm
- triangular 5-6-7 / 8-9 / 10 mm
- ponta dupla 3-5 mm
- hexagonal 1/4"
- quadra macho 1/4"



L mm	€	1	016000010
125	43,00	1	016000010

SERVIÇO DE CERTIFICAÇÃO PARA INSTRUMENTOS DE MEDIÇÃO

A certificação de instrumentos de medição é essencial nos setores ou campos de aplicação em que são essenciais medições precisas, inequívocas e perceptíveis.

A certificação envolve a emissão de um certificado Accredia:

A Beta Utensili S.p.A. fornece o serviço de certificação, a pedido, para Paquímetros, Paquímetros Digitais, Medidores, Micrómetros e Apalpa Folgas. Para requerer este serviço, contacte o seu revendedor.



1650

paquímetro leitura vigesimal



UNI EN ISO 13385-1DIN 862

A max mm	L mm	€	1	016500001
150	235	67,00	1	016500001
200	290	88,00	1	016500002

1650FD

paquímetro para discos de travões, leitura decimal

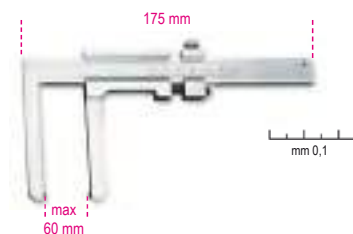

1650FD	€	1	016500050
	250,00	1	016500050

1650FT

paquímetro para tambores de travões, leitura vigesimal



	A max mm	L mm	€	1	016500060
1650FT/1	350	438	468,00	1	016500060
1650FT/2	500	550	820,00	1	016500070

1651DGTB

vernier digital, leitura até 0.01 mm

Características:

- leitura até 0.01 mm
- bloqueio parafuso deslizante
- conversão mm/polegadas
- regulação a zero em qualquer posição
- haste de profundidade quadrada até 300 mm
- em estojo de plástico rígido

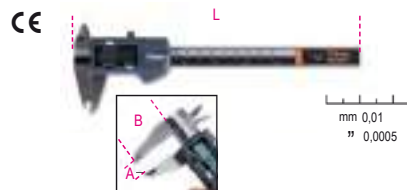

UNI EN ISO 13385-1DIN 862CE

A Max mm	L mm	B mm	€	1	016510211
150	235	40	113,00	1	016510211
200	285	50	147,00	1	016510212
300	400	60	192,00	1	016510213

Beta

1651DGTB/IP

vernier digital,
leitura até 0.01 mm,
grau de proteção IP67

- leitura até 0.01 mm
- bloqueio parafuso deslizante
- conversão mm/polegadas
- acionamento automático movimentando o vernier ao longo da escala
- regulação a zero em qualquer posição
- função FIXAR
- medição em modo absoluto e gradual

Grau IP67 proporciona total proteção contra poeiras e líquidos, mantendo as características funcionais do vernier, por ex., quando se encontra totalmente submerso.

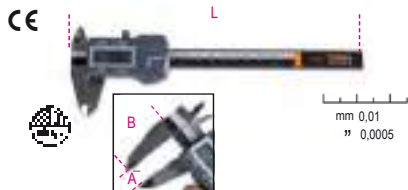

UNI EN ISO 13385-1 DIN 862CE

A Max mm	L mm	B mm	€		
150	235	40	185,00	1	016510711

270x115x35 mm - 450 g

1652

paquímetro analógico
leitura analógica quinquagesimal



UNI EN ISO 13385-1DIN 862

1652	€	142,00	1	016520016
------	---	--------	---	-----------

1654

paquímetro leitura quinquagesimal



UNI EN ISO 13385-1DIN 862

A max mm	L mm	€		
200	330	310,00	1	016540020
300	410	420,00	1	016540030

Beta

1654DGT

paquímetro digital,
leitura até 0.01 mm
leitura até 0.0005"

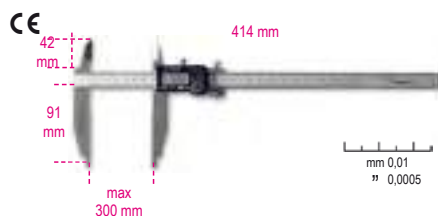

UNI EN ISO 13385-1DIN 862CE

1654DGT	€	710,00	1	016540111
---------	---	--------	---	-----------

1656

paquímetro de profundidade
com ponta leitura vigesimal



UNI EN ISO 13385-2DIN 862

A max mm	L mm	€		
200	260	147,00	1	016560020
300	360	216,00	1	016560030

1657DGT/2

paquímetro digital de profundidade
leitura centesimal

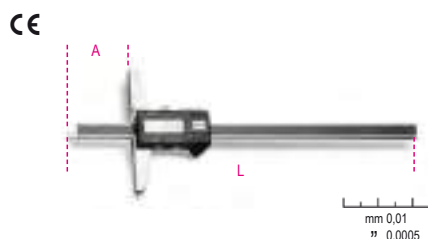

UNI EN ISO 13385-2DIN 862CE

A max mm	L mm	€		
1657DGT/2	200	274,00	1	016570002

1658/...

micrômetros para exteriores
leitura centesimal



DIN 863/II

	A mm	€		
1658/25	0÷25	84,50	1	016580025
1658/50	25÷50	92,00	1	016580050
1658/75	50÷75	104,00	1	016580075
1658/100	75÷100	114,00	1	016580100

1658/C4

jogo de 4 micrômetros modelo 1658



DIN 863

1658/C4	€	340,00	1	016580001
---------	---	--------	---	-----------

1658/25	0÷25 mm
1658/50	25÷50 mm
1658/75	50÷75 mm
1658/100	75÷100 mm

365x245x35 mm - 2,5 kg

1658DGTB

micrômetro digital exterior IP65, leitura até 0.001 mm

- leitura até 0.001 mm
- calibres em aço reforçado
- bloqueio da alavanca deslizante
- conversão mm/polegadas
- regulação a zero em qualquer posição
- medição em modo absoluto e gradual
- fornecido com chave de calibragem



DIN 863CE

1658DGTB 25	€	231,00	1	016580525
1658DGTB 50		287,00	1	016580550

Beta

Beta

1658SP/1

suporte para micrômetro



1658SP/1 € 58,50 1 016580910

1659

medidor de espessura com comparador leitura centesimal

C = campo de comparação



1659 C mm 0=10 € 217,00 1 016590001

1662/1 - 1662/2

comparador leitura centesimal

C = campo de comparação



DIN 878
1662/1 C mm 0=5 € 99,50 1 016620001
1662/2 C mm 0=10 € 122,00 1 016620010

1662DGT/A

comparador digital, leitor para 0.01 mm

C = Campo de leitura



1662DGT/A C mm 0-12,5 € 301,00 1 016620311

1662AN

comparador analógico, com ponteira orientável, leitura até 0.01 mm

Campo de leitura



DIN 2270
1662AN C mm 0=0,8 € 235,00 1 016620200

1662SPO

base magnética



1662SPO € 84,00 1 016620800

1662SP2

suporte com base magnética articulado



1662SP2 € 152,00 1 016620910

1666

esquadro simples em aço inoxidável retificado e polido



DIN 875/0
L mm L1 mm € 1 016660210
100 70 69,00 1 016660215
150 100 100,00 1 016660220
200 130 120,00 1 016660225
250 165 155,00 1 016660230
300 200 195,00 1 016660230

1666A

esquadro de cepo em aço inoxidável retificado e polido



DIN 875/0
L mm L1 mm € 1 016660110
100 70 101,00 1 016660115
150 100 137,00 1 016660120
200 130 193,00 1 016660125
250 170 239,00 1 016660130
300 200 303,00 1 016660130

1668

esquadro de cepo em aço normalizado retificado



DIN 875/2
L mm L1 mm € 2 016680210
100 70 30,50 2 016680215
150 100 40,50 2 016680220
200 130 53,00 2 016680225
250 165 77,00 1 016680230
300 174 94,50 1 016680230



1668A

esquadro de cepo
em aço normalizado rectificad



DIN 875/2

L mm	L1 mm	€		
100	70	36,00	2	016680110
150	100	56,00	2	016680115
200	130	71,00	2	016680120
250	165	102,00	1	016680125
300	176	122,00	1	016680130

1670

esquadros de precisão
em aço rectificad



L mm	L1 mm	€		
100	70	19,00	3	016700010
150	100	19,80	3	016700015
200	130	22,30	3	016700020
250	160	24,40	3	016700025
300	175	27,00	3	016700030
400	230	40,00	2	016700040
500	280	44,50	2	016700050
600	330	47,00	2	016700060
800	420	64,50	1	016700080
1000	500	77,00	1	016700099

1670A

esquadros de cepo
em aço rectificad



L mm	L1 mm	€		
100	70	24,90	3	016700110
150	100	27,00	3	016700115
200	130	29,00	3	016700120
250	165	35,00	3	016700125
300	175	41,50	3	016700130
400	230	54,50	2	016700140
500	280	72,50	2	016700150
600	330	81,50	2	016700160
800	420	96,50	1	016700180
1000	500	120,00	1	016700199

1672

suta corrediça lâmina e base em aço

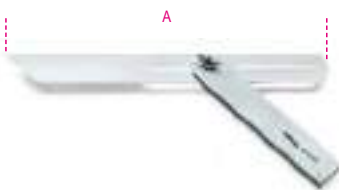

A mm	€		
300	58,00	2	016720030

1672A

suta corrediça com lâmina em aço cromado
e base em alumínio

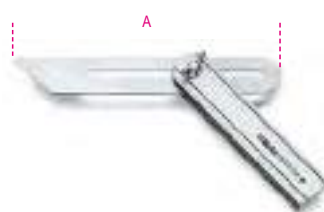

A mm	€		
200	30,00	3	016720120
300	33,00	3	016720130

1674A

esquadros para marceneiro
lâmina em aço base em alumínio,
dupla escala milimétrica



L mm	L1 mm	€		
300	169	28,50	2	016740130
400	214	35,50	2	016740140

1674C

esquadro para marceneiro com lâmina em aço
e nível de superfície

- Escala dupla mm
- Nível de superfície



L mm	€		
300	20,80	2	016740230

1676

goniômetros simples
em aço inoxidável

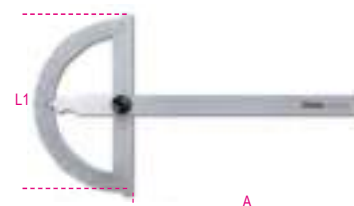

A mm	A mm	L1 mm	G mm	€		
120	120	80	1°	45,00	2	016760012
150	165	120	1°	52,00	2	016760015
200	210	150	1°	63,00	2	016760020
300	310	200	1°	84,50	1	016760030

1678/C3

transferidor de ângulos
em aço inoxidável



L Max mm	D mm	€		
300	70	321,00	1	016780030

1679

paquímetro de traçagem com rolete
em aço inoxidável, leitura decimal

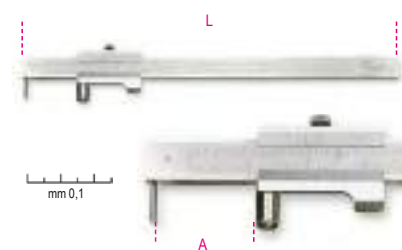

L mm	A Max mm	€		
235	200	97,00	1	016790020

1679/PR

ponta sobresselente para manómetro
universal 1679



L mm	€		
300	15,70	1	016790021

1680

compassos de vara corpo e pontas de traçagem em aço temperado

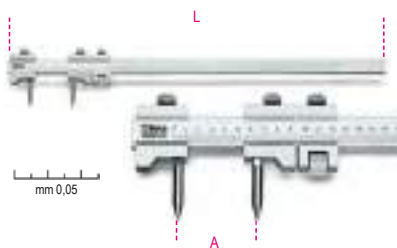

L mm	A Max mm	€	U	IT
660	500	321,00	1	016800050

1680A

compassos de precisão para interiores



L mm	A Max mm	€	U	IT
150	144	20,90	2	016800115
200	200	25,50	2	016800120
250	245	31,50	1	016800125
300	300	36,00	1	016800130

1680B

compassos de precisão para exteriores



L mm	A Max mm	€	U	IT
150	155	20,90	2	016800215
200	190	25,50	2	016800220
250	235	31,50	1	016800225
300	280	36,00	1	016800230

1680C

compassos de precisão para traçagem pontas direitas em aço temperado



L mm	A Max mm	€	U	IT
150	138	20,90	2	016800315
200	190	25,50	2	016800320
250	235	31,50	1	016800325
300	280	36,00	1	016800330

1682

régua graduada flexíveis em aço inoxidável

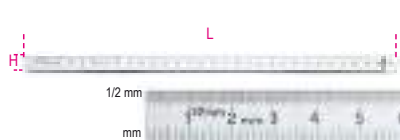

L mm	H mm	± mm	€	U	IT
150	13	0,5	3,40	5	016820015
200	13	0,5	3,65	5	016820020
250	13	0,5	4,60	5	016820025
300	13	0,5	5,70	5	016820030
500	13	0,5	12,90	2	016820050
1000	13	0,5	33,50	2	016820100

1683

régua graduada semi-rígidas em aço inoxidável

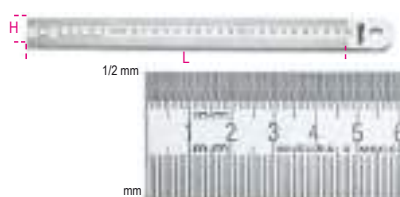

L mm	H mm	± mm	€	U	IT
300	30	1	10,10	5	016830030
500	30	1	16,90	2	016830050
1000	30	1	42,50	2	016830100
1500	30	1	95,00	1	016830150

1685/C7

jogo de 7 ferramentas para medir e traçar



1685/C7	€	U	IT
	326,00	1	016850110

	1650	160 mm
	1658/25	0+25 mm
	1670	100 mm
	1680C	150 mm
	1682	150 mm
	1688BC	165 mm
	1688BC/R	

320x210x37 mm - 1,2 kg

1687A

riscador com punho para mecânico, tipo curvo a 90°

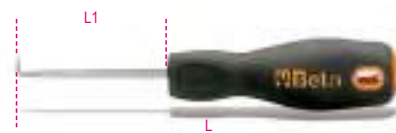

1687A	L mm	L1 mm	€	U	IT
	153	80	7,10	1	016870120

1687AC

riscador com punho para mecânico, tipo curva curta a 90°



1687AC	L mm	L1 mm	€	U	IT
	153	80	7,10	1	016870125

1687D

riscador com punho para mecânico, tipo direito



1687D	L mm	L1 mm	€	U	IT
	153	80	7,10	1	016870110

1687U

riscador com punho para mecânico, tipo gancho



1687U	L mm	L1 mm	€	U	IT
	153	80	7,10	1	016870115

1687/S4

jogo de 4 riscadores com punho para mecânico



1687/S4	€	U	IT
1687A-1687AC 1687D-1687U	28,50	1	016870150

1688

riscador em aço temperado



1688	L mm	Ø mm	€	5	016880020
	250	2	9,40		

1688A

riscador em aço temperado,
extremidade em carbonato de tungstênio



1688A	L mm	Ø mm	€	5	016880120
	200	4	16,90		

1688PC

riscador
em aço temperado, com acabamento cromado



1688PC	L mm	Ø mm	€	1	016880300
	150	1	40,00		

1688PC/R

ponta de substituição para artigo 1688PC



1688PC/R	€	1	016880310
	11,70		

1688M

lápiz



1688M	L mm	€	50	016880880
	180	1,28		

1690F

fita métrica feita de fibra de vidro, classe III

CE



1690F/2	L m	S mm	€	5	016900220
	2	17	13,50		

1690L

fita métrica feita de vidro flexível, classe III

CE



1690L/2	L m	S mm	€	5	016900200
	2	17	14,70		

1691BM

fita métrica
revestimento ABS de dois componentes
resistentes ao choque,
fita em aço,
precisão classe II

CE



1691BM/5	L m	S mm	€	1	016910205
	5	25	17,60		
1691BM/8	L m	S mm	€	1	016910208
	8	32	26,50		
1691BM/10	L m	S mm	€	1	016910210
	10	32	32,00		

1691MG

fitas métricas com ímãs fixos,
caixas ABS anti-impacto,
fitas em aço,
classe de precisão: II

CE



1691MG/5	L m	S mm	€	1	016910405
	5	25	15,90		
1691MG/8	L m	S mm	€	1	016910408
	8	25	22,20		
1691MG/10	L m	S mm	€	1	016910410
	10	25	23,40		

1692

fitas métricas,
caixa em ABS anti-choque,
fitas em aço,
classe de precisão II

CE



1692/2	L m	S mm	€	5	016920052
	2	16	8,60		
1692/3	L m	S mm	€	5	016920053
	3	16	10,70		
1692/5	L m	S mm	€	5	016920055
	5	19	15,30		
1692/8	L m	S mm	€	5	016920058
	8	25	22,00		

1693

Medidor de distância laser, 20 metros

MEDIÇÕES:

- medição de distância única
- medição contínua ou medição mínima

Função desligar (off) automática

Autonomia: até 4,000 medições

CE
IP54



DADOS TÉCNICOS:

Amplitude de medição: 0.05 + 20 m (0.2ft + 66ft)

Unidades de medida: m, in, ft

Precisão de medição: ±1.5 mm (± 0.06 in)

Classe de laser: 2

Pilhas: AAA 2 x 1.5V

1693 20	H mm	L mm	S mm	€	1	016930020
	100	36	23	135,00		

1693L

medidor de distâncias a laser, multifunções,
40 m,
com níveis de posicionamento

MEDIÇÕES:

- medição de distância simples
- medição contínua ou medição mínima

FUNÇÕES:

- adição/subtração
- medição de área
- medição de volume
- medição indireta de variável (medição de Pitágoras)
- medição de inclinação

acionamento automático desligado

duração da bateria: até 5.000 medições

estojo em tecido suave (incluído)

CE
IP54



Características técnicas:

• Intervalo de medição: 0.05 + 40 m (0.2in + 131f)

• Seleção da escala: m, in, ft

• Precisão de medição: ±1.5 mm (± 0.06 in)

• Classe de laser: 2

• Armaz. máx.: 99 unidades

• Pilhas: AAA 2 x 1.5V

1693L 40	H mm	L mm	S mm	€	1	016930040
	115	50	25	164,00		

1693M

Medidor de distância laser, multiusos, 80 m

- MEDIÇÕES:**
- medição de distância
 - medição contínua ou medição mínima
- FUNÇÕES:**
- adição/subtração
 - medição de área
 - medição de volume
 - medição indireta (função Pitágoras)
 - medição de inclinação

Função desligar (off) automática
Bolsa de pano (incluída)
Autonomia: até 4,000 medições



DADOS TÉCNICOS:
Amplitude de medição: 0.05 + 80 m (0.2 ft + 229f)
Unidades de medida: m, in, ft
Precisão de medição: ±1.5 mm (± 0.06 in)
Classe de laser: 2
Memória: 99 unidades
Pilhas: AAA 2 x 1.5V

	H mm	L mm	S mm	€	U	IC
1693M 80	115	48	29	230,00	1	016930080

1694/L

fitas métricas longas caixa em ABS anti-choque, fita em fibra de vidro revestida a PVC, classe de precisão III



	L m	S mm	€	U	IC
1694L10	10	13	14,20	1	016940110
1694L20	20	13	17,60	1	016940120

Beta

1694A/L

fitas métricas com punho, caixa em ABS anti-choque, fita em fibra de vidro revestida a PVC, classe de precisão III



	L m	S mm	€	U	IC
1694A/L30	30	13	35,00	1	016940230
1694A/L50	50	13	46,00	1	016940250

1694B/L

fitas métricas com punho caixa em ABS anti-choque, fita em fibra de vidro revestida a PVC, classe de precisão II



	L m	S mm	€	U	IC
1694B/L50	50	12,5	70,50	1	016940350

1695XS

nível de bolso com base magnética em V em alumínio
2 bolhas inquebráveis
precisão: 1mm/m



	L mm	H mm	S mm	€	U	IC
1695XS	70	48,5	20	14,20	5	016950250

1696

níveis com bolhas inquebráveis e corpo em perfil de alumínio anodizado – precisão: 1 mm/m



	L mm	H mm	S mm	€	U	IC
1696	200	50	19	23,80	2	016960002
	400	50	19	27,50	2	016960004
	500	50	19	30,00	2	016960005
	600	50	19	32,00	2	016960006
	800	50	19	40,00	2	016960008
	1000	50	19	44,50	2	016960010

1696A

nível em alumínio moldado sobre pressão, envernizado, com 1 base rectificada e 2 bolhas invioláveis, precisão de 1 mm/m



	L mm	H mm	S mm	€	U	IC
1696A	300	43	23	34,00	2	016960103
	400	43	23	36,00	2	016960104
	500	43	23	39,50	2	016960105
	600	43	23	43,00	2	016960106
	1000	43	23	86,50	1	016960110

1696B

nível magnético corpo em perfil de alumínio anodizado, 2 bolhas invioláveis, precisão de 1 mm/m



	L mm	H mm	S mm	€	U	IC
1696B	200	49	22	37,00	2	016960202
	300	49	22	38,50	2	016960203
	400	49	22	40,50	2	016960204
	500	49	22	49,00	2	016960205
	600	49	22	52,00	2	016960206

Beta

Beta

1696D

níveis em alumínio anodizado com pegas,
4 bases e 3 bolhas inquebráveis,
precisão: 1 mm/m



L mm	H mm	S mm	€		
300	47	25	32,00	2	016960353
400	47	25	36,00	2	016960354
500	47	25	39,50	2	016960355
600	47	25	44,50	2	016960356

1696S

níveis de pedreiro em alumínio
com 2 bolhas inquebráveis
precisão: 1 mm/m

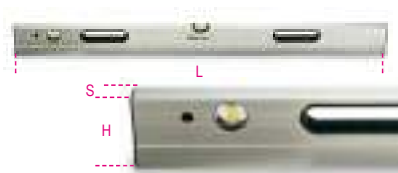

L mm	H mm	S mm	€		
1500	90	25	114,00	1	016960415
2000	90	25	135,00	1	016960420
2500	90	25	169,00	1	016960425
3000	90	25	190,00	1	016960430

1697

laser linhas cruzadas,
30 metros, linhas verdes,
com base magnética e suporte de parede,
em estojo

Características técnicas:

- autonivelamento das linhas cruzadas
- função de autonivelamento pode ser desligada para utilização manual
- laser diodo 515 Nm, classe 2
- alcance: 30 m
- precisão de medição: ± 1 mm a 5 m
- amplitude autonivelamento: $3^\circ \pm 0.5^\circ$

- corpo em borracha ABS antiderrapante
- 1/4" encabadouro fêmea
- pilhas 2xAA
- autonomia: 4 horas

BASE:

- 1 base magnética para utilização individual e combinada, 1/4" encabadouro macho
- 1 suporte de aperto ajustável para vários perfis de madeira e metal (para utilização em combinação com a base magnética)
- alinhamento horizontal e vertical rápido num ângulo de 90°

CE



IP55



H mm	L mm	S mm	€		
82	57	89,5	281,00	1	016970030

320x230x90 mm

1699L

nível linear de precisão em ferro fundido
com base prismática rectificada,
2 bolhas invioláveis
precisão de 0,05 mm/m



DIN 877

	L mm	A mm	€		
1699L	200	49	340,00	1	016990002

1699L/1

nível linear de precisão em ferro fundido
com base prismática rectificada,
2 bolhas invioláveis em caixa de madeira
precisão de 0,02 mm/m



DIN 877

	L mm	A mm	€		
1699L/1	200	49	361,00	1	016990005

1699Q

nível quadrado de precisão
em ferro fundido com 2 bases prismáticas
e 2 bases planas rectificadas
e 2 bolhas invioláveis
precisão de 0,05 mm/m



DIN 877

L mm	A mm	€		
150	40	481,00	1	016990015
200	48	605,00	1	016990020

1700N

ponteiros para pedreiro



L mm	S mm	€		
250	16	18,80	5	017000005
300	16	20,30	5	017000006

1700N/PM

ponteiros para pedreiro
com punho de protecção



L mm	S mm	€		
250	16	25,00	2	017000105
300	16	29,50	2	017000106

1701N

cinzeis para pedreiro



L mm	A mm	S mm	€		
250	23	16	20,20	5	017010001
300	23	16	21,70	5	017010003

1701N/PM

cinzeis para pedreiro
com punho de protecção



L mm	A mm	S mm	€		
250	23	16	26,00	2	017010101
300	23	16	29,50	2	017010103

1701PMR

punhos de protecção para artigos 1700N e 1701N



D	L	€	Icon	Icon	Code
mm	mm				
16	115	12,10			1 017010206

1701NE/...

cinzeis para electricistas



	SxL	€	Icon	Icon	Code
	mm				
1701NE3	10x200	12,50			5 017010406
1701NE4	10x250	13,20			5 017010409

1702N

talhadeiras largas



A	SxH	€	Icon	Icon	Code
mm	mm				
50	13x23	26,50			2 017020005
70	13x23	27,00			2 017020007

1702N/PM

talhadeiras largas com punho de protecção



A	SxH	€	Icon	Icon	Code
mm	mm				
50	13x23	32,00			2 017020105
70	13x23	35,50			2 017020107



Aconselhamos uma refrigeração constante da lâmina durante o re-afiação

1702PMR

punho de protecção para artigo 1702N



L	€	Icon	Icon	Code
mm				
115	9,40			1 017020200

1704

pés-de-cabra

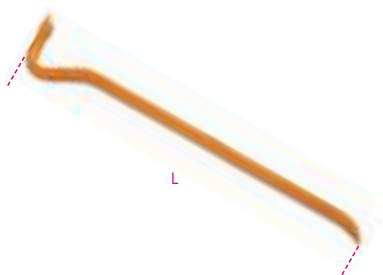

L	Icon	Icon	Icon	€	Icon	Icon	Code
mm	mm	mm	mm				
500	16	35	28	34,00			2 017040050
600	16	34	26	38,00			2 017040060
800	18	38	29	53,50			2 017040080

1704A

pés-de-cabra com extremidades abertas e pontiagudas endurecidas e temperadas

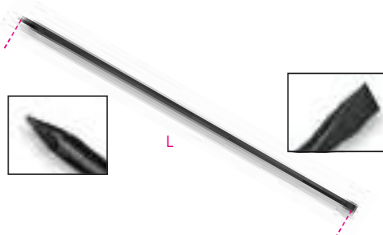

L	Ø	mm	€	Icon	Icon	Code
mm	mm	mm				
1500	25	45	115,00			1 017040110
2000	25	55	135,00			1 017040120

1704C

alavanca com extremidades pontiaguda e chata fechada



L	Icon	Icon	Icon	€	Icon	Icon	Code
mm	mm	mm	mm				
1200	21-31	39		116,00			1 017040210
1400	31-37	42		139,00			1 017040212
1600	25-37	42		172,00			1 017040215

1705

traçador de linhas em alumínio



L	€	Icon	Icon	Code
m				
1705	30	22,70		4 017050001

1705PT

pó para traçagem

- recipiente com dispensador
- azul



g	€	Icon	Icon	Code
250	14,70			5 017050025

1706DGT

Instrumento digital de medição da profundidade das ranhuras dos pneus



1706DGT	€	Icon	Icon	Code
	42,50			1 017060011

1707

conta-fios

roscas métricas ISO a 60° e Whitworth a 55°



P (ISO)	W	€	Icon	Icon	Code
0,25÷6	62÷4x1"	19,10			5 017070001

1707A/1 - 2 - 3

medidor de raios, lâminas côncavas e convexas em aço



	R	L	€	Icon	Icon	Code
	mm	mm				
1707A/1	1,0÷7,0	70 34	29,00			2 017070007
1707A/2	7,5÷15	85 32	31,50			2 017070015
1707A/3	15,5÷25	85 30	31,50			2 017070025

1708/8 - 13 - 20

apalpa-folgas



	€	🔧	📦
1708/8 S = 0,05±0,50 mm	7,30	5	017080008
1708/13 S = 0,05±1,00 mm	8,20	5	017080013
1708/20 S = 0,05±1,00 mm	13,30	5	017080020

1709/10 - 1709/18

quebra porcas



	L mm	A max mm	€	🔧	📦
1709/10	82,5	17 (M10)	62,00	1	017090010
1709/18	107,8	24 (M16)	68,50	1	017090018

1710

quebra porcas hidráulico



	C min mm	C max mm	€	🔧	📦
7(M4)	7(M4)	22(M14)	284,00	1	017100001

1712E/1 - 2 - 3

pesca peças magnético

F = força magnética



	L mm	D mm	F kg	€	🔧	📦
1712E/1	420	7,5	0,5	36,50	2	017120011
1712E/2	530	15	1,8	46,50	2	017120012
1712E/3	532	19	3,0	57,50	2	017120013

1712TF

Iman telescópico com cabeça flexível

• Com anilha de limpeza a jacto



	L mm	D mm	F kg	€	🔧	📦
150+590	150+590	11	1	24,20	1	017120600

1713M

pesca peças magnético

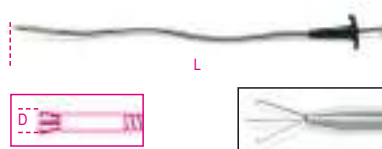

	L mm	D mm	€	🔧	📦
500	500	7	51,00	2	017130011
1000	1000	7	89,50	1	017130015

1713M/K7

kit de 7 ferramentas de inspeção para peças com encabadouro sextavado de 1/4"

- kit inclui:
- 1 punho telescópico, comprimento 185-660 mm
 - 1 espelho de inspeção retangular, 65x43 mm
 - 1 espelho de inspeção redondo, Ø 52 mm
 - 1 íman, Ø 16,3 mm
 - 1 luz LED ultra-brilhante
 - 1 pescapeças flexível (ref. 1713M)
 - 1 bandeja magnética em aço inox
 - 3 baterias LR44



	€	🔧	📦
1713M/K7	180,00	1	017130100

≡ 297x165x52 mm - 0,8 kg

1714

espelho de inspeção plástico



	L mm	D mm	€	🔧	📦
1714	155	25	4,45	5	017140001

1715

espelho telescópico orientável, corpo em metal cromado



	L mm	D mm	€	🔧	📦
1715	180±540	30	38,00	1	017150001

1715FL/A

espelho quadrado



	L mm	A mm	B mm	€	🔧	📦
1715FL/A	600	53	90	46,00	1	017150110

1715R/FL

jogo de 2 espelhos de substituição para artigos 1715FL/A e 1715FL/B

	€	🔧	📦
1715R/FL	9,70	1	017150151

1715FL/B

espelho rectangular com iluminação



	L mm	A mm	B mm	€	🔧	📦
1715FL/B	553	53	90	54,50	1	017150115

1715B/R5L

jogo de 5 lâmpadas de substituição para artigo 1715FL/B

	€	🔧	📦
1715B/R5L	7,90	1	017150152

1715I

espelho telescópico de inspeção com função de ampliação 5x

- Punho em PVC antiderrapante
- Espelho de inspeção e punho em aço inox



	L mm	D mm	€	🔧	📦
1715I	250±720	55	35,50	1	017150020

1715L

espelho telescópico de inspeção com luz LED

- Corpo em aço inoxidável
- Tamanho de bolso, com clip
- Fornecido com 3 baterias L736F



	L mm	D mm	€	🔧	📦
1715L	265±765	50	56,00	1	017150005

1716A

raspador angular para uso genérico



	L mm	L1 mm	€	🔧	📦
1716A	240	125	13,10	3	017160040

1716P

rascador para embalagens



L	L1	Ø	€	Q	Ref
250	125	6	16,10	3	017160020

1716R

furador com ponta redonda

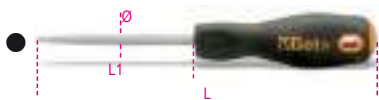

L	L1	Ø	€	Q	Ref
215	100	6	11,30	5	017160001

1716U

rascador em gancho para uso genérico



L	L1	Ø	€	Q	Ref
195	80	6	13,10	3	017160025

1717A

rascador curvo



L	L1	L2	€	Q	Ref
150	70	260	24,70	2	017170015
200	75	310	26,50	2	017170020
250	100	360	29,50	2	017170025

1717B

rascador triangular



L	L1	L2	€	Q	Ref
150	75	260	21,40	2	017170115
200	85	310	24,90	2	017170120
250	100	360	28,00	2	017170125

1717C

rascador direito



L	S	L1	€	Q	Ref
150	18	270	21,20	2	017170215
200	20	320	23,70	2	017170220
250	25	370	26,50	2	017170225

1717D

rascador direito de corte frontal



L	S	L1	€	Q	Ref
150	150	23	29,00	2	017170320

1717T

rascadores triangulares, com 2 lâminas



L	€	Q	Ref
310	13,60	1	017170610

1717T RT

lâminas triangulares sobressalentes



L	€	Q	Ref
65	2,79	1	017170660

1717T RS

lâminas moldáveis sobressalentes



€	Q	Ref
2,79	1	017170661

1717V

rascadores de pintura, lâminas para utilização em tamanhos diversos



L	A	€	Q	Ref
200	38	9,10	1	017170703
285	65	19,50	1	017170706

1717V R

lâminas para referência 1717V



L	€	Q	Ref
38	2,79	1	017170753
65	3,95	1	017170756

CORTES DE LIMAS DE ENGENHEIRO

Grossoiro

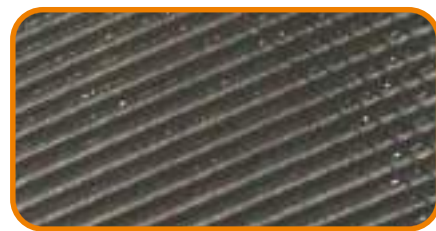

Segundo corte



Suave



1718D...Q

limas quadradas bastardas, sem punho

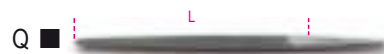

	L	L	€	Q	Ref
1718D6/Q	150	6	10,70	5	017180121
1718D8/Q	200	8	12,70	5	017180131
1718D10/Q	250	10	17,30	5	017180141

1718A...Q

limas quadradas meia-murças, sem punho

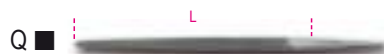

	L	L	€	Q	Ref
1718A6/Q	150	6	10,90	5	017180021
1718A8/Q	200	8	13,10	5	017180031
1718A10/Q	250	10	18,00	5	017180041

1718D...T

limas triangulares bastardas, sem punho

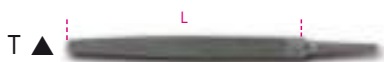

	L mm	L "	€		
1718D6/T	150	6	12,80	5	017180123
1718D8/T	200	8	16,30	5	017180133
1718D10/T	250	10	21,50	5	017180143

1718A...T

limas triangulares meia-murças, sem punho

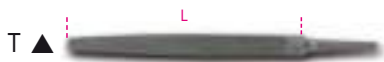

	L mm	L "	€		
1718A6/T	150	6	13,10	5	017180023
1718A8/T	200	8	16,70	5	017180033
1718A10/T	250	10	22,50	5	017180043

1718D...P

limas chatas bastardas, sem punho



	L mm	L "	€		
1718D6/P	150	6	10,10	5	017180125
1718D8/P	200	8	11,80	5	017180135
1718D10/P	250	10	15,90	5	017180145

1718A...P

limas chatas meia-murças, sem punho



	L mm	L "	€		
1718A6/P	150	6	10,70	5	017180025
1718A8/P	200	8	12,30	5	017180035
1718A10/P	250	10	17,30	5	017180045

1718D...M

limas meia-cana bastardas, sem punho



	L mm	L "	€		
1718D6/M	150	6	14,10	5	017180127
1718D8/M	200	8	17,40	5	017180137
1718D10/M	250	10	22,50	5	017180147

1718A...M

limas meia-cana bastardas, sem punho

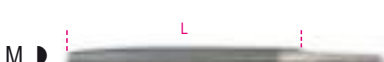

	L mm	L "	€		
1718A6/M	150	6	14,30	5	017180027
1718A8/M	200	8	17,80	5	017180037
1718A10/M	250	10	23,70	5	017180047

1718D...R

limas redondas bastardas, sem punho



	L mm	L "	€		
1718D6/R	150	6	10,10	5	017180129
1718D8/R	200	8	11,80	5	017180139
1718D10/R	250	10	15,50	5	017180149

1718A...R

limas redondas meia-murças, sem punho



	L mm	L "	€		
1718A6/R	150	6	10,70	5	017180029
1718A8/R	200	8	12,30	5	017180039
1718A10/R	250	10	16,40	5	017180049

1718D...S5

jogo de 5 limas bastardas, sem punhos



	L mm	L "	€		
1718D6/S5	150	6	57,50	1	017180130
1718D8/S5	200	8	70,00	1	017180140
1718D10/S5	250	10	93,00	1	017180150

1718A...S5

jogo de 5 limas meia-murças, sem punhos



	L mm	L "	€		
1718A6/S5	150	6	59,50	1	017190030
1718A8/S5	200	8	72,00	1	017180040
1718A10/S5	250	10	98,00	1	017180050

1719BMD...Q

limas quadradas bastardas, com punho



	L mm	L "	€		
1719BMD6/Q	150	6	14,50	5	017190191
1719BMD8/Q	200	8	16,10	5	017190221
1719BMD10/Q	250	10	22,10	5	017190241
1719BMD12/Q	300	12	29,00	3	017190325

1719BMA...Q

limas quadradas meia-murças, com punho



	L mm	L "	€		
1719BMA6/Q	150	6	14,70	5	017190021
1719BMA8/Q	200	8	17,60	5	017190052
1719BMA10/Q	250	10	22,90	5	017190071
1719BMA12/Q	300	12	34,00	3	017190311

1719BMX...Q

limas quadradas murças, com punho



	L mm	L "	€		
1719BMX6/Q	150	6	15,60	5	017190022
1719BMX8/Q	200	8	20,20	5	017190053
1719BMX10/Q	250	10	27,50	5	017190072

1719BMD...T

limas triangulares bastardas, com punho



	L mm	L "	€		
1719BMD6/T	150	6	17,40	5	017190193
1719BMD8/T	200	8	19,90	5	017190223
1719BMD10/T	250	10	27,00	5	017190243
1719BMD12/T	300	12	38,00	3	017190326

1719BMA...T

limas triangulares meia-murças, com punho



	L mm	L "	€		
1719BMA6/T	150	6	17,40	5	017190023
1719BMA8/T	200	8	21,50	5	017190054
1719BMA10/T	250	10	28,00	5	017190073
1719BMA12/T	300	12	40,00	3	017190313

1719BMX...T

limas triangulares murças, com punho



	L mm	L "	€		
1719BMX6/T	150	6	20,50	5	017190024
1719BMX8/T	200	8	27,00	5	017190055
1719BMX10/T	250	10	34,50	5	017190074

1719BMD...P

limas chatas bastardas, com punho



	L mm	L "	€		
1719BMD6/P	150	6	14,50	5	017190195
1719BMD8/P	200	8	15,30	5	017190225
1719BMD10/P	250	10	21,60	5	017190245
1719BMD12/P	300	12	28,50	3	017190327

1719BMA...P

limas chatas meia-murças, com punho



	L mm	L "	€		
1719BMA6/P	150	6	15,30	5	017190025
1719BMA8/P	200	8	17,40	5	017190056
1719BMA10/P	250	10	22,40	5	017190075
1719BMA12/P	300	12	32,00	3	017190315

1719BMX...P

limas chatas murças, com punho



	L mm	L "	€		
1719BMX6/P	150	6	15,60	5	017190026
1719BMX8/P	200	8	20,50	5	017190057
1719BMX10/P	250	10	27,00	5	017190076

1719BMD...M

limas meia-cana bastardas, com punho



	L mm	L "	€		
1719BMD6/M	150	6	19,10	5	017190197
1719BMD8/M	200	8	20,50	5	017190227
1719BMD10/M	250	10	28,00	5	017190247
1719BMD12/M	300	12	38,50	3	017190328

1719BMA...M

limas meia-cana meia-murças, com punho



	L mm	L "	€		
1719BMA6/M	150	6	19,90	5	017190027
1719BMA8/M	200	8	23,30	5	017190058
1719BMA10/M	250	10	30,00	5	017190077
1719BMA12/M	300	12	42,50	3	017190317

1719BMX...M

limas meia-cana murças, com punho



	L mm	L "	€		
1719BMX6/M	150	6	21,20	5	017190028
1719BMX8/M	200	8	26,00	5	017190059
1719BMX10/M	250	10	36,50	5	017190078

1719BMD...R

limas redondas bastardas, com punho



	L mm	L "	€		
1719BMD6/R	150	6	14,50	5	017190199
1719BMD8/R	200	8	15,10	5	017190229
1719BMD10/R	250	10	21,10	5	017190249
1719BMD12/R	300	12	28,00	3	017190329

1719BMA...R

limas redondas meia-murças, com punho



	L mm	L "	€		
1719BMA6/R	150	6	15,40	5	017190029
1719BMA8/R	200	8	17,20	5	017190060
1719BMA10/R	250	10	21,80	5	017190079
1719BMA12/R	300	12	29,50	3	017190319

1719BMX...R

limas redondas murças, com punho



	L mm	L "	€		
1719BMX6/R	150	6	17,80	5	017190031
1719BMX8/R	200	8	19,90	5	017190061
1719BMX10/R	250	10	27,00	5	017190081

1719BMA...B5

conjunto de 5 limas meia-murça, com punho, em bolsa



	L mm	L "	€		
1719BMA8/B5	200	8	96,50	1	017190297
1719BMA10/B5	250	10	125,00	1	017190298

1719BMD...B5

conjunto de 5 limas bastardas, com punho, em bolsa



	L mm	L "	€		
1719BMD8/B5	200	8	87,00	1	017190303
1719BMD10/B5	250	10	120,00	1	017190305

1719BMD...S5

jogo de 5 limas bastardas, com punhos



	L mm	L "	€		
1719BMD6/S5	150	6	80,50	1	017190200
1719BMD8/S5	200	8	87,00	1	017190230
1719BMD10/S5	250	10	120,00	1	017190250
1719BMD12/S5	300	12	162,00	1	017190363

1719BMA...S5

jogo de 5 limas meia-murça, com punhos



	L mm	L "	€		
1719BMA6/S5	150	6	82,50	1	017190030
1719BMA8/S5	200	8	96,50	1	017190070
1719BMA10/S5	250	10	125,00	1	017190080
1719BMA12/S5	300	12	178,00	1	017190361

1719BMX...S5

jogo de 5 limas murças, com punhos



	L mm	L "	€		
1719BMX6/S5	150	6	90,50	1	017190032
1719BMX8/S5	200	8	114,00	1	017190069
1719BMX10/S5	250	10	152,00	1	017190082

1719BMB/P

limas chatas universais,
punhos em material plástico

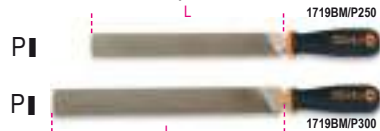

L mm	L" mm	€	U	U
250	10	34,50	5	017190152
300	12	40,50	5	017190153

1719BMC

limas meia-cana e chatas,
punhos em material plástico



UNI 5569 - UNI 5568

	L mm	L" mm	€	U	U
1719BMC/M 250	250	10	22,90	6	017190252
1719BMC/M 300	300	12	29,00	4	017190253
1719BMC/P 250	250	10	18,10	6	017190262
1719BMC/P 300	300	12	22,40	4	017190263

1719BM/RL

lima chata paralela
1 lado áspero segundo corte,
1 lado lima grão grosso
punho em plástico



	L mm	L" mm	€	U	U
1719BM/RL	200	8	18,10	5	017190360

1719BM/RR

lima redonda,
punho em plástico



	L mm	L" mm	€	U	U
1719BM/RR	200	8	19,00	5	017190351

1719BM/RG

lima meia-cana,
punho em plástico



	L mm	L" mm	€	U	U
1719BM/RG	200	8	18,80	5	017190353

1719BM/RP

lima chata,
punho em plástico



	L mm	L" mm	€	U	U
1719BM/RP	200	8	19,30	5	017190352

1719BMR/B3

jogo de 3 limas meia-murça,
com punhos,
em estojo para pendurar



L mm	L" mm	€	U	U
200	8	57,50	1	017190358

1719BMR

punho para limas



	L mm	A mm	€	U	U
1719BMR/0	95	25	4,15	10	017190950
1719BMR/0B	110	29	4,15	10	017190955
1719BMR/1	110	29	4,15	10	017190951
1719BMR/1B	110	29	4,15	10	017190953
1719BMR/2	123	31	4,15	10	017190952
1719BMR/2B	123	31	4,15	10	017190954

	mm	"		
1719BMR/0	100/150	4/6	▲▲	●●
1719BMR/0B	100/150	6/8	■●	●●
1719BMR/1	150/200	6/8	▲▲	●●
1719BMR/1B	150/200	6/8	■●	●●
1719BMR/2	250/300	10/12	▲▲	●●
1719BMR/2B	250/300	10/12	■●	●●

1720/...

limas de calado

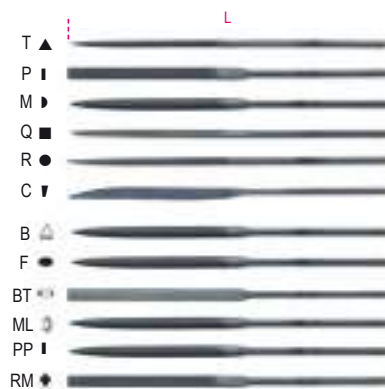

UNI 5569 UNI 5670

	L mm	€	U	U
1720T	160	8,40	5	017200004
1720P	160	8,40	5	017200006
1720M	160	8,40	5	017200008
1720Q	160	8,40	5	017200009
1720R	160	8,40	5	017200010
1720C	160	8,40	5	017200012
1720B	160	8,40	5	017200005
1720ML	160	8,40	5	017200007
1720BT	160	8,40	5	017200011
1720F	160	8,40	5	017200013
1720PP	160	8,40	5	017200014
1720RM	160	8,40	5	017200015



	€	U	U
1720/S3	25,00	1	017200000

1720/B



	€	U	U
1720/B6	52,50	1	017200002
1720/B12	101,00	1	017200003

1720D/...

limas de calado diamantadas



	L mm	€	U	U
1720D/T	160	54,00	2	017200104
1720D/P	160	54,00	2	017200106
1720D/M	160	54,00	2	017200108
1720D/Q	160	54,00	2	017200109
1720D/R	160	54,00	2	017200110
1720D/C	160	54,00	2	017200112





1720D/B6 € 326,00 1 017200120

1721/B6

jogo de 6 limas para contactos em bolsa de plástico



1721/B6 € 28,00 1 017210010

1723

saca-molas



1723 L mm 210 € 18,10 5 017230001

1725

serrote



1725 L mm 420 L1 mm 300 € 23,70 4 017250001

1725CR

mini serrote



1725CR L mm 250 L1 mm 150 € 13,00 5 017250010

1726

serrote, sistema tensor da folha incorporado no punho



1726 L mm 440 L1 mm 300 € 31,50 4 017260001

1726BM

Serrote com sistema de substituição rápida da lâmina

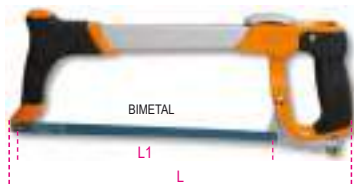

1726BM L mm 400 L1 mm 300 € 51,00 1 017260050

1727

serrote, série pesada



1727 L mm 515 L1 mm 300 € 21,80 4 017270001

1727BM

serrote, trabalho com uma mão



1727BM L mm 315 L1 mm 300 € 26,50 5 017270020

1728...

folhas de serra

1728LA



150 mm

1728BM

(HSS-BIMETAL)



24x1"

1728CO

(HSS-BIMETAL COBALT)



300 mm

1728LA € 1,54 100 017280001

1725CR

1725MQ € 3,85 100 017280010

1728BM 1725-1726 1727-1727M

1728CO 1725-1726 1727-1727M € 5,40 50 017280030

1729CG

serra para gesso cartonado



1729CG L mm 310 L1 mm 160 € 26,00 2 017290200

1729DM 450

serra para madeira

dentado médio, 12 dentes/polegadas



1729DM 450 L mm 450 L1 mm 400 € 29,50 4 017290450

1730

espátulas universais, com punho e lâminas em aço inox



S mm	L mm	L1 mm	€		
38	210	85	7,00	2	017300038
63	220	95	8,30	2	017300063
75	220	95	9,00	2	017300075
100	220	95	10,40	2	017300100

1730M

espátulas misturadoras, com punho e lâminas em aço inox



L1 mm	L mm	S mm	€		
150	245	27	9,70	2	017300215
200	330	28	18,00	2	017300220
250	365	36	22,30	2	017300225

1730V 38

espátula de vidroceiro, em aço inox



1730V 38 S mm 38 L mm 225 L1 mm 100 € 7,00 2 017300338

1736A

escova de aço para limas



1736A L mm 240 € 12,60 10 017360010

1737

escovas em latão



1737	L mm 145	€ 6,20	10	017370001
------	----------------	-----------	----	-----------

1737NX

escova curva em aço



1737NX	L mm 270	€ 7,40	5	017370010
--------	----------------	-----------	---	-----------

1737AC

escova em aço



1737AC	L mm 275	€ 7,00	5	017370020
--------	----------------	-----------	---	-----------

1737B

pares de escovas de limpeza de terminais e bornes de baterias



1737B		€ 17,20	1	017370050
-------	--	------------	---	-----------

1738

pincel



1738	L mm 210	H mm 30	€ 10,00	10	017380001
------	----------------	---------------	------------	----	-----------

1739C

rebitadora extensível, fornecida com 5 bicos intercambiáveis



Ø mm	3,2	4	4,8	5	6	6,4
Alluminio	•	•	•	•	•	•
Inox	•	•	•	•	•	•

1739C	L max mm 810	€ 139,00	1	017390152
-------	--------------------	-------------	---	-----------

1740AN

rebitadora para trabalhos pesados, fornecida com 5 bicos intercambiáveis • com reservatório de rebites



Ø mm	3,2	4	4,8	5	6	6,4
Alumínio	•	•	•	•	•	•
Aço inox	•	•	•	•	•	•

1740AN	L mm 530	€ 126,00	1	017400103
--------	----------------	-------------	---	-----------

1740B

alicate de cravagem para trabalhos pesados, fornecido com 5 pontas intercambiáveis



Ø mm	2,4	3	3,2	3,2	4,8
alumínio	•	•	•	•	•
aço inox	•	•	•	•	•
Inox	•	•	•	•	•

1740B 280	L mm 280	€ 81,50	1	017400280
-----------	----------------	------------	---	-----------

Ø mm	2,4	3,2	4,0	4,8	6,4
alumínio	•	•	•	•	•
aço inox	•	•	•	•	•
Inox	•	•	•	•	•

1740B 330	L mm 330	€ 94,50	1	017400330
-----------	----------------	------------	---	-----------

1741B

alicate de rebitar fornecido com 4 bicos intermutáveis



Ø mm	2,4	3,2	4	4,8	5
Alluminio	•	•	•	•	•
Aço	•	•	•	•	•
Aço inoxidável	•	•	•	•	•

1741B		€ 43,00	1	017410000
-------	--	------------	---	-----------

1741B/C5

alicate de rebitar 1741B com jogo de 700 rebites em alumínio



1741B/C5		€ 133,00	1	017410025
----------	--	-------------	---	-----------

	Ø mm	L mm	n.
1741RV2,9K	3,0	6	200
1741RV3,2K	3,2	8	200
1741RV3,8K	4,0	10	100
1741RV4K	4,0	12	100
1741RV4,8K	4,8	12	100

415x155x60 mm - 3,1 Kg



1741BP

alicate de rebitar fornecido com 4 bicos intermutáveis



Ø mm	2,4	3,2	4	4,8	5
Alumínio	•	•	•	•	•
Aço	•	•	•	•	•
Aço inoxidável	•	•	•	•	•

1741BP € 66,00 1 017410350

1741U

alicate de rebitar compacto com força ajustável com 4 bicos intercambiáveis
3 pernas: melhor fixação do rebite



Ø mm	2,4	3	3,2	4	4,8
Alumínio	•	•	•	•	•
Aço	•	•	•	•	•
Aço inoxidável	•	•	•	•	•

1741U € 51,00 1 017410450

1741RV...K

rebites em alumínio



1741RV 2,9K	21,60	1 017410191
ØxL = 3x6 mm		
1741RV 3,2K	22,30	1 017410192
ØxL = 3,2x8 mm		
1741RV 3,8K	28,00	1 017410193
ØxL = 4x10 mm		
1741RV 4K	30,50	1 017410194
ØxL = 4x12 mm		
1741RV 4,8K	38,00	1 017410195
ØxL = 4,8x12 mm		

Os preços indicados são para 500 unidades

1742N

alicate de cravar porcas, fornecido com 4 bicos intercambiáveis e 4 pinos (1x M3;M4;M5;M6)



1742N € 143,00 1 017420002

	Ø mm	L mm
3	5	11
4	6	11
5	7	13
6	9	17

1742N/KR

kit de 4 pinos de substituição para artigo 1742N



M3	61,50	1 017420063
M4	61,50	1 017420064
M5	61,50	1 017420065
M6	61,50	1 017420066

1742R-AL/M...

rebites roscados em alumínio para itens 1742-1742A-1946KF



1742R-AL M3	5,40	1 017420023
ØxL = 5x10 mm		
M = 3		
1742R-AL M4	5,50	1 017420024
ØxL = 6x12 mm		
M = 4		
1742R-AL M5	5,90	1 017420025
ØxL = 7x13 mm		
M = 5		
1742R-AL M6	7,10	1 017420026
ØxL = 9x15 mm		
M = 6		

Os preços indicados são para 20 unidades

1742R-A/M...

rebites roscados em aço para itens 1742-1742A-1946KF



1742R-A M3	5,70	1 017420013
ØxL = 5x11 mm		
M = 3		
1742R-A M4	5,80	1 017420014
ØxL = 6x11 mm		
M = 4		
1742R-A M5	6,10	1 017420015
ØxL = 7x13 mm		
M = 5		
1742R-A M6	7,30	1 017420016
ØxL = 9x17 mm		
M = 6		
1742R-A M8	6,90	1 017420018
ØxL = 11x17 mm		
M = 8		
1742R-A M10	8,30	1 017420020
ØxL = 13x24 mm		
M = 10		
1742R-A M12	9,30	1 017420022
ØxL = 12x24 mm		
M = 12		

Os preços indicados são para 20 unidades
• Os preços indicados são para 10 unidades

1742N/C4

alicate de cravar porcas 1742N com jogo de 400 porcas em aço



1742N/C4 € 319,00 1 017420006

	M	Ø mm	n.
1742R-A/M3	3	5	100
1742R-A/M4	4	6	100
1742R-A/M5	5	7	100
1742R-A/M6	6	9	100

415x155x60 mm - 2,9 kg

1742AN

alicate de cravar porcas para trabalhos pesados, fornecido com 7 bicos intercambiáveis



1742AN € 450,00 1 017420101

	Ø mm	L mm
M 5	7	13
6	9	17
8	11	17
10	13	24

1742AN/KR

kit de 4 pinos de substituição para artigo 1742AN



	€		
1742AN/KR M3 M3	41,50	1	017420153
1742AN/KR M4 M4	41,50	1	017420154
1742AN/KR M5 M5	41,50	1	017420155
1742AN/KR M6 M6	41,50	1	017420156
1742AN/KR M8 M8	41,50	1	017420158
1742AN/KR M10 M10	41,50	1	017420160
1742AN/KR M12 M12	41,50	1	017420162

1742AN/C

alicate de cravar porcas para trabalhos pesados 1742AN com jogo de 80 porcas em aço



	€		
1742AN/C	525,00	1	017420106

	M	Ø mm	n.
1742R-A/M5	5	7	20
1742R-A/M6	6	9	20
1742R-A/M8	8	11	10
1742R-A/M10	10	13	10

420x240x80 mm - 2,5 kg

1749

pistola para isolantes envernizada



	L min mm	€		
1749	340	16,10	2	017490001

1749A

pistola para isolantes modelo profissional, corpo em alumínio



	L min mm	€		
1749A	360	50,50	1	017490010

1749A/RB

câmara de substituição para artigo 1749A

	€		
1749A/RB	1,15	1	017490051

1749A/RT

placa de pressão para artigo 1749A

	€		
1749A/RT	2,53	1	017490052

1749AC

pistola injectora para produtos químicos



	L min mm	€		
1749AC	360	44,50	1	017490005

1750

pistola de massa

Pode ser utilizada com cartucho 1750CG ou massa a vulso



1 g, 550 bar Max

1750CG cc	L mm	€		
400	380	49,50	1	017500500
600	450	58,50	1	017500750

1750R/1 - 1750R/2

tubos flexíveis de substituição Nylon



	L mm	€		
1750R/1	310	7,90	2	017500030
1750R/2	410	8,80	2	017500040

1750RC

ponteira rígida curva



	L mm	M mm	€		
1750RC	150	10x1	6,50	2	017500050

1750RT

ponteira de lubrificação com 4 garras modelo hidráulico



	M mm	€		
1750RT	10x1	5,80	5	017500110

1750RP/1 - 1750RP/2

acoplamentos para ligações planas

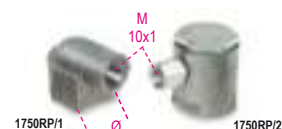

	Ø mm	M mm	€		
1750RP/1	16	10x1	14,30	2	017500115
1750RP/2	22	10x1	32,00	2	017500120

1750CG

cartuchos de massa para refª. 1750



cc	€		
400	17,50	18	017500140
600	21,80	18	017500160

1750KG10

Bomba de massa com balde de 10 kg com mangueira de alta pressão, 2 m

- Fornecido com união giratória, para evitar o estrangulamento da mangueira
- Bomba em alumínio fundido com válvula de retenção

3 níveis de pressão disponíveis:

- 4 g - 275 bar
- 7 g - 206 bar
- 9 g - 137 bar



312,5 mm

1750KG10 € 223,00 1 017500100

1750TA

Bico de alta pressão com bloqueio através de 6 pinos

Uma vez posicionado, permanece no eixo e conectado ao copo; não precisa de ser mantido como um bico comum
Fácil de desconectar mesmo sob pressão
Rosca intermédia universal M10x1: adequada para todos os tipos de pistolas de massa: elétrica, pneumática, manual etc.
Sem deformação até 550 bar



17 mm
30 mm

1750TA € 52,50 1 017500111

1750TLA

Bico de alta pressão com bloqueio através de 6 pinos, versão longa

- Uma vez posicionado, permanece no eixo e conectado ao copo
- Fácil de desconectar mesmo sob pressão
- Rosca intermédia universal M10x1: adequada para todos os tipos de pistolas de massa: elétrica, pneumática, manual etc.
- Sem deformação até 550 bar



17 mm
80 mm

1750TLA € 70,50 1 017500112

1750M

mini pistola de massa

- Com micro bocal
- Particularmente adequada para ferramentas pneumáticas



Ø 0,5 mm

Ø

1750M	cc	D mm	L mm	€	U	1	017500025
	100	43	145	26,00			

1750M3

mini pistola de massa, com 3 bicos

- equipada com três bicos intercambiáveis: 0,7 - 1,0 - 1,4 mm
- particularmente indicada para lubrificação de ferramentas pneumáticas
- pode ser utilizada com massa avulso
- adequada para utilização de massa até grau NLGI 2



Ø 0,7 mm

Ø 1,0 mm
Ø 1,4 mm

Ø

1750M3	cc	Ø mm	L mm	€	U	1	017500003
	85	42	160	34,50			

1751CR

almotolia em metal, bico rígido



L

D

cc	D mm	L mm	€	U	1
200	62	140	17,70	4	017510202
300	75	140	19,10	4	017510203
500	85	140	20,30	4	017510205
700	100	140	22,20	2	017510207
1000	100	140	24,10	2	017510210

1751N

almotolias metálicas, bico flexível



L

D

cc	D mm	L mm	€	U	1
200	62	140	18,70	4	017510020
300	75	140	20,30	4	017510030
500	85	140	21,30	4	017510050
700	100	140	23,20	2	017510075
1000	100	140	25,00	2	017510100

1752

almotolias plásticas bico rígido



L

D

cc	D mm	L mm	€	U	1
200	67	140	12,10	4	017520002
300	77	140	13,10	4	017520003
500	95	140	13,80	4	017520005

1754

almotolias plásticas bico flexível



130 mm

D

cc	D mm	L mm	€	U	1
150	60	130	11,10	5	017540015
250	65	130	12,50	5	017540025

1755C

almotolia em plástico,
bico curvado



cc	L mm	A mm	€	🔧	📄
125	110	46	5,10	5	017550112
250	110	60	6,90	5	017550125
500	110	74	7,80	4	017550150

1756

oleador tipo caneta

adequado para utilização com óleos minerais



cc	L mm	€	🔧	📄
5	140	26,50	2	017560001

1756B

oleador tipo caneta

- com serrilhado antiderrapante
- temperatura de funcionamento: -10 °C - +60 °C
- densidade mínima de óleo SAE 10



cc	L mm	€	🔧	📄
500	280	25,50	2	017560220

1756C

oleador tipo caneta, 200 ml, em polipropileno

- adequado para fluido dos travões
- junta dupla EPDM
- temperatura de funcionamento: +0 - +50 °C
- densidade de óleo mínima utilizável: ISO 150, SAE 90 (óleo da caixa de velocidades), SAE 40 (óleo do motor)



1756C	€	🔧	📄
	40,00	1	017560502

1756D

oleador tipo caneta, 1500 ml, em polipropileno

- Junta dupla NBR
- Temperatura de funcionamento: +0 - +50 °C
- NÃO adequado para combustível



1756D	€	🔧	📄
	91,50	1	017560515

1756E

oleador tipo caneta, compatível com gasolina



1756E	€	🔧	📄
	47,00	1	017560610

1756G

oleador tipo caneta
capacidade: 1.5 l

- Adequado para:
- filtros de óleo diesel
 - depósitos Cerina



- Contém:
- 2 tubos com encaixe rápido fêmea para ligação de tubos de óleo diesel
 - 2 encaixes rápidos machos, em metal
 - 1 adaptador cônico para tubos de borracha

1756G	€	🔧	📄
	140,00	1	017560615

1756C-20R

O-rings (par) para oleadores 1756C

1756C-20R	€	🔧	📄
	5,20	1	017560503

1756D-20R

O-rings (par) para oleadores 1756D

1756D-20R	€	🔧	📄
	8,70	1	017560516

1757

reservatório para líquido de baterias



cc	D mm	€	🔧	📄
250	60	4,10	4	017570002
500	75	4,95	4	017570004
1000	90	6,90	2	017570006

1757A

reservatório para líquido de baterias



cc	€	🔧	📄
2000	50,50	1	017570020

1758

funil adaptável

Particularmente útil para veículos sem profundidade nos bujões



1758	€	🔧	📄
	63,00	1	017580020

1758ADB-D

funil de não-retorno para AdBlue®,
com encaixe reto



1758 ADB-D	€	🔧	📄
	40,50	1	017580050

1758ADB-45°

funil de não-retorno para AdBlue®,
com encaixe 45°



1758 ADB-45
I
Max 1
€ 43,00 1 017580060

1758A

funil de não-retorno
com encaixe rápido, Ø 38 mm
Para veículos do grupo Volkswagen



1758A
€ 96,50 1 017580010

1758B

funil de não-retorno
com encaixe rápido
Particularmente adequado para
veículos VAG



1758B
€ 42,00 1 017580030

1758B-1,6

funil de não-retorno, 1600 ml,
com encaixe rápido
uniões rápidas
para veículos do grupo VAG



H1 H2 Ø
mm mm mm
1758B-1,6 125 100 155
€ 47,00 1 017580033

1758B-RNT

Encaixe de não retorno para funil de
combustível item 1758B - 1758B-1,6

para motor Renault 1.5 dCi



1758B-RNT
€ 30,00 1 017580035

1758B/K5

kit de encaixes rápidos de não-retorno,
para funil de combustível 1758B - 1758B-1,6

Kit inclui:

- 1 adaptador para motores 1.5 dCi Renault, Dacia, Nissan
- 1 adaptador para motores 1.5/1.6 dCi Renault, Dacia, Nissan
- 1 adaptador para motores diesel 3.0 BMW
- 1 adaptador para motores gasolina 1.5/2.0, grupo VAG
- 1 adaptador de ligação para funil, com torneira



1758B/K5
€ 120,00 1 017580040

1758RD

funil de refrigerante com encaixe rápido



H Ø
mm mm
1758RD 248 172
€ 130,00 1 017580070

1758S

suporte de parede para funis 1758 e encaixes
rápidos



1758S
€ 97,50 1 017580080

1758LG

folha de alumínio moldável, com revestimento
em borracha,
para canalização de líquidos



L H
mm mm
1758LG 365 168
€ 53,50 1 017580006

1758M

Funil



L
mm
1758M 350
€ 15,90 1 017580000

1758R

reservatório para líquidos

Bico flexível, amovível e prático



	lt	€		
1758R 1	1	10,00	1	017580201
1758R 2	2	11,90	1	017580202
1758R 3	3	21,20	1	017580203
1758R 5	5	26,00	1	017580205

1758VT

kit de teste para cabeça do cilindro

Indica num curto espaço de tempo se o tanque de expansão contém dióxido de carbono.



1758VT	€	204,00	1	017580100
--------	---	--------	---	-----------

600x190x50 mm - 1 kg

1758VT/L

líquido de teste para cabeça do cilindro



1758VT/L	€	58,50	1	017580101
----------	---	-------	---	-----------

1759

dispositivo óptico para análise de refrigerantes, baterias, limpa-vidros e fluidos AdBlue®

Fornecido em estojo rígido

Compensação automática de temperatura

Acido de bateria: intervalo de medição: 1.1÷1.3 kg/l

Refrigerante propileno: -25 °C ÷ -50 °C

Refrigerante etileno: -25 °C ÷ -50 °C

Limpa-vidros: -25 °C ÷ -40 °C

AdBlue: medição percentagem de ureia: 30% ÷ 45%



1759	€	189,00	1	017590251
------	---	--------	---	-----------

1759A

densímetro para líquido anti-congelante



1759A	L mm	€	79,50	1	017590001
-------	---------	---	-------	---	-----------

1759B

densímetro para líquido de baterias



1759B	L mm	€	52,00	1	017590005
-------	---------	---	-------	---	-----------

1759HD/3

Kit ferramentas para detecção de fugas e enchimento rápido de sistemas de refrigeração

• Para detecção de fugas do circuito de refrigeração (tubos, juntas, bombas, radiadores) e enchimento rápido, prevenindo a formação de bolhas de ar



1759HD/3	€	665,00	1	017590063
----------	---	--------	---	-----------

600x500x140 mm - 6,5 kg

1759HD/RR

aparelho de teste de fugas de sistemas de arrefecimento



1759HD/RR	€	204,00	1	017590064
-----------	---	--------	---	-----------

450x310x110 mm - 2,2 kg



1759LR

ferramenta de lavagem com sistema de arrefecimento utilizando ar comprimido, a alta pressão da água proporciona um sistema de lavagem eficiente

- fornecido com 6 adaptadores de ligação ao sistema
- alavanca com bloqueio de posição para utilização contínua
- fornecida com adaptador rápido para água



1759LR 402 mm € 510,00 1 017590070
390X330X100

1759HD/TRUCK

ferramenta de teste e vedante para sistema de refrigeração em veículos pesados



1759HD/TRUCK € 462,00 1 017590065
440x330x100 mm - 3 kg

1759TT

Kit de 4 pares de tampões para detecção de fugas no turbo para utilização com punho de encher pneus



1759TT € 245,00 1 017590300
400x160x100 mm - 1,8 kg

SERVIÇO DE CERTIFICAÇÃO PARA INSTRUMENTOS ELETRÔNICOS

A certificação de instrumentos de medição como Multímetros, Grampos Amperímetros, **Tacómetros e Termómetros** é essencial nos setores ou campos de aplicação em que são essenciais medições precisas, inequívocas e perceptíveis.

Para termómetros de infravermelhos é emitido um relatório de calibragem de 4 pontos (mínimo, máximo e dois pontos intermédios) com rastreamento ENAC.

A Beta Utensili S.p.A. fornece o serviço de certificação a pedido. Para requerer este serviço, contacte o seu revendedor.



1760DGT

multímetro digital auto



CARACTERÍSTICAS TÉCNICAS

RPM (tacómetro):
Para motores de 2 e 4 cilindros
RPM4 600 - 4000 RPM
RPM4 600 - 12000 RPM (x10 RPM)
RPM2/DIS 300 - 4000 RPM
RPM2/DIS 300 - 6000 RPM (x10 RPM)
Ângulo excêntrico: 4-8 CYL
Tensão DC: 400mV-4/40/400/1000V
Tensão AC: 4/40/400/700V
Corrente DC: 40/400mA-4/20A
Corrente AC: 40/400mA-4/20A
Resistência: 400Ω-4/40/400kΩ-4/40MΩ
Capacidade: 40/400nF-4/40/100μF
Frequência: 5/50/500Hz-50/500-10MHz
Ciclo de trabalho: 0.1% - 99.9%
Amplitude de impactos: 1 - 10ms
Teste diodo: Corrente de teste 0.3mA
Continuidade: <150Ω - Corrente de teste <0.3mA
Visor: Alto-contraste, backlight 4-digit LCD
Sobrevoltagem: Categoria II 1000V
Encerramento automático: 30 minutos
Alimentação: 1 bateria 9V (incluída)
Pinça de indução (incluída)
2 ponteiros (incluídas)
Estojo em tecido macio (incluído)
Manual de instruções

1760DGT € 311,00 1 017600005



1760DGT/2

Multímetro digital automático, portátil, com função de osciloscópio de 2 canais e gerador de forma de onda



Inclui:
- pontas de prova para multímetro
- 2 pinças crocodilo BNC para osciloscópio
- pontas de prova para osciloscópio (1X e 10X)
- carregador de bateria
- bolsa de nylon

DADOS TÉCNICOS:
Ecrã: 2.8" cor TFT
Resolução: 320 x 240 pixels
Corrente: 100V-240V AC, 50Hz-60Hz; DC INPUT 5V DC-2A
Bateria: 2 x 2600 mAh

ESPECIFICAÇÕES DO MULTÍMETRO
Teste: Voltagem, Corrente, Resistência, Capacidade, Diodos e On-Off
Voltagem Máxima: 600V AC-DC
Corrente Máxima: 10A AC-DC
Resistência Máxima: 40MOHM
Capacidade Máxima: 100µF

ESPECIFICAÇÕES DO OSCILOSCÓPIO
Horizontal
Largura de banda: 40MHz
Amplitude da amostragem de sinal: 250MSa/s (canal único) - 125MSa/s (canal duplo)
Amplitude SEC/DIV : 5ns/div ÷ 500s/div 1,2,5 seqüência vertical
Vertical
Amplitude VOLTS/DIV: 10mV/div÷10V/divat BNC input
Seleção analógica, limite de largura de banda, típico: 20MHz
Resposta baixa frequência (-3db): ≤10Hz a BNC
Precisão de ganho DC: ± 3% para modo de aquisição Normal ou Médio, 10V/div ÷ 10 mV/div
Disparo
Tipo de disparo: Borda
Modo: Auto, Normal, Individual
Inclinação: Subida, Descida, Subida & Descida
Entrada de sinal: CH1, CH2
Entrada
Acoplamento: DC, AC ou GND
Fator de atenuação da ponta de prova: 1X, 10X, 100X, 1000X
Gerador arbitrário de formato de onda
Frequência de formato de onda: Senoidal (1Hz÷25MHz),
Quadrada (1Hz÷10MHz), Rampa (1Hz÷MHz), EXP (1Hz÷5MHz)
Largura: 2.5Vpp (50Ω) - 5Vpp (alta impedância)
Impedância de saída: 50Ω

Dimensões: 199 x 98 x 40 mm
Peso: 624g

1760DGT/2 € 870,00 1 017600008

1760B

multímetro digital



ESPECIFICAÇÕES
Voltagem DC: 200 mV-2/20/200/1000V
Voltagem AC: 2-20/200/700V
Corrente DC: 2/20/200 mA-20 A
Corrente AC: 2/200 mA- 20 A
Resistência: 200Ω - 2/20/200 kΩ - 2/20 MΩ
Capacidade: 2/20/200 nF - 2/200 µF
Temperatura: -20° + 1000°C/-4 °F ~ +2000°F
Frequência: 20kHz
Potência de alimentação: Pilha 1 9V (incluída)

1760B € 201,00 1 017600012

1760/OHM

Multímetro/megômetro para teste de isolamento de alta tensão.
Indicador TRUE RMS



Amplitude de medição
Precisão
Voltagem AC/DC: 50mV - 1000V ±0.06% - ±0.1% rdg
Corrente AC/DC: 0.01µA - 10A ±0.5% - ±1% rdg
Resistência: 0.01Ω - 50MΩ ±0.2% - ±2% rdg
Meg OHM: 0.01 - 5000MΩ ±4% rdg. corrente máx. 1mA
Capacitância: 5nF - 10mF ±1.5% - ±3% rdg
Frequência: 50Hz - 100 MHz ±0.02% - ±0.1% rdg
Temperatura: -50 °C - +1350 °C ±0.5% rdg
Teste de diodo: 3V dc
Teste de continuidade: <30 Ω

1760/OHM € 955,00 1 017600025

1760/RMS

multímetro digital industrial

EN61010-1
EN61326-1



Tipo de leitura Precisão
Voltagem AC/DC 110mV - 600V ±0.8% - ±2% rdg
Corrente AC/DC 110µA - 10A ±1.5% - ±2% rdg
Resistência 110Ω - 40MΩ ±1.2% - ±2.5% rdg
Capacitância 11nF - 40mF ±5% - ±10% rdg (até 11mF)
Frequência 1100Hz - 110 MHz ±1.2% - ±1.5% rdg
Temperatura -32°C - +1000°C ±3% - ±5% rdg
Teste de diodo, 3V DC ±10% rdg
Teste de continuidade <30 Ω -

1760/RMS € 345,00 1 017600020

1760S

multímetro digital compacto

Leitura TRUE RMS (valor efetivo)



Parâmetros mensuráveis:
Voltagem DC: 200 mV-2/20/200/600V
Voltagem AC: 100/600V
Corrente DC: 200 mA-10 A
Corrente AC: 0,01-10 A
Resistência: 200Ω - 2/20/200 kΩ - 2 MΩ
Teste diodo: 0.4 ÷ 0.7
Fonte alimentação: 2 pilhas 1.5V, tipo AAA

1760S € 99,50 1 017600022

153x75x42 mm

1760PA/80

pinça amperimétrica AC/DC, 80A

Para medir fugas de baixa corrente ou valores de absorção em veículos

CE



- Alcance: 1mA-80A AC/DC
- Função lanterna com LED branco
- Visor LCD com retro-iluminação
- Função de reposição a zero
- Função de memorização
- Desliga-se automaticamente
- Alimentação: 2 pilhas 1.5V AAA

1760PA/80 € 259,00 1 017600002

1760PA/AC

pinça amperimétrica e multímetro digital

A: AC
V: AC/DC

CE



ESPECIFICAÇÕES

Voltagem DC: 400 mV - 4/40/400/600 V
Voltagem CA: 400 mV - 4/40/400/600 V
Corrente CA: 40/400/1000 A
Resistência: 400Ω - 4/40/400 kΩ - 4/40 MΩ
Frequência: 5/50/500 Hz - 5/50/500 kHz - 5/10 MHz
Capacidade: 40/400 nF - 4/40/100 μF
Temperatura: -20 °C + 1000 °C / -4 °F + 1832 °F
Alimentação: 1 bateria de 9V (incluída)

1760PA/AC L mm 190 € 212,00 1 017600050

1760PA/AC-DC

pinça amperimétrica e multímetro

A: AC/DC
V: AC/DC

CE



A: AC/DC
V: AC/DC

ESPECIFICAÇÕES

Voltagem DC: 0.1mV ± 600V
Voltagem AC: 0.1mV ± 600V
Corrente AC: 0.01A ± 1000A
Corrente DC: 0.01A ± 1000A
Resistência: 0.1Ω ± 40MΩ
Capacidade: 0.001nF ± 40 μF
Frequência: 0.001kHz ± 4kHz
Temperatura: -40°C ± 1000 °C
-40°F ± 1832°F

1760PA/AC-DC € 384,00 1 017600000

1760PA/AC-DC2000

grampo amperómetro com multímetro digital e ligação Bluetooth

Função TRUE RMS na gama AC

A: AC/DC
V: AC/DC

CE



Parâmetros mensuráveis:

- Voltagem DC: 0.1mV ± 1000V
- Voltagem AC: 0.1mV ± 1000V
- Corrente AC: 0.01A ± 2000A
- Corrente DC: 0.01A ± 2000A
- Resistência: 0.1Ω ± 60MΩ
- Capacidade: 1nF ± 6000 μF
- Frequência: 10kHz ± 20kHz
- Temperatura: -20 °C ± 1000 °C -4 °F ± 1832 °F
- Potência de alimentação: 3 pilhas 1.5V, tipo AA (incluídas)
- Ligação Bluetooth (versão 4.0)

H mm 300 L mm 110 P mm 43 € 760,00 1 017600003

380x280x100 mm - 1,78 kg

1760DGT-R3

Cabos de substituição para multímetros digitais e braçadeiras amperométricas



1760DGT-R3 € 27,00 1 017600603

1760/RSE

Detetor de sinal

Permite testar a alimentação de componentes como: electro-injetores common rail, eletro-injetores gasolina/ GPL, injetores piezoelétricos, válvulas solenoides de regulação de fluxo / válvulas egr, bobinas, etc...

CE



Permite fazer o diagnóstico de componentes elétricos através de uma sonda.

Em sistemas com componentes eletromecânicos / eletrônicos com uma unidade de controlo esta ferramenta permite verificar se:

- A unidade de controlo está a ser alimentada e se está a funcionar corretamente
- Os cabos de ligação estão íntatos
- O componente não foi desligado
- O componente não entrou em curto circuito
- O componente está a funcionar eletronicamente

1760/RSE € 540,00 1 017600170



1760/TC2

tacómetro digital combinado



DADOS TÉCNICOS

- Para medições de:
 - rotações (rpm) à distância
 - rotações (rpm) por contacto
 - velocidade linear (m/min ou ft/min)
- Visor LCD de 5-dígitos
- Escala:
 - rotação à distância 2.5+99,999 rpm
 - rotação por contacto 0.5+19,999 rpm
 - velocidade linear 0.05+1,999.9 m/min
- Frequência: 0.8 seg
- Alimentação: 4 pilhas 1.5V, tamanho AA, ou unidade de alimentação de 6V (não incluída)
- Fornecido com:
 - adaptador para medir por contacto;
 - ponteira macho (contacto) em borracha (2 peças);
 - ponteira fêmea (contacto) em borracha (1 peça);
 - fita medição linear (1 peça);
 - etiquetas reflectoras;
 - manual de instruções;
 - caixa plástica

	L	H	€		
1760/TC2	230 mm	74 mm	269,00	1	017600161

1760R/TC2

jogo de etiquetas reflectoras para artigo 1760/TC2



1760R/TC2	€		
	23,80	1	017600561

1760K

detector de voltagem AC sem contacto, com mini-tocha LED

Intervalo de teste: 200-1000Vac 50/60Hz
 CAT III-1000V
 Utiliza 2 pilhas AAA (incluídas)



1760K	€		
	43,00	1	017600140

1760PT

ferramenta de teste de tensão e continuidade, 12-690V AC/DC

Funcões:

- continuidade
- rotação de fases
- corrente
- tocha LED

CE



IP64
 CATIV
 - 600V ;
 CATIII
 - 1000V

1760PT	€		
	173,00	1	017600150

1760/IR500

termómetro digital de infravermelhos com sistema de direcionamento laser duplo

não é adequado para medir a temperatura corporal



CE

Caraterísticas Técnicas

Temperatura: -50 + 500 °C (-22 + +932 °F)
 Resolução: 0,1 °C (0,1 °F)
 Emissividade: 0.1 + 1 ajustável
 Precisão: -50 °C + +20 °C (+/- 3 °C); 20 + 500 °C (+/-2% or 2 °C)
 Resolução: (D:S): 12:1
 Desliga automaticamente: a cada 10 segundos
 Temperatura de funcionamento: 0 °C + 50 °C
 Temperatura de armazenamento: -20 °C + 60 °C
 Alimentação: 1 9V bateria

1760/IR500	€		
	185,00	1	017600350

1760/IR1000

termómetro digital de infravermelhos com sistema de direcionamento laser duplo

não é adequado para medir a temperatura corporal



CE

Caraterísticas Técnicas

Temperatura: -50 °C + +1000 °C (-58 °F + +1832 °F)
 Resolução do visor: 0.1 °C (0.1 °F)
 Emissividade: 0.1 + 1 ajustável
 Precisão: -50 °C + 20 °C (+/- 3.5 °C); 20 °C + 300 °C (+/-1% or 1 °C); 300 °C + 1000 °C (+/-1.5%)
 Resolução: (D:S): 20:1
 Temperatura de funcionamento: 0 °C + 50 °C
 Temperatura de armazenamento: -10 °C + 60 °C
 Alimentação: 2 1.5V (baterias tipo AAA)

1760/IR1000	€		
	306,00	1	017600400

1760/IR1600

termómetro digital de infravermelhos com sistema de apontamento laser

não é adequado para medir a temperatura corporal



CE

Dados técnicos

Capacidade de medição:
 -50 °C a +1600 °C / -58 °F to +2912 °F
Seleção escala: °C/°F
Precisão: ±1.5% or ±2 °C a 20 °C
Potência do laser: <1mW
Tempo de resposta: 1sec
Emissividade: 0.10-1.0 ajustável
Relação distância: (D:S) 50:1
Temperatura de operação: 0 °C + 50 °C / 32 °F + 122 °F
Humidade de operação: 10% a 90% RH
Visor LCD em Backlit
Função de armazenamento
Auto-desligar
Alimentação: 1,9V pilha (incluída)
Estojo em alumínio
Manual de instruções

1760/IR1600	mm	mm	€		
	200	115	855,00	1	017600461



1760LX

luxímetro digital portátil

EN61010-1
EN61326-1

CE



Característica técnicas:
Intervalo de medição Precisão básica
medição Lux: 0-200000 ±3%
medição FC: 0-20000 ±3%
Fonte alimentação: 1 x 9V

	L	€		
1760LX	165 mm	117,00	1	017600820

1760TMC

Câmara termográfica de infravermelhos

Câmara termográfica compacta para medição da temperatura sem contacto, adequada para aplicações nas indústrias de construção, mecânica, instalação eléctrica e aquecimento.

ecrã LCD TFT, 2", 240x320
detetor, 32x32 pixels
velocidade sequencial 7Hz
sensibilidade térmica <347mK
deteção automática de pontos quentes e pontos frios
registo de imagens em formato BMP (max. 100 imagens)
emissividade ajustável
alimentação: 3 pilhas AAA alcalinas
interface USB
IP54
amplitude de medição: -20 °C ÷ +60 °C
banda espectral de infravermelhos: 6.5÷14µm
fusão de imagem visível/infravermelhos: 0.5; 1; 2m
opção de alarme, em função das temperaturas máxima e mínima definidas

CE



	€		
1760TMC 600	980,00	1	017600710

1760WM

anemómetro digital com sensor de ventoinha

EN61010-1
EN61326-1

CE



Característica técnicas:
Intervalo de medição Precisão básica
velocidade do ar m/s: 0.4-30 ±2%
velocidade do ar k/n: 1.4-108 ±2%
velocidade do ar ft/m: 80-5900 ±2%
velocidade do ar mil/h: 0.8-58 ±2%
fluxo de ar CFM: 0-99990 ±0-9.999 ft2
fluxo de ar CMM: 0-99990 ±0-9.999 m2
fluxo de ar CMS: 0-99990 ±0-9.999 m2

	L	€		
1760WM	170 mm	94,50	1	017600800

1761

alicate torce-aramo com retorno automático



	L	€		
1761	255 mm	76,00	1	017610101

1761RS/1

alicate torce-aramo reversível com retorno automático



	L	€		
1761RS/1	220 mm	136,00	1	017610130

1762

alicate vazador



	€		
1762	35,50	2	017620001

1763

Alicate para agrafos de estofos auto

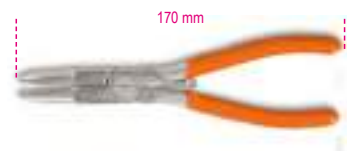

	€		
1763	41,50	1	017630001

1763G/S500

500 agrafos para estofos auto



	€		
1763G/S500	78,00	1	017630105

1764/K5

rebitadora manual para rebites em plástico

fornecida com rebites de 4 tamanhos

kit contém:

- 10 rebites Ø 5x17.2 mm
- 10 rebites Ø 5x15.8 mm
- 10 rebites Ø 6.3x25.2 mm
- 10 rebites Ø 6.6x17.2 mm



	€		
1764/K5	60,50	1	017640001

1764/K5-R

pack de 20 rebites em plástico para artigo 1764/K5



	€		
1764/K5-R1	16,60	1	017640003
1764/K5-R2	16,60	1	017640004
1764/K5-R3	16,60	1	017640005
1764/K5-R4	16,60	1	017640006

1765/C24

caixa com 24 ferramentas para extracção de auto-rádios



1765/C24 € 226,00 1 017650001

1766

ventosa dupla



max kg 50 € 141,00 2 017660001

1766A

ventosa simples



max kg 30 € 36,00 2 017660005

1766/8

jogo de 8 ferramentas para vidros de viaturas



1766/8 € 525,00 1 017660100

1766ER

ferramenta remoção de frisos das portas, com pega

Fácil remoção de frisos, sem risco de quebras



1766ER € 25,50 1 017660501

1766ER/VW

ferramenta remoção de frisos de janelas de baixo perfil

particularmente adequada para frisos de janelas do grupo VAG com reduzido espaço de aderência



L mm 215 H mm 4 € 18,10 1 017660510

1766L

alavanca para vidros



1766L € 59,00 1 017660015

1766LI

alavanca para inserção de cabo para corte de vidros em automóveis
arestas de corte afiadas



1766LI € 21,00 1 017660016

1766I

pinhos para cabo de aço para vidros refª. 1766G

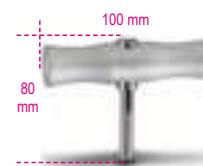

1766I € 57,50 2 017660020

1766G

cabo de aço para vidros

Secção quadrada



50 m € 51,00 1 017660025

1766T

cabo de aço para janelas de vidro

secção triangular



50 m € 59,00 1 017660026



1767A

Apoio telescópico

- Projetado para suportar o capô e tampas de mala com pistons descompactados.

- Pode ser utilizada para impedir que os pedais se movimentem.



L mm
640 ÷ 1090 € 80,00 1 017670000

1767B

kit bloqueio de pedal e volante de direção

o mecanismo de ajuste do gatilho garante regulações precisas com o veículo em aceleração



1767B € 171,00 1 017670100

490x285x95 mm - 2,4 kg

1767PMC

suporte de ferramentas magnético, redondo



1767PMC € 25,00 1 017670020

1767PMR

suporte de ferramentas magnético, rectangular



1767PMR € 51,00 1 017670010

1768

plataforma em alumínio

superfície revestida com material antiderrapante
capacidade máxima de carga: 200 kg



L mm L1 mm H mm € 220,00 1 017680010

1770

x-acto plano fornecido com 2 lâminas de substituição



1770 L mm A mm € 18,10 10 017700001

1770A

x-acto 9 mm com bloqueio automático lâmina 3 lâminas de substituição



1770A L mm A mm € 6,80 10 017700025

1770RL

10 lâminas divisível de 9 mm para ref.^a 1770, 1770BM e 1770F



1770RL € 6,00 5 017700010

1770BM

X-acto, 9 mm, com bloqueio automático da lâmina, 6 lâminas de substituição



1770BM L mm A mm € 13,90 10 017700050

1771

x-acto, 18 mm, fornecido com 3 lâminas



1771 € 10,30 10 017710000

1771BM

x-acto com 6 lâminas de substituição bi-material



1771BM L mm A mm € 22,50 10 017710050

1771HD

x-acto, 18 mm, fornecido com 6 lâminas

- substituição automática da lâmina
- sistema de bloqueio da lâmina



1771HD L mm A mm € 25,50 5 017710100

1771RL

10 lâminas divisível de 18 mm para x-acto ref.^a 1771, 1771BM, 1771HD



1771RL € 8,70 5 017710010

1772M

x-acto de segurança com lâmina retrátil, fornecido com 4 lâminas

- Lâmina retrátil através de mecanismo de mola automático
- Corpo em liga de alumínio fundido
- Removedor de agramas integrado no punho



1772M L mm A mm € 20,50 5 017720040

1772R

x-acto com lâmina trapezoidal retráctil, fornecido com 5 lâminas



	L mm	A mm	€	🔧	📦
1772R	125	18	19,00	5	017720006

1772H

x-acto de lâmina retráctil, de segurança, lâmina de substituição



	L mm	A mm	€	🔧	📦
1772H	170	18	20,00	5	017720029

1772RL/2

10 lâminas trapezoidais de substituição longas, em caixa, para x-actos, 1772H, 1772M, 1772R, 1774, 1777BMT, 1777T



	€	🔧	📦
1772RL/2	4,80	5	017720017

1773A

x-acto



	L mm	A mm	€	🔧	📦
1773A	180	25	20,00	10	017730000

1773RL

10 lâminas divisível de 25 mm para x-acto refª. 1773



	€	🔧	📦
1773RL	19,60	5	017730015

1773S

x-acto com lâmina redonda

- lâmina principal Ø 28 mm
- lâmina secundária para cortar filme
- gancho para pendurar



	L mm	A mm	€	🔧	📦
1773S	190	28	9,40	1	017730100

1773S/RL

3 lâminas redondas, Ø 28 mm para x-acto 1773S



	€	🔧	📦
1773S/RL	4,15	5	017730110

1774

raspador com resguardo de protecção



	L mm	L1 mm	€	🔧	📦
1774	155	60	4,90	5	017740001

1774A

raspador multifuncional, com punho bi-material



	L mm	A mm	€	🔧	📦
1774A	300	40	15,30	1	017740011

1774A/RL

10 lâminas para raspador multi-funções 1774A

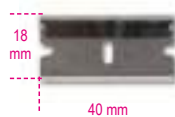

	€	🔧	📦
1774A/RL	7,30	1	017740511

1774S

raspador para remoção de autocolantes



	A mm	L mm	€	🔧	📦
1774S	40	100	8,30	2	017740021

1777BM

navalha com lâmina em aço inoxidável e entalhe para descarnar



	L mm	L1 mm	A mm	€	🔧	📦
1777BM	190	80	16	13,10	5	017770100

1777T

navalha com lâmina trapezoidal em aço, com 5 lâminas de substituição



	L mm	A mm	L1 mm	€	🔧	📦
1777T	160	19	65	28,50	5	017770030

1777BMT

canivete com lâmina trapezoidal rebatível 4 posições ajustáveis da lâmina 4; 9.5; 15.5; 21.5 mm fornecido com 3 lâminas



	L mm	L1 mm	A mm	€	🔧	📦
1777BMT	170	80	19	30,50	5	017770050

1778AN

canivete, lâmina em aço inox, punho leve em alumínio anodizado • em estojo



	L mm	A mm	L1 mm	€	🔧	📦
1778AN	204	26	84	35,00	5	017780065

1778AX

canivete, lâmina em aço de inox serrilhada, pega em alumínio, serration pattern for easier opening

- em estojo



1778AX	L mm	A mm	L1 mm	€		
	189	26	80	38,50	5	017780026

1778BS

canivete com duplo bloqueio de segurança, lâmina serrilhada em aço inox, acabamento em carbono

- em bolsa



1778BS	L mm	A mm	L1 mm	€		
	200	29	85	38,50	10	017780035

1778CM

canivete camuflado, lâmina em aço reforçado, fornecido em estojo



1778CM	L mm	A mm	L1 mm	€		
	195	24	80	36,00	5	017780099

1778M7

canivete, mini lâmina em aço inox, punho com inserts em fibra de vidro

- em estojo



1778M7	L mm	A mm	L1 mm	€		
	163	24	68	31,00	5	017780015

1778P

canivete, lâmina e punho em aço inox e alumínio, mecanismo de bloqueio de abertura

- em estojo



1778P	L mm	A mm	L1 mm	€		
	193	29	72	41,50	5	017780088

1778SCL

canivete acabamento macio, lâmina em aço reforçado, fornecido em estojo



1778SCL	L mm	A mm	L1 mm	€		
	180	22	78	34,00	5	017780089

1778SOS

navalha manutenção automóvel com quebra-janelas e cortante para cintos de segurança fornecida em bolsa



1778SOS	L mm	A mm	L1 mm	€		
	205	25	85	36,00	5	017780080

1778V18

canivete, punho em alumínio

- fornecido em bolsa



1778V18	L mm	A mm	L1 mm	€		
	195	25	85	34,00	5	017780018

1778X

navalhas para manutenção náutica, lâminas em aço inoxidável, punhos em alumínio



1778X	L mm	L1 mm	A mm	€		
	185	85	25	33,00	2	017780050



Beta

1778MT - MULTITOOL

A ferramenta multiusos da BETA destaca-se de ferramentas semelhantes disponíveis no mercado, com características típicas BETA: alicate sinónimo de qualidade inigualável, materiais sofisticados e tecnologia de ponta. Os 11 bits para parafusos, nas geometrias mais populares do mercado, tornam este artigo ideal para qualquer ambiente e condições de trabalho, por exemplo, no campismo, na indústria náutica, na caça ou bricolage.



22 FUNÇÕES

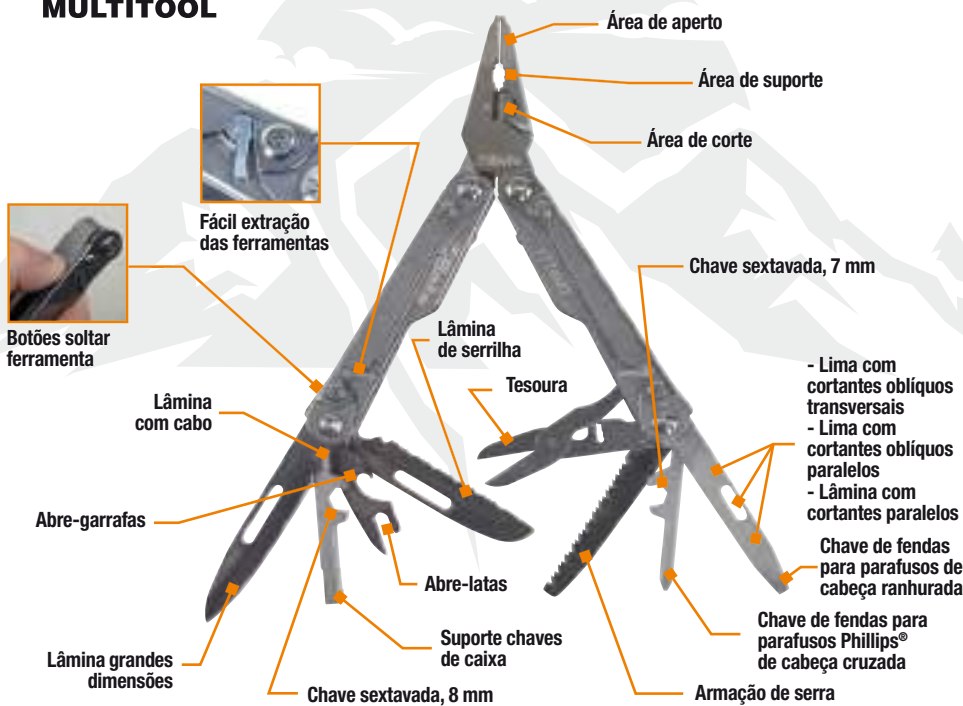

11 bits + chave de caixa



Régua 100 mm / 4"

1778MT

multi-tools
com bits e bolsa
9 ferramentas
22 funções



L mm	L1 mm	€	🔧	📦	📄
180	115	109,00	1	1	017780055

1781

tesoura com lâminas longas e finas



1781	L mm	€	🔧	📦	📄
	132	20,10	2	2	017810001

1783

tesoura de serviços ligeiros



L mm	€	🔧	📦	📄
215	16,70	5	5	017830021
240	18,70	5	5	017830024

1784

tesouras série pesada



L mm	€	🔧	📦	📄
175	23,90	2	2	017840017
200	32,00	2	2	017840020
250	42,50	2	2	017840025
300	57,50	2	2	017840030

1800/100

almofada insuflável (cap. máx. elevação: 100 kg)

- elevação/nivelção
- abertura de portas em caso de emergência



A mm	B mm	S mm	€	🔧	📦	📄
160	150	2+55	68,50	3	3	018000000



ILUMINAÇÃO

A gama de iluminação inclui uma vasta gama de produtos concebida para satisfazer os requisitos de todos os utilizadores, desde a inspeção de pequenos tubos à iluminação de áreas de trabalhos de grandes dimensões.

LANTERNAS

O novo e atraente design, as melhorias técnicas e a ampla escolha de tamanhos permitem a seleção da lanterna mais adequada, tomando como base critérios como brilho, duração da bateria e desempenho.

LÂMPADAS E FOCOS

Graças à tecnologia LED melhorada, à maior vida útil das baterias, a menor tempo de carga, à atenção meticulosa aos materiais e à pesquisa contínua de soluções inovadoras, as luzes de trabalho Beta são uma combinação notável de design, funcionalidade e performance.

Uma gama abrangente concebida para garantir aos profissionais um trabalho nas melhores condições, em qualquer setor e sob quaisquer condições.



WIRELESS

A nova tecnologia sem fio permite carregar as luzes de trabalho mais recentes através de uma base de carga, artigo 1839BRW.

A nova base de carga, 1839BRW,

permite carregar simultaneamente os mais recentes holofotes e lâmpadas, sem ter que utilizar cabos de alimentação. Além disso, o suporte amovível permite carregar telemóveis.



CRI - Color Rendering Index

CCT - Correlated Color Temperature

HOLOFOTES

ITEM	LUMEN	BATERIA	TEMPO DE CARGA	VIDA ÚTIL	IP/IK	CCT	CRI
1837C/2100	500 - 1000 - 2100	Li-Ion 11.1V; 4400 mAh	4.0h	9 - 2.5h	IP65 - IK07	6500K	80+
1837C/4300	1100 - 2100 - 4300	Li-Ion 11.1V; 5200 mAh	4.0h	6 - 1.5h	IP65 - IK07	6500K	80+
1837M	500 - 1000 - 2000	Li-Ion 11.1 V, 5200 mAh	3.5h	2 - 8h	IP65 - IK07	2700-3500-4500-5500-6500K	96+
1838FLASH	360 - 720	Li-Ion 7.4 V; 4000 mAh	4.0h	4 - 8h	IP65	6300K	-
1838POCKET	160 - 400 - 800	Li-Ion 3.7 V; 2600 mAh	4.0h	3 - 9h	IP65	6500K	80+

LANTERNAS

ITEM	LUMEN	BATERIA	TEMPO DE CARGA	VIDA ÚTIL	IP/IK	CCT	CRI
1838/11LED	320	Li-Ion 3.7V; 4200 mAh	4.0h	4h	IP65	6500K	
1838AM	60 - 700 120 (spot)	Li-Ion 3.7V; 2600 mAh	4.0h - USB-C	2.5 - 16h 10h (spot)	IP54 - IK07	6500K	80+ 70+
1838COB	100 - 200 75 (spot)	Li-Ion 3.7V; 1600 mAh	3.0h	3-6h 4h (spot)	IP65	6000K	80+
1838P	80 - 50	Li-Ion 3.7V; 700 mAh	2.5h	4h	IP20	6000K	80+
1838SLIM	100 - 200 180 (back) 80 (spot)	Li-Ion 3.7 V, 700 mAh	2.5h - USB-C	2 - 4h 2h (back) 3h (spot)	IP54 - IK07	6500K	80
1838UV	75 - 150	Li-Ion 3.7V; 1600 mAh	3.0h	3h	IP20	6000K	80
1838SW	250 - 500 - 1000	Li-Ion 3.6V; 3350 mAh	4.5 - 6.5h	3 - 7h	IP65 - IK07	6500K	80+
1838E	500 - 1000 - 2000	Li-Ion 3.6V; 3350 mAh	4.5 - 6.5h	3 - 9h	IP20 - IK07	5500K	80+

LANTERNAS DE CABEÇA

ITEM	LUMEN	BATERIA	TEMPO DE CARGA	VIDA ÚTIL	IP/IK	CCT	CRI
1836B	125 - 250	Li-Ion 3.8V; 1600 mAh	3.0h	5h	IP65 - IK07	6000K	80+
1836AW	30 - 200 - 400	Li-Ion 3.7V; 1500 mAh	2.5h	4-18h	IP65 - IK07	6500K	80+

LUZES DE TRABALHO

ITEM	LUMEN	BATERIA	TEMPO DE CARGA	VIDA ÚTIL	IP/IK	ALCANCE
1833XS/1	100	1 x AAA	-	5h	IP66	85m
1833XS/2	200	2 x AAA	-	10h	IP66	112m
1833S	500	2 x AA	-	10h	IP66	140m
1833M	700	3 x AAA	-	7.5h	IP66	170m
1833L	1100	3 x AA	-	8.5h	IP66	330m
1833L/USB	1200	Li-Ion 3.7 V, 2600 mAh	3.0h - USB-C	3.0h	IP66	230m
1833XSW	80 - 250	Li-Ion 3.7V 2600 mAh	2.0 h	2.0-8.0h	IP54 - IK07	
1833MW	5 - 30 - 400 - 1000	Li-Ion 3.7V; 2600 mAh	4.0 - 6.0 h	2.0-200.0h	IP68 - IK07	
1833XL	1500	3xD	-	22h	IP66	290m
1837F	500	3 x AA	-	14.5h	IP66	125m
1837F/USB	600	Li-Ion 3.7 V, 2900 mAh	4.0h - USB-C	10h	IP66	280m

1833L/USB

lanterna LED de elevada luminosidade recarregável, em alumínio anodizado robusto, até 1,200 lumens

- foco ajustável
- 3 níveis de luminosidade reguláveis
- autonomia: 3.0h
- IP66
- alcance: 230 m
- indicador bateria fraca (<15%)
- carregamento por USB-C
- carregador não incluído



L mm 240 € 133,00 1 018330054

1833RB-L/USB

bateria extra para referência 1833L/USB

1833RB-L/USB € 61,50 1 018330975

1833XS/1

lanterna de inspeção LED, em alumínio anodizado robusto

- 100 lumens
- foco ajustável
- pilhas: 1xAAA (não incluídas)
- IP66
- autonomia: 5.0h
- alcance: 85 m



L mm 92 € 23,00 3 018330000

1833XS/2

lanterna de inspeção LED, em alumínio anodizado robusto

- 200 lumens
- foco ajustável
- pilhas: 2xAAA (não incluídas)
- IP66
- autonomia: 10.0h
- alcance: 112 m



L mm 133 € 25,00 3 018330001

1833XSW

lanterna de inspeção LED,
recarregável sem fio

- 2 níveis de luminosidade: LED SMD, 250 - 80 Lúmen
- Bateria recarregável: 3.7V 700 mAh., 2.59 Wh Li-ion
- 2 modos de carga:
base wireless 1839BRW
fonte de alimentação com entrada USB-C
- Tempo de carga:
2h com base wireless
2h com fonte de alimentação
- Autonomia: 2-8h
- Indicador de nível da bateria LED
- Ímanes na base e atrás
- clipe para cinto
- IP54
- IK07
- Cabo USB-C incluído



L mm 145 € 54,00 1 018330011

1833S

lanterna LED de elevada luminosidade,
em alumínio anodizado robusto,
até 500 lumens

- foco ajustável
- 2 níveis de luminosidade reguláveis
- pilhas: 2xAA (não incluídas)
- autonomia: 10.0h
- IP66
- alcance: 140 m



L mm 150 € 43,00 1 018330002

1833M

lanterna LED de elevada luminosidade,
em alumínio anodizado robusto,
até 700 lumens

- foco ajustável
- 2 níveis de luminosidade reguláveis
- pilhas: 3xAAA (não incluídas)
- indicador bateria fraca (<15%)
- autonomia: 7.5h
- IP66
- alcance: 170 m



L mm 162 € 54,00 1 018330003

1833MW

lanterna LED de elevada luminosidade,
recarregável sem fio

- 4 níveis de luminosidade: LED SMD, 1000 - 400 - 30 - 5 Lúmen
- Bateria recarregável: 3.7V 2600 mAh, 9.62 Wh Li-ion
- 2 modos de carga:
base wireless 1839BRE
fonte de alimentação com entrada USB-C
- Tempo de carga:
6h com base wireless
4h com fonte de alimentação
- Autonomia: 2-200h
- Indicador de nível da bateria com 3 LEDs
- Íman atrás
- IP68
- IK07
- Cabo USB-C incluído



L mm 160 € 99,00 1 018330013

1833L

lanterna LED de elevada luminosidade,
em alumínio anodizado robusto,
até 1,100 lumens

- foco ajustável
- 2 níveis de luminosidade reguláveis
- pilhas: 3xAA (não incluídas)
- indicador bateria fraca (<15%)
- autonomia: 8.5h
- IP66
- alcance: 330m



L mm 196 € 90,00 1 018330004

1833XL

lanterna LED de elevada luminosidade,
em alumínio anodizado robusto,
até 1,500 lumens

- foco ajustável
- 2 níveis de luminosidade reguláveis
- pilhas: 3xD (não incluídas)
- indicador bateria fraca (<15%)
- autonomia: 22.0h
- IP66
- alcance: 290 m



L mm 300 € 113,00 1 018330005

1836AW

lanterna de cabeça LED recarregável, dupla
luminosidade

- emissão de luz dupla:
frente: 3 intensidades de luz, LED COB, 30 - 200 - 400 lumens
cabeça (foco): LED COB, 400 lumens
- bateria recarregável: Li-Ion 3,7 V, 1500 mAh, 5,55 Wh
- porta USB-C
- fornecida com cabo USB-C
- tempo de carga: 2,5 h
- duração da bateria:
frente: 4-18 h
cabeça (foco): 4 h
- IP 65
- IK 07



1836AW € 81,50 1 018360051

1836B

lanterna de cabeça LED recarregável,
dupla luminosidade, com sensor ON/OFF

- Sensor ON/OFF sem contacto
- equipada com cabos USB/minijack + carregador
- 250 lumens
- Duração da bateria: 3-6 h
- IP65



1836B € 148,00 1 018360200

1837F

Lâmpada magnética articulada com LEDs de
alta luminosidade, em alumínio anodizado
robusto,
até 500 lumens

- Foco ajustável
- 2 intensidades
- Pilhas: 3xAA (não incluídas)
- Autonomia: 14.5 h
- Indicador de carga
- IP66



L mm 460 € 98,00 1 018370050

1837F/USB

lâmpada magnética articulada com LEDs de alta luminosidade, em alumínio anodizado robusto, até 600 lúmens

- foco ajustável
- 2 intensidades
- autonomia: 10.0h
- indicador de bateria fraca <15%
- entrada de carga USB-C
- com cabo USB-C
- IP66



L mm 460 € 145,00 1 018370060

1837RB-F/USB

bateria suplementar para referência 1837F/UBS

1837RB-F/USB € 42,50 1 018370960

1838POCKET

luz de bolso articulada LED, com feixe duplo e carregamento sem fio

- emissão dupla:
- luz principal: LED COB, 3 intensidades: 160 - 400 - 800 lúmens
- foco: LED SMD, 250 lúmens
- ângulo de iluminação:
- luz principal: 160°
- foco: 18°
- bateria recarregável 3.7V 2600mAh Li-ion
- 2 modos de carga:
- base sem fio 1839BRW
- fonte alimentação via entrada USB-C
- tempo de carga:
- 4.5 h com base sem fio
- 4 h com fonte de alimentação
- duração da bateria:
- luz principal: 3-9h
- foco: 4.5 h
- indicador nível de bateria de 3 LED
- rotação a 210°
- corpo em borracha antiderrapante
- base magnética
- 1 íman na base
- IP65
- IK07
- com cabo USB-C



L mm 98 I mm 82 S mm 39 € 77,00 1 018380080

1837C

holofote LED recarregável para estaleiros de construção

- 3 níveis de luminosidade
- carregador de bateria: entrada: 100-240V AC - 50/60Hz; saída: 15V 1.5A
- tempo de carga: 4 horas
- indicador de carga com 3 LED
- com rotação 180°
- IP65
- IK07



LxHxI mm	Lm	h	€	1	018370210
220x225x70	2100	2.5	215,00	1	018370210
	1000	5.0			
	500	9.0			
266x236.6x59	4300	1.5	316,00	1	018370430
	2100	3.0			
	1100	6.0			

1837C/RA2100-4300

1837C/RA2100-4300 € 30,50 1 018370970

1837M

lanterna recarregável LED "Color Match" para realce da cor natural dos objetos CRI 96+ até 2000 lumens

- 3 níveis de luminosidade: 500/1,000/2,000 lumens
- CRI (colour rendering index): 96+
- CCT (correlated colour temperature): 2700K/ 3500K/ 4500K/ 5500K/ 6500K
- carregador de bateria: input: 100-240V AC - 50/60Hz; output: 15V 1.5A
- conector de bateria de libertação rápida
- tempo para carregamento total: 3.5 hours
- duração da bateria: 8/4/2 h
- indicador de carga
- seletor com indicador LED da cor da temperatura
- seletor com indicador LED da intensidade de luz
- rotação até 180°
- IP65
- IK07



LxHxI mm	Lm	h	€	1	018370450
220x225x70	500	8.0	336,00	1	018370450
	1000	4.0			
	2000	2.0			

1837M/RA



1837M/RA € 58,00 1 018370975

1837S

tripé telescópico para holofote

- em metal
- altura ajustável: 70÷155 cm
- compatível com os itens 1837C e 1838FLASH



h cm 70÷170 € 70,00 1 018370500

1838FLASH

holofote recarregável ultracompacto, concebido para proporcionar a melhor solução possível para cada aplicação

LUMINOSIDADE ELEVADA: com uma capacidade máxima de iluminação de 720 lumens, com funcionamento a bateria ou cabo, está sempre pronto a utilizar.

UTILIZAÇÃO EM QUALQUER SUPERFÍCIE:

- em superfícies planas: com pés de borracha em 3 posições ou tripé standard 1/4" (similar ao das câmaras fotográficas)
- em estruturas metálicas: com íman ou gancho com rotação a 360 graus.

COMPACTO: com as dimensões 85x100x155 mm, pode ser facilmente transportado no saco de ferramentas e utilizado em espaços reduzidos.

ROBUSTO: concebido para resistir a esforços mecânicos extremos. Durabilidade garantida.



IP65

1838FLASH € 381,00 1 018380300

1838RB/FLASH

bateria para lanterna ref. 1838/FLASH

1838RB/FLASH € 83,00 1 018380930

1838/11LED

lanterna de inspeção recarregável com LEDs de elevada luminosidade, bateria polímero de lítio

- Construção compacta em borracha antiderrapante
- Vidro frontal de fácil substituição
- Gancho para suspensão
- Com carregador, 110-230Vac
- 320 lumens
- Com cabeça LED multi-posições



1838/11LED € 187,00 1 018380111

1838RA/10-11LED

fonte de alimentação para substituição para artigo 1838/10LED e 1838/11LED

CE

1838RA/10-11LED € 39,50 1 018380903

1838RB/10LED

bateria para artigos 1838/10LED e 1838/11LED

1838RB/10LED € 63,00 1 018380902

1838RR/11LED

carregadores para artigo 1838/11LED

1838RR/11LED € 41,50 1 018380914

1838RV/11LED

vidro sobresselente anti-riscos para lanterna 1838/11LED



1838RV/11LED € 5,80 2 018380905



1838AM

lanterna LED de inspeção recarregável, com emissão dupla de luz, articulada, rotação de 180°, com base magnética rotativa e gancho

- emissão dupla de luz:
frente: LED COB, 60-700 lumens, pode ser ajustada com potenciômetro
ponto (cabeça): LED SMD, 120 lumens, interruptor ON-OFF
- bateria recarregável 3.6V 2600mAh Li-ion
- com entrada USB-C
- fornecida com carregador 100-240V / 50-60Hz
- tempo de carga: 4h
- autonomia:
frente: 2.5-16h
ponto (cabeça): 10h
- indicador de nível da bateria 3 LEDs
- articulada, rotação 180° ($\pm 90^\circ$ em relação ao eixo)
- base magnética (com ímã de neodímio), rotação 90°
- gancho rotativo na base

- IP54
- IK07



L I S L1
mm mm mm mm
1838AM 405 40 45 175 € 123,00 1 018380400

1838COB

lanterna LED recarregável compacta

- com gancho para pendurar e corpo em borracha antiderrapante
- bateria de lítio
- 100/200 lumens; foco 75 lumens

CE
IP65



1838COB € 106,00 1 018380010

1838P

lanterna de inspeção recarregável, com dupla emissão: lâmpada e tocha

- Corpo compacto em borracha anti-derrapante
- 50/80 lumens
- Gancho de bolso
- Base magnética com rotação a 180°
- Fornecida com cabo de carregamento USB/jack, 3.5 mm
- Duração: 2.5 horas
- IP20

CE
IP65



1838P € 90,50 1 018380005

1838SLIM

lanterna de inspeção slim, 3-LED, articulada e recarregável

- emissão de luz tripla
- frente: 100/200 lúmens/ atrás: 180 lúmens/ foco (topo): 80 lúmens
- base magnética
- tempo de carga: 2.5h
- autonomia: 2-4h/ foco 3h
- com cabo USB-C

CE
IP54

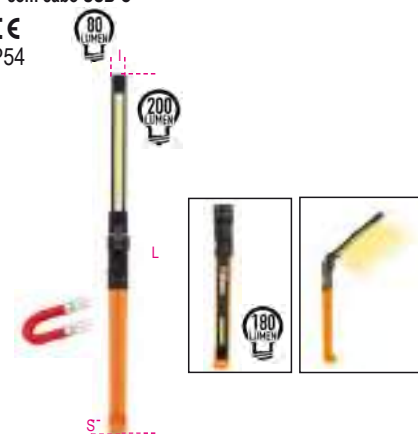

L I S
mm mm mm
1838SLIM 307 17 29 € 82,50 1 018380221



1838SW

lanterna LED de inspeção, recarregável, articulada, com carregador sem fios

- dupla emissão de luz:
- frontal: LED COB, 3 intensidades: 250 - 500 - 1000 lumens
- spot (cabeça): LED SMD, 200 lumens
- bateria 3.6V 3.350mAh Li-ion recarregável
- 2 modos de carga: base 1839BRW sem fios
- fonte alimentação via porta USB-C
- tempo de carga: 6.5h com base sem fios
- 4.5h com fonte de alimentação
- duração da bateria: frontal: 3-5h
- spot (cabeça): 7h
- Indicador nível de bateria de 3 LED
- base rotativa a 180°
- corpo em borracha antiderrapante
- gancho de suspensão duplo
- 3 ímãs na parte posterior
- 1 ímã na base
- IP65
- IK07
- fornecida com cabo USB-C



1838SW	L mm	I mm	S mm	€	1	018380142
	260	53	40	110,00		

1838UV

lanterna de inspeção recarregável UV com elevada luminosidade ideal para detectar fendas

- Corpo compacto em borracha antiderrapante
- Com carregador 100-240Vac / 50-60Hz
- 150 lumens / UV



1838UV	€	1	018380150
	179,00		

1838E

lâmpada de trabalho LED recarregável

- emissão de luminosidade tripla: 500/1000/2000 lumens
- rotativa a 360°
- alcance: 116 ÷ 188 cm
- corpo em alumínio
- ganchos em borracha antiderrapante
- Carregamento USB-C
- 2 modos de carga:
- via porta USB da lâmpada
- via porta da bateria USB interna
- fornecida com carregador de bateria
- entrada: 100-240V ~ 50/60Hz
- saída: DC 5V - 2000 mA
- autonomia: 3-9 h
- IP20
- IK07



IP20
IK07

L min mm	L max mm	I mm	€	1	018380270
1170	1880	150	209,00		

1838E-BT

bateria recarregável com porta USB-C para lâmpada de trabalho 1838E

- Li-Ion 3,6V
- DC 5V - 2000 mA

CE

1838E-BT	€	1	018380271
	59,00		

1839BRW

base de carga sem fios, compatível com as luzes de trabalho 1838POCKET, 1838SW

- duas posições de carga com ligação magnética, para utilização em simultâneo
- com apoio sem fios para carregamento de telemóvel
- indicador LED do nível de carga
- potência entrada máx.: 10W x2
- potência de entrada: AC 100-240V 50/60Hz
- potência de saída: DC 12V 1.5A
- DC 9V 2A
- DC 5V 3A

- porta USB-C
- possibilidade de suspensão através de: 3 potentes ímãs no verso

2 furos para parafusos

- IP20
- IK07



1839BRW	L mm	I mm	S mm	€	1	018390002
	101	190	28	104,00		

1839/R5

cabo USB-C QC 3.0, de substituição para artigos 1838POCKET, 1839BRW

1839/R5	€	1	018390505
	9,50		

1839/R6

transformador de carga rápida USB Q C3.0, de substituição para 1838POCKET, 1839BRW

1839/R6	€	1	018390506
	28,00		

1839/R1

transformador de saída USB, para substituição dos artigos 1833L/USB, 1836B, 1837F/USB, 1838COB, 1838P, 1838S, 1838SLIM, 1838UV, 1838AM, 1838E

CE

1839/R1	€	1	018390501
	27,00		

1839/R2

cabo USB/ 3.5 mm de substituição para artigos 1836B; 1838P; 1838COB; 1838UV

1839/R2	€	1	018390502
	10,50		

1839/R4

cabo USB/USB-C, acessório para as referências 1833L/USB, 1833F/USB, 1838SLIM, 1838S, 1838AM, 1838E

1839/R4	€	1	018390504
	9,30		

Beta

Beta

1842LED/BM

Lanterna com LEDs de elevada luminosidade, 230 Vac

- cabo 10m comp.
- corpo compacto em borracha antiderrapante
- vidro frontal de substituição fácil
- gancho rotativo
- 340 lumens
- com cabeça LED direccionável

CE



IP65

110÷230V

L=10 m

1842LED/BM	L mm	€		
	230	155,00	1	018420301

1842LED/ABM

Lanterna com LEDs de elevada luminosidade, 24 V

- cabo 10m comp.
- corpo compacto em borracha antiderrapante
- vidro frontal de substituição fácil
- gancho rotativo
- 340 lumens
- com cabeça LED direccionável

CE

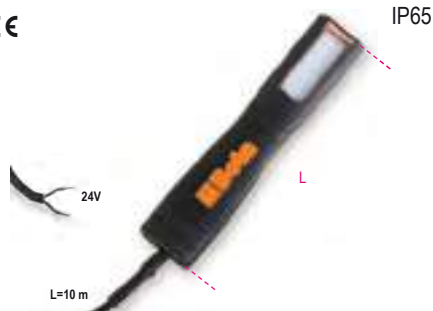

IP65

24V

L=10 m

1842LED/ABM	L mm	€		
	230	147,00	1	018420311

ENROLADORES



A nova e abrangente gama de enroladores da Beta foi desenvolvida com o objetivo de atender às necessidades de todos os profissionais.

- A gama de enroladores é adequada para vários comprimentos e tipos de cabos elétricos, versões com lâmpadas LED e com tomadas e fichas SCHUKO.
- A gama inclui enroladores para tubos de ar comprimido ou água de 8 mm e 10 mm de diâmetro.

Mola de elevada resistência garantindo durabilidade notável e suavidade incomparável.

Tambores em polipropileno espesso, para resistência única ao impacto.

Dispositivo de cremalheira que faz com que o enrolamento automático do cabo pare, fácil de desativar, para permitir o enrolamento contínuo.

Cada enrolador está equipado com um suporte giratório 180° para montagem na parede e um suporte adicional para ligação rápida ao desligar do suporte de parede.

ENROLADORES DE CABO

Uma ampla gama que inclui nada menos que 18 versões, concebidas para satisfazer quaisquer requisitos de trabalho, incluindo dos utilizadores mais exigentes. Comprimentos de 10 m a 30 m, e seções de 2x1,0 mm² a 5Gx1,5 mm², com tipos de cabos H05VV-F e H07RN-F. Todos os enroladores de cabo - até uma seção de cabo de 3Gx2,5mm² - são fornecidos com interruptores de proteção térmica, que são acionados em caso de sobrecarga do circuito elétrico.



ENROLADORES DE TUBO



pag. 347

Uma gama selecionada, com comprimentos de 10 m a 15 m, 8 mm e 10 mm de diâmetro, para utilização com ferramentas pneumáticas.

Como os nossos produtos são à prova de fugas, eles também podem ser utilizados com água.

Item		Condutores	Secção	Tipo de cabo	Comprimento	Caixa	Interruptor proteção térmica	Accessory
1842 15-H05/LED	018420821	2x	1,0 mm ²	H05VV-F	15+1 m	Pequena	SIM	LED lamp
1843 15-H05	018430215	2x	1,5 mm ²	H05VV-F	15+1 m	Pequena	SIM	
1844 10-H05	018440310	3G	1,5 mm ²	H05VV-F	10+1 m	Pequena	SIM	-
1844 15-H05	018440315			H05VV-F	15+1 m	Pequena	SIM	-
1844 15-H07	018440317			H07RN-F	14+1 m	Pequena	SIM	-
1844 30-H05	018440330			H05VV-F	30+2 m	Média	SIM	-
1844 15-H05/SCK	018440316			3G	1,5 mm ²	H05VV-F	15+1 m	Pequena
1844 15-H07/SCK	018440318	H07RN-F	14+1 m			Pequena	SIM	SCHUKO
1845 12-H05	018450365	3G	2,5 mm ²	H05VV-F	12+1 m	Pequena	SIM	
1845 15-H07	018450367			H07RN-F	15+1 m	Média	SIM	
1845 25-H07	018450377			H07RN-F	25+1,5 m	Média	SIM	
1846 10-H05	018460405	4G	1,5 mm ²	H05VV-F	10+1 m	Pequena	NÃO	
1846 10-H07	018460407			H07RN-F	10+1 m	Pequena	NÃO	
1846 15-H05	018460415			H05VV-F	15+1 m	Pequena	NÃO	
1847 10-H05	018470420	4G	2,5 mm ²	H05VV-F	10+1 m	Média	NÃO	
1847 15-H07	018470427			H07RN-F	15+1 m	Média	NÃO	
1848 10-H05	018480510	5G	1,5 mm ²	H05VV-F	10+1 m	Média	NÃO	
1848 15-H07	018480517			H07RN-F	15+1 m	Média	NÃO	

Beta

1842

enrolador de cabo elétrico automático com lanterna LED, 100-240Vac

- com transformador de segurança 230/12V
- cabo H05VV-F 2x1.0 mm²
- comprimento do cabo enrolado: 15 m
- cabo de entrada 1,5 m com tomada tipo SCHUKO
- comprimento do cabo fora do tambor: 1 m
- mecanismo de cremalheira pode ser desativado para manter o cabo puxado
- fornecido com suporte giratório 180° e um suporte adicional de ligação rápida

CE

IP42
IP65

L=15 m



Model	Cable Type	Length (m)	Price (€)	Qty	Code
1842 15-H05/LED	H05VV-F	15+1	385,00	1	018420821

1846R-LED/BM

lâmpadas LED

12-24V - AC-DC



Model	Price (€)	Qty	Code
1846LED/BM R	106,00	1	018460331

1843

enrolador de cabo elétrico automático, com cabo 2x1.5 mm²

- cabo H05VV-F 2x1,5 mm²
- com interruptor de proteção térmica
- comprimento do cabo enrolado: 15 m
- comprimento do cabo fora do tambor: 1 m
- fornecido sem cabo de entrada
- mecanismo de cremalheira pode ser desativado para manter o cabo puxado
- potência máx. (cabo enrolado): 1300W (230V-20°C)
- potência máx. (cabo desenrolado): 2300W (230V-20°C)
- fornecido com suporte giratório 180° e um suporte adicional de ligação rápida

CE

IP42



Model	Cable Type	Length (m)	Price (€)	Qty	Code
1843 15-H05	H05VV-F	15+1	257,00	1	018430215

1844

enrolador de cabo elétrico automático, com cabo 3Gx1.5 mm²

- cabo 3Gx1.5 mm²
- com interruptor de proteção térmica
- comprimento do cabo fora do tambor: 1 m (exceto for 1844 30-H05, 2 m)
- fornecido sem cabo de entrada
- mecanismo de cremalheira pode ser desativado para manter o cabo puxado
- potência máx. (cabo enrolado): 1500W (230V-20°C)
- potência máx. (cabo desenrolado): 2500W (230V-20°C)
- fornecido com suporte giratório 180° e um suporte adicional de ligação rápida

CE

IP42



Model	Cable Type	Length (m)	Price (€)	Qty	Code
1844 10-H05	H05VV-F	10+1	229,00	1	018440310
1844 15-H05	H05VV-F	15+1	251,00	1	018440315
1844 15-H07	H07RN-F	14+1	273,00	1	018440317
1844 30-H05	H05VV-F	30+2	482,00	1	018440330

1844SCK

enrolador de cabo elétrico automático, com cabo 3Gx1.5 mm² e tomada tipo SCHUKO

- cabo 3Gx1.5 mm²
- com interruptor de proteção térmica
- comprimento do cabo fora do tambor: 1 m
- cabo de entrada 1,5 m com tomada tipo SCHUKO
- mecanismo de cremalheira pode ser desativado para manter o cabo puxado
- potência máx. (cabo enrolado): 1500W (230V-20°C)
- potência máx. (cabo desenrolado): 2500W (230V-20°C)
- fornecido com suporte giratório 180° e um suporte adicional de ligação rápida

CE

IP42



L=15 m



Model	Cable Type	Length (m)	Price (€)	Qty	Code
1844 15-H05/SCK	H05VV-F	15+1	262,00	1	018440316
1844 15-H07/SCK	H07RN-F	14+1	284,00	1	018440318

1845

enrolador de cabo elétrico automático, com cabo 3Gx2.5 mm²

- cabo 3Gx2.5 mm²
- com interruptor de proteção térmica
- comprimento do cabo fora do tambor: 1 m (exceto for 1845 25-H07RN-F, 1.5 m)
- fornecido sem cabo de entrada
- mecanismo de cremalheira pode ser desativado para manter o cabo puxado
- potência máx. (cabo enrolado): 2000W (230V-20°C)
- potência máx. (cabo desenrolado): 3000W (230V-20°C)
- fornecido com suporte giratório 180° e um suporte adicional de ligação rápida

CE

IP42



Model	Cable Type	Length (m)	Price (€)	Qty	Code
1845 12-H05	H05VV-F	12+1	520,00	1	018450365
1845 15-H07	H07RN-F	15+1	520,00	1	018450367
1845 25-H07	H07RN-F	25+1,5	655,00	1	018450377

1846

enrolador de cabo elétrico automático, com cabo 4Gx1.5 mm²

- cabo 4Gx1.5 mm²
- sem interruptor de proteção térmica
- comprimento do cabo fora do tambor: 1 m
- fornecido sem cabo de entrada
- mecanismo de cremalheira pode ser desativado para manter o cabo puxado
- potência máx. (cabo enrolado): 1400W (230V-20°C)
- potência máx. (cabo desenrolado): 1900W (230V-20°C)
- fornecido com suporte giratório 180° e um suporte adicional de ligação rápida

CE

IP42



Model	Cable Type	Length (m)	Price (€)	Qty	Code
1846 10-H05	H05VV-F	10+1	278,00	1	018460405
1846 10-H07	H07RN-F	10+1	288,00	1	018460407
1846 15-H05	H05VV-F	15+1	288,00	1	018460415



1847

enrolador de cabo elétrico automático, com cabo 4Gx2.5 mm²

- cabo 4Gx2.5 mm²
- sem interruptor de proteção térmica
- comprimento do cabo fora do tambor: 1 m
- fornecido sem cabo de entrada
- mecanismo de cremalheira pode ser desativado para manter o cabo puxado
- potência máx. (cabo enrolado): 2000W (230V-20°C)
- potência máx. (cabo desenrolado): 2700W (230V-20°C)
- fornecido com suporte giratório 180° e um suporte adicional de ligação rápida

CE

IP42



		L m	€		
1847 10-H05	H05VV-F	10+1	299,00	1	018470420
1847 15-H07	H07RN-F	15+1	560,00	1	018470427

1848

enrolador de cabo elétrico automático, com cabo 5Gx1.5 mm²

- cabo 5Gx1.5 mm²
- sem interruptor de proteção térmica
- comprimento do cabo fora do tambor: 1 m
- fornecido sem cabo de entrada
- mecanismo de cremalheira pode ser desativado para manter o cabo puxado
- potência máx. (cabo enrolado): 1400W (230V-20°C)
- potência máx. (cabo desenrolado): 1900W (230V-20°C)
- fornecido com suporte giratório 180° e um suporte adicional de ligação rápida

CE

IP42



		L m	€		
1848 10-H05	H05VV-F	10+1	311,00	1	018480510
1848 15-H07	H07RN-F	15+1	595,00	1	018480517

1852R1750

ferro de indução portátil



CE

- aquecimento e desaperto de parafusos, eixos e rolamentos sem recurso a chama
- permite o aquecimento de qualquer tipo de metal ferromagnético

Equipamento standard:

- duas ponteiros frontais, Ø 19 e 26 mm, para desaperto de porcas
- uma ponteira plana para aquecimento de superfícies
- uma ponteira flexível, 800 mm
- estojo em plástico

Características técnicas:

- voltagem entrada: 230V AC, 50/60 Hz
- amperagem entrada: máx. 7.5 A
- potência: máx. 1.75 kW

EQUIPAMENTO OPCIONAL

Ponteiras disponíveis noutras dimensões

VANTAGENS

- Poupança de tempo: aquecimento rápido, extremamente preciso
- Segurança: sem produção de chamas, segurança máxima do operador
- Funcional: possibilidade de utilização com uma mão, fácil troca de bobinas

ÁREAS DE APLICAÇÃO

- Indústria automóvel
- Manutenção industrial
- Indústria aeronáutica
- Indústria naval
- Indústria petroquímica

1852R1750	€	1.730,00	1	018520175
-----------	---	----------	---	-----------

480x370x130 mm - 4,5 kg

1852S-CNT

ponteira de contacto



1852S-CNT	€	130,00	1	018520520
-----------	---	--------	---	-----------

1852S-CC

ponteira de colher



1852S-CC	€	104,00	1	018520521
----------	---	--------	---	-----------

1852S-KR/CNT

kit peças de substituição para ponteira de contacto



1852S-KR/CNT	€	56,50	1	018520522
--------------	---	-------	---	-----------

1852S-L

ponteiras laterais



	Ø mm	M	L mm	€		
1852S-L 19	19	M6	220	52,50	1	018520501
1852S-L 20	20	M8	220	52,50	1	018520502
1852S-L 23	23	M10	220	52,50	1	018520503
1852S-L 26	26	M12	220	52,50	1	018520504
1852S-L 32	32	M16	220	52,50	1	018520505
1852S-L 38	38	M20	220	60,00	1	018520506
1852S-L 45	45	M22	220	66,00	1	018520507

1852S-F

ponteiras frontais



	Ø mm	M	L mm	€		
1852S-F 19	19	M6	220	52,50	1	018520508
1852S-F 20	20	M8	220	52,50	1	018520509
1852S-F 23	23	M10	220	52,50	1	018520510
1852S-F 26	26	M12	220	52,50	1	018520511
1852S-F 32	32	M16	220	52,50	1	018520512
1852S-F 38	38	M20	220	60,00	1	018520513
1852S-F 45	45	M22	220	64,00	1	018520514

1852S-FLESS

ponteira flexível



	L mm	€		
1852S-FL750	750	38,50	1	018520519
1852S-FLESS	800	98,50	1	018520515
1852S-FL1000	1000	126,00	1	018520517
1852S-FL1500	1500	149,00	1	018520518

1852 S-PIATTE

ponteira plana



1852S-PIATTE	€	60,00	1	018520516
--------------	---	-------	---	-----------





SOLDADURA



APARELHOS DE SOLDAR INVERTER

Aparelhos de soldar inverter fáceis de utilizar com excelentes características de soldadura para todos os tipos de elérodos. Com controlo de sobretensão e sobreaquecimento e função antiaderente do eléetrodo. Compactos e leves, ideais para trabalhos de manutenção doméstica, carpintaria leve e trabalhos de manutenção.



ACESSÓRIOS DE SOLDADURA

3) Acessórios de soldadura
Uma vasta gama de acessórios para trabalhos de soldadura.



MÁSCARAS DE SOLDADURA

A Beta disponibiliza várias máscaras com LCD de escurecimento automático adequadas para diferentes tipos de soldadura: soldadura por eléetrodo, soldadura MIG/MAG, TIG e plasma. A proteção e o conforto são garantidos pelo cumprimento integral de todas as normas de segurança em vigor.



APARELHOS DE SOLDAR A GÁS

Aparelhos de soldadura e acessórios concebidos para pequenos trabalhos de manutenção e trabalhos de microeletrónica. Além dos aparelhos de soldar com fio, a Beta também disponibiliza diversas soluções a gás butano que permitem que os trabalhos de soldadura sejam realizados ao ar livre e sem eletricidade.

1808

ferro de soldar bivalente, fornecido com uma ponteira direita em aço 1824R8



W	V	€	🔌	📦
20/130	230	95,00	1	018080001

1812 150

ferro de soldar instantâneo



W	V	€	🔌	📦
150	230	136,00	1	018120015

1814M

ferros de soldar com pontas de aço



W	V	€	🔌	📦
25	230	76,50	1	018140225
30	230	80,50	1	018140230
40	230	87,50	1	018140240

1820

ferros de soldar



Model	W	V	€	🔌	📦
1820 30	30W	230V	56,50	1	018200003
1820 60	60W	230V	64,50	1	018200006
1820 80	80W	230V	91,50	1	018200008

1822

ferros de soldar de alta performance



Model	W	V	€	🔌	📦
1822 120	120W	230V	139,00	1	018220012
1822 180	180W	230V	148,00	1	018220018
1822 320	320W	230V	184,00	1	018220032

1823 60

aparelho de soldar digital fornecido com ferro de soldar

- Amplitude térmica: 160 °C + 480 °C com ±1% precisão
- Modo de memorização concebido para guardar a temperatura seleccionada ao desligar o aparelho
- 3 teclas de selecção rápida (200-300-400 °C).



W	€	🔌	📦
60	540,00	1	018230060

1823R/60

ferro de soldar sobresselente para artigo 1823 60



Model	W	€	🔌	📦
1823R 60	60W	107,00	1	018230066

1824R

ponteiras de substituição para ferros de soldar

Model	W	V	€	🔌	📦
1824R 08	8W	230V	40,50	1	018240100
1824R 12	12W	230V	5,50	1	018240301
1824R 14-M25	25W	230V	5,50	1	018240152
1824R 14-M30	30W	230V	5,50	1	018240153
1824R 14-M40	40W	230V	5,50	1	018240154
1824R 20	20W	230V	7,20	1	018240302
1824R 60	60W	230V	7,20	1	018240303
1824R 80	80W	230V	10,50	1	018240304
1824R 120-180	120-180W	230V	84,50	1	018240305
1824R 320	320W	230V	108,00	1	018240307
1824R ST-60	60W	230V	14,90	1	018240308

1825B

fião de soldar em latão com antioxidante

- 1 mm²; 250 g
- Sn 99.3%; Cu 0.7%



Model	W	V	€	🔌	📦
1825B	1 mm ²	250g	79,50	1	018250251

1827

máquina de soldar a gás, ajustável



Model	W	V	€	🔌	📦
1827	24V	60W	171,00	1	018270001

1827PC

bicos cónicos para artigo 1827

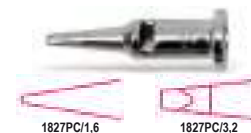

Model	W	V	€	🔌	📦
1827PC 1,6	1,6mm	24V	35,50	1	018270501
1827PC 3,2	3,2mm	24V	35,50	1	018270502

1827PCL

ponteiras tipo faca para artigo 1827



Model	W	V	€	🔌	📦
1827PCL 2,4	2,4mm	24V	35,50	1	018270503



1827PFL

peça de substituição para artigo 1827



1827PFL € 35,50 1 018270504

1827/K

aparelho de soldar a gás com 7 acessórios em caixa de polietileno macio



- Potência: 30 watts a 125 watts
- Temperatura dos bicos pode ser ajustada entre 250 °C e 500 °C
- Regulador de fluxo do gás
- Tempo de aquecimento: 15 segundos
- Tanque contém gás para operar 120 minutos sem paragens
- Tanque claro para visualizar o nível de gás
- Pode ser cheio com gás butano

1827/K € 264,00 1 018270100

1827F

maçarico recarregável de gás butano

- Depósito 35 g
- Três bicos intercambiáveis: 550 °C; 1000 °C; 1300 °C
- Fornecido com base e estojo rígido



1827F € 187,00 1 018270200

1830T

bomba dessoldadora com bico anti-estático em material plástico (PTFE)



L mm € 20,10 5 018300021

1860BH/120A

aparelho inverter DC para soldadura MMA com eléctrodos rútilo, básico e aço inoxidável, compacto e de fácil transporte

Arc force, hot start, anti-stick e proteção termostática

Corrente regulação: 10+120A
Potência entrada: 1x230V
Factor utilização (40 °C):
25% - 120 A
50% - 80 A
100% - 60 A
Proteção: IP22S
Eléctrodos: Ø 1.6 - 3.2 mm rútilo, básico, aço inoxidável, ferro fundido etc.
fornecido com cabos 16 mm²

CE



1860BH/120A € 416,00 1 018600121

1860BH/160A

aparelho inverter DC para soldadura MMA com eléctrodos rútilo, básico e aço inoxidável, compacto e de fácil transporte

Arc force, hot start, anti-stick e proteção termostática

Corrente regulação: 10+160A
Potência entrada: 1x230V
Factor utilização (40 °C):
25% - 160 A
60% - 100 A
100% - 80 A
Proteção: IP22S
Eléctrodos: Ø 1.6 - 4 mm rútilo, básico, aço inoxidável, ferro fundido etc.
fornecido com cabos 16 mm²

CE



1860BH/160A € 540,00 1 018600161

1860BH/200A

aparelho inverter DC para soldadura MMA com eléctrodos rútilo, básico e aço inoxidável, compacto e de fácil transporte

Arc force, hot start, anti-stick e proteção termostática

Corrente regulação: 10+200A
Potência entrada: 1x230V
Factor utilização (40 °C):
25% - 200 A
60% - 130 A
100% - 100 A
Proteção: IP22S
Eléctrodos: Ø 1.6 - 4 mm rútilo, básico, aço inoxidável, ferro fundido etc.
fornecido com cabos 16 mm²

CE



1860BH/200A € 600,00 1 018600201

1860BH R/CM

fios de terra de substituição para aparelhos de soldar inverter 1860BH-120/160/200A



1860BH R/CM € 57,50 1 018600612

1860BH R/CS

cabos porta-eléctrodos de substituição para aparelhos de soldar inverter 1860BH-120/160/200A



1860BH R/CS € 70,00 1 018600613

1860BHT/160A

aparelho inverter DC para soldadura por elétrodo MMA e TIG, compacto e de fácil transporte

Dispositivos arc force, STICK/TIG (lift arc), hot start, anti-stick e proteção termostática

corrente de ajuste: 10÷160 A
potência de entrada: 1x230 V

fator de utilização (40 °C):

60% - 160 A

100% - 130 A

proteção: IP23S

elétrodos compatíveis: Ø 1.6 - 4 mm, rútilo, básico, aço inoxidável.

Fornecido com cabos 25 mm²

CE



1860BHT/160A	€ 1.050,00	1	018600179
--------------	------------	---	-----------

1860BHT R/CM

firos de terra de substituição para aparelhos de soldadura TIG 1860BHT



1860BHT R/CM	€ 89,00	1	018600616
--------------	---------	---	-----------

1860BHT R/CS

cabos de soldadura para aparelhos de soldadura TIG 1860BHT



1860BHT R/CS	€ 115,00	1	018600617
--------------	----------	---	-----------

1860BHT/T

tocha TIG para aparelhos de soldar TIG 1860BHT
comprimento: 4m
conector: 50 mm²



1860BHT/T	€ 283,00	1	018600615
-----------	----------	---	-----------

1860M

torno de soldadura magnético, regulação rápida

com mordentes basculantes, ideal para fixar componentes de diferentes tamanhos



1860M	L max mm 30	€ 107,00	1	018600301
-------	-------------	----------	---	-----------

1860DM

discos magnéticos para elevação de chapas metálicas
ideais para manuseamento e fixação de chapas metálicas
força magnética constante sobre toda a superfície do disco
pegas com furos para maior facilidade de trabalho na vertical



1860DM 16	kg max 16	€ 61,50	1	018600310
1860DM 40	40	€ 86,50	1	018600311

1860PMIG

alicate multiusos para soldadura MIG



1860PMIG	L mm 215	L1 mm 44	€ 44,00	2	018600350
----------	----------	----------	---------	---	-----------

1860EI

fixador magnético, 90°, para ângulos internos e externos

ideal para bloqueio de peças tubulares ou planas
força magnética de 18 kg,
também para ângulos de 30° e 60°
com furos sextavados para facilitar separação de metal e iman.



1860EI	L mm 165	L1 mm 110	S mm 35	€ 43,00	1	018600290
--------	----------	-----------	---------	---------	---	-----------

1860RG

fixador magnético ajustável, 30°/290°

ideal para bloqueio de peças tubulares ou planas
força magnética de 15 kg, fornecido com uma chave sextavada, de bloqueio do mecanismo de ajuste do ângulo, com pino para fixar ângulo a 30°-45°-90°/270°-180°
com furos sextavados para facilitar separação de metal e iman.



1860RG	L mm 155	S mm 35	€ 69,50	1	018600255
--------	----------	---------	---------	---	-----------

1860SQ

fixador magnético, 45°/90°

ideal para bloqueio de peças tubulares ou planas
27 kg de força magnética
não requer pilhas, efeito ON/OFF através de ímanes basculantes no interior
fácil remoção de aparas com os ímanes na posição OFF



1860SQ	€ 106,00	1	018600210
--------	----------	---	-----------





7041LCD/4S

máscara de soldadura com LCD de escurecimento automático, para soldadura por eléctrodo; MIG/MAG; TIG e plasma.
4 sensores
com filtro TRUE COLOR
alimentação por célula solar e baterias de lítio para vida útil mais longa do filtro LCD

- Visor: 98x80 mm
- Amplitude de escurecimento: 5+8.5/ 9-13, ajustável internamente
- Protecção UV/IR: DIN16
- Tempo de escurecimento: 1/25000 s
- Tempo de clareamento: 0.1-2.0s
- Sensibilidade e tempo de escurecimento ajustáveis
- On/off automáticos
- Modo rebarbar
- Indicador bateria fraca
- Design ergonómico, leve, equilibrado
- Com porca de anel ajustável



CE

7041LCD/4S € 343,00 1 070410001

7041LCD/4S-VE

protector de lente à prova de riscos para item 7041LCD/4S

7041LCD/4S-VE € 8,40 2 070410101

7041LCD/4S-VI

lente interna para item 7041LCD/4S

7041LCD/4S-VI € 4,20 2 070410102

7042LCD

Máscara com LCD de escurecimento automático, para soldadura por eléctrodo; MIG/MAG; TIG e plasma.
Alimentação através de células solares e baterias de lítio para maior durabilidade do filtro LCD

- Área do visor: 98x43 mm
- Escurecimento: DIN 9-13, ajustável externamente
- Protecção UV/IR
- Tempo escurecimento: 1/25000s
- Tempo aclareamento: 0.25-1s
- Sensibilidade e tempo de escurecimento ajustáveis
- On/off automático
- Adequada para rebarbar
- Forma optimizada para que o utilizador respire mais facilmente com a máscara colocada



CE

7042LCD € 240,00 1 070420001

7042LCD/RV

protector anti-riscos para artigo 7042LCD, 7043

7042LCD/RV € 3,75 2 070420101

7042LCD/RV-INT

lente interna para artigo 7042LCD, 7043

7042LCD/RV-INT € 3,30 2 070420102

7043

Máscara com LCD de escurecimento automático, para soldadura por eléctrodo, MIG/MAG, TIG e plasma, alimentação através de células solares

- área do visor: 92x43 mm
- escurecimento: DIN 9-13, ajustável externamente
- protecção UV/IR
- tempo de escurecimento: 1/1000 s
- tempo de aclareamento: 0.1-1.0 s
- tempo de escurecimento ajustável
- on/off automático
- adequada para rebarbar
- forma optimizada para que o utilizador respire mais facilmente com a máscara colocada



CE

7043 € 139,00 1 070430001

REPARAÇÃO DE VEÍCULOS

As nossas ferramentas para reparação de veículos, usadas pelos profissionais mais exigentes, são desenvolvidas e fabricadas para cumprir as normas mais rígidas a nível mundial, e são testadas com regularidade sob as mais difíceis condições de trabalho. Há mais de 50 anos que temos o orgulho de trabalhar de mãos dadas com os melhores, que nos ajudam a melhorar continuamente os nossos produtos e são testemunhas dos mais elevados padrões de qualidade.

As ferramentas de reparação de veículos encontram-se nas seguintes secções:

Diagnóstico	itens 1438 a 1499 itens 1758VT a 1760TMC
Motor	itens 955 a 989A itens 1438 a 1499
Óleo e filtros	itens 1438 a 1499 itens 1877 a 1885
Sistema elétrico	itens 1438 a 1499
Arrancadores	itens 1498BC/12 a 1498/40A
Transmissão	itens 1438 a 1499
Suspensão	itens 1549 a 1569CP
Travões	itens 1438 a 1499
Rodas	itens 955 a 989A
Carroçaria	itens 1302 a 1369 itens 1763 a 1767A
Outros equipamentos	itens 1875LT a 3067
Elevação	itens 3029/2T a 3067/70-13T



1875LT

lavadora de tapetes/estofos

Ideal para limpeza profunda de superfícies têxteis. Dispensa detergente pulverizado sob pressão e aspira-o com a sujidade, deixando as superfícies quase secas

Acessórios fornecidos:

- 1 tubo completo com cabo ergonómico
- 1 unidade dispensadora
- 2 extensões rígidas
- 1 bocal pequeno
- 1 bocal grande
- 6 contraporcas do cabo de alimentação

CE



1875LT	€ 660,00	1	018750000
--------	----------	---	-----------

1875SP/K3

kit de escovas para limpeza de tecidos

- 1 escova plana Ø 48 mm
- 1 escova plana Ø 100 mm
- 1 escova redonda Ø 90 mm
- chave de impacto 1/4"

1/4



ISO 1173 E 6,3

1875SP/K3	€ 21,20	1	018750010
-----------	---------	---	-----------

1877

aparador de óleo com rodas e depósito de 90 l

- indicador do nível
- depósito de grande diâmetro com grelha de retenção; capacidade 12 l
- purga do depósito pneumático através de tubo com 1.8 m
- tabuleiro para ferramentas

CE



1877	€ 820,00	1	018770008
------	----------	---	-----------

1877A

aparador de óleo / aspirador com rodas, depósito de 90 l e antecâmara

- indicador do nível
- depósito de grande diâmetro com grelha de retenção; capacidade 12 l
- antecâmara transparente: capacidade 9.5 l
- tubo de aspiração 1.8 m
- purga do depósito pneumático através de tubo com 1.8 m
- tabuleiro para ferramentas

Acessórios standard:

- 1 sonda rígida, Ø 5x700 mm
- 1 sonda flexível, Ø 5x700 mm
- 1 sonda rígida, Ø 6x600 mm
- 1 sonda flexível, Ø 6x700 mm
- 1 sonda rígida, Ø 7x700 mm
- 1 sonda flexível, Ø 7x700 mm
- 1 sonda flexível, Ø 8x700 mm
- adaptadores para VW, BMW, CITROËN

CE



1877A	€ 1.450,00	1	018770080
-------	------------	---	-----------

1877F

aparador de óleo para garrafas de 1 l

- capacidade até 4 garrafas em simultâneo
- fornecido com 2 garrafas 2 l



H mm	L mm	P mm	€	1	018770100
405	270	240	112,00		

1877P

recuperador de óleo, com rodas, com depósito de polietileno

- capacidade do depósito: 40 l
- aparadeira de grandes dimensões em PP
- indicador do nível de óleo
- descarga pneumática



H min-Max mm	H1 mm	€	1	018770180
1030-1630	900 40	498,00		

1878 2

Tabuleiro de recolha de fluidos

- capacidade máxima: 2 L
- indicada para mudança de óleo em scooters



L	H mm	€	1	018780002
2	85	16,70		

1878 3

reservatório colector de óleo, para os cubos das rodas de pesados Com aparador de gotas



L	€	1	018780003
3	25,00		

1878 4

Tabuleiro de recolha de fluidos portátil

- indicado para motociclos
- capacidade máxima: 4 L
- salpicos reduzidos



L	H mm	€	1	018780004
4	100	35,50		

1878 8

Tabuleiro de recolha de fluidos

- altura apropriada para motociclos
- capacidade máxima: 8 L



1878 8	l	H mm	€	1	018780008
	8	110	18,90		

1878 11

reservatório colector de fluido

- Capacidade máxima: 11 l
- Válvula drenagem de fluidos
- Revestimento interior para prevenir fugas de fluido durante o transporte



1878 11	l	€	1	018780011
	11	42,00		

1878 30

reservatório colector de fluido

- Capacidade máxima: 30 l
- Grelha anti-salpicos
- Equipado com 4 rodas giratórias

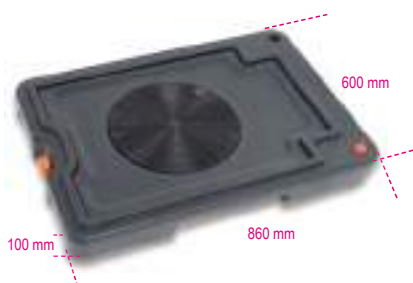

1878 30	l	€	1	018780030
	30	163,00		

1879

extractor manual/pneumático de fluido 9.5 l



1879 9,5	€	1	018790001
	353,00		

1879 6

extrator de líquidos com operação manual, 6 l



1879 6	€	1	018790000
	258,00		

1879R/K4

jogo de 4 tubos de substituição para extractor de líquidos 1879



1879R/K4	€	1	018790504
	68,50		

1879/FUEL

Extrator de fluidos com operação manual 6 L

utilizado para hidrocarbonetos



1879/FUEL	l	€	1	018790010
	6	153,00		

1880

bomba manual para bidons

- para óleo
- não utilizar com líquidos aquosos, solventes ácidos, diesel, gasolina e similares
- fornecida com conexão para bidões, tubo telescópico e ponteira
- para utilização com bidões de 60, 100 e 200 l



1880	gr	€	1	018800001
	240	66,50		

1880ADB

bomba manual para bidons AdBlue

- 5 litros fornecidos a cada vinte voltas
- extensões até 1,20 m
- 1 conexão para bidons de passo fino
- 1 conexão para bidons de passo grosso



1880ADB	€	1	018800101
	155,00		

1881

bomba pneumática, ratio 3:1

CE



1881	l/min	€	1	018810001
	18	570,00		

1882N

pistola de óleo com bico flexível e apanhagotas automático

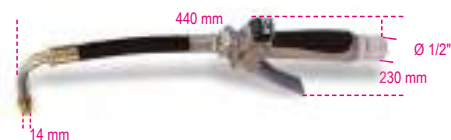

1882N	€	1	018820110
	171,00		

1883N

contador digital para óleo



1883N	€	1	018830036
	241,00		

1883NC

Bocal macho-macho, 1/2,
para refs. 1882N e 1883N



1883NC € 15,00 1 018830135

1884

chave para filtros de óleo
de caixas de velocidades e diferenciais
manuais e automáticos

Com 12 adaptadores para ligação directa



1884 € 560,00 1 018840010

AT-101	FORD
AT-102	UNIVERSAL (Bmw, Honda, Nissan...)
AT-103	VW-AUDI
AT-104	VW-AUDI-PORSCHE
AT-105	VW-AUDI-MINI COOPER
AT-106	MERCEDES
AT-107	DSG
AT-108	VW-AUDI CVT
AT-109	VOLVO
AT-110	TOYOTA-LEXUS
AT-111	SKODA
AT-112	VW Passat/Tiguan <2007

1884/C12

jogo de adaptadores para artigo 1884



1884/C12 € 208,00 1 018840100

1884N/C8

jogo 8 adaptadores para o item 1884

Inclui:

- 1 adaptador para Infiniti, 7 velocidades, M8x1.0
- 1 adaptador para Honda, Hyundai, Kia 5x8x200 mm
- 1 adaptador para Skoda M18x1.5
- 1 adaptador para Mini M14x1.5
- 1 adaptador para Nissan M10x1.5
- 1 adaptador para Nissan Juke M12x1.25
- 1 adaptador para GM M12x1.75
- 1 adaptador para veículos grupo VAG, 7 velocidades



1884N/C8 € 136,00 1 018840200

200x145x40 mm - 400 g

1889N

base em aço para movimentação e
armazenagem de bidões 2 200-l



1889N € 930,00 1 018890220

1889CF

chave universal para bidões

- 1 sextavado fêmea Ø 38 mm
- 1 perfil de 4 setores Ø 42 mm
- 1 lâmina 17x7 mm



1889CF L mm 270 € 39,50 1 018890010

1885

Estação de manutenção para caixa de
velocidades automáticas

Permite que o processo de limpeza seja feito de forma segura em todas as caixas de velocidades automáticas. As manutenções evitam danos causados pelo óleo degradado nas caixas de velocidades automáticas, prevenindo: excesso de ruído na caixa de velocidades, engrenagens, cheias e engatadas, tempo de mudança de velocidade longo.



Funcionalidades

Automática

Processo seguido passo a passo com banco de dados integrado
Permite igualar a quantidade de óleo inserido com o utilizado,
garantindo assim a quantidade adequada de óleo no sistema.
Caudalímetro para inspeção visual da quantidade de óleo.
Relatório de operação.

ESPECIFICAÇÕES AUTOMÁTICAS

Injeção de óleo (opcional)
Sistema de lavagem da caixa de velocidades
Retirar o óleo do depósito
Retirar o óleo do conversor
Injeção de óleo no conversor

Especificações técnicas

Alimentador: 220 V 50 Hz

2 balanças eletrônicas, resolução +/- 10 g
Cartão eletrônico com ecrã gráfico iluminado

1885 € 9.900,00 1 018850010



1885/C1

kit de acessórios para caixas de velocidades automáticas para item 1885

Inclui:

- 1885/C1-R1 acessórios para transmissão Land Rover Freelander
- 1885/C1-R2 acessório para transmissão DP0
- 1885/C1-R3 acessório para transmissão ZF 9HP
- 1885/C1-R4 sonda para transmissão ZF 9HP
- 1885/C1-R5 sonda para transmissão Mercedes
- 1885/C1-R6 acessórios para transmissão AISIN TG82
- 1885/C1-R7 acessórios para transmissão AISIN TG81
- 1885/C1-R8 acessórios para transmissão Renault-Nissan



1885/C1 € 855,00 1 018850110

1885/C1-R1

acessórios para transmissão Land Rover Freelander para item 1885
lc01430



1885/C1-R1 € 74,00 1 018850111

1885/C1-R2

acessório para transmissão DP0 para item 1885
lc0990



1885/C1-R2 € 129,00 1 018850112

1885/C1-R3

acessório para transmissão ZF 9HP para item 1885
lc0992



1885/C1-R3 € 144,00 1 018850113

1885/C1-R4

sonda para transmissão ZF 9HP para item 1885
lc0192



1885/C1-R4 € 80,00 1 018850114

1885/C1-R5

sonda para transmissão Mercedes para item 1885
K-A-M



1885/C1-R5 € 133,00 1 018850115

1885/C1-R6

acessórios para transmissão AISIN TG82 para item 1885
lc01820



1885/C1-R6 € 142,00 1 018850116

1885/C1-R7

acessórios para transmissão AISIN TG81 para item 1885
lc0150



1885/C1-R7 € 142,00 1 018850117

1885/C1-R8

acessórios para transmissão Renault-Nissan para item 1885
lc02150



1885/C1-R8 € 142,00 1 018850118

1885/C2

kit de acessórios para caixas de velocidades automáticas para item 1885

Inclui:

- 1885/C2-R1 acessórios para transmissão Audi 8HP
- 1885/C2-R2 acessórios para transmissão sem permutador ZF 9HP
- 1885/C2-R3 acessório para transmissão Audi 0KC
- 1885/C2-R4 acessórios para transmissão AG4-ZF 4HP
- 1885/C2-R5 acessórios para transmissão FIAT
- 1885/C2-R6 acessórios para transmissão Audi Q5-Q7
- 1885/C2-R7 acessório para transmissão Audi 0B5



1885/C2 € 695,00 1 018850120

1885/C2-R1

acessórios para transmissão sem permutador Audi 8HP para item 1885
lc0993



1885/C2-R1 € 139,00 1 018850121

1885/C2-R2

acessórios para transmissão ZF 9HP para item 1885
lc0860



1885/C2-R2 € 90,50 1 018850122

1885/C2-R3

acessório para transmissão Audi 0KC para item 1885
lc02020



1885/C2-R3 € 142,00 1 018850123

1885/C2-R4

acessórios para transmissão AG4-ZF 4HP para item 1885
lc0750



1885/C2-R4 € 123,00 1 018850124

1885/C2-R5

acessórios para transmissão FIAT para item 1885
lc0061



1885/C2-R5 € 53,50 1 018850125

1885/C2-R6

acessórios para transmissão Audi Q5-Q7 para item 1885
lc0680



1885/C2-R6 € 133,00 1 018850126

1885/C2-R7

acessórios para transmissão Audi 0B5 para item 1885
lc01720



1885/C2-R7 € 80,00 1 018850127

1885/C3

kit de acessórios para caixas de velocidades automáticas para item 1885

Inclui:

- 1885/C3-R1 acessórios para transmissão Mercedes DSG
- 1885/C3-R2 acessório para transmissão POWERSHIFT
- 1885/C3-R3 acessórios para transmissão Toyota IQ
- 1885/C3-R4 acessórios para transmissão Mazda
- 1885/C3-R5 acessórios para transmissão Renault Laguna-Esp
- 1885/C3-R6 acessórios para transmissão Nissan Juke
- 1885/C3-R7 acessórios para transmissão AISIN TF71 FV
- 1885/C3-R8 acessórios para transmissão AISIN TF71 FP
- 1885/C3-R9 acessórios para transmissão AISIN TF71 FO
- 1885/C3-R10 acessórios para transmissão AISIN TF71 FS



1885/C3 € 1.230,00 1 018850130

1885/C3-R1

acessórios para transmissão Mercedes DSG para item 1885
lc0191



1885/C3-R1 € 142,00 1 018850131

1885/C3-R2

acessórios para transmissão POWERSHIFT para item 1885
lc0190



1885/C3-R2 € 142,00 1 018850132

1885/C3-R3

acessórios para transmissão Toyota IQ para item 1885
lc0991



1885/C3-R3 € 142,00 1 018850133

1885/C3-R4

acessórios para transmissão Mazda para item 1885
lc02130



1885/C3-R4 € 142,00 1 018850134

1885/C3-R5

acessórios para transmissão Renault Laguna-Esp para item 1885
lc02150



1885/C3-R5 € 142,00 1 018850135

1885/C3-R6

acessórios para transmissão Nissan Juke para item 1885
lc02140



1885/C3-R6 € 142,00 1 018850136

1885/C3-R7

acessórios para transmissão AISIN TF71 FV para item 1885
lc01420



1885/C3-R7 € 142,00 1 018850137

1885/C3-R8

acessórios para transmissão AISIN TF71 FP para item 1885
lc001420/1



1885/C3-R8 € 142,00 1 018850138

1885/C3-R9

acessórios para transmissão AISIN TF71 FO para item 1885
lc001420/2



1885/C3-R9 € 142,00 1 018850139

1885/C3-R10

acessórios para transmissão AISIN TF71 FS para item 1885
lc001420/3



1885/C3-R10 € 142,00 1 018850140

1885/XC60

acessórios para transmissão Volvo XC60 para artigo 1885



1885/XC60 € 153,00 1 018850151

1893/134A

Estação de carregamento automático para ar condicionado a gás R134a

Modelo automático, completo com base de dados de carros/camiões com quantidades de gás, quantidades e tipos de óleo do compressor, software de autodiagnóstico para trabalhos de manutenção de rotina.

Base de dados pode ser atualizada através do software. A máquina pode funcionar em modo manual (com a condição de ser controlada por um utilizador) e em modo automático (não é necessário o controlo do utilizador).



R134A (250 ml)



FUNCIONALIDADES

Automático
Base de dados de carros/camiões com quantidades de gás, quantidades e tipos de óleo do compressor
Recuperação automática do gás
Compensação da quantidade de gás recarregada nas tubagens
Descarga automática de gases não condensados
Relatório de erros e manutenção necessária
Medidor ø 80 mm
Leitura digital

ESPECIFICAÇÕES TÉCNICAS

Tanque de gás: 15kg
Bomba de vácuo: 75 l/min
Balança eletrónica: 50kg
Cartão eletrónico com iluminação
Taxa de recuperação: 500 rpm
Alimentação: 220 V

1893/134A € 7.200,00 1 018930001

1893/1234YF

Estação de carregamento automático para ar condicionado a gás R1234yf

Modelo automático, completo com base de dados de carros/camiões com quantidades de gás, quantidades e tipos de óleo do compressor, software de autodiagnóstico para trabalhos de manutenção de rotina.

Base de dados pode ser atualizada através do software. A máquina pode funcionar em modo manual (com a condição de ser controlada por um utilizador) e em modo automático (não é necessário o controlo do utilizador).



CE



1234YF (250 ml)

FUNCIONALIDADES

Automático
Base de dados de carros/camiões com quantidades de gás, quantidades e tipos de óleo do compressor
Recuperação automática do tubo de gás
Compensação da quantidade de gás recarregada em tubulações
Descarga automática de gases não condensados
Relatório de erros e manutenção necessária
Medidor Ø 80 mm

ESPECIFICAÇÕES TÉCNICAS

Tanque de gás: 15kg
Bomba de vácuo: 75 l/min
Balança eletrônica: 50kg
Cartão eletrônico com iluminação
Taxa de recuperação: 500 rpm
Alimentação: 220 V

1893/1234YF 7.450,00 € 1 018930012

1893TR/134A

R134a líquido de deteção de fugas para compressores híbridos A/C



1893TR/134A 50,50 € 1 018930901

1893TR/1234YF

R1234yf líquido de deteção de fugas para compressores híbridos A/C



1893TR/1234YF 58,00 € 1 018930902

1893TR/CI

líquido de deteção de fugas para compressores híbridos A/C



1893TR/CI 60,00 € 1 018930903

1895G

Gerador de sinal para eletro injetores (gasolina e GPL) e válvulas selenoides

Permite testar componentes como:

- Válvulas selenoides EGR
- Eletro injetores de motores (gasolina e GPL)
- Compressores de ar condicionados de nova geração



CE

Vantagens

- Permite saber se a peça está a trabalhar manualmente (mecanicamente)
- Permite uma limpeza mais eficiente das peças, em conjunto com os tanques de limpeza ultrassónicos, a peça é controlada eletronicamente durante a lavagem
- Importante para testes em ar condicionados, permite verificar a eficiência do compressor e da válvula de controlo.

Caraterísticas:

- Injetor de gasolina e gpl:
 - Número de saídas: 4
 - Duração: 1-60s
 - Tempo de funcionamento: 5-10ms
 - Frequência: 1-10 Hz
 - PWM
 - Número de saídas: 1
 - Duração: 1-60 min
 - Automático ou manual
 - Ciclo de trabalho: 10% - 85%
 - Frequência: 120-250 Hz
- Inclui 4 conectores com terminais fêmea FASTON
Alimentação: 110-220 V
Dimensões: 334x240x74mm
Peso: 4Kg

1895G 2.150,00 € 1 018950800

1895/S

Acessório para tanques de limpeza ultrassónicos 1895

Permite o posicionamento correto dos injetores no tanque ultrassónico durante a limpeza.

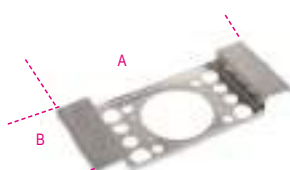

1895S 127,00 € 1 018950501

1895 6

tanque de limpeza ultrassónico, 6 l

com função especial de degas (eliminação de bolhas)



CE

- A limpeza ultrassónica processa-se através do aquecimento do fluido para uma boa limpeza das peças de substituição, componentes metálicos em geral (injetores, carburadores, válvulas etc.)
- Ecrã digital para seleção da temperatura e tempo de limpeza.
- Dois modos de limpeza: "suave" e "normal".
- Para limpeza normal, utilize apenas água a uma temperatura de 50/60 °C
- Para uma limpeza mais precisa, adicione detergentes não-espumosos específicos para tanques ultrassónicos
- Ao utilizar o modo de degas acelera a libertação de ar no tanque, melhorando, assim, a eficiência da limpeza ultrassónica.

CARACTERÍSTICAS TÉCNICAS

Capacidade do tanque: 6 l
Torneira de purga
Potência: 150 W
Potência de aquecimento: 300 W
Amplitude térmica: 0+80 °C
Intervalo de tempo de limpeza: 0-99 minutos
Frequência: 40 kHz
Voltagem: 220/230V
Dimensões gerais: 330x180x310 mm
Dimensões do tanque: 300x155x150 mm
Dimensões do cesto: 250x105x100 mm
Capacidade máxima: 5.5 kg

1895 6 830,00 € 1 018950060

1895 13

tanque de limpeza ultrassónico, 13 l

com função especial de degas (eliminação de bolhas)



CE

- A limpeza ultrassónica processa-se através do aquecimento do fluido para uma boa limpeza das peças de substituição, componentes metálicos em geral (injetores, carburadores, válvulas etc.)
- Ecrã digital para seleção da temperatura e tempo de limpeza.
- Dois modos de limpeza: "suave" e "normal".
- Para limpeza normal, utilize apenas água a uma temperatura de 50/60 °C
- Para uma limpeza mais precisa, adicione detergentes não-espumosos específicos para tanques ultrassónicos
- Ao utilizar o modo de degas acelera a libertação de ar no tanque, melhorando, assim, a eficiência da limpeza ultrassónica.

CARACTERÍSTICAS TÉCNICAS

Capacidade do tanque: 13 l
Torneira de purga
Potência: 300 W
Potência de aquecimento: 400 W
Amplitude térmica: 0+80 °C
Intervalo de tempo de limpeza: 0-99 minutos
Frequência: 40 kHz
Voltagem: 220/230V
Dimensões gerais: 350x325x320 mm
Dimensões do tanque: 325x235x145 mm
Dimensões do cesto: 257x185x100 mm
Capacidade máxima: 12 kg

1895 13 1.290,00 € 1 018950130

1895 27

tanque de limpeza ultrasónico,
27 l

com função especial de desgaseificação



CE

- A limpeza ultrasónica baseia-se no aquecimento do fluido para limpar eficazmente peças de substituição e componentes metálicos em geral (carburadores, válvulas etc.)

- Monitor digital para seleção da temperatura e tempo de limpeza

- Dois modos de limpeza: "suave" e "normal"

- Para limpeza normal, utilize apenas água a uma temperatura de 50/60 °C

- Para uma limpeza mais profunda, adicione uma solução de detergente sem formação de espuma específica para tanques ultrasónicos

- A utilização do modo desgaseificação acelera a movimentação de ar através do tanque, melhorando a eficiência da limpeza ultrasónica

CARACTERÍSTICAS TÉCNICAS

Capacidade do tanque: 27 l

Torneira de purga

Potência: 500 W

Potência de aquecimento: 500 W

Intervalo temperatura: 0+80 °C

Tempo de limpeza: 0-99 minutos

Frequência: 40 kHz

Potência entrada: 220/230V

Dimensões: 530x330x380 mm

1895 27 25 1.790,00 1 018950270

1895/RC

grelha para tanques de limpeza ultrasónicos
1895



	L	L1	A	€		
	mm	mm	mm			
1895/RC6	250	105	100	52,50	1	018950506
1895/RC13	257	185	100	83,00	1	018950513
1895/RC27	450	250	150	140,00	1	018950527

9881U



9881U 1 (1-2) 567
9881U 1 (3) 567

9882R



9882R 1 (1-2) 567
9882R 1 (3) 567

1897

Estação de decapagem por jato de areia

Recomendado para trabalhos de limpeza e acabamento em diversos materiais (metal, plástico, vidro, cerâmica, madeira, etc.). Caixa em chapa de aço reforçado, tornando-a mais robusta e segura.

Caixa equipada com:

- porta com fecho magnético
- tampo em chapa perfurada
- ligação padrão para aspiradores ø 36 mm
- janela de visualização em policarbonato, 6mm
- iluminação Led
- circuito pneumático (tomada de ar comprimido)
- pistola de jato de areia



CE

Características Técnicas

Dimensões: 600x520x320 mm

Dimensões no total: 660x530x320 mm

Peso: 38 kg

Bancada: chapa perfurada

Iluminação: LED

Consumo de ar: 340 l/min em 7 atm

Alimentação: 220 V - 50 Hz

1897 3.980,00 1 018970066

1897/CRB

Areia (corindo) para estação de decapagem
1897 em saco de 25 kg



1897CRB 200,00 1 018970101

1897/G

Gralha para estação de decapagem 1897
em saco de 25 kg



1897G 161,00 1 018970104

1897/MV

Microesferas de vidro para estação de
decapagem 1897 em saco de 25 kg



1897MV 264,00 1 018970103

1898/K40

Tanque manual de limpeza por recirculação de
componentes mecânicos, com aquecimento
de fluidos e bactérias

- sem os custos de eliminação de solventes ou hidrocarbonetos

- utilizando o detergente ecológico Beta, à base de enzimas e bactérias, permite que os resíduos de óleo sejam removidos e eliminados dos componentes mecânicos

- a função enzimática ajuda a separar a parte oleosa da parte sólida suja; as bactérias transformam essa parte em dióxido de carbono e água, mantendo assim o detergente regenerado



CE

Equipamento:

- escova de cerdas longas com ligação para mangueira

- com dupla ligação, para operar à esquerda e à direita

- grelha perfurada em aço inoxidável

- rodas com travões

- indicação da temperatura de funcionamento e alerta de níveis mínimos

ACESSÓRIOS:

- 2 latas 20 l de detergente ecológico e 2 packs de bacteria

DADOS TÉCNICOS

- Capacidade máxima da bomba: 10 l/min

- Capacidade do tanque: 40 l

- Temperatura de funcionamento: +5°C ÷ +40°C

- Dimensões: 900 x 1000 x 750 mm

- Peso: 50 kg (vazio)

1898/K40 5.300,00 1 018980004

ATENÇÃO:

Países onde é autorizada a distribuição do artigo 1898/K40: Áustria, Bélgica, França (a partir de 2021), Húngria, Itália, Países Baixos, Polónia, Portugal, Espanha, Reino Unido.

1898/B

bactérias, embalagem 300 ml, para tanque de
limpeza de componentes mecânicos 1898/K40



1898/B 109,00 1 018980904

ATENÇÃO:

Países onde o item 1898/B pode ser distribuído: Áustria, Bélgica, França, Itália, Holanda, Polónia, Portugal, Reino Unido, Espanha, Hungria

1898/D

detergente líquido ecológico, embalagem 20 l, para tanque de limpeza de componentes mecânicos 1898/K40



1898/D € 217,00 1 018980920

ATENÇÃO:

Países onde o item 1898/B pode ser distribuído: Áustria, Bélgica, França, Itália, Holanda, Polónia, Portugal, Reino Unido, Espanha, Hungria

1898/M

pulverizador com depósito 1,5 l

- bico ajustável com jato direto e pulverização de névoa
- escala graduada 0,5 l - 1 l - 1,5 l
- alavanca de bloqueio para jato contínuo
- não deve ser utilizado com hidrocarbonetos



H mm 340 l 1,5 € 17,60 1 018980930

1898/S

bomba hidráulica manual com depósito 5 l

- bico em aço inox
- alavanca de bloqueio para jato contínuo
- bico ajustável com jato direto e pulverização de névoa
- alça para facilitar o transporte
- punho ligação do bico
- tubo 1,2 m comprimento
- não deve ser utilizada com hidrocarbonetos



H mm 415 l 5 € 30,50 1 018980932



1899A

máquina de limpeza sistema DPF/FAP®

Podem ser usados detergentes especiais periodicamente para limpar e restaurar sistemas DPF e FAP® danificados por depósitos de fuligem e cinzas.



Inclui:

- 1 tubo de alimentação 2 m comprimento
 - 1 união rápida + bocal para mangueiras de sensor diferencial
 - 1 bocal de mangueira niplax M18x1,5 para ligação direta à sonda lambda
 - 1 extensão de mangueira
 - 1 bico de pulverização DPF/FAP®
 - 1 suporte de tubo magnético
 - 1 tubo com prensa-cabo de ajuste plus niplax M14/16/18 mm para ligação a sondas lambda
- Especificações técnicas:
- voltagem de funcionamento: 12 V
 - comprimento do cabo de alimentação: 3,9 m
 - capacidade do reservatório: 1 l

1899A € 1.450,00 1 018990010

1899SI

aparelho 2-em-1 para limpeza de injetores e de coletor de admissão

possibilidade de utilização de detergentes especiais para limpeza periódica dos injetores e do coletor de admissão em motores a diesel e gasolina, removendo depósitos de carbono e resíduos de combustão



Especificações:

- Voltagem: 12 V
- 2 tubos com uniões rápidas
- 2 depósitos (capacidade: 1l cada)

1899SI € 5.450,00 1 018990030

2080/VG

porta-ferramentas em ABS com compartimentos giratórios

- Com organizador superior para peças pequenas (145 mm de diâmetro) e 4 compartimentos giratórios:
- 1 compartimento com 305 mm de diâmetro
- 3 compartimentos com 445 mm de diâmetro
- Fornecido com 12 divisórias para utilização em 3 compartimentos giratórios maiores, para obter até 8 compartimentos por nível



2080/VG € 196,00 1 020800100
445x445x550 mm - 3,4 kg

2250-0

Banco giratório com tabuleiros, vazio



2250-0 € 126,00 1 022500011

2252

banco rolante



2252-G € 211,00 1 022520002

2252KR4

rodízios de substituição para banco 2252



2252KR4 € 71,00 1 022520900

2258N-O

banco com compartimento para ferramentas



2258N-O	€ 217,00	1	022580021
---------	----------	---	-----------

2258RR

rodízio de substituição para artigo 2258N



2258RR	€ 12,00	1	022580111
--------	---------	---	-----------

2254A

capa de proteção para veículos, para utilização ao ar livre, impermeável, com proteção contra raios UV

Ideais para proteger veículos danificados enquanto esperam para ser reparados

Características técnicas:

- acabamento exterior com proteção UV
- interior macio com acabamento anti-riscos
- 6 cordões para ajustar a capa ao veículo
- 2 fechos de correr junto às portas frontais para acesso ao veículo sem remover a capa
- espaço para espelho
- refletor



3 versões:

- tamanho M recomendado para veículos ligeiros compactos
- tamanho L recomendado para carrinhas
- tamanho XL recomendado para SUVs

	LxPxH mm	€	1	022540002
/M	4400x1450x1300	177,00	1	022540002
/L	5300x1450x1150	198,00	1	022540000
/X	4700x1450x1580	181,00	1	022540001

2254C

Proteção com ventosas para carroçarias

Em tecido com revestimento de borracha, com 4 ventosas na parte superior



2254C	L1 mm	L2 mm	€ 58,00	1	022540200
-------	----------	----------	---------	---	-----------

2254F

Proteção frontal para veículo

Proteção frontal do veículo, com aberturas para faróis e radiador.



- Impermeável
- Resistente ao óleo e massa
- Fixação de correias
- Material: 98% poliamida / nylon, 2% de poliuretano

2254F	€ 99,00	1	022540150
-------	---------	---	-----------

2254K

Protetores reutilizáveis de banco, volante e manete de mudanças

Adequado a bancos, volantes e manetes de mudanças da maioria dos carros



2254K	€ 34,00	1	022540101
-------	---------	---	-----------

2254SM

Esteira em espuma EVA

Duplo acabamento:

- 1 lado em espuma EVA suave
- 1 lado em carbono rígido para melhorar deslizamento



2254SM	€ 78,00	1	022540033
--------	---------	---	-----------

2254T

Esteira pequena

Em espuma EVA antiderrapante



2254T	€ 34,50	1	022540047
-------	---------	---	-----------

3000L

estrado

- Cobertura em PVC forrado com borracha acolchoada para um maior conforto.

Posição da cabeça ajustável em três posições

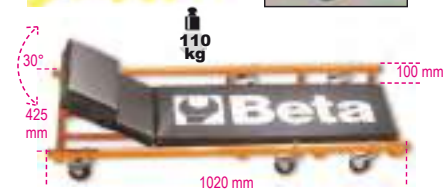

3000L	€ 200,00	1	030000210
-------	----------	---	-----------

3000L/RLS

rodízios de substituição para estrado



3000L/RLS	€ 14,50	6	030000212
-----------	---------	---	-----------

3002

esteira e banco

- Estrutura em aço
- Cobertura em PVC acolchoado
- Facilmente convertível em esteira ou banco

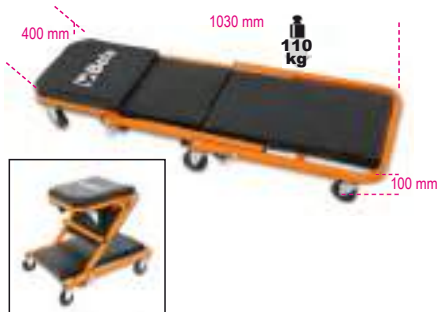

3002 € 133,00 1 030020001

3002/RLS

jogo de 6 rodas de substituição para esteira/banco 3002



3002/RLS € 34,50 1 030020501

3003

esteira em plástico anti-choque

- Ø das rodas: 76 mm



3003 € 104,00 1 030030001

3003/RLS

jogo de 6 rodas de substituição para esteira/banco 3003



3003/RLS € 53,50 1 030030501

Beta

3003C

Esteira em plástico à prova de embates

Completa com:

- acabamento tipo carbono nas zonas da cabeça e lombar**
- placas em metal na parte superior para fixar acessórios metálicos
- 6 rodízios em borracha, 79 mm de diâmetro
- Capacidade máxima: 120 kg
- Peso: 5.5 kg



3003C € 280,00 1 030030100

3003C/RLS

jogo de 6 rodas de substituição para esteira 3003C



3003C/RLS € 112,00 1 030030600

3003PRO

Esteira em plástico à prova de embates

Completa com:

- almofada ergonómica para cabeça
- protetor suave de costas
- rodízios com rolamentos duplos para utilização em superfícies irregulares
- 1 rodízio
- 2 medidas de ajuste de altura: 38 ou 76 mm
- 2 Lâmpadas LED portáteis (250 lumens) com fixação magnética
- Capacidade máxima: 200 kg
- Peso: 7.7 kg



C max	H min	H Max	H1	€	1	030030150
kg	mm	mm	mm			
200	170	230	230	392,00	1	030030150

3003PRO/SP

Suporte de parede para esteira 3003PRO

pode ser montado em paredes, sistemas de elevação, armários ou outros equipamentos, permitindo assim a fixação da esteira através de um sistema rápido com fecho de segurança.



3003PRO/SP € 105,00 1 030030151

3003PRO/PM

Suporte magnético para ferramentas, para esteira 3003PRO

pode ser aplicado nas jantes das rodas da esteira, para reter pequenas peças



3003PRO/PM € 11,30 1 030030152

3003PRO/RCR

rodas traseiras sobresselentes para esteira 3003PRO, par



3003PRO/RCR € 83,00 1 030030650

Beta

3003PRO/RRG

rodízio frontal sobresselente para esteira 3003PRO



3003PRO/RRG € 26,00 1 030030651

3003PRO/RT

lâmpada de inspeção LED com ímanes sobresselentes para esteira 3003PRO

- 250 lumens
- Pilhas 4xAAA (não incluídas)



3003PRO/RT € 18,90 1 030030652

3004

calço para rodas

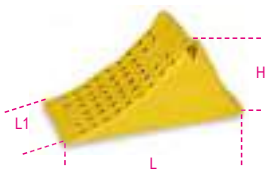

3004 H mm 225 L mm 475 L1 mm 200 € 42,50 1 030040000

REPARAÇÃO DE VEÍCULOS

As nossas ferramentas para reparação de veículos, usadas pelos profissionais mais exigentes, são desenvolvidas e fabricadas para cumprir as normas mais rígidas a nível mundial, e são testadas com regularidade sob as mais difíceis condições de trabalho.

Há mais de 50 anos que temos o orgulho de trabalhar de mãos dadas com os melhores, que nos ajudam a melhorar continuamente os nossos produtos e são testemunhas dos mais elevados padrões de qualidade.

As ferramentas de reparação de veículos encontram-se nas seguintes secções:

Diagnóstico
itens 1438 a 1499 itens 1758VT a 1760TMC
Motor
itens 955 a 989A itens 1438 a 1499
Óleo e filtros
itens 1438 a 1499 itens 1877 a 1885
Sistema elétrico
itens 1438 a 1499
Arranadores
itens 1498BC/12 a 1498/40A
Transmissão
itens 1438 a 1499
Suspensão
itens 1549 a 1569CP
Travões
itens 1438 a 1499
Rodas
itens 955 a 989A
Carroçaria
itens 1302 a 1369 itens 1763 a 1767A
Outros equipamentos
itens 1875LT a 3067
Elevação
itens 3029/2T a 3067/70-13T



3006

macaco para rodas de tratores e escavadoras

- capacidade máx.: 1,200 kg
- diâm. min. da roda: 1,000 mm
- diâm. máx. da roda: 2,200 mm
- espessura máx. da roda: 800 mm

CE



3006 € 2.100,00 1 030060000

3006 R/RGF

rodízio sobresselente com travão para macaco 3006



3006 R/RGF € 80,50 1 030060501

3006 R/RG

rodízio sobresselente para macaco 3006



3006 R/RG € 70,00 1 030060502

3007

trolley inferior para veículos sem rodas dianteiras / eixo traseiro

- Permite o fácil manuseamento de veículos sem rodas dianteiras ou eixo traseiro durante o trabalho
- 4 rodas giratórias, incluindo 2 com travão, adequadas para utilização em cabinas de pintura
 - 2 apoios móveis para adaptação a todos os chassis
 - capacidade máx.: 800 kg

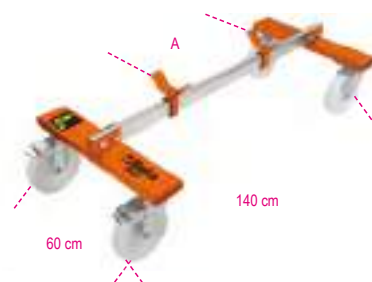

3007 A Max mm 110 € 755,00 1 030070001

Beta

3007 R/RGF

rodízio sobresselente com travão para trolley 3007



3007 R/RGF € 125,00 1 030070501

3007 R/RG

roda giratória sobressalente para trolley inferior 3007



3007 R/RG € 109,00 1 030070502

3008N

macaco e dispositivo de posicionamento para rodas simples e duplas em veículos pesados

- capacidade máxima: 500 kg
- altura mínima: 120 mm
- altura máxima: 650 mm
- distância entre rolos: 429+670 mm
- dispositivo de segurança contra sobrecarga hidráulica
- rodas frontais giratórias

CE



3008N € 3.560,00 1 030080110

3009

Elevador para rodas

Capacidade máxima de elevação: 550 kg
4 rodas de apoio
Largura das rodas: 200 mm
Para rodas até 240 mm de largura
Ideal para:

- carregar automóveis danificados para camiões de reboque
- oficinas de reparação de automóveis
- movimentação de veículos em salas de exposições



A 400=850 mm B 600 mm € 493,00 1 030090001

3009R/GR4

conjunto de 4 rodízios para elevador de rodas



3009R/GR4 € 202,00 1 030090501

3010/T...

preguiças, par



C max	H min	H Max	H1	L	L1
kg	mm	mm	mm	mm	mm
2000	280	425	245	185	165

3010T 2 € 117,00 1 030100002

C max	H min	H max	H1	L	L1
kg	mm	mm	mm	mm	mm
3000	285	430	250	180	195

3010T 3 € 138,00 1 030100003

C max	H min	H max	H1	L	L1
kg	mm	mm	mm	mm	mm
6000	400	580	340	245	280

3010T 6 € 201,00 1 030100006

C max	H min	H max	H1	L	L1
kg	mm	mm	mm	mm	mm
10000	471	735	420	330	290

3010T 10 € 345,00 1 030100010

3011/T

macacos de garrafa hidráulicos

CE



C max	H min	H Max	L
kg	mm	mm	mm
2000	174	369	90

3011T 2 € 104,00 1 030110020

C max	H min	H Max	L
kg	mm	mm	mm
3500	170	366	86

3011T 3,5 € 117,00 1 030110035

C max	H min	H Max	L
kg	mm	mm	mm
5000	203	467	118

3011T 5 € 131,00 1 030110050

C max	H min	H Max	L
kg	mm	mm	mm
10000	220	484	114

3011T 10 € 196,00 1 030110100

C max	H min	H Max	L
kg	mm	mm	mm
15000	230	497	113

3011T 15 € 239,00 1 030110150

C max	H min	H Max	L
kg	mm	mm	mm
20.000	245	521	115

3011T 20 € 343,00 1 030110200

3010H

preguiças para trabalhos pesados



C Max	H min	H Max	L	L1
kg	mm	mm	mm	mm
15,000	445	631	300	300

3010H631-T15 € 373,00 1 030100150

C Max	H min	H Max	L	L1
kg	mm	mm	mm	mm
15,000	645	1077	300	300

3010H1077-T15 € 468,00 1 030100165

3010V

preguiças para trabalhos pesados, regulação com parafuso



C Max	H min	H Max	L	L1
kg	mm	mm	mm	mm
20,000	410	600	330	330

3010V600-T20 € 545,00 1 030100200

C Max	H min	H max	L	L1
kg	mm	mm	mm	mm
20,000	665	1090	460	460

3010V1090-T20 € 690,00 1 030100220

3012

apoios para motor



L mm	C max kg	€		
1500	500	355,00	1	030120010
1800	400	481,00	1	030120018

3012C

suporte para motores

ideal para veículos ligeiros e comerciais

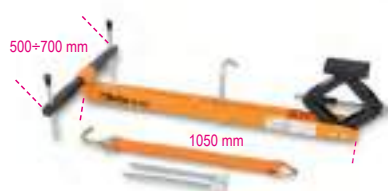

	€		
3012C	940,00	1	030120255

3012I

suporte inferior para motores

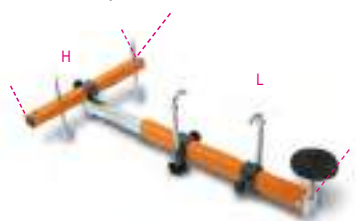

	L mm	H mm	€	
3012I	630+960	190	835,00	1 030120250

3014

suporte para motores



	€		
3014	447,00	1	030140010

3014R/GR5

jogo de 5 rodas de substituição para suporte motores 3014



	€		
3014R/GR5	112,00	1	030140501

3014 SAR

Suporte para motores

Capacidade máxima: 450 kg



	€		
3014SAR	1.640,00	1	030140360

3014SAR/RR

jogo de 4 rodas de substituição para suporte motores 3014SAR



	€		
3014SAR/RR	178,00	1	030140370

3014SAR/1

Reservatório colector de fluido



	€		
3014SAR/1	480,00	1	030140361
1020x1010x11 mm			

3014SAR/2

Grampo para fixação de caixas de velocidades no suporte ref. 3014 SAR

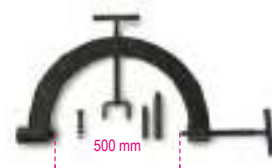

	€		
3014SAR/2	463,00	1	030140362

3023

macaco de fossas com parafuso de ajuste

capacidade máxima de carga: 400 kg



	H min-Max mm	Ø mm	€	
3023	1350+2030	300	247,00	1 030230050

3025N

grua hidráulica rebatível com bomba de duplo efeito

Especificações:

- capacidade máxima: 1 t
- 4 posições de carga: 300-600-800-1000 kg
- com válvula de limite de carga e suporte cromado
- velocidade de descida controlada
- rodas em nylon
- altura máxima: 2420 mm



A mm	B mm	C mm	D mm	€	
1560	1600	1000	880	2.530,00	1 030250110

3025N/PF

pinça para bidons

capacidade máxima: 300 kg

CE



	A mm	B mm	€	1	030250111
3025N/PF	550+640	70	555,00	1	030250111

3026 0,3

macaco de fossas hidráulico

CE



H min mm	H Max mm	L mm	L1 mm	Ø mm	€	1	030260003
1120	1970	450	450	25	805,00	1	030260003

3026/R0,3

jogo de 4 rodízios de substituição para macaco de fossas hidráulico 3026 0,3



3026/R 0,3	€	1	030260903
203,00	1	030260903	

3026 0,5

Macaco de fossas hidráulico, 500 kg

CE



H min mm	H Max mm	L mm	L1 mm	Ø mm	€	1	030260005
1140	1990	600	550	30	960,00	1	030260005

3026/R0,5

jogo de 4 rodízios de substituição para macaco de fossas hidráulico 3026 0,5



3026/R 0,5	€	1	030260905
283,00	1	030260905	

3026 1,0

macaco de fossas hidráulico

Capacidade máxima: 1 t

CE

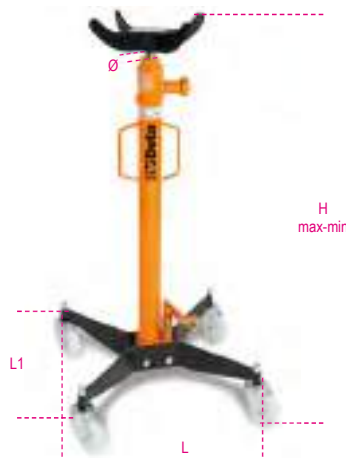

H min mm	H Max mm	L mm	L1 mm	Ø mm	€	1	030260010
1140	1990	650	550	35	1.160,00	1	030260010

3026/R 1,0

4 rodízios de substituição para macaco hidráulico item 3026 1,0



3026/R 1,0	€	1	030260910
365,00	1	030260910	

3026/S

suporte giratório para transmissões com casquilho de redução para macacos de fossas ref. 3026

Capacidade máxima: 500 kg

CE



3026/S	€	1	030260501
685,00	1	030260501	

3026/SP

suporte de transmissão universal

permite a montagem e desmontagem de quaisquer transmissões por apenas um operador em veículos ligeiros, comerciais e todo-o-terreno de forma rápida e segura.

CE



3026/SP	€	1	030260505
795,00	1	030260505	

3026/SA

Suporte para rolamentos de rodas para macacos de fossas

- para trabalhos de manutenção em rolamentos ou substituição de amortecedores
- pode ser adaptado aos macacos de fossas hidráulicos 3026 0,3 e 3026 0,5

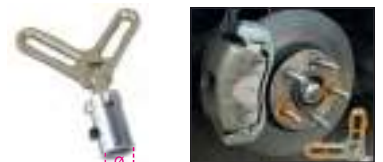

3026/SA	Ø mm	€	1	030260510
166,00	30,4	1	030260510	

3026/SAM

Suporte para amortecedores para macacos de fossas

- para apoiar amortecedor quando o braço de suspensão é removido
- suporte de amortecedor, diâmetro máximo 80 mm, mais adaptador para diâmetros máximos de 60 mm
- pode ser adaptado aos macacos de fossas hidráulicos 3026 0,3 e 3026 0,5



3026/SAM	€	1	030260515
214,00	1	030260515	

3027N 10

prensa hidráulica de bancada com pistão

- capacidade máxima: 10 t
- bomba manual de 2 velocidades
- movimento por pistão
- retorno automático do pistão
- inclui jogo de prismas em V
- suporte cromado

CE



3027N 10 € 2.230,00 1 030270101

3027N 20

prensa hidráulica com pistão

- capacidade máxima: 20 t
- bomba manual de 2 velocidades
- movimento por pistão
- suporte cromado
- retorno automático do pistão
- dispositivo de segurança contra sobrecarga hidráulica
- manómetro
- inclui jogo de prismas em V

CE



3027N 20 € 3.090,00 1 030270102

3027N 30

prensa hidráulica com pistão e diferencial

- capacidade máxima: 30 t
- bomba manual de 2 velocidades
- movimento por pistão
- suporte cromado
- retorno automático do pistão
- dispositivo de segurança contra sobrecarga hidráulica
- manómetro
- diferencial de cabo de aço para elevação

CE



3027N 30 € 5.400,00 1 030270103

3027N 50

prensa hidráulica com pistão e diferencial

- capacidade máxima: 50 t
- bomba manual de 2 velocidades
- movimento por pistão
- suporte cromado
- retorno automático do pistão
- dispositivo de segurança contra sobrecarga hidráulica
- manómetro
- inclui jogo de prismas em V
- diferencial de cabo de aço para elevação

CE



3027N 50 € 7.550,00 1 030270105

3027N 100

prensa eletro-hidráulica motorizada com pistão e diferencial

- capacidade máxima: 100 t
- motor trifásico: 230-400 V
- frequência: 50 Hz
- potência do motor elétrico: 3 kW
- bomba eletro-hidráulica de duas velocidades
- operado por alavanca de três posições: alimentação-neutro-retorno
- movimento por pistão
- pistão Ø: 100 mm
- diferencial de cabo de aço para elevação
- cabo de alimentação com ficha industrial de 4 polos (380V)
- inclui óleo do motor

CE



3027N 100 € 23.200,00 1 030270110

3027N/KP

jogo de punções e placa para prensa 3027N



		€		
3027N/KP10-20	3027N10-20	414,00	1	030270511
3027N/KP30	3027N 30	580,00	1	030270531
3027N/KP50	3027N 50	710,00	1	030270541
3027N/KP100	3027N 100	1.300,00	1	030270552

3027N/KPP

pedal para prensas hidráulicas 3027N



		€		
3027N/KPP10		442,00	1	030270560
3027N/KPP50		505,00	1	030270565



3027/PR

Ferramenta de suporte para montar/desmontar cubos das rodas, rolamentos e sinoblocos

Sistema universal que permite ao utilizador montar/desmontar cubos das rodas, rolamentos e sinoblocos através de uma prensa com uma base de suporte.

A ferramenta adapta-se a formas geométricas irregulares de cubos das rodas, pinos...



Características técnicas

Amplitude de trabalho: min. 130mm - máx. 186mm

Dimensões: 300x300mm

Peso: 13kg

Capacidade de carga máx.: 20 t

3027/PR € 730,00 1 030270400

3028 15

prensa hidráulica de bancada com pistão

capacidade máxima: 15 t

regulação manual da altura

movimento por pistão



A mm 1010 B mm 565 C mm 480 D mm 80+370 € 1.220,00 1 030280015

3028SP/15

resguardo de proteção para prensa 3028 15



3028SP/15 € 177,00 1 030280016

3028 20

prensa hidráulica com pistão móvel

capacidade máxima: 20 t

regulação vertical da parte superior

pistão deslizante

CE

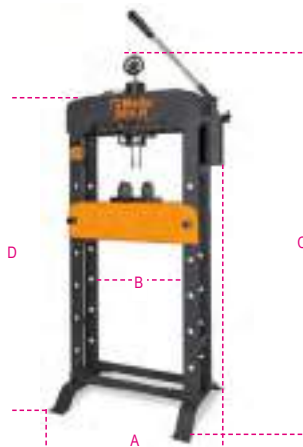

A mm 850 B mm 540 C mm 1830 D mm 1602 € 1.770,00 1 030280020

3028SP/20

capa de proteção para prensas 3028 20



3028SP/20 € 197,00 1 030280021

3028 30

prensa hidráulica com pistão móvel

capacidade máxima: 30 t

regulação vertical da parte superior

pistão deslizante

CE

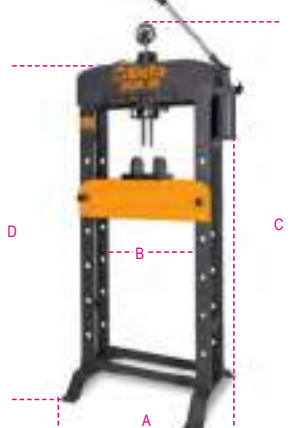

A mm 850 B mm 540 C mm 1850 D mm 1650 € 2.460,00 1 030280030

3028SP/30

capa de proteção para prensas 3028 30



3028SP/30 € 197,00 1 030280031

3028 50

prensa hidráulica com pistão móvel e guincho

capacidade máxima: 50 t

regulação vertical da parte superior através de guincho

pistão deslizante

CE

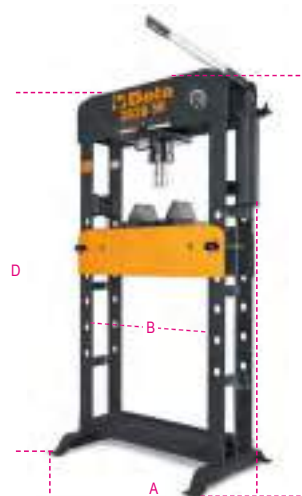

A mm 1100 B mm 750 C mm 1850 E mm 820 € 4.300,00 1 030280050

3028SP/50

capa de proteção para prensas 3028 50



3028SP/50 € 209,00 1 030280051

3028/KP

kit de punções e placa para prensas 3028



3028/KP € 153,00 1 030280055



3029/2T

Macaco hidráulico rebaixado, 2t com 4 rodas

- Pedal de aproximação
- Estrutura em aço e rodas em nylon
- Altura mínima: 75mm

CE



3029/2T € 490,00 1 030290020

3029L/2T

Macaco hidráulico rebaixado, longo, 2t

Permite trabalhar em veículos com altura reduzida e ponto de elevação recuado

- Controle da velocidade de descida
- Pedal de aproximação
- Rodas em nylon

CE

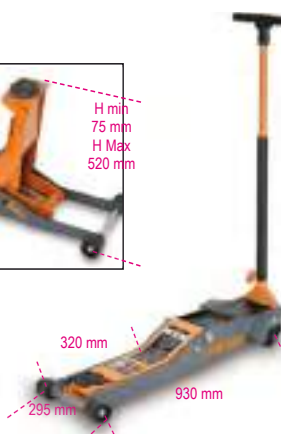

3029L/2T € 570,00 1 030290120

3029/2T-L/RP

placa de borracha de substituição 85-mm para itens 3029/2T e 3029L/2T



3029/2T-L/RP € 19,20 1 030290502

3029/2T-L/R6

roda traseira de substituição para itens 3029/2T, 3029L/2T, 3030H/2T, 3033E/3T



3029/2T-L/R6 € 62,50 1 030290506

3029/2T-L/R5

roda frontal de substituição para macacos item 3029/2T e item 3029L/2T



3029/2T-L/R5 € 58,00 1 030290505

3030/2T

macaco hidráulico, 2 t com 6 rodas

- Duas rodas frontais giratórias em plástico (PTFE)
- Macaco hidráulico facilmente manobrável em superfícies irregulares
- Capacidade máxima: 2 toneladas

CE



3030/2T € 935,00 1 030300020

43 kg

3030/2T-R5

roda dianteira de substituição para macaco hidráulico 3030 2T



3030 2T/R5 € 32,50 1 030300505

3030/2T-R6

roda traseira de substituição para artigo 3030/2T



3030 2T/R6 € 51,00 1 030300506

3030/2TRP

prato de borracha 85 mm sobresselente para ref. 3030/2T



3030/2TRP € 6,60 5 030300501

3030H/2T

macaco hidráulico de grande elevação, 2 t, com 6 rodas

possibilita o trabalho em veículos elevados do chão e com um curso longo do amortecedor

- velocidade de descida controlada
- pedal de aproximação rápida
- rodas em nylon

CE



H min-Max mm 85-780 L mm 1010 L1 mm 300 € 780,00 1 030300220

3033/3T

macaco hidráulico, 3t versão longa

- Para utilização em veículos comerciais
- Capacidade máxima: 3 t
- Rodas em poliamida

CE



3033/3T € 1.240,00 1 030330030

Beta

3033E/3T

macaco hidráulico,

3 t

- velocidade de descida controlada
- rodas em nylon

CE



	H	L	L1	€		
	min-Max	mm	mm			
3033E/3T	95-515	700	370	457,00	1	030330130

3033S 3T/R2

roda frontal de substituição
para macaco 3033E/3T



3033S 3T/R2	€ 52,50	1	030330532
-------------	---------	---	-----------

Beta

3035

carro para movimentação de pneus

- Para transporte fácil de pneus até 980 mm de diâmetro
- A estrutura robusta permite a movimentação de pneus sem ter de suportar o peso fisicamente
- Pode ser utilizado para posicionamento da roda
- 2 rodas Ø 260 mm
- 2 rodas Ø 125 mm
- Altura máx. de carga: 1.60 m
- Peso máx. de carga: 200 kg
- Garfos ajustáveis em 2 posições:
primeira posição: abertura máxima 880 mm
segunda posição: abertura máxima 980 mm



3035	€ 1.130,00	1	030350100
------	------------	---	-----------

3036

base para movimentação de pneus

Rodas anti-marca em borracha



3036	€ 133,00	1	030360063
------	----------	---	-----------

3061/2T

macaco hidráulico, 2 ton - 2 estádios

CE



Equipado com:

- diafragma três camadas de alta resistência e guia telescópica interna
- batente fim de curso e válvula de segurança contra sobrecarga
- pode ser utilizado com elevadores de garagem

CARACTERÍSTICAS TÉCNICAS

capacidade: 2 t
 peso: 14 kg
 pressão de trabalho: 8-10 bar
 altura: min.132 - max. 326 mm

3061/2T	€ 1.050,00	1	030610020
---------	------------	---	-----------

3061/2T-P50

extensão 50 mm para artigo 3061/2T



3061/2T P50	€ 89,00	1	030610021
-------------	---------	---	-----------

3061/2T-P100

extensão 100 mm para artigo 3061/2T



3061/2T P100	€ 119,00	1	030610022
--------------	----------	---	-----------

Beta

Beta

3065/20-10T

macaco hidráulico, 20-10 t, com mala

Portátil e leve, ideal para operações de assistência no exterior



• Fornecido com duas extensões, 75 e 60 mm de comprimento

CARACTERÍSTICAS TÉCNICAS

capacidade: 20-10 t

peso: 23 kg

pressão: 8-10 bar

consumo de ar: 400 nl/min

3065/20-10T 3.090,00 € 1 030650100

3065/40-20T

macaco hidráulico, 40/20 toneladas



- adequado para veículos pesados
- funcional e de fácil manuseamento, também para transporte em oficinas móveis
- retorno automático do pistão
- duas válvulas de descida com comando da velocidade sob carga

CARACTERÍSTICAS TÉCNICAS

capacidade: 40/20 tons

peso: 39 kg

pressão de trabalho: 8-10 bar

consumo de ar: 400 l/min

3065/40-20T 3.470,00 € 1 030650200

3067/60-15T

macaco pneumático, 60-30-15 t

Com uma altura mínima de 120 mm, é particularmente adequado para utilização em veículos pesados de passageiros



- Retorno automático do pistão
- Duas válvulas de descida com control da velocidade sob carga
- Fornecido com duas extensões, 70 e 120 mm de comprimento

CARACTERÍSTICAS TÉCNICAS

capacidade: 60-30-15 t

peso: 56 kg

pressão: 8-10 bar

consumo de ar: 600 l/min

3067/60-15T 5.150,00 € 1 030670120

3067/70-13T

macaco hidráulico, 70-43-23-13 t



- Versão longa, adequada para utilização em veículos pesados, articulados, pesados de passageiros e máquinas agrícolas
- retorno automático do pistão
 - duas válvulas de descida com controlo da velocidade sob carga

CARACTERÍSTICAS TÉCNICAS

capacidade: 70-43-23-13 tons

peso: 74 kg

pressão de trabalho: 8-10 bar

consumo de ar: 600 l/min

3067/70-13T 6.450,00 € 1 030670130

3068

porta-paletes manual com braços rebaixados



Características técnicas:

- capacidade máxima: 2500 kg
- comprimento total: 1200 mm
- comprimento dos braços: 800 mm
- largura dos braços: 540 mm
- largura individual do braço: 160 mm
- altura da alavanca: 1230 mm
- altura máx. de elevação: 115 mm

3068 920,00 € 1 030680000

3069

porta-paletes manual



Características técnicas:

- capacidade máxima: 2.500 kg
- comprimento total: 1550 mm
- comprimento dos braços: 1150 mm
- largura do braços: 540 mm
- largura individual do braço: 160 mm
- altura da alavanca: 1230 mm
- altura máx. de elevação: 115 mm
- área de armazenamento de paletes: 800x1200 longitudinalmente: 1805 mm
- raio de viragem: 1347 mm

3069 865,00 € 1 030690000



FERRAMENTAS PARA MOTOCICLOS

A gama de ferramentas para motociclos da Beta inclui produtos concebidos especificamente para a indústria de motociclos. Os nossos produtos são atualizados regularmente.



3040C

apoio traseiro para motociclos,
regulável

- Lacado preto mate
- 4 rodas em borracha termoplástica
- Inclui rolamentos em V, par
- Inclui rolamentos em L em borracha, par



3040C € 92,50 1 030400002

3040C/S1

rolamentos em V, par,
para item 3040C



3040C/S1 € 14,70 1 030400503

3040C/S2

rolamentos em L em borracha, par,
para item 3040C



3040C/S2 € 21,20 1 030400504

3041C

apoio frontal para motociclos,
regulável

- Lacado preto mate
- 4 rodas em borracha termoplástica
- Inclui rolamentos, par
- Inclui rolamentos cónicos, par



3041C € 86,50 1 030410002

3041C/12

rolamentos, par,
para item 3041C



3041C/12 € 20,40 1 030410512

3041C/16

rolamentos cónicos,
para item 3041C



3041C/16	€ 14,00	1	030410516
----------	---------	---	-----------

3042C

apoio frontal
para pino de direção de motocicletas

- Lacado preto mate
- 4 rodas em borracha termoplástica
- Inclui jogo de 8 pinos Ø 13 - 15 - 15.5 - 17 - 19 - 20 - 21 - 27



3042C	€ 156,00	1	030420002
-------	----------	---	-----------

3043C

apoio para motocicletas
com braço à esquerda

- Lacado preto mate
- 4 rodas em borracha termoplástica



3043C	€ 114,00	1	030430002
-------	----------	---	-----------

3043C/ 41÷47

pino
para ref. 3043C



	Ø mm	€		
3043C/41 Ducati	21,5 ÷ 25,5	26,00	1	030430551
3043C/42 KTM - Triumph	27,5	26,00	1	030430552
3043C/43 MV	42,5	28,50	1	030430553
3043C/44 Ducati	40,5	28,50	1	030430554
3043C/45 Honda	28,5	26,00	1	030430555
3043C/47 BMW	53,5	33,50	1	030430557

3047C

cavelete manual para motocicletas cross/enduro



3047C	€ 72,00	1	030470002
-------	---------	---	-----------

3048C

preguiça em alumínio



3048C	€ 72,00	1	030480002
-------	---------	---	-----------

3050/CC

Elevador manual para motocicletas Custom,
Enduro, Cross, Scooter



inclui kit de suporte ajustável

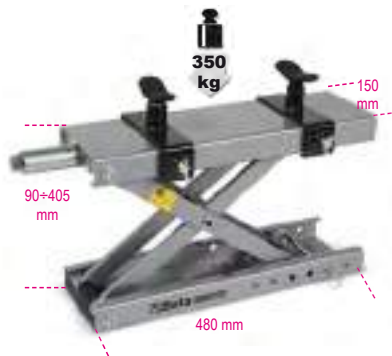

3050/CC	€ 185,00	1	030500012
---------	----------	---	-----------

3050/600

elevador para motocicletas electro-hidráulico,
600 kg

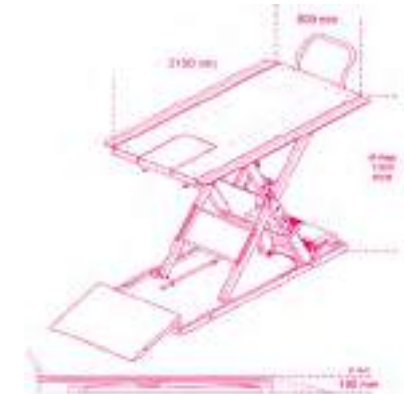
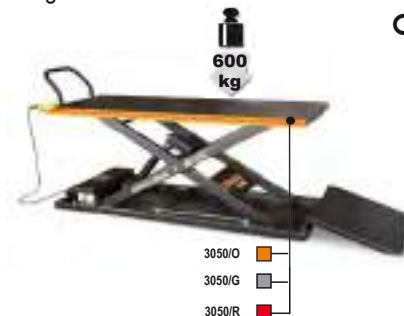

Características técnicas

- Dispositivos de segurança elétricos, mecânicos e hidráulicos
- Capacidade: 600 kg
- Unidade electro-hidráulica integrada: 230V - 50 Hz
- Bomba hidráulica
- Velocidade de descida controlada
- Fusíveis de segurança para proteção em caso de corte dos cabos
- Painel de controlo com botão
- Certificado CE, aprovação TÜV

	L mm	L mm	H min mm	H Max mm	€		
3050/O	975	2100	185	1110	6.250,00	1	030500201
3050/G	975	2100	185	1110	6.250,00	1	030500202
3050/R	975	2100	185	1110	6.250,00	1	030500203

3050/KA

kit de extensão para elevador item 3050/600



	A mm	B mm	€		
3050/KA-O	107,5	2100	1.250,00	1	030500221
3050/KA-G	107,5	2100	1.250,00	1	030500222
3050/KA-R	107,5	2100	1.250,00	1	030500223

3050/MS

bloqueio de roda para item 3050/600



permite o bloqueio da roda frontal do motociclo



3050/MS	€ 710,00	1	030500032
---------	----------	---	-----------



3050/MV

grampo de rodas mecânico para elevador
3050/600



3050/MV € 1.240,00 1 030500034

3050/LA

tampo de metal para item 3050/600

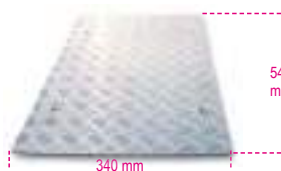

3050/LA € 142,00 1 030500062

9562T1

tapete para oficina, 100X80 cm

particularmente adequado para utilização com BETA 3071 e 3071B

• borracha antiderrapante de limpeza fácil



9562T1 L cm 100 H cm 80 € 91,00 1 095620150

9562T3

tapete para oficina

Dimensões: 300x160 cm

- particularmente adequado para utilização sob motocicletas
- protege o chão de derrames de óleo e combustível, respeita o meio ambiente
- limpeza fácil, parte de trás antiderrapante em borracha

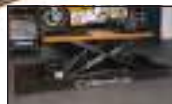

9562T3 L cm 300 H cm 160 € 360,00 1 095620300

3054

trolley para suporte central ou apoio traseiro de motocicletas
com extensão para apoio lateral



3054 max kg 500 € 312,00 1 030540000

3055M

Bloqueio automático de motocicletas para carrinhas

Permite fixar a roda dianteira do motociclo



3055M € 119,00 1 030550002

3057

rampa em alumínio para carga/descarga de motocicletas



3057 € 253,00 1 030570001

3070B

Equilibrador manual



. Permite equilibrar as rodas tanto nas oficinas como nas pistas de corrida;
. Equipado com rolamentos nivel de bolha de nivelção e pesos ajustáveis para uma precisão exata;
. Vem com 2 cones para cubos;

3070B € 149,00 1 030700100

3070B/...

apoio para equilibrador 3070B



3070B/10 Ø1 30 Ø2 10 L 410 € 26,50 1 030700101
3070B/12 30 12 415 31,00 1 030700102
3070B/14 40 14 415 38,00 1 030700103

3070BE/K

Equilibrador de rodas manual eletrónico, portátil

Equilibrador manual com microprocessador (sem motor) para equilibrar rodas de aço ou liga leve de automóveis e motocicletas.



- compacto e fácil de transportar, para utilização em oficinas, camiões e pistas de corridas
- pode ser montado numa bancada de trabalho ou numa parede
- o software inclui todos os programas de correção de desequilíbrio, leitura das posições com pesos adesivos (ALUS), pesos escondidos atrás dos raios (SPLIT) e otimização do equilíbrio
- pode ser utilizado com suporte giratório Beta 3070BE/S (opcional)

ACESSÓRIOS:

- régua graduada flexível
- porca com manivela e 3 cones Ø 45 x 110 mm

DADOS TÉCNICOS

Corrente: 115-230V AC ou 12-24V DC

Potência nominal: 0.15 kW

Rotação: 100 rpm

Margem de erro: 1 g

Largura roda: 1.5" + 20" (40 + 510 mm)

Peso máximo da roda: max. 75 kg

3070BE/K € 3.730,00 1 030700250

3070BE/S

Suporte giratório para equilibrador manual eletrónico portátil 3070BE

Permite que o equilibrador seja fixado na parede ou numa bancada de trabalho, pelo que requer um reduzido espaço de instalação



3070BE/S L mm 514 L1 mm 280 € 1.370,00 1 030700201

3070BE/F

Flange universal para rodas de motocicletas, Ø 40 mm,
para equilibrador de rodas 3070BE
Para utilização em rodas com furo central Ø 15 + 35 mm, e
jantes com calço até Ø 68 mm



3070BE/F	€ 1.860,00	1	030700202
----------	------------	---	-----------

3070BE/B

kit 8 chaves para rodas de motocicletas,
para o item 3070BE

indicadas para os seguintes diâmetros:
28 - 25 - 22 - 20 - 19.05 - 17 - 16 - 15



3070BE/B	€ 2.080,00	1	030700203
----------	------------	---	-----------

3071A

alavanca desmontagem manual de pneus de
motociclos cross e enduro

Permite a remoção fácil e rápida de pneus em pistas de
corrida; estrutura ampla e robusta em aço galvanizado,
proporciona firmeza na desmontagem do pneu. Pode ser
instalada no apoio BETA 3071RS, para maior conveniência

- Características:
- Punho ergonômico em borracha, para segurar a alavanca de forma fácil e segura
 - Retentor de borracha com haste para bloqueio durante o transporte
 - Pode ser utilizada para instalar pneus cross e enduro, 17" + 21".



3071A	L mm 570	H mm 400	P mm 850	Ø mm 440	€ 575,00	1	030710000
-------	----------	----------	----------	----------	----------	---	-----------

3071B

alavanca desmontagem manual de pneus de
motociclos mini bikes e mini dirt bikes

Permite a remoção fácil e rápida de pneus em pistas de
corrida; estrutura ampla e robusta em aço galvanizado,
proporciona firmeza na desmontagem do pneu. Pode ser
instalada no apoio BETA 3071RS, para maior conveniência

Características:

- Punho ergonômico em borracha, para segurar a alavanca de forma fácil e segura
- pode ser utilizada para instalar pneus mini bike e mini dirty bike.



3071B	L mm 570	H mm 330	P mm 650	Ø mm 340	€ 540,00	1	030710010
-------	----------	----------	----------	----------	----------	---	-----------

3071RS

apoio para BETA 3071A e alavanca de
desmontagem 3071B

Utilizado para elevar as alavancas de desmontagem BETA
3071A e 3071B, facilitando a remoção do pneu; estrutura em
aço galvanizado, base quadrada para maior firmeza.

- Com 4 ganchos de fixação

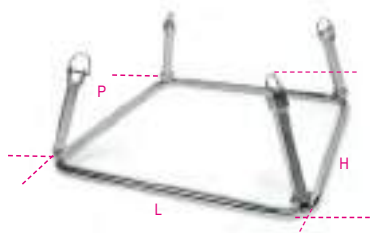

3071RS	L mm 670	H mm 275	P mm 670	€ 250,00	1	030710020
--------	----------	----------	----------	----------	---	-----------

962C

ferros de desmonta, par,
para motociclos cross e enduro, mini bikes e
mini dirty bikes
para utilização em combinação com BETA 3071A e 3071B



962C	L mm 420	A mm 30	€ 132,00	1	009620020
------	----------	---------	----------	---	-----------

3072N

bancada de trabalho para desmontagem
manual do amortecedor traseiro de motocicletas

Permite a desmontagem do amortecedor traseiro de
motociclos de forma totalmente segura; através dos braços
ajustáveis, é adequada para a maioria dos amortecedores
traseiros; em alternativa, pode ser utilizado com a placa
fornecida.

- anéis de bloqueio opcionais

- Características
- Adequada para utilização na maioria dos amortecedores traseiros de motocicletas
 - Ajuste vertical em 8 posições
 - 3 braços ajustáveis com retentores com ajuste vertical
 - Placa de bloqueio do amortecedor
 - Macaco pantógrafo
 - Pés de borracha
 - Pino de bloqueio do amortecedor

Características técnicas:

- Extensão do macaco: máx. 130 mm
- Extensão do braço: máx. 55 mm
- Extensão do retentor: máx. 18 mm
- Impulso: máx. 1 t



3072N	L mm 390	H mm 785	P mm 390	€ 1.300,00	1	030720010
-------	----------	----------	----------	------------	---	-----------

3073

ferramenta universal para substituição dos
O-rings de suspensão
para tubos de diâmetro 35 + 48 mm

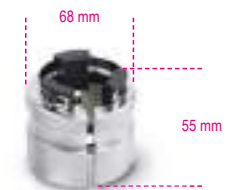

3073	€ 99,00	1	030730001
------	---------	---	-----------

30740

chave para suspensão eletrônica Ohlins

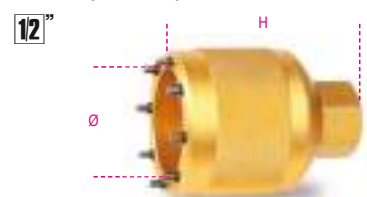

30740	H mm 70,5	Ø mm 50,5	€ 116,00	1	030740001
-------	-----------	-----------	----------	---	-----------

30740/S

chave para suspensão Sachs para DUCATI Multistrada

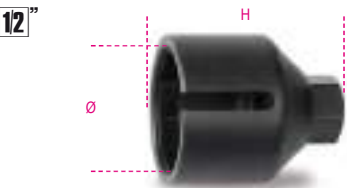

30740/S	H mm	Ø mm	€	1	030740002
	75	65	131,00		

30740/M

chave para suspensão Marzocchi para DUCATI 1199 e Hypermotard

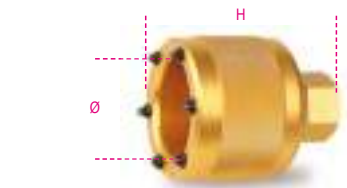

30740/M	H mm	Ø mm	€	1	030740003
	69	55	114,00		

30740/2

chave para suspensão octogonal Ohlins para motos DUCATI



30740/2	H mm	Ø mm	€	1	030740004
	45	65	120,00		

3075A

chave sextavada para eixo da roda



3075A 28	Ø mm	Ø mm	L mm	€	1	030750028
	28	38	30	32,00		
3075A 30	Ø mm	Ø mm	L mm	€	1	030750030
	30	40	30	34,50		

3075B

chave bi-sextavada para eixo de roda

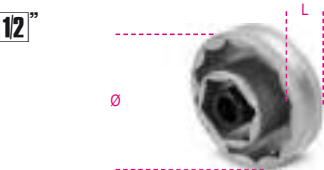

3075B 55	Ø mm	Ø mm	L mm	€	1	030750155
	55	70,7	25	82,50		

3075MV

Chave Bi-Sextavada para eixo de roda



3075MV 56	Ø mm	Ø mm	L mm	€	1	030750156
	56	70,7	30	92,50		

3075/CM

chave sextavada múltipla para eixo da roda



3075/CM	€	1	030750212
12-14-17-19-22-24 mm	46,50		

3075/K10

kit com chave universal com cabeça intercambiável e 10 bits, para jantes

Tamanhos: 5.2 - 5.4 - 5.6 - 5.8 - 6.0 - 6.2 - 6.4 - 6.6 - 6.8 - 7.0



3075/K10	€	1	030750410
	62,00		

3079/21

lubrificador de cabos

Permite a lubrificação adequada dos cabos da embraiagem e do controlo de gás, para aumentar a suavidade do revestimento e duração do cabo.



3079/21	€	1	030790021
	9,40		

3080/C15

Kit abertura e cravagem de correntes

Ø 3-4-5 mm e kit Regina



3080/C15	€	1	030800015
	411,00		

420x185x60 mm

3080R/CS3

kit com 3 punhos de substituição para corrente 3080 / C15

Ø 3-4-5 mm



3080R/CS3	€	1	030800503
	63,50		

3081

ferramenta para cravar

Robusta e articulada, facilmente transportável. Adequada para correntes 415, 420, 428, 520, 525, 530, 532



3081	€	1	030810010
	51,50		

3085

ferramenta para recuar êmbolos dos travões

Adequada para motocicletas e scooters



3085	€	1	030850010
	114,00		

3091

extrator de rosca interna para volante magnético



	M	€		
3091/10	24x1,5	23,90	1	030910010
3091/20	26x1,0	25,00	1	030910020
3091/25	27x1,0	25,50	1	030910025
3091/30	28x1,0	25,50	1	030910030
3091/40	30x1,0	34,00	1	030910040
3091/45	30x1,5	34,00	1	030910045
3091/50	32x1,5	37,00	1	030910050
3091/60	33x1,5	38,50	1	030910060
3091/70	35x1,0	54,50	1	030910070
3091/75	35x1,5	54,50	1	030910075
3091/80	38x1,5	59,50	1	030910080

3092

extrator de rosca externa para volante magnético



	M	€		
3092/10	18x1,5	12,70	1	030920010
3092/20	19x1,0	14,80	1	030920020
3092/25	27x1,0	15,40	1	030920025
3092/30	27x1,25/20x1	15,50	1	030920030
3092/35	22-26x1,5	15,50	1	030920035
3092/40	25x1,5/22x1	15,50	1	030920040
3092/50	26-28x1,0	15,50	1	030920050
3092/60	28x1,5	15,30	1	030920060

3093/E

ferramentas de bloqueio para prato de embraiagem, volante magnético e polias



	€		
3093/E	42,00	1	030930100

3093/U

extrator múltiplo para volante magnético



	€		
3093/U	40,50	1	030930050
M10x1.25R			
M14x1.5R			
M16x1.5R			
M18x1.5R			
M24x1.0R			
M27x1.0L			

3094PA

apoio para motocicletas OFFROAD

Estrutura de metal; pernas rebatíveis na estrutura; recomendado para organização de ferramentas em pistas de corridas

disponível em 3 cores:

- 3094PA-O Laranja
- 3094PA-G Cinza
- 3094PA-R Vermelho

Acessórios opcionais:

- Porta-rolos de papel 3200 PR
- Porta-garrafas magnético universal 2499PF/M

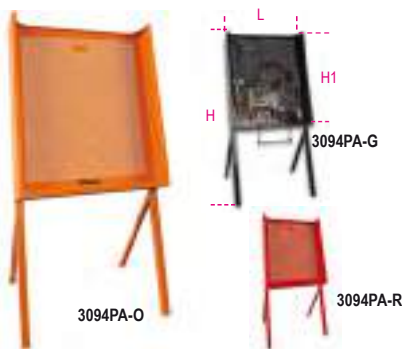

	L	H	H1	€		
	mm	mm	mm			
3094PA-O	750	1555	900	600,00	1	030940101
3094PA-G	750	1555	900	600,00	1	030940102
3094PA-R	750	1555	900	600,00	1	030940103

3095

apoio de bancada para motores de motocicletas

suportes de montagem ajustáveis, para um trabalho conveniente e sem esforço em motores de motocicletas



	H	P	L	L1	€		
	mm	mm	mm	mm			
3095	360	460	640	460	675,00	1	030950001

3099E

revestimento de exterior para motocicletas, impermeável (água e poeiras)

proteção da pintura contra riscos, poeiras e luz solar



Tamanho "M" recomendado para motocicletas desportivas e scooters de tamanho médio
Tamanho "L" recomendado para motocicletas maxi enduro e crossover

		€		
3099E/M	M	95,50	1	030990102
3099E/L	L	118,00	1	030990103

3099T

revestimento de interior para motocicletas, em tecido extensível

proteção da pintura contra riscos, poeiras e luz solar



Tamanho "M" recomendado para motocicletas desportivas e scooters de tamanho médio

Tamanho "L" recomendado para motocicletas maxi enduro e crossover

Tamanho "XL" motocicletas super touring

		€		
3099T/M	M	83,00	1	030990202
3099T/L	L	102,00	1	030990203
3099T/XL	XL	123,00	1	030990204





FERRAMENTAS PARA BICICLETAS

Beta sempre esteve envolvida com o ciclismo. Este “Especial Ferramentas para Bicletas”, destinado aos profissionais do ciclismo, inclui uma seleção de produtos especialmente desenvolvidos para manutenção de bicicletas e e-bikes.



Tour de France 2020 and 2021



Partnership 2023

*Official contributor
of Eolo KOMETA cycling*



Partnership 2023



3910

elevador E-Bike



- Capacidade de carga máx.: 40 kg
- Altura máx. do suporte de movimento central: 135 cm
- Base de rodas integrada
- Inovador sistema de bloqueio do eixo
- Fornecido com adaptadores para a maioria dos garfos
- Fornecido com adaptador de garfo sem eixo
- Totalmente dobrável e de fácil transporte
- Peso: 48kg

CE

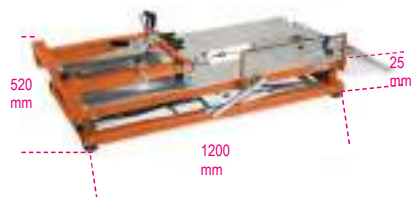

3910 € 4.110,00 1 039100010

3912TP

bancada de trabalho TOP para manutenção de bicicletas



- Com suporte para movimentação central, com pino de segurança
- Gaveta de ferramentas com guias de rolamentos de esfera (490x365x90 mm)
- Suporte para roda incorporado
- Sistema inovador de bloqueio através do eixo



3912TP € 1.710,00 1 039120050

3912PP

bancada de trabalho PRO para manutenção de bicicletas



- Com suporte para movimentação central, com pino de segurança
- Suporte para roda incorporado
- Sistema inovador de bloqueio através do eixo



3912PP € 930,00 1 039120150

3912TP/A

adaptador para garfos com eixo passante



Para bancadas de trabalho 3912TP, 3912PP e 3910



L mm 39 Ø mm 30 Ø1 mm 5 € 22,70 1 039120052

3912TP/C

adaptador universal para garfos com eixo passante, aperto com chave de caixa sextavada



Para bancadas de trabalho 3912TP, 3912PP e 3910



L mm 29 Ø mm 30 € 22,70 1 039120054

3912TP/FOX

adaptador para garfos FOX®



Para bancadas de trabalho 3912TP, 3912PP e 3910



L mm 38 € 22,70 1 039120058

3912TP/QRE

pino adaptador para garfos sem eixo passante



Para bancadas de trabalho 3912TP, 3912PP e 3910



L mm 108 € 37,50 1 039120064

3912TP/ROAD

adaptador para garfos de estrada



Para bancadas de trabalho 3912TP, 3912PP e 3910



L mm 33 Ø mm 35 € 25,50 1 039120060

3912TP/RS

adaptador para garfos com eixo passante ROCKSHOX®



Para bancadas de trabalho 3912TP, 3912PP e 3910



L mm 35 Ø mm 30 € 22,70 1 039120056

3912TP/ST

adaptador para garfos SUNTOUR



Para bancadas de trabalho 3912TP, 3912PP e 3910



L mm 31 Ø mm 30 Ø1 mm 18 € 25,50 1 039120062



3916MMP

grampo unilateral para reparação de bicicletas

- Rotação 360°
- Capacidade de carga: 25 kg
- Tabuleiro em plástico



3916MMP € 840,00 1 039160150

3918MML

grampo unilateral, leve, dobrável

- Grampo rotativo a 360°
- Capacidade: 15 kg
- Altura máx. do grampo: 150 cm



3918MML € 342,00 1 039180010

3921

Calibrador do suporte de mudanças

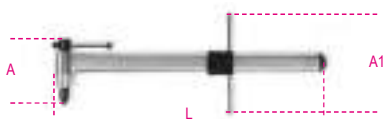

L mm 440 A mm 115 A1 mm 165 € 119,00 1 039210010

3923

Grampo para corte de espigões do selim até 80mm e tubos 1" ÷ 1.1/2"

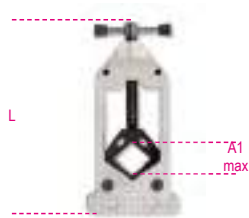

L mm 160 A1 max mm 80 Ø max mm 45 € 56,50 1 039230010

3927

Grampo para guidador



3927 L mm 365 € 34,00 1 039270010

3932U

Ferramenta para correntes compatível com correntes de 5 a 11 velocidades



L mm 164 L1 mm 115 € 62,50 1 039320011

3935

Ferramenta de verificação do desgaste das correntes



L mm 120 € 10,70 1 039350010

3937

Alicate para elos de correntes

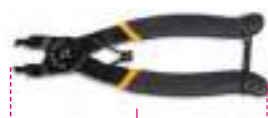

L mm 170 € 27,50 1 039370010

3948

Extrator do crenque/braço do pedal



Ø mm 14 L mm 79 Ø mm 20 € 21,30 1 039480015

3952

Chave de cones simples



Ø mm	L mm	€	1	039520013
13	205	27,50	2	039520013
14	205	27,50	2	039520014
15	205	27,50	2	039520015
16	205	27,50	2	039520016
17	205	27,50	2	039520017
18	205	27,50	2	039520018
19	205	27,50	2	039520019
20	205	28,00	1	039520020
21	205	28,00	1	039520021
22	205	28,00	1	039520022
24	205	29,00	1	039520024



3952/S7	€	1	039520207
13-14-15-16	191,00	1	039520207
17-18-19 mm			
3952/S11	€	1	039520211
13-14-15-16	304,00	1	039520211
17-18-19-20-21-22-24 mm			

3953

Chave de boca para pedais



Ø mm 15 L mm 401 € 42,50 1 039530015

3955

Chave de bocas para caixas de direção universais



Ø mm	L mm	€	1	039550108
30x32	292	39,50	1	039550108
32x36	319	43,50	1	039550114

3961,3,2

Chave para raios, preta, 3,2 mm



Ø mm 3,2 € 15,50 1 039610032

39613,3

Chave para raios, verde, 3,3 mm



mm 3,3 € 15,50 1 039610033

39613,5

Chave para raios, vermelha, 3,5 mm



mm 3,5 € 15,50 1 039610035

3961U

Chave múltipla para raios, 3,2 - 4,0 mm



mm 3,2 - 4,0 € 25,50 1 039610100

3962SH

Chave dupla para raios Shimano



L mm 132 A1 mm 4,3 A2 mm 4,4 € 19,70 1 039620010

3962MV

Chave dupla para raios Mavic



L mm 135 A1 mm 4,3 A2 mm 8,4 € 20,40 1 039620020

3963P

Chave especial para raios planos



L mm 129 € 9,30 1 039630010

3964

Chave especial para cabeça do raio



L mm 170 L1 mm 89 € 23,00 1 039640010

3965

Verificador de alinhamento das rodas, \varnothing 20" \div 29"



L mm 680 € 113,00 1 039650010

3965C

Suporte para alinhar rodas



- Adequado para rodas \varnothing 20" \div 29"
- Através de adaptador para cubo do eixo, 10 \div 20mm



L mm 500 L1 mm 380 A mm 285 € 454,00 1 039650110

3967

Ferramenta de bloqueio da cremalheira



- Adequado para cremalheiras até 11 carretos
- Punho em PVC bicomponente
- Também adequado para cremalheiras fixas



L mm 289 € 62,00 1 039670010

3969

Alavanca metálica de pneus



L mm 200 A mm 15,6 € 11,30 1 039690010

3969K3

Kit de 3 alavancas de plástico, para pneus



L mm 113 € 6,30 1 039690130

3971

Chave para parafusos de plástico Shimano



- Adequado para Shimano Hollowtech II cranksets



N° 8 mm 8 € 13,80 1 039710010

3972

Chave de extração do eixo de tração



- Adequado para Shimano® Hollowtech II, Campagnolo® Ultra-torque, FSA®, SRAM®



L mm 252 € 26,50 1 039720010

3973PF

Extrator de rolamentos Press-Fit



- Adequada para \varnothing interiores 24 mm e 30 mm



L mm 240 € 35,50 1 039730001

3973/1

Chave de extração do eixo de tração com 16 entalhes



- Adequado para Shimano® XTR BB93, Dura-Ace® BB9000

12"

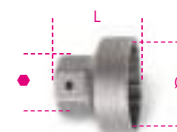

\varnothing mm 39 mm 24 L mm 34 € 22,80 1 039730010

3973/2

Chave de extração do eixo de tração com 16 entalhes

• Adequado para Shimano® BBR60 (Ultegra® 11 speeds)

12"



Ø mm	mm	L mm	€	1	039730020
41	24	35	22,80		

3973/3

Chave de extração do eixo de tração com 16 entalhes

• Adequado para Shimano® Hollowtech II, Campagnolo® Ultra-torque, FSA®, SRAM®

12"



Ø int. mm	mm	L mm	€	1	039730030
46	24	53,5	22,80		

3973/4

Chave extração do eixo de tração com 20 entalhes, com pino central, niquelada

• Adequado para Shimano e ISIS

12"



Ø mm	L mm	mm	€	1	039730040
31,5	55	24	14,40		

3975

pressa de montagem de rolamentos

• adequada para montagem de caixas de direção 1", 1.1/8", 1.1/4", 1.1/2" e 2"

NB: Não deve ser utilizada com caixas de direção "zero stack"



L mm	Ø mm	€	1	039750010
360	16x1	301,00		

3984/1

Chave de extração de cremalheira BMX, 4 pinos



Ø mm	L mm	mm	€	1	039840010
35	25,5	24	16,80		

3984/2

Chave de extração de cremalheira Shimano



Ø mm	L mm	mm	€	1	039840020
22,8	26	24	10,70		

3984/3

Chave de extração de cremalheira Shimano, cassete com pino guia

12"

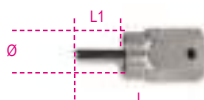

Ø mm	L mm	L1 mm	€	1	039840030
23,5	65	25	18,30		

3984/4

Chave de extração de cremalheira Campagnolo, com pino guia



Ø mm	L mm	L1 mm	mm	€	1	039840040
23	51	13	24	23,90		

3984/5

Chave de extração de cremalheira, 2 pinos

12"



Ø mm	L mm	mm	€	1	039840050
18,5	38	21	16,80		

3984/6

Chave de extração de cremalheira, 4 pinos

12"



Ø mm	L mm	mm	€	1	039840060
19,5	36	21	16,80		

3991

Alavanca para os freios do disco de travão



L mm	A mm	α	€	1	039910010
222	36	7°	40,00		

3992

Alinhador de discos de travão



L mm	A1 mm	€	1	039920010	
234	55	2,2	30,00		

2115PI/BIKE-HOME



2115PI/BIKE-HOME	361
------------------	-----

M400



M400	543
MV400	543

M401



M401	543
MV401	543

MM400



MM400	548
MMV400	548

MM401



MM401	548
MMV401	548

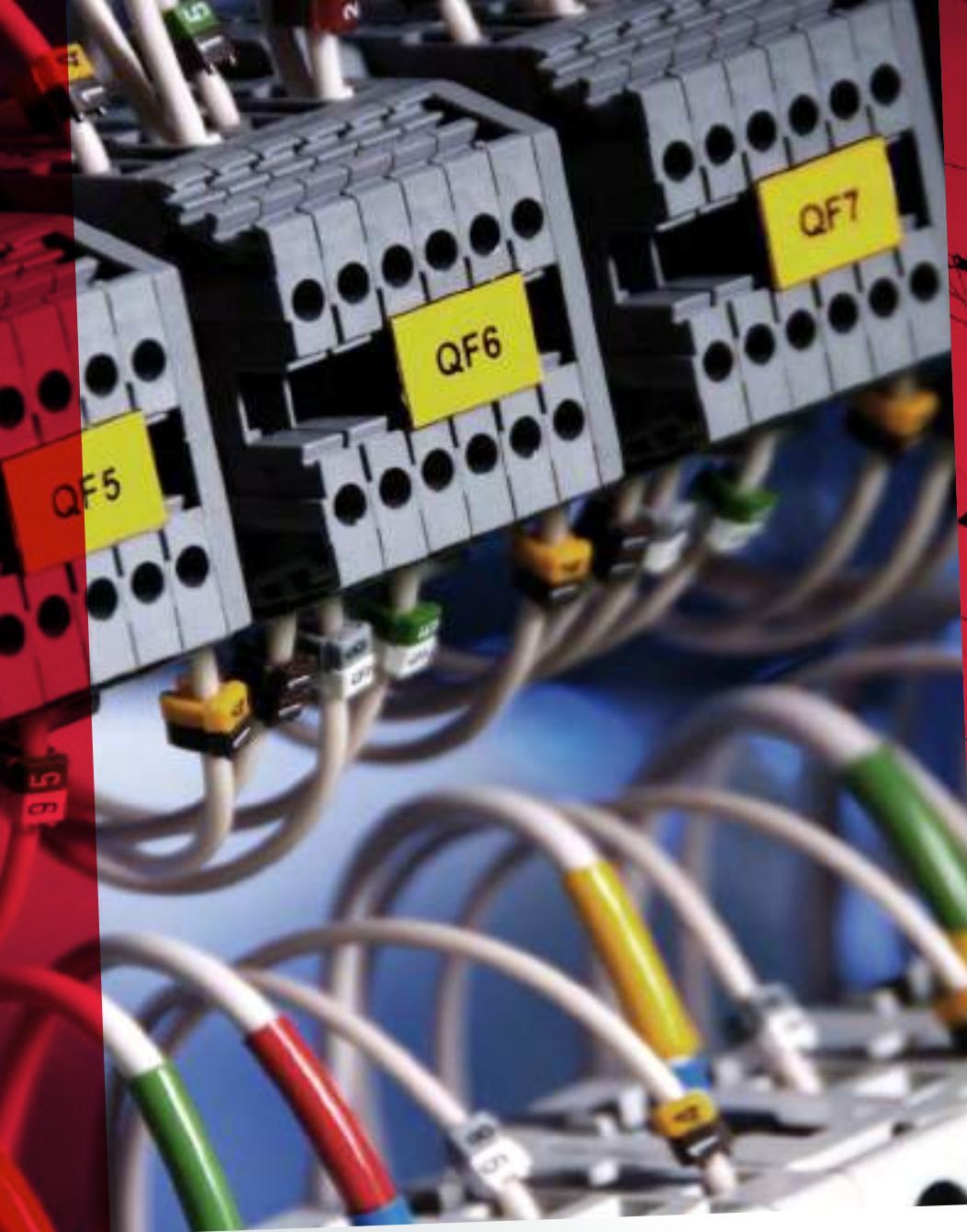

FERRAMENTAS ISOLADAS

As ferramentas isoladas Beta Utensili destinam-se a garantir a segurança nos trabalhos de instalação e manutenção eléctrica. Todas as ferramentas isoladas possibilitam trabalhar em sistemas de corrente alternada até 1000V e até 1500V em corrente contínua.

Para fornecer a melhor qualidade nos padrões de desempenho e possuir a adequada conformidade com a norma EN 60900, cada ferramenta é submetida a testes rigorosos: resistência a escorregamento dos punhos, propagação de chamas e teste de alta tensão(10000V).

Para jogos e módulos de ferramentas, consultar as respectivas secções.

Todas as ferramentas isoladas Beta são fabricadas de acordo com as especificações da EN60900 e aprovadas pelas principais instituições de certificação europeias



Istituto Italiano del Marchio di Qualità - I



Verband der Elektrotechnik
Elektronik Informationstechnik - D

1000 V

TESTES DE SEGURANÇA: testadas a 10.000 V para trabalhar em instalações elétricas de 1.000 V.

As ferramentas de elevado isolamento da Beta são testadas peça a peça a 10 kV, com o objetivo de proporcionar uma qualidade incomparável aos instrumentos de trabalho necessários para garantir padrões de segurança extremamente elevados: estas possibilitam o trabalho com voltagens até 1.000 V a.c. (1.500 V d.c.).

NORMAS DE SEGURANÇA:

Embora sejam realizados testes extremamente rigorosos durante a produção, antes de utilizar uma ferramenta, o operador deve sempre verificar o punho isolante quanto a fissuras, modificações ou danos. Manter as propriedades dielétricas inalteradas ao longo tempo está intimamente ligado ao stress mecânico, químico ou térmico ao qual a ferramenta pode estar sujeita. Caso o isolamento fique danificado, a ferramenta não pode ser considerada segura para utilização em instalações vivas. Utilize sempre óculos de proteção e luvas isoladas.

TESTES REALIZADOS DURANTE A PRODUÇÃO



Teste visual 100%:

Todos os acabamentos de superfície das ferramentas devem estar livres de defeitos visíveis externamente.



Teste de colisão:

Após 2 horas a -25 °C, a ferramenta é atingida três vezes (com um peso específico, conforme previsto na norma); o punho isolante não deve apresentar sinais de danos.



Teste de penetração:

Aplica-se um peso de 2 kg ao punho da ferramenta a +70 °C durante duas horas. Posteriormente, é aplicada uma voltagem de 5 kV na área sujeita a pressão mecânica durante 3 minutos. Não deve apresentar qualquer sinal de passagem de corrente.



Ensaio mecânico:

As ferramentas devem atender aos requisitos de desempenho mecânico previstos nas normas ISO relevantes.



Teste de propagação da chama:

Uma chama é direcionada para a ferramenta durante 10 segundos; durante os 20 segundos seguintes a chama não deve exceder uma altura de 120 mm.



Teste dimensional:

Todas as dimensões das ferramentas devem atender às especificações do projeto.



Teste de isolamento elétrico:

Após imersão em água durante 24 horas, a ferramenta é submetida a uma voltagem de 10 kV durante 3 minutos. A dissipação da corrente não deve exceder os valores previstos na norma.



500N

Teste de aderência:

Após 168 horas a +70 °C, a ferramenta é submetida a uma carga de 500 N para verificar se o punho não escorrega.



Teste de indelebilidade da marcação:

Após o teste de atrito com álcool isopropílico, as marcações devem permanecer legíveis.



52MQ

chaves de bocas simples isoladas



1000 V

EN 60900

Ø mm	L mm	€	U	U
6	90	35,00	1	000520106
7	96	35,00	1	000520107
8	100	35,00	1	000520108
9	108	35,00	1	000520109
10	110	35,00	1	000520110
11	120	35,00	1	000520111
12	132	37,50	1	000520112
13	140	39,50	1	000520113
14	146	40,50	1	000520114
15	166	42,00	1	000520115
16	156	45,50	1	000520116
17	168	45,50	1	000520117
18	170	47,00	1	000520118
19	176	47,00	1	000520119
21	190	51,50	1	000520121
22	200	51,50	1	000520122
24	225	55,50	1	000520124
27	210	72,50	1	000520127
30	240	76,00	1	000520130
32	240	77,50	1	000520132

89MQ

chaves de luneta



1000 V

EN 60900

Ø mm	L mm	€	U	U
6	150	45,00	1	000890106
7	155	45,00	1	000890107
8	155	45,00	1	000890108
9	160	45,00	1	000890109
10	170	45,00	1	000890110
11	180	45,00	1	000890111
12	190	49,00	1	000890112
13	195	52,50	1	000890113
14	200	55,50	1	000890114
15	210	56,50	1	000890115
16	216	60,00	1	000890116
17	218	60,00	1	000890117
18	236	64,50	1	000890118
19	240	64,50	1	000890119
21	250	73,50	1	000890121
22	255	73,50	1	000890122
24	280	83,50	1	000890124
27	300	88,50	1	000890127
30	320	104,00	1	000890130
32	340	106,00	1	000890132

110MQ

chave de abertura variável com escala



1000 V

EN 60900

L mm	A max	€	U	U
200	28	90,00	1	001100520
250	30	104,00	1	001100525
300	30	152,00	1	001100530

606MQ/50

chave dinamométrica com desarme sonoro e com roquete reversível



EN 60900
UNI EN 26789
ISO 6789

Nm	Kgfm	lbf.ft	A mm	L mm	i g
5÷50	0,5÷5	4÷40	90	375	1130

606MQ/50	€	1	006060705
	870,00		

850MQ

porta bits magnético, isolado, com punho de 2 componentes



IMQ CSV
EN 60900

L mm	L1 mm	D mm	€	1	008500910
233	125	12.5	26,50		

910MQ/B

chaves de caixa bi-sextavadas



EN 60900

Ø mm	L mm	Ø1 mm	Ø mm	€	1	009100616
6	45	14	24	32,00		
7	45	15	24	32,00		
8	45	16	24	32,00		
9	45	17	24	32,00		
10	45	19	24	32,00		
11	45	20	24	32,00		
12	45	24	24	32,00		
13	45	24	24	32,00		
14	45	25	24	32,00		
15	45	27	24	33,50		
16	45	27,5	24	33,50		
17	45	30	24	34,50		
18	45	31	24	34,50		
19	45	32	24	34,50		

910MQ/PE

chaves de caixa para parafusos sextavados



EN 60900

mm	Ø mm	L mm	€	1	009100604
4	24	100	36,00		
5	24,5	100	36,00		
6	25,0	100	36,00		
8	25,0	100	36,00		
10	25,5	100	37,50		

910MQ/TX

chaves de caixa de perfil Torx®



EN 60900

T	Ø mm	L mm	L1 mm	€	1	009100641
T15	23	116	61	45,50		
T20	24,5	116	65	45,50		
T25	24,5	116	65	45,50		
T27	24,5	116	65	45,50		
T30	24,5	116	65	46,50		
T40	24,5	116	65	47,00		

910MQ/XZN

chaves de caixa de perfil XZN®



EN 60900

M	Ø mm	L mm	L1 mm	€	1	009100658
M8	24	106	57	42,50		
M10	24	106	57	44,00		

910MQ/PT

extensões com quadra fêmea de 3/8"



EN 60900

Nm	L mm	L1 mm	€	1	009100801
12	80	35,5	240,00		

910MQ/21

extensão quadra 3/8"



EN 60900

L mm	Ø mm	€	1	009100804
140	13,4	58,00		

910MQ/22

extensão quadra 3/8"



EN 60900

L mm	Ø mm	€	1	009100805
265	13,4	63,50		

910MQ/T

punho em T, encabado 3/8"



EN 60900

L mm	L1 mm	€	1	009100807
200	165	69,00		

910MQ/55

roquete reversível quadra de 3/8"



EN 60900

L mm	D mm	A mm	€	1	009100808
203	41	67	197,00		

910MQ/C16

8 chaves de caixa bisextavadas, 4 chaves de caixa sextavadas com ponta macho e 4 acessórios



EN 60900

910MQ/C16	€	1	009100917
	860,00		

○ 910MQ/B	8 - 10 - 11 - 12 - 13 - 14 - 17 - 19 mm
○ 910MQ/PE	4 - 5 - 6 - 8 mm
910MQ/21	125 mm
910MQ/22	250 mm
910MQ/T	
910MQ/55	

914MQ/A

chaves de caixa sextavadas, quadra fêmea 3/8", em tecnopolímero especial à base de poliamida

Especialmente desenhada para baterias de carros híbridos e elétricos

Para utilização com chaves dinamométricas

3/8"



EN 60900

Ø mm	Ø mm	L mm	Ø1 mm	€	U	U
8	17,5	45	20	16,70	2	009140008
10	20,5	45	20	16,70	2	009140010
13	24	45	20	16,70	2	009140013
17	30	45	22	16,70	2	009140017

3/8"



EN 60900

914MQ-A/S4	€	U	U
8-10-13-17 mm	67,00	1	009140054

920MQ/A

chaves de caixa bocas hexagonais

1/2"



EN 60900

Ø mm	Ø mm	L mm	Ø1 mm	€	U	U
8	21,5	57	27,5	32,00	1	009200238
9	21,5	57	27,5	32,00	1	009200239
10	21,5	57	27,5	32,00	1	009200240
11	21,5	57	27,5	32,00	1	009200241
12	23,0	57	27,5	32,00	1	009200242
13	23,0	57	27,5	32,00	1	009200243
14	23,0	57	27,5	33,00	1	009200244
16	23,0	57	27,5	33,50	1	009200246
17	30,0	57	27,5	33,50	1	009200247
18	32,0	57	27,5	34,50	1	009200248
19	32,2	57	27,5	34,50	1	009200249
20	32,0	57	27,5	39,00	1	009200250
21	34,0	57	27,5	39,00	1	009200251
22	36,0	57	27,5	39,00	1	009200252
24	39,0	57	27,5	40,00	1	009200254
27	42,0	57	27,5	40,50	1	009200257
30	44,0	57	27,5	42,00	1	009200260
32	48,0	57	27,5	43,00	1	009200262

920MQ/PE

chaves de caixa para parafusos sextavados

1/2"



1000 V

EN 60900

*	Ø mm	L mm	L1 mm	€	U	U
4	28,5	94,50	10,5	54,00	1	009200264
5	28,5	94,5	10,5	54,00	1	009200265
6	28,5	94,5	10,5	54,00	1	009200266
8	28,5	94,5	10,5	54,00	1	009200268
10	28,5	94,5	10,5	56,00	1	009200267
12	28,5	94,5	10,5	56,00	1	009200269

920MQ/21

extensão com quadras macho e fêmea de 1/2"

1/2"



EN 60900

L mm	Ø mm	€	U	U
135	28	62,00	1	009200804

920MQ/22

extensão com quadras macho e fêmea de 1/2"

1/2"



EN 60900

L mm	Ø mm	€	U	U
264	30	70,00	1	009200805

920MQ/T

punho em T com quadra macho de 1/2"

1/2"

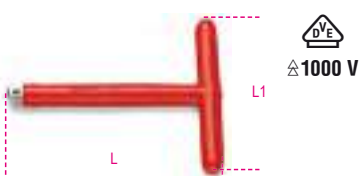

EN 60900

L mm	L1 mm	€	U	U
200	163	73,50	1	009200807

920MQ/55A

roquete reversível com quadra macho de 1/2" com sistema de bloqueio

1/2"



EN 60900

L mm	D mm	A mm	€	U	U
240	50	89	263,00	1	009200809

920MQ/C16

9 chaves de caixa sextavadas, 3 pontas para parafusos sextavados e 4 acessórios

1/2"



EN 60900

920MQ/C16	€	U	U
	1.010,00	1	009200917

920MQ/A	8 - 10 - 12 - 13 - 14 - 17 - 19 - 22 - 24 mm
920MQ/PE	5 - 6 - 8 mm
920MQ/21	135 mm
920MQ/22	264 mm
920MQ/55A	
920MQ/T	

420x280x60 mm - 5,2 kg

943MQ

chaves de caixa com punho boca hexagonal



EN 60900

Ø mm	L mm	L1 mm	D mm	€	U	U
5,5	233	125	12,2	20,90	1	009430235
6	233	125	12,5	20,90	1	009430236
7	240	125	14,3	22,20	1	009430237
8	240	125	15,3	22,80	1	009430238
10	252	125	17,3	23,60	1	009430240
13	252	125	21,3	26,00	1	009430243



943MQ/S6	€	U	U
5,5-6-7-8-10-13 mm	137,00	1	009430250

951MQ

chaves macho hexagonal com punho em T



EN 60900

mm	L mm	L1 mm	€	U	U
3	120	105	52,50	1	009510703
* 4	165	105	54,00	1	009510704
* 5	170	105	54,00	1	009510705
* 6	168	105	54,00	1	009510706
* 8	165	105	55,00	1	009510708
10	200	105	57,00	1	009510710

993MQ

pinça com pontas curvas estriadas



EN 60900

L mm	€	1	009930040
147	44,00	1	009930040

994MQ

pinça com pontas curvas estriadas



EN 60900

L mm	€	1	009940040
145	43,00	1	009940040

1010MQ

alicates de pontas longas redondas



EN 60900

L mm	L1 mm	€	1	010100096
160	51,5	53,00	1	010100096

1048MQ

Alicate ajustável, charneira fechada, isolado acabamento cromado

• Acabamento cromado



EN60900

L mm	A max mm	L1 mm	€	1	010480315
250	48	39	78,00	1	010480315

1082MQ

alicates de corte diagonal



EN 60900

L mm	L1 mm	€	1	010820094
140	20	52,50	1	010820094
160	22	55,00	1	010820096

1084MQ

alicates de corte de diagonal para serviços pesados



EN 60900

L mm	L1 mm	€	1	010840100
200	26	69,00	1	010840100

1088MQ

alicates de corte frontal



EN 60900

L mm	L1 mm	€	1	010880096
160	7	65,50	1	010880096

1128MQ

tesoura de electricista, lâminas em aço inox, com microdentes



IEC60900

L mm	L1 mm	€	1	011280101
145	45	54,50	1	011280101

1132MQ

alicate para cortar cabos de cobre e alumínio, com punhos isolados



EN 60900

L mm	€	1	011320193
230	101,00	1	011320193

1142MQ

alicate de descarnar fio



EN 60900

L mm	€	1	011420096
160	58,00	1	011420096

1150MQ

alicates universais em cromado brilhante



EN 60900

L mm	L1 mm	€	1	011500496
160	37	49,50	1	011500496
180	39	54,50	1	011500498
200	43	57,00	1	011500500
220	46	62,50	1	011500502

1162MQ

alicates de pontas extra-longas chatas



EN 60900

L mm	L1 mm	€	1	011620096
160	56	54,00	1	011620096
200	76	57,00	1	011620100

1164MQ

alicate de pontas curvas chatas extra-longas



L mm	L1 mm	€	1	011640096
160	54	56,00	1	011640096
200	76	59,00	1	011640100

1166MQ

alicates de pontas semi-redondas extra-longas



EN 60900

L mm	L1 mm	€	1	011660096
160	56	54,00	1	011660096
200	76	57,00	1	011660100

1168MQ

alicates de pontas curvas semi-redondas extra-longas



EN 60900

L mm	L1 mm	mm	€	🔌	📄
160	50	1,6	56,00	1	011680096
200	70	1,6	59,00	1	011680100

1169MQ/D2

Jogo de alicates, alicate universal (1 und.) e alicate de corte diagonal (1 und.)



1000 V

1169MQ/D2	€	🔌	📄
1150MQ 180 mm	110,00	1	011690152
1082MQ 160 mm			

1272MQF

chaves para parafusos de perfil Phillips®

Slim



EN60900

PHxDxL mm	L1 mm	€	🔌	📄
1x4,5x80	187	15,80	3	012720609
2x6x100	218	17,80	3	012720618

1272MQ

chaves para parafusos de perfil Phillips®

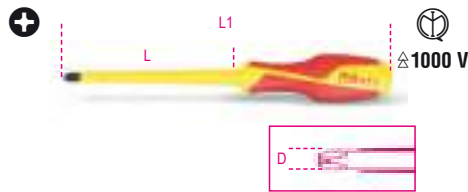

EN 60900

PHxDxL mm	L1 mm	€	🔌	📄
0x3x60	160	10,60	3	012720703
1x4,5x80	187	13,00	3	012720709
2x6x100	218	14,80	3	012720718
3x8x150	276	19,20	2	012720724
4x10x200	326	22,80	2	012720727



1272MQ/S5	€	🔌	📄
PH0x3x60-PH1x4,5x80 PH2x6x100-PH3x8x150 PH4x10x200 mm	80,50	1	012720751

1273MQF/D...

jogo de 6 chaves para parafusos estreitas



1273MQF/D4	€	🔌	📄
1272MQF 1x4,5x80-2x6x100 mm 1274MQF 0,6x3,5x100-1x5,5x125 mm	63,00	1	012730604

1273MQF/D6	€	🔌	📄
1272MQF 1x4,5x80-2x6x100 mm 1274MQF 0,6x3,5x100-1x4,5x100 1x5,5x125-1,2x6,5x150 mm	97,00	1	012730606

1273MQ/D6

jogo de 6 chaves de fenda



1273MQ/D6	€	🔌	📄
1274MQ 0,5x3x100 -0,8x4x100 1,0x5,5x125 mm 1272MQ PH0x3x60 -PH1x4,5x80 PH2x6x100 mm	76,00	1	012730851

1274MQF

chaves para parafusos de perfil de fenda sem cabeça

Slim



EN60900

SxDxL mm	L1 mm	€	🔌	📄
0,6x3,5x100	200	13,50	3	012740603
1x4,5x100	205	15,00	3	012740606
1x5,5x125	232	15,90	3	012740609
1,2x6,5x150	268	19,00	3	012740612

1274MQ

chaves para parafusos de perfil de fenda sem cabeça

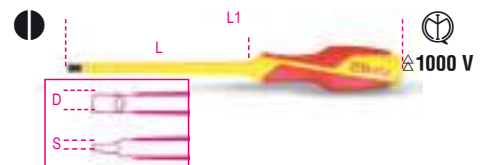

EN 60900

SxDxL mm	L1 mm	€	🔌	📄
0,4x2,5x75	175	10,30	3	012740700
0,5x3x100	200	10,80	3	012740703
0,8x4x100	207	12,80	3	012740706
1x5,5x125	232	13,60	3	012740709
1,2x6,5x150	268	16,50	3	012740712
1,2x8x175	301	19,20	2	012740715
1,6x10x200	326	22,70	2	012740718



1274MQ/S6	€	🔌	📄
0,5x3x100-0,8x4x100 1x5,5x125-1,2x6,5x150 1,2x8x175-1,6x10x200 mm	95,50	1	012740751

1275MQ/C

Chave combinada para parafusos de fenda + cabeça em cruz PH

espessura reduzida



EN60900

🔌	📄	€	🔌	📄
PH1+LPP	14,50	2	012750409	
PH2+LPP	16,50	2	012750418	

1276MQ/C

Chave combinada de parafusos PZ + cabeça com fenda

espessura reduzida

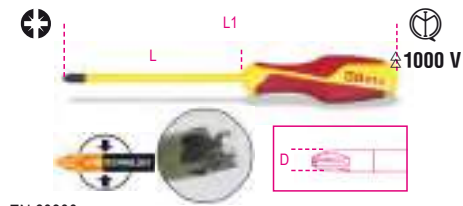

EN 60900

	€		
☉ PZ1+LPP	13,70	2	012760409
☉ PZ2+LPP	15,50	2	012760418

1279MQ/F

Chave de parafusos Pozidriv®-Supadriv®

espessura reduzida

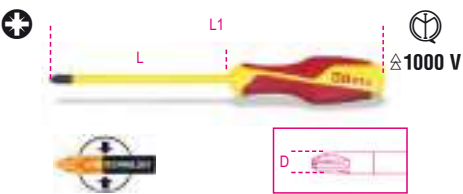

EN60900

pz	L mm	L1 mm	€		
1	80	187	14,50	3	012790409
2	100	218	16,50	3	012790418

1279MQ

chave de fenda para parafuso de perfil Pozidriv® - Supadriv®



EN 60900

PZ	L mm	L1 mm	€		
0	60	160	10,90	3	012790703
1	80	187	13,20	3	012790709
2	100	218	15,20	3	012790718
3	150	276	20,00	2	012790724



	€		
1279MQ/S4 PZ 0-1-2-3	59,00	1	012790751

1725MQ

mini serrote



EN 60900

	€		
1725MQ	101,00	1	017250030

1777MQ/C

navalha de descarnar cabo, isolada

• para cabos multi-núcleos



EN 60900

	€		
1777MQ/C	40,50	1	017770026

1777MQ/U

navalha de descarnar cabo, isolada



EN 60900

	€		
1777MQ/U	37,00	1	017770011

1777RL/U

4 lâminas de substituição para 1777MQ/U



	€		
1777RL/U	29,00	1	017770021

1995MQ/T

tapete isolante

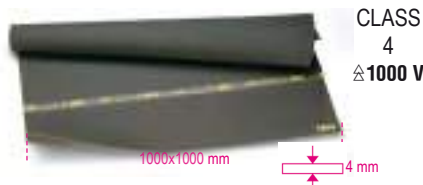

VDE 0303
EN 60243

	€		
1995MQ/T	336,00	1	019950030

1995MQ/G1 - G2

luvas isolantes em látex



EN 60903

	€		
1995MQ/G1	134,00	1	019950010
1995MQ/G2	134,00	1	019950013

1996MQ/T

Pano isolante

500x500mm

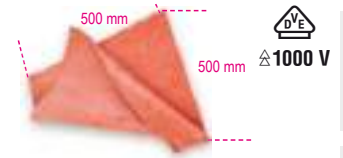

DIN EN 61112

	€		
1996MQ/T0,5	102,00	1	019960005

1996MQ/GM

Luvas isolantes

EN60903
EN388



EN 60903
EN 61482

	€		
1996MQ/GM 9	172,00	1	019960109
1996MQ/GM 10	172,00	1	019960110

1996SVG

Teste pneumático para luvas isolantes

teste obrigatório conforme norma EN90603



	€		
1996SVG	394,00	1	019960133

2115P L-MQ32



2115PL-MQ32	362
-------------	-----

2029EM



2029EM	355
--------	-----

5989 VEM



5989 VEM	517
----------	-----



FERRAMENTAS ANTI-QUEDA

Beta H-SAFE

A gama de ferramentas H-SAFE de Beta inclui mais de 200 referências, para as quais foi projetado individualmente um sistema de retenção capaz de resistir às solicitações mecânicas mais rigorosas, como garantia de máxima segurança.

O conforto na utilização também é importante, nas chaves com utilização das duas extremidades, como a chave de boca/luneta art. 42, existe um cabo se movimenta ao longo de todo o corpo da ferramenta (foto), enquanto nas ferramentas manobradas com torção, por exemplo a chave de parafuso, existem anéis de rotação livre para não causar torção do cabo.



O sistema de retenção H-SAFE foi projetado, testado e fabricado nas unidades industriais Beta. Com o sistema de segurança H-SAFE de Beta as ferramentas estão sempre ao alcance da mão de forma confortável e segura.

35HS

escopros planos série nervurada H-SAFE



L mm	A mm	€	📦	📄
200	23,0	43,50	1	000354004
250	28,5	55,00	1	000354005

42HS

chaves mistas boca/luneta H-SAFE



DIN 3113 UNI-HSO 7738

📏 mm	L mm	€	📦	📄
6x6	95	22,40	1	000424506
7x7	105	22,70	1	000424507
8x8	116	22,90	1	000424508
9x9	127	23,60	1	000424509
10x10	137	23,90	1	000424510
11x11	148	24,50	1	000424511
12x12	158	24,80	1	000424512
13x13	169	25,00	1	000424513
14x14	180	26,50	1	000424514
15x15	190	26,50	1	000424515
16x16	201	27,00	1	000424516
17x17	212	28,50	1	000424517
18x18	222	29,00	1	000424518
19x19	233	29,50	1	000424519
20x20	243	30,50	1	000424520
21x21	254	32,50	1	000424521
22x22	264	33,50	1	000424522
23x23	275	35,00	1	000424523
24x24	285	37,00	1	000424524
25x25	296	37,00	1	000424525
26x26	307	38,00	1	000424526
27x27	317	40,50	1	000424527
28x28	328	41,00	1	000424528
29x29	338	45,00	1	000424529
30x30	349	46,50	1	000424530
32x32	370	51,50	1	000424532
34x34	391	84,50	1	000424534
36x36	412	93,00	1	000424536

42HS/AS

chaves mistas boca/luneta H-SAFE



📏 mm	L mm	€	📦	📄
1/4x1/4	95	24,30	1	000424106
5/16x5/16	116	24,50	1	000424108
3/8x3/8	137	26,00	1	000424110
7/16x7/16	148	26,50	1	000424111
1/2x1/2	169	26,50	1	000424113
9/16x9/16	180	27,00	1	000424114
5/8x5/8	201	29,00	1	000424116
11/16x11/16	212	30,50	1	000424117

Ø	L	€		
"	mm			
3/4	233	32,50	1	000424119
13/16	254	36,00	1	000424121
7/8	264	37,00	1	000424122
15/16	285	40,50	1	000424124
1x1	296	41,50	1	000424125
1.1/16	317	45,50	1	000424127
1.1/8	338	48,00	1	000424129
1.1/4	370	57,50	1	000424132
1.5/16	391	87,00	1	000424133

55HS

chaves de bocas H-SAFE



UNI-ISO 10102 DIN 3110

Ø	L	€		
mm	mm			
• 6x7	120	17,90	1	000554012
• 8x9	140	18,40	1	000554021
• 10x11	155	18,70	1	000554030
• 12x13	170	20,30	1	000554042
• 14x15	185	20,80	1	000554054
• 16x17	202	22,10	1	000554060
• 18x19	220	23,60	1	000554066
• 20x22	236	24,90	1	000554075
• 21x23	245	26,50	1	000554078
• 22x24	245	28,00	1	000554081
• 24x27	262	30,50	1	000554090
• 30x32	297	38,50	1	000554108
• 34x36	325	86,00	1	000554117

91HS-C

chaves de luneta inclinada para serviços pesados H-SAFE



Ø	Ø	€		
mm	mm			
36	54	105,00	1	000914036
41	62	123,00	1	000914041
46	69	143,00	1	000914046

91HS

chaves de luneta inclinada para serviços pesados H-SAFE



Ø	Ø	€		
mm	mm			
36	54	210,00	1	000914236
41	62	228,00	1	000914241
46	69	268,00	1	000914246

92HS

cabo tubular para a chave refª. 91 H-SAFE



L	91	Ø	€		
mm	mm	mm			
610	32÷41	22	105,00	1	000924020
760	46÷55	25	126,00	1	000924030

93HS

chave de lunetas com curvatura profunda especial para andaimes H-SAFE



Ø	L	€		
mm	mm			
21x22	310	61,00	1	000934021

96TBP-HS

chaves offset sextavadas cabeça de bola, com punhos de torque elevado e sistema de segurança H-SAFE



Ø	L	L1	Ø	€		
mm	mm	mm	mm			
2,5	153	55	4	28,50	1	000964685
3	153	55	4	29,50	1	000964686
4	179	70	5	30,00	1	000964687
5	200	84	6	30,50	1	000964688
6	221	103	7	33,00	1	000964689
8	255	117	10	38,50	1	000964690
10	285	132	12	42,00	1	000964692

96THS

chaves macho hexagonal com punho H-SAFE

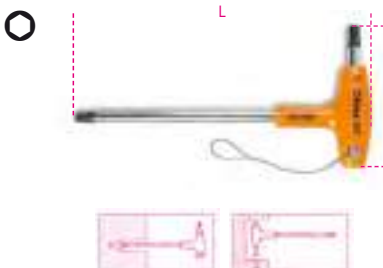

mm	L	L1	€		
mm	mm	mm			
2,5	153	55	27,50	1	000964935
3	153	55	28,00	1	000964936
4	179	70	28,50	1	000964938
5	200	84	29,00	1	000964940
6	221	103	31,00	1	000964941
8	255	117	37,00	1	000964943
10	285	132	40,00	1	000964945

96THS-AS

chaves macho hexagonal com punho H-SAFE



Ø	L	L1	Ø	€		
"	mm	mm	mm			
5/32	200	84	6	31,00	1	000964673
3/16	200	84	6	31,00	1	000964674
7/32	221	103	7	34,50	1	000964675
1/4	236	106	8	35,50	1	000964676
5/16	255	117	10	38,50	1	000964678
3/8	285	132	12	42,50	1	000964680

97TTXHS

chaves duplas macho com punho para parafusos com cabeça Torx® H-SAFE



Ø	L	L1	€		
T	mm	mm			
T10	179	70	28,00	1	000974710
T15	179	70	28,50	1	000974715
T20	179	70	29,00	1	000974720
T25	179	70	29,50	1	000974725
T30	200	84	34,00	1	000974730
T40	221	103	36,00	1	000974740
T45	236	106	39,00	1	000974745
T50	255	117	47,50	1	000974750

111E-HS

chaves ajustáveis com escalas, cromadas

com sistema de segurança H-SAFE

- Rotação do pino à direita
- Escala mm/polegadas



DIN 3117 ISO 6787

L	L	A max	€		
mm	mm	mm			
200	8	29	56,00	1	001114120
250	10	34	63,50	1	001114125
300	12	40	78,50	1	001114130
380	15	45	133,00	1	001114138
450	18	54	211,00	1	001114145

142HS

chaves boca/luneta com sistema de roquete H-SAFE

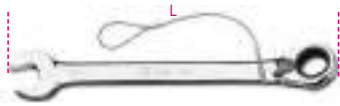

mm	L mm	€		
8x8	136	35,00	1	001424008
9x9	143	36,00	1	001424009
10x10	159	37,00	1	001424010
11x11	168	37,50	1	001424011
12x12	174	38,00	1	001424012
13x13	180	39,00	1	001424013
14x14	190	40,00	1	001424014
15x15	200	41,50	1	001424015
16x16	216	44,50	1	001424016
17x17	233	45,50	1	001424017
18x18	239	48,00	1	001424018
19x19	248	48,50	1	001424019
21x21	285	58,50	1	001424021
22x22	285	59,50	1	001424022
24x24	325	69,00	1	001424024
27x27	355	92,00	1	001424027
30x30	420	106,00	1	001424030
* 32x32	420	110,00	1	001424032

360HS

chaves para tubos modelo Stillson H-SAFE



L mm	Ø max " mm	€		
250	1" gas	57,00	1	003604025
350	1 1/2" gas	70,50	1	003604035
450	2" gas	91,50	1	003604045
600	2 1/2" gas	130,00	1	003604060



LC system, sistemade retenção com esfera dupla, com liberação da chave de caixa realizada apenas com o botão

666HS

chaves dinamométricas ZERO-RESET com roquetes reversíveis, para aperto à direita, precisão de torque: $\pm 3\%$

com sistema de fixação H-SAFE

• Não é necessário libertar a tensão



ISO 6789

Nm	□	D mm	A mm	L mm	LC system	g	kg
10÷50	3/8	30	33	342	-	680	0,25

€		
291,00	1	006664705

Nm	□	D mm	A mm	L mm	LC system	g	kg
20÷100	3/8	30	33	385	-	760	0,25

€		
295,00	1	006664710

Nm	□	D mm	A mm	L mm	LC system	g	kg
40÷200	1/2	42	43	471	*	1020	0,5

€		
332,00	1	006664721

Nm	□	D mm	A mm	L mm	LC system	g	kg
60÷300	1/2	42	43	600	*	1270	1,0

€		
373,00	1	006664731

900E-HS/55

roquete reversível H-SAFE



DIN 3122 - UNI-ISO 3315

L mm	Ø mm	A mm	□	€		
125	25	18	1/4	55,00	1	009004880

910E-HS/55

roquete reversível H-SAFE



DIN 3122 - UNI-ISO 3315

L mm	Ø mm	A mm	□	€		
200	30	33	3/8	61,00	1	009104880

920E-HS/55LC

roquete reversível H-SAFE com "Locking system"



DIN 3122 - UNI-ISO 3315

L mm	Ø mm	A mm	□	€		
275	40	43	1/2	89,50	1	009204860

932HS

chaves de cachimbo 6 faces/12 faces em cromado brilhante H-SAFE

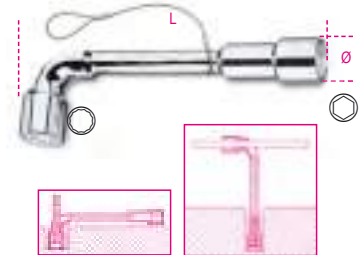

NF E 74.303

mm	Ø mm	L mm	€		
6x6	11,5	110	29,50	1	009324006
7x7	12,5	116	30,50	1	009324007
8x8	13,0	120	32,50	1	009324008
9x9	14,0	125	33,00	1	009324009
10x10	16,5	133	34,00	1	009324010
11x11	17,5	143	35,50	1	009324011
12x12	19,0	148	37,00	1	009324012
13x13	19,5	154	37,50	1	009324013
14x14	21,5	167	40,00	1	009324014
15x15	22,5	182	40,50	1	009324015
16x16	24,5	193	41,50	1	009324016
17x17	26,0	198	42,50	1	009324017
18x18	26,5	215	45,50	1	009324018
19x19	29,0	220	48,00	1	009324019

1032HS

alicates de freios interiores com pontas direitas e punhos em PVC H-SAFE



UNI 7914 DIN 5256

L mm	Ø mm	Ø1 mm	A mm	€		
140x1,3	12÷25	1,3	20	41,00	1	010324014
180	19÷60	1,9	21	43,50	1	010324017

Beta

1034HS

alicates de freios interiores com pontas curvas a 90° e punhos em PVC H-SAFE



UNI 7914 DIN 5256

L	∅	∅1	A	€	📦	📄
mm	mm	mm	mm			
170	19+60	1,9	21	46,00	1	010344017

1036HS

alicates de freios exteriores com pontas direitas e punhos de PVC H-SAFE



UNI 7915 DIN 5254

L	∅	∅1	A	€	📦	📄
mm	mm	mm	mm			
140x1,3	10÷25	1,3	20	43,50	1	010364014
175	19+60	1,9	21	44,50	1	010364017

1038HS

alicates de freios exteriores com pontas curvas a 90° e punhos em PVC H-SAFE



UNI 7915 DIN 5254

L	∅	∅1	A	€	📦	📄
mm	mm	mm	mm			
175	19+60	-	21	47,50	1	010384017

1048BM-HS

alicate ajustável, charneira fechada, punhos de 2 componentes H-SAFE

· novo modelo com 9 posições



ISO 8976

L	A max	L1	g	€	📦	📄
mm	mm	mm	g			
250	48	39	460	68,50	1	010484215

1052HS

alicates de pressão, maxilas côncavas H-SAFE

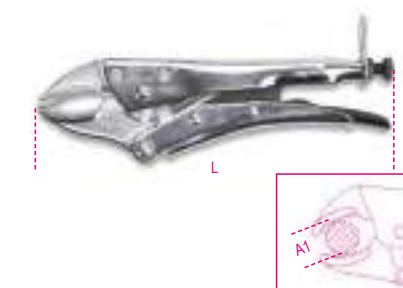

L	A	A1 max	S	€	📦	📄
mm	mm	mm	mm			
240	72	42	10,0	56,50	1	010524024

1082BM-HS

alicates de corte diagonal, punhos bi-material H-SAFE



UNI/ISO 5749

L	L1	mm	A	€	📦	📄
mm	mm	mm	mm			
160	22	1,6	28,0	55,50	1	010824036

1088BM-HS

alicates de corte frontal para serviços pesados, punhos bi-material H-SAFE



UNI/ISO 5748

L	L1	mm	A	€	📦	📄
mm	mm	mm	mm			
160	9	1,6	28,0	64,00	1	010884036
200	11	2,0	36,0	80,00	1	010884040

1128BAX-HS

Tesoura de electricista com perfis de escareação graduados, lâminas em aço inox com revestimento DLC H-SAFE

Gumes de corte duplo: pino excêntrico especial permite que as lâminas se movimentem a todo o comprimento, aumentando a eficiência de corte. H-SAFE

Concebida para alargar furos em plástico, de 13 mm a 25 mm.

Revestimento DLC (diamond-like carbon) é um revestimento inovador à base de carbono: a elevada dureza e baixo atrito resultam da combinação de carbono, sob a forma de grafite, e diamante.

- Elevada dureza da superfície da lâmina (resistência à abrasão e desgaste)
- Baixa fricção (suavidade e antiaderência)
- Pino excêntrico especial
- Punhos de grandes dimensões com ranhura para corte de cabos e cravagem de terminais
- Com caixa em plástico articulada



L	L1	mm ²	€	📦	📄
mm	mm	mm ²			
150	50	50	53,00	1	011284088



1132BM-HS

corta-cabos para cabos isolados de cobre alumínio com punhos bi-material H-SAFE



UNI 8791

L	A	B	€	🔧	📄
mm	mm	mm			
230	18	37	12,5	97,00	1 011324143

1150BM-HS

alicates universais em cromado brilhante com punhos bi-material H-SAFE



ISO 5746

L	L1	A	€	🔧	📄
mm	mm	mm			
160	42	1,6	22,0	48,00	1 011504146
180	46	1,8	25,0	50,50	1 011504148
200	50	2,0	27,0	55,50	1 011504150

1166BM-HS

alicates de pontas semi-redondas com estrias, extra-longas, e punhos bi-material H-SAFE



ISO 5745

L	L1	A	€	🔧	📄
mm	mm	mm			
200	76	1,6	22,0	57,00	1 011664040

1168BM-HS

alicates de pontas curvas semi-redondas com estrias, extra-longas, e punhos bi-material H-SAFE



ISO 5745

L	L1	A	€	🔧	📄
mm	mm	mm			
200	70	1,6	22,0	60,00	1 011684040

1290HS

chaves para parafusos de perfil de fenda H-SAFE



ISO 2380

SxAxL	L1	Ø	€	🔧	📄
mm	mm	mm			
0,4x2,5x75	171	2,5	19,80	1	012904006
0,5x3x100	196	3,0	20,50	1	012904012
0,6x3,5x100	196	3,5	21,80	1	012904021
0,8x4x100	196	4,0	21,40	1	012904030
0,8x4x150	246	4,0	22,80	1	012904036
1x5,5x150	259	5,0	25,50	1	012904042
1,2x6,5x150	270	6,0	27,00	1	012904051
1,2x8x150	282	7,0	29,50	1	012904057
1,6x10x200	332	8,0	35,00	1	012904066

1292HS

chaves para parafusos de perfil Phillips® H-SAFE



UNI/ISO 8764

PHxDxL	L1	€	🔧	📄
mm	mm			
0x3x100	196	20,70	1	012924006
1x4,5x120	229	22,90	1	012924012
2x6x150	270	27,50	1	012924021
3x8x150	282	31,50	1	012924024

1294HS

chaves para parafusos de perfil de fenda sem cabeça H-SAFE



SxDxL	L1	€	🔧	📄
mm	mm			
0,5x2,5x60	156	19,30	1	012944003
0,6x3x75	171	19,50	1	012944006
0,8x4x100	196	21,50	1	012944012
1x5x125	234	25,00	1	012944018

1299HS

chaves para parafusos de perfil Pozidriv® - Supadriv® H-SAFE



UNI/ISO 8764

PZ	L	L1	€	🔧	📄
	mm	mm			
0	60	156	21,70	1	012994000
1	80	189	24,30	1	012994003
2	100	220	29,50	1	012994006
3	150	282	37,50	1	012994009

1370T-HS

martelos para mecânica cabo em fibra H-SAFE



g	A	L	L1	€	🔧	📄
	mm	mm	mm			
300	23	300	105	41,00	1	013704630
500	27	320	118	44,00	1	013704650
1000	36	360	135	55,50	1	013704700

Beta

Beta

1370FT-HS

martelos para mecânicos, cabos em fibra H-SAFE



A mm	L mm	L1 mm	B mm	€	📦	📄
28	280	86	22	56,50	1	013704528
30	280	92	24	57,00	1	013704530
36	300	104	29	67,50	1	013704536

1390HS

martelos com batentes plásticos intermutáveis, cabo em madeira H-SAFE



UNI 7784

D mm	L mm	L1 mm	€	📦	📄
35	310	95	52,00	1	013904035
45	320	107	73,50	1	013904045

1392HS

martelos anti-recuo com batentes intermutáveis, cabo em aço H-SAFE



D mm	L mm	L1 mm	€	📦	📄
35	305	115	75,00	1	013924035
40	310	125	84,00	1	013924040
50	325	135	98,00	1	013924050
60	385	155	143,00	1	013924060

1602A-HS

alicate para cravar terminais isolados modelo standard H-SAFE

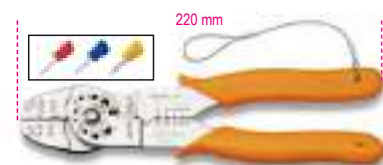

mm ²	L mm	A mm	B mm	€	📦	📄
0÷6	220	42	4	80,00	1	016024005

1682HS

réguas graduadas flexíveis em aço inoxidável H-SAFE

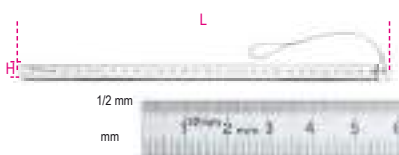

L mm	H mm	± mm	€	📦	📄
200	13	0,5	17,90	1	016824020
300	13	0,5	20,30	1	016824030

1692HS

fitas métricas, caixa em ABS anti-choque, fitas em aço, classe de precisão II H-SAFE



L m	S mm	€	📦	📄
3	16	24,30	1	016924053
5	19	28,50	1	016924055

1708HS/20

apalpa-folgas H-SAFE



S mm	S mm	L mm	€	📦	📄
0,05÷1,0	0,002÷0,040	105	26,50	1	017084020

1727HS

serrote, série pesada H-SAFE

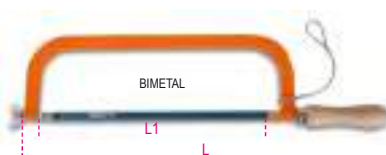

L mm	L1 mm	€	📦	📄
515	300	37,00	1	017274001

1743HS

alicate para abraçadeiras em Nylon H-SAFE

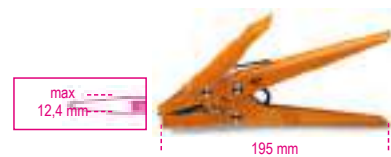

L mm	A mm	B mm	€	📦	📄
195	85	17	76,50	1	017434001

1750HS

pistola de massa H-SAFE



1 g, 550 bar Max

cc	L mm	€	📦	📄
500	380	64,50	1	017504500

1760BHS

múltímetro digital H-SAFE



ESPECIFICAÇÕES

Voltagem DC: 200 mV/2/20/200/1000V
 Voltagem AC: 2-20/200/700V
 Corrente DC: 2/20/200 mA-20 A
 Corrente AC: 2/200 mA- 20 A
 Resistência: 200Ω - 2/20/200 kΩ - 2/20 MΩ
 Capacidade: 2/20/200 nF - 2/200 μF
 Temperatura: -20° + 1000°C/-4 °F ~ +2000°F
 Frequência: 20kHz
 Potência de alimentação: Pilha 1 9V (incluída)

1760BHS	€	📦	📄
	253,00	1	017604012

1772H-HS

x-acto de lâmina retráctil, de segurança, lâmina de substituição H-SAFE



L mm	A mm	€		
170	18	33,00	1	017724029

1778SOS-HS

navalha manutenção automóvel com quebra-janelase cortante para cintos de segurança fornecida em bolsa H-SAFE



L mm	A mm	L1 mm	€		
205	25	85	53,00	1	017784080

8871

Cinto de segurança com fivela metálica de fecho duplo



	L cm min-max	€		
8871 70	70-100	150,00	1	088710070
8871 100	100-135	162,00	1	088710100

8872A

Passador fixo

• Para cinto 8871



8872A 50	€		
	26,50	1	088720050

8872AS

Passador com abertura auto-aderente

• Para cinto 8871



8872AS 25	D mm	€		
	25	24,30	1	088720525

8873

Saco porta-ferramentas com auto-aperto e fecho de correr

• Para cinto 8871



8873 230	€		
	127,00	1	088730230

8877

Elemento de conexão com amortecimento

• MAX 2.7 kg



8877 80	L cm min+max	DxL mm	€		
	70-110	40x80	32,50	1	088770080

8877M

Elemento de conexão com amortecimento

• Com junta antitorção
• MAX 2.7 kg



8877M 20-140	L cm min+max	DxL mm	€		
	20-140	30x60	58,00	1	088770510

8879

Faixa para pulso auto-aderente

• MAX 2.7 kg



8879	D mm	€		
	30	37,50	1	088790025

8880

Amarração de conexão rígida

• Com junta antitorção



8880 30	L Cm	D mm	€		
	30	10	29,00	1	088800030

8883

Saco porta-ferramentas

• Em nylon 840 anti-abrasão• MAX 20 kg• Mosquetão para bloquear o fecho de correr no fim• 6 amarrações de retenção ferramenta• Com bolso interno



8883	DxH cm	€		
	30x40	307,00	1	088830030





FERRAMENTAS EM AÇO INOX



As Ferramentas BETA INOX podem ser utilizadas em ambientes críticos - ou seja, áreas onde não é permitido um nível mínimo de contaminação.

Alguns exemplos incluem:

- Aplicações nucleares
- Indústria farmacêutica - classe C
- Aplicações em plataformas off-shore
- Laboratórios biotecnológicos e biomédicos
- Indústria alimentar.

As ferramentas Beta Inox evitam a formação indevida de ferrugem.

Ao utilizar outras ferramentas em parafusos, porcas ou superfícies em aço inox, são libertadas algumas partículas que desencadeiam a corrosão. Muitas vezes isso resulta em problemas estéticos e, por vezes, também em problemas estruturais.

Alguns exemplos de aplicações:

- Estaleiros navais
- Construção
- Sistemas solares
- Indústria automóvel.



INOX + NO INOX
= FERRUGEM



INOX + INOX
= SEM FERRUGEM

CARACTERÍSTICAS

A selecção dos melhores materiais¹ e busca contínua do melhor tratamento térmico conferem às ferramentas Beta Inox características mecânicas que excedem largamente as normas em vigor, sendo comparáveis à restante gama de Ferramentas Beta.

Também apresentam características ergonómicas e de design idênticas à linha Beta tradicional, amplamente reconhecida e apreciada pelos utilizadores profissionais há mais de 75 anos.

O aço inox é 100% reciclável, o que também representa uma grande vantagem em termos ambientais.



Marcação para produtos em aço inox
Trata-se de uma marcação emitida pelo Centro Inox - Associação Italiana de Desenvolvimento de Aço Inoxidável, que caracteriza os produtos fabricados em aço inox.

34INOX

Escopros planos, em aço inox



L mm	A mm	Ø mm	€	🔧	📦
160	18	18	45,50	1	000340318
200	20	20	67,50	1	000340320

39INOX

Cunhas, em aço inox



L mm	A mm	S mm	€	🔧	📦
100	50	10	31,50	1	000390310
150	50	13	57,00	1	000390315
200	40	40	167,00	1	000390320

42INOX

chave boca/luneta em aço inox



DIN 3113 - UNI ISO 7738

🔧 mm	L mm	€	🔧	📦
6x6	95	15,90	2	000420306
7x7	105	16,50	2	000420307
8x8	116	16,60	2	000420308
9x9	127	17,80	2	000420309
10x10	137	18,90	2	000420310
11x11	148	20,40	2	000420311
12x12	158	21,30	2	000420312
13x13	169	21,50	2	000420313
14x14	180	22,30	2	000420314
15x15	190	22,90	2	000420315
16x16	201	23,50	2	000420316
17x17	212	26,50	2	000420317
18x18	222	28,50	2	000420318
19x19	233	30,50	2	000420319
21x21	254	37,50	1	000420321
22x22	264	38,50	1	000420322
24x24	285	42,50	1	000420324
27x27	290	124,00	1	000420327
30x30	320	151,00	1	000420330
32x32	340	164,00	1	000420332
36x36	360	230,00	1	000420336
38x38	430	246,00	1	000420338
41x41	430	288,00	1	000420341
46x46	480	330,00	1	000420343
50x50	520	356,00	1	000420345
55x55	560	385,00	1	000420347
60x60	595	429,00	1	000420350



42INOX/S11	240,00	1	000420391
6-8-10-11-12-13-14-15-16-17-19 mm			



42INOX/SC9	210,00	1	000420387
8-10-11-12-13-14-15-17-19 mm			
42INOX/SCV9	11,00	1	000420303

42INOX-AS

chaves combinadas, boca/luneta, em aço inoxidável



🔧 mm	L mm	€	🔧	📦
1/4x1/4	95	19,10	1	000420356
5/16x5/16	116	19,30	1	000420358
3/8x3/8	137	23,10	1	000420360
7/16x7/16	148	25,00	1	000420361
1/2x1/2	169	25,50	1	000420363
9/16x9/16	180	27,50	1	000420364
5/8x5/8	201	29,00	1	000420366
11/16x11/16	212	33,50	1	000420367
3/4x3/4	233	37,00	1	000420369
13/16x13/16	254	42,50	1	000420371
7/8x7/8	264	44,50	1	000420372
15/16x15/16	285	50,50	1	000420373



42INOX-AS/S9	239,00	1	000420396
1/4-5/16-3/8-7/16-1/2-9/16-5/8-11/16-3/4			



96BPINOX

chave sextavada cabeça de bola, em aço inox



mm	L mm	L1 mm	g	€	🔧	📦
2	91	22	4	5,60	4	000961441
2,5	91	22	6	5,60	4	000961442
3	101	24	11	5,90	4	000961443
4	112	29	19	6,70	4	000961444
5	131	33	32	7,90	4	000961445
6	154	36	51	8,70	4	000961446
7	164	40	65	11,30	2	000961447
8	175	44	116	13,80	2	000961448
10	197	51	189	17,10	2	000961450



96BPINOX/B6	55,00	1	000961455
2,5-3-4-5-6-8 mm			
96BPINOX/B9	89,00	1	000961456
2-2,5-3-4-5-6-7-8-10 mm			
96BPINOX/BV	6,80	1	000961459

96BPINOX-AS

chaves de bola sextavadas, em aço inoxidável



"	L mm	L1 mm	g	€	🔧	📦
5/64	91	22	5,5	7,20	4	000961989
3/32	91	22	5,3	7,20	4	000961990
7/64	101	24	10,5	7,80	4	000961991
1/8	101	24	10,7	7,80	4	000961992
9/64	112	29	18,7	8,50	4	000961993
5/32	112	29	18,7	8,50	4	000961994
3/16	131	33	31,5	11,30	2	000961995
7/32	154	36	50,0	11,70	2	000961996
1/4	164	40	70,0	12,50	2	000961997
5/16	175	44	115,0	14,70	2	000961998
3/8	197	51	186,5	18,30	2	000961999



96BPINOX-AS/B8	87,50	1	000962000
5/64-3/32-1/8-5/32-3/16-7/32-1/4-5/16			
96BPINOX/BV	6,80	1	000961459

96TINOX

chave sextavada,
com punho de binário elevado,
em aço inox



mm	L mm	L1 mm	€	🔧	📦
2,5	153	55	13,50	2	000961935
3	153	55	14,00	2	000961936
4	179	70	15,40	2	000961938
5	200	84	17,00	2	000961940
6	221	95	18,60	2	000961941
7	236	106	21,40	2	000961942
8	255	117	25,50	2	000961943
10	285	132	32,50	2	000961944



96TINOX/S5 2,5-3-4-5-6 mm	€ 78,50	🔧 1	📦 000961952
96TINOX/S8 2,5-3-4-5-6-7-8-10 mm	€ 158,00	🔧 1	📦 000961954

96TINOX-AS

chaves sextavadas,
com punhos de elevado aperto,
em aço inoxidável



"	L mm	L1 mm	Ø mm	€	🔧	📦
3/32	153	55	3	14,70	2	000961861
7/64	153	55	4	15,00	2	000961862
1/8	179	70	4	16,90	2	000961863
9/64	179	70	5	17,20	2	000961864
5/32	200	84	6	18,10	2	000961865
3/16	200	84	6	19,50	2	000961866
7/32	221	103	7	22,70	2	000961867
1/4	236	106	8	23,70	2	000961868
5/16	255	117	10	29,00	2	000961869
3/8	285	132	12	31,50	2	000961870



96TINOX-AS/S7 3/32-1/8-5/32-3/16-7/32-1/4-5/16	€ 145,00	🔧 1	📦 000961877
---	----------	-----	-------------

111INOX

Chaves ajustáveis, em aço inox



DIN 3117 - ISO 6787

L mm	L "	A max mm	A1 mm	€	🔧	📦
150	6	18	45	97,50	1	001110315
200	8	24	58	127,00	1	001110320
250	10	30	70	158,00	1	001110325

362INOX

chaves para tubos para trabalhos pesados,
aço inox



L mm	Ø max mm	€	🔧	📦
300	58	213,00	1	003620430

920INOX-A

Chaves de caixa sextavadas, em aço inox



DIN 3124 - UNI ISO 2725

🔧	Ø mm	A mm	L mm	€	🔧	📦
8	15	10	40	33,50	2	009203008
9	16	10	40	35,50	2	009203009
10	17	10	40	37,50	2	009203010
11	18	11	40	40,00	2	009203011
12	19	11	40	42,50	2	009203012
13	20	11	40	45,00	2	009203013
14	21	11	40	47,00	2	009203014
15	23	11	40	49,50	2	009203015
16	24	11	40	52,00	2	009203016
17	25	11	40	53,50	2	009203017
18	26	13	42	55,50	2	009203018
19	28	13	42	57,50	2	009203019
20	29	13	42	61,50	1	009203020
21	30	13	43	62,50	1	009203021
22	31	15	43	63,00	1	009203022
24	34	15	43	73,00	1	009203024
27	38	18	46	89,50	1	009203027
30	42	20	46	107,00	1	009203030
32	44	20	46	120,00	1	009203032

920/55INOX

Roquete reversível quadra 1/2", 72 dentes, em
aço inox



L mm	Ø mm	A mm	€	🔧	📦
264	40	43	259,00	1	009203882

920/R55INOX



920/R55 INOX	€	🔧	📦
	92,00	1	009203879

1048INOX

Alicate ajustável, de charneira fechada, em
aço inox

• Modelo de 7 posições

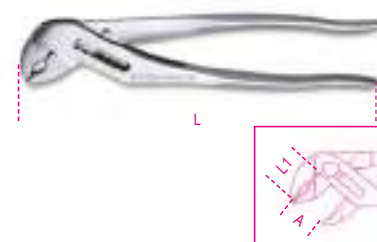

L mm	A max mm	L1 mm	€	🔧	📦
250	33	33	165,00	1	010480325

1082INOX

alicates de corte diagonal,
em aço inox



L mm	L1 mm	🔧	€	🔧	📦
150	20,0	1,6	120,00	1	010820350

1150INOX

alicates universais para trabalhos pesados,
em aço inox

pino descentralizado
junta aberta



L mm	L1 mm	€	🔧	📦
180	39	117,00	1	011500518



1153INOX

Alicates ajustáveis com duas posições, aço inox



L mm	L1 mm	€		
150	26	114,00	1	011530315

1290INOX

chaves para parafusos de perfil de fenda em aço inox

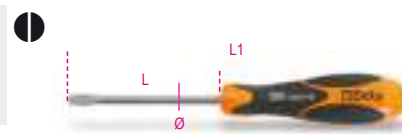

ISO 2380

SxAxL mm	L1 mm	Ø mm	€		
0,4x2,5x50	146	2.5	9,90	4	012900403
0,5x3x75	171	3.0	10,10	4	012900409
0,8x4x100	196	4.0	10,50	4	012900430
1,0x5,5x150	259	5.0	13,40	4	012900442
1,2x6,5x150	270	6.0	15,40	4	012900451

1292INOX

chaves para parafusos de perfil Phillips®, em aço inox

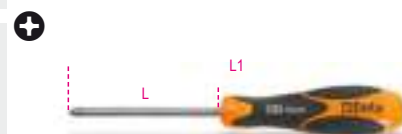

ISO 8764

PHxDxL mm	L1 mm	€		
0x3x60	156	9,20	4	012920403
1x4,5x80	189	10,90	4	012920409
2x6x100	220	13,40	4	012920418

1293INOX/D8

Jogo de 8 chaves de fendas em aço inox



1293INOX/D8	€		
1290INOX	93,00	1	012930408
1292INOX			

1370INOX

Martelo para mecânico tipo alemão, em aço inox



g	A mm	L mm	L1 mm	€		
500	25	240	101	103,00	1	013700375

1377INOX

martelos de bola, cabeça redonda, para trabalhos em cobre e latão, em aço inox



g	L mm	L1 mm	€		
230	220	82	60,00	1	013770623
340	220	90	86,50	1	013770634

1730INOX

espátula universal, em aço inox



A mm	L mm	€		
50	200	53,00	1	017300450

C20TSS

Caixa de ferramentas extensível com 5 divisões, em aço inox AISI 304



C20TSS	€		
	321,00	1	021203001

450x200x210 mm - 4kg

T23



T23	549
TV23	549

T99



T99	552
TV99	552

T228



T228	556
TV180	555-556

Beta

Beta

C04TSS-7

carro com sete gavetas, totalmente em aço inoxidável, rodas anti-marcas

Principais características:

- Sete gavetas (570 x 410 mm) com calhas assentes em rolamentos de esferas;
- 6 gavetas, 83 mm altura;
- 1 gaveta, 170 mm altura;
- 4 rodízios Ø 125 mm
- 2 fixos e 2 giratórios (dois com travão);
- Fechadura frontal centralizada;
- Estrutura totalmente fabricada em aço inoxidável
- Roletes, suportes, esferas, interiores de gavetas e calhas em aço inoxidável
- Pegas das gavetas em alumínio

63 kg

Beta
INOX
STAINLESS STEEL

700
kg

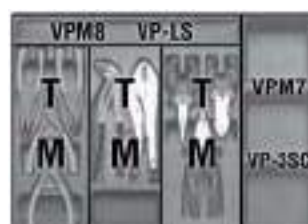

h	max
83 mm	25 kg
170 mm	30 kg

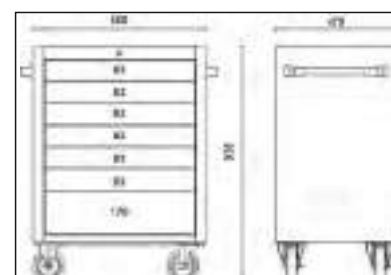
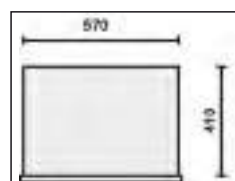

C04TSS/7

€ 2.870,00 1 024003077



COBRE-BERÍLIO Cu-Be

As ferramentas anti-faísca da **Beta** foram especialmente concebidas para operar com segurança em atmosferas potencialmente explosivas, na presença de líquidos ou gases inflamáveis, ou para aplicações que requerem ferramentas não magnéticas e resistentes à corrosão.

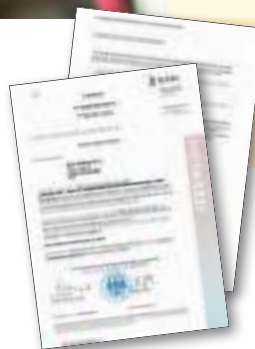

As ferramentas antifaiscantes da Beta são certificadas pelo Federal Institute for Materials Research and Testing, BAM, sob diretiva Europeia 99/92/EC



AVISO!

Risco de explosão em ambientes expostos a **ACETILENO**

As características mecânicas das ferramentas anti-faísca diferem das características das ferramentas em aço normais.

As ferramentas anti-faísca devem ser utilizadas com extrema precaução, evitando sobrecargas.

CLASSIFICAÇÃO DE ATMOSFERAS POTENCIALMENTE EXPLOSIVAS

ATEX	MÉDIO-BAIXO	EXTREMAMENTE BAIXO
GASES	ZONA 1 Área onde é provável, em condições normais de funcionamento, a formação ocasional de uma atmosfera explosiva constituída por uma mistura de ar com substâncias inflamáveis, sob a forma de gás, vapor ou névoa.	ZONA 2 Área onde não é provável, em condições normais de funcionamento, a formação de uma atmosfera explosiva constituída por uma mistura de ar com substâncias inflamáveis, sob a forma de gás, vapor ou névoa, ou onde essa formação, caso se verifique, seja de curta duração.
	ZONA 21 Área onde é provável, em condições normais de funcionamento, a formação ocasional de uma atmosfera explosiva sob a forma de uma nuvem de poeira combustível.	ZONA 22 Área onde não é provável, em condições normais de funcionamento, a formação de uma atmosfera explosiva sob a forma de uma nuvem de poeira combustível, ou onde essa formação, caso se verifique, seja de curta duração.

30BA

punção anti-faísca



Ø mm	L mm	S mm	€	U	U
5	150	15	68,50	1	000300806
8	150	17	84,50	1	000300808
10	150	19	105,00	1	000300810

31BA

punção anti-faísca



Ø mm	L mm	€	U	U
3	110	29,50	1	000310853
4	110	64,50	1	000310854
6	115	98,00	1	000310856
8	120	111,00	1	000310858

31BA/C

Punção cónico antifaísca



Ø mm	Ø1 mm	L mm	€	U	U
★6	12	150	40,00	1	000310876
★7	13	150	47,00	1	000310877
★12	18	175	101,00	1	000310882
★13	29	255	315,00	1	000310883

32BA

punções anti-faísca



Ø mm	L mm	€	U	U
14	150	94,50	1	000320811

34BA

escopro plano anti-faísca



L mm	A mm	€	U	U
200	22	128,00	1	000340801
250	24	214,00	1	000340803
300	25	288,00	1	000340802

39BA

cunha anti-faísca



L mm	A mm	€		
150	40	56,00	1	000390801
230	40	188,00	1	000390802
250	40	294,00	1	000390803

42BA

chave boca-luneta bi-sextavada anti-faísca



mm	L mm	€		
6x6	105	59,50	1	000420806
7x7	105	67,50	1	000420807
8x8	120	75,00	1	000420808
9x9	120	86,00	1	000420809
10x10	135	93,00	1	000420810
11x11	135	98,00	1	000420811
12x12	150	108,00	1	000420812
13x13	150	111,00	1	000420813
14x14	175	116,00	1	000420814
15x15	175	123,00	1	000420815
16x16	195	127,00	1	000420816
17x17	200	133,00	1	000420817
18x18	215	149,00	1	000420818
19x19	220	153,00	1	000420819
20x20	230	159,00	1	000420820
21x21	240	169,00	1	000420821
22x22	250	179,00	1	000420822
24x24	268	208,00	1	000420824
26x26	290	251,00	1	000420826
27x27	290	280,00	1	000420827
28x28	290	328,00	1	000420828
30x30	313	336,00	1	000420830
32x32	333	369,00	1	000420832
34x34	360	402,00	1	000420834
35x35	360	456,00	1	000420835
36x36	355	475,00	1	000420836
38x38	430	505,00	1	000420838
41x41	430	590,00	1	000420841
46x46	480	690,00	1	000420846
50x50	520	730,00	1	000420850
55x55	560	805,00	1	000420855
60x60	580	860,00	1	000420860
*65x65	595	980,00	1	000420865
*70x70	630	1.100,00	1	000420870

42BA-AS

chave boca-luneta bi-sextavada anti-faísca



mm	L mm	€		
9/32x9/32	120	64,50	1	000420946
5/16x5/16	120	64,50	1	000420947
11/32x11/32	135	82,00	1	000420948
3/8x3/8	128	86,00	1	000420950
7/16x7/16	135	98,00	1	000420951

mm	L mm	€		
15/32x15/32	140	108,00	1	000420949
1/2x1/2	140	112,00	1	000420953
9/16x9/16	163	122,00	1	000420954
*19/32x19/32	195	146,00	1	000420955
5/8x5/8	177	147,00	1	000420956
11/16x11/16	195	157,00	1	000420957
3/4x3/4	215	161,00	1	000420959
13/16x13/16	230	188,00	1	000420961
7/8x7/8	235	195,00	1	000420962
15/16x15/16	256	217,00	1	000420964
*31/32x31/32	265	238,00	1	000420963
1x1	266	235,00	1	000420965
1.1/16x1.1/16	283	264,00	1	000420967
1.1/8x1.1/8	297	348,00	1	000420969
1.3/16x1.3/16	308	376,00	1	000420970
1.1/4x1.1/4	324	442,00	1	000420973
*1.7/16x1.7/16	360	540,00	1	000420976

55BA

chave de bocas anti-faísca



mm	L mm	€		
6x7	90	41,00	1	000550801
8x9	100	44,00	1	000550802
8x10	100	45,50	1	000550795
9x11	110	48,50	1	000550797
10x11	120	52,00	1	000550803
12x13	130	65,50	1	000550804
*12x14	130	79,50	1	000550846
13x14	133	79,00	1	000550799
14x15	145	79,50	1	000550805
14x17	150	84,50	1	000550806
16x17	165	85,50	1	000550807
17x19	170	112,00	1	000550847
18x19	170	115,00	1	000550809
*19x22	185	131,00	1	000550810
20x22	185	132,00	1	000550811
21x23	210	144,00	1	000550813
22x24	210	171,00	1	000550815
24x26	230	201,00	1	000550817
24x27	230	214,00	1	000550818
25x28	230	232,00	1	000550819
27x29	246	271,00	1	000550820
30x32	265	317,00	1	000550822
36x38	320	402,00	1	000550826
36x41	335	442,00	1	000550828
41x46	355	550,00	1	000550829
*46x50	370	630,00	1	000550830
*50x55	385	670,00	1	000550831
*55x60	415	835,00	1	000550832

55BA-AS

chave de bocas anti-faísca



mm	L mm	€		
3/8x7/16	110	54,00	1	000550853
1/2x9/16	130	64,50	1	000550854
5/8x11/16	160	94,50	1	000550857
3/4x13/16	180	116,00	1	000550859
7/8x15/16	210	164,00	1	000550865
1x1.1/16	230	221,00	1	000550868
1.1/8x1.3/16	245	288,00	1	000550870
1.1/4x1.5/16	255	341,00	1	000550872

58BA

chaves de bocas de pancada anti-faísca



mm	L mm	€		
17	125	110,00	1	000580817
19	125	114,00	1	000580819
22	135	115,00	1	000580822
24	150	129,00	1	000580824
27	165	158,00	1	000580827
30	180	199,00	1	000580830
32	190	232,00	1	000580832
*34	200	265,00	1	000580834
36	210	275,00	1	000580836
38	220	303,00	1	000580838
41	230	341,00	1	000580841
46	240	408,00	1	000580846
50	255	463,00	1	000580850
*55	305	580,00	1	000580855
*60	315	670,00	1	000580860
*65	335	780,00	1	000580865
*70	370	940,00	1	000580870
*75	375	1.090,00	1	000580875
*80	400	1.300,00	1	000580880
*85	400	1.530,00	1	000580885
*90	445	1.820,00	1	000580890
*95	445	2.100,00	1	000580895
*100	485	2.440,00	1	000580900
*110	513	3.010,00	1	000580901

58BA-AS

chaves de bocas de pancada anti-faísca



mm	L mm	A mm	S mm	€		
*11/16	125	40,5	11,0	122,00	1	000580904
*3/4	125	40,5	11,0	124,00	1	000580905
*7/8	135	46,2	12,0	127,00	1	000580906
*15/16	150	50,3	12,0	145,00	1	000580907
*31/32	150	50,3	12,0	162,00	1	000580954
*1	175	56,9	15,0	168,00	1	000580908
*1.1/8	190	64,0	15,5	216,00	1	000580909
*1.1/4	190	64,0	15,5	253,00	1	000580910
*1.7/16	210	75,0	18,5	294,00	1	000580912
*1.1/2	220	82,0	18,5	349,00	1	000580913
*1.5/8	230	86,8	18,5	376,00	1	000580914
*1.3/4	250	98,0	20,	475,00	1	000580970

78BA

chave de luneta de pancada bi-sextavada anti-faísca



mm	L mm	€		
17	145	115,00	1	000780817
19	145	126,00	1	000780819
22	165	128,00	1	000780822
24	140	157,00	1	000780824
27	155	179,00	1	000780827
30	165	208,00	1	000780830
32	180	225,00	1	000780832
34	192	248,00	1	000780834
36	208	275,00	1	000780836
38	215	322,00	1	000780838
41	225	382,00	1	000780841
46	245	428,00	1	000780846
50	250	496,00	1	000780850

Ø mm	L mm	€	U	U
55	265	580,00	1	000780855
60	275	625,00	1	000780860
65	295	670,00	1	000780865
70	310	760,00	1	000780870
75	325	855,00	1	000780875
80	340	915,00	1	000780880
*85	355	1.160,00	1	000780885
*90	380	1.370,00	1	000780890
*95	390	1.580,00	1	000780895
*100	410	1.800,00	1	000780900
*105	420	2.000,00	1	000780903
*110	445	2.280,00	1	000780901
*120	480	2.690,00	1	000780902

78BA-AS

chave de luneta de pancada bi-sextavada anti-faísca



Ø mm	L mm	€	U	U
11/16	145	114,00	1	000780908
3/4	145	118,00	1	000780909
7/8	155	132,00	1	000780935
15/16	165	146,00	1	000780936
*31/32	165	170,00	1	000780937
1	175	170,00	1	000780938
*1.1/16	175	202,00	1	000780939
1.1/8	180	204,00	1	000780940
1.3/16	185	212,00	1	000780941
1.1/4	177	231,00	1	000780910
*1.5/16	200	235,00	1	000780954
*1.3/8	205	246,00	1	000780911
1.7/16	208	306,00	1	000780912
*1.1/2	215	319,00	1	000780913
*1.9/16	225	396,00	1	000780947
*1.11/16	225	417,00	1	000780962
1.5/8	225	387,00	1	000780914
*1.3/4	235	428,00	1	000780963
1.13/16	243	442,00	1	000780916
1.7/8	235	505,00	1	000780915
2	254	525,00	1	000780918
2.3/16	264	610,00	1	000780920
2.3/8	275	665,00	1	000780922
*2.9/16	286	690,00	1	000780924
*2.15/16	311	840,00	1	000780926
*3.1/8	325	975,00	1	000780928
*3.1/2	355	1.230,00	1	000780930

89BA

chave de luneta simples anti-faísca



Ø mm	L mm	€	U	U
10	200	130,00	1	000890810
11	210	135,00	1	000890811
12	220	140,00	1	000890812
13	230	144,00	1	000890813
14	240	146,00	1	000890814
16	260	157,00	1	000890816
17	270	162,00	1	000890817
18	280	175,00	1	000890818
19	300	180,00	1	000890819
20	310	225,00	1	000890820
22	330	225,00	1	000890822
24	350	247,00	1	000890824
27	370	305,00	1	000890827
30	400	341,00	1	000890830
32	420	358,00	1	000890832

90BA

chave de luneta anti-faísca



Ø mm	L mm	€	U	U
6x7	122	41,50	1	000900801
8x9	128	54,00	1	000900802
10x11	155	61,00	1	000900803
12x13	175	71,00	1	000900806
12X14	180	76,50	1	000900807
14x15	200	85,50	1	000900808
14x17	220	87,00	1	000900809
16x17	230	103,00	1	000900811
16x18	235	103,00	1	000900812
17X19	250	106,00	1	000900814
18x19	265	116,00	1	000900815
19x22	280	123,00	1	000900817
20x22	295	139,00	1	000900818
21x23	298	147,00	1	000900820
22x24	315	177,00	1	000900821
24x26	333	228,00	1	000900822
24x27	340	228,00	1	000900823
30x32	395	336,00	1	000900824
34x36	410	475,00	1	000900826
*36x41	450	645,00	1	000900828
*41x46	470	790,00	1	000900829
*46x50	490	880,00	1	000900830

91BA

chave de luneta anti-faísca para trabalhos pesados



Ø mm	Ø mm	€	U	U
24	38	275,00	1	000910824
27	42	328,00	1	000910827
30	48	376,00	1	000910830
32	49	419,00	1	000910832
36	54	456,00	1	000910836
41	62	510,00	1	000910841
*46	69	680,00	1	000910846
*50	75	725,00	1	000910850
*55	82	840,00	1	000910855

92BA

tubo anti-faísca para ref. 91BA



	L mm	91BA mm	Ø mm	€	U	U
92BA/1	460	24÷30	25	325,00	1	000920810
92BA/2	610	32÷41	28	419,00	1	000920820
*92BA/3	760	46÷55	32	565,00	1	000920830

93BA

chave de lunetas para parafusos para andaimes, anti-faísca



Ø mm	L mm	€	U	U
21x22	345	680,00	1	000930821

95BA

chave de lunetas direitas, anti-faísca



Ø mm	L mm	€	U	U
7x9	115	41,00	1	000950801
8x10	115	45,50	1	000950802
10x11	140	50,50	1	000950804
10x12	140	59,50	1	000950805
12x14	145	68,50	1	000950806
14x17	165	82,00	1	000950807
*16x18	170	107,00	1	000950809
*17x19	185	93,00	1	000950808
*18x19	185	116,00	1	000950810
*19x22	200	145,00	1	000950812
*21x23	230	160,00	1	000950815
*24x27	255	204,00	1	000950817
*30x32	295	306,00	1	000950820

96BA

chave sextavada anti-faísca



mm	L mm	L1 mm	€	U	U
1,5	50	17	84,50	1	000960760
2	50	16	86,00	1	000960762
2,5	56	20	92,50	1	000960761
3	63	21	94,00	1	000960763
4	69	25	99,00	1	000960764
5	78	29	103,00	1	000960765
6	88	33	105,00	1	000960766
7	93	34	110,00	1	000960767
8	97	36	116,00	1	000960768
9	104	37	122,00	1	000960769
10	110	39	126,00	1	000960770
11	118	42	134,00	1	000960771
12	122	44	153,00	1	000960772
14	150	58	171,00	1	000960774
15	156	60	180,00	1	000960775
16	162	63	199,00	1	000960776
17	168	65	208,00	1	000960777
19	177	72	233,00	1	000960779
22	186	77	273,00	1	000960802
24	192	82	315,00	1	000960804

96BA/BP

chave sextavada ponta de bola, anti-faísca



Ø mm	L mm	L1 mm	€	U	U
1,5	50	16	86,50	1	000961800
2	50	16	87,00	1	000961801
2,5	63	20	98,50	1	000961802
3	60	20	99,00	1	000961803
3,5	70	25	103,00	1	000961799
4	66	25	104,00	1	000961804
5	75	28	106,00	1	000961805
6	84	32	109,00	1	000961806
8	92	36	119,00	1	000961808
10	102	40	128,00	1	000961810
12	113	45	158,00	1	000961812

96BAF-AS

chaves sextavadas antifaísca



mm	L mm	L1 mm	€	U	PC
*1/16	59	25	68,50	1	000962831
*5/64	59	25	70,50	1	000962832
*3/32	59	25	73,50	1	000962833
*7/64	59	25	77,00	1	000962834
*1/8	59	25	80,00	1	000962835
*9/64	64	29	86,00	1	000962836
*5/32	65	30	88,50	1	000962837
*3/16	79	31	94,00	1	000962838
*7/32	85	37	98,00	1	000962839
*1/4	85	37	103,00	1	000962840
9/32	88	38	106,00	1	000962841
*5/16	92	44	111,00	1	000962842
11/32	100	44	114,00	1	000962843
*3/8	110	45	120,00	1	000962844
*7/16	119	48	128,00	1	000962845
*1/2	140	55	157,00	1	000962846
*9/16	150	58	179,00	1	000962847

99BA

chave de gancho anti-faísca, para porcas ranhuradas UNI/ISO 2982, 2983



mm	A mm	€	U	PC
32-75	4,0	222,00	1	000990803
50-120	4,5	349,00	1	000990805
115-170	4,5	565,00	1	000990811

110BA

chave ajustável anti-faísca



L mm	A max	€	U	PC
100	13	165,00	1	001100810
150	18	189,00	1	001100815
200	24	222,00	1	001100820
250	30	268,00	1	001100825
300	36	377,00	1	001100830
375	46	510,00	1	001100837
*450	55	710,00	1	001100845
*600	65	1.190,00	1	001100860

330BA

corta tubos anti-faísca para tubos de gás



330BA/2	Ø max 50 mm 2°	L mm 375	€	U	PC
			865,00	1	003300802

330BA/2R

canivete e canivete de substituição para corta-tubos anti-faísca 330BA para tubos de gás



330BA /2-R	€	U	PC
	87,00	1	003300822

363BA

chave para tubos anti-faísca para trabalhos pesados



L mm	Ø max	Ø max mm	€	U	PC
150	1/2" gas	20	281,00	1	003630815
200	1" gas	30	282,00	1	003630820
250	1"1/2 gas	49	328,00	1	003630825
300	2" gas	60	417,00	1	003630830
350	2" gas	60	520,00	1	003630835
450	2"1/2 gas	76	785,00	1	003630845
600	3" gas	90	1.100,00	1	003630860

378BA

chave de tubos anti-faísca, modelo sueco, em liga de cobre-berílio



L mm	Ø max "	€	U	PC
430	1" 1/2 gas	855,00	1	003780800
530	2" gas	1.060,00	1	003780801

386BA

chave de corrente para tubos anti-faísca reversível, para trabalhos pesados



L mm	Ø max mm	L1 mm	€	U	PC
600	100	470	1.290,00	1	003860806
900	200	750	2.140,00	1	003860809

911BA

chave de caixa bisextavada anti-faísca



mm	L mm	€	U	PC
6	28	57,00	1	009110806
7	28	61,00	1	009110807
8	28	65,50	1	009110808
9	28	69,50	1	009110809
10	32	94,50	1	009110810
11	32	99,50	1	009110811
12	32	105,00	1	009110812
13	32	110,00	1	009110813
14	32	117,00	1	009110814
15	32	118,00	1	009110815
16	32	124,00	1	009110816
17	32	128,00	1	009110817
18	32	130,00	1	009110818
19	32 32	135,00	1	009110819

911BA/16

adaptador, quadras fêmea 3/8" e macho 1/2", anti-faísca



L mm	3/8"	1/2"	€	U	PC
34			120,00	1	009110836

911BA/20

Extensão com quadras macho e fêmea de 1/2", anti-faísca



L mm	€	U	PC
75	97,00	1	009110840

911BA/55

roquete anti-faísca, quadra 3/8"



L mm	D mm	A mm	€	U	PC
200	45	16.5	206,00	1	009110882



921BA

chave de caixa bisextavada anti-faísca



mm	Ø mm	L mm	€	1	009210808
8	15,0	40	85,50	1	009210808
9	16,0	40	90,00	1	009210809
10	17,5	40	103,00	1	009210810
11	18,0	40	107,00	1	009210811
12	18,5	40	114,00	1	009210812
13	20,0	40	120,00	1	009210813
14	21,0	40	123,00	1	009210814
15	21,5	40	127,00	1	009210815
16	24,0	40	131,00	1	009210816
17	25,0	40	136,00	1	009210817
18	25,0	40	142,00	1	009210818
19	28,0	42	146,00	1	009210819
20	29,0	42	153,00	1	009210820
21	30,0	43	156,00	1	009210821
22	30,5	43	162,00	1	009210822
24	34,0	43	190,00	1	009210824
25	36,0	43	206,00	1	009210825
26	37,5	43	220,00	1	009210826
27	37,5	45	231,00	1	009210827
28	38,9	46	241,00	1	009210828
30	41,5	46	271,00	1	009210830
32	43,5	46	299,00	1	009210832

921BA-AS

Chave de caixa bisextavada anti-faísca



"	Ø mm	L mm	€	1	009210958
5/16	24,0	40	91,50	1	009210958
3/8	24,0	40	98,50	1	009210960
7/16	24,0	40	108,00	1	009210961
1/2	24,0	40	115,00	1	009210963
9/16	24,0	40	120,00	1	009210964
5/8	25,0	40	136,00	1	009210966
11/16	25,5	40	147,00	1	009210967
3/4	28,0	42	162,00	1	009210969
13/16	30,0	43	171,00	1	009210971
7/8	31,5	43	187,00	1	009210972
15/16	34,0	43	198,00	1	009210974
1	36,0	43	220,00	1	009210975
1.1/16	38,0	46	237,00	1	009210977
1.1/4	42,0	46	315,00	1	009210982
1.7/16	50,5	50	387,00	1	009210986

921BA/15

adaptador, quadras fêmea 1/2" e macho 3/8", anti-faísca



L mm	1/2"	3/8"	€	1	009210839
34	1/2"	3/8"	109,00	1	009210839

921BA/16

adaptador, encabadoiro 1/2" fêmea e 3/4" macho, antifaísca



L mm	1/2"	3/4"	€	1	009210840
34	1/2"	3/4"	143,00	1	009210840

921BA/21 - 921BA/22

extensão anti-faísca com encabadoiro 1/2"



	L mm	Ø mm	€	1	009210842
921BA/21	125	30	145,00	1	009210842
921BA/22	250	31	202,00	1	009210844

921BA/25

cardan anti-faísca com quadras macho e fêmea de 1/2"



L mm	Ø mm	1/2"	1/2"	€	1	009210845
80	25	1/2"	1/2"	147,00	1	009210845

921BA/42

punho em T anti-faísca encabadoiro 1/2"



L mm	€	1	009210846
250	238,00	1	009210846

921BA/50

roquete anti-faísca encabadoiro quadrado 1/2"



L mm	D mm	A mm	€	1	009210850
250	45	16,5	275,00	1	009210850

921BA/R50

quadra de substituição para roquete anti-faísca



1/2"	€	1	009210851
1/2"	82,00	1	009210851

926BA

chave de caixa anti-faísca bi-sextavada



mm	Ø mm	L mm	€	1	009260822
22	40	55	179,00	1	009260822
24	40	55	201,00	1	009260824
26	40	55	228,00	1	009260826
27	40	55	241,00	1	009260827
28	41	55	282,00	1	009260828
30	43	60	288,00	1	009260830
32	45	60	322,00	1	009260832
34	48	60	342,00	1	009260834
36	50	60	371,00	1	009260836
38	53	60	396,00	1	009260838
41	57	65	434,00	1	009260841
46	63	65	520,00	1	009260846
50	68	70	565,00	1	009260850

926BA/15

adaptador, encabadoiro 3/4" fêmea e 1/2" macho, antifaísca



L mm	3/4"	1/2"	€	1	009260861
55	3/4"	1/2"	143,00	1	009260861

926BA/22

extensão anti-faísca com encabadoiro 3/4"



926BA/22	L mm	Ø mm	€	1	009260872
926BA/22	200	38	288,00	1	009260872

926BA/42

punho em T anti-faísca encabadoiro 3/4"



L mm	€	1	009260876
400	417,00	1	009260876

926BA/50

roquete reversível anti-faísca encabadouro 3/4"



L mm	D mm	A mm	€	🔧	📄
300	61	22	428,00	1	009260880

926BA/R50

quadra de substituição para roquete anti-faísca



3/4"	€	🔧	📄
	136,00	1	009260881

937BA

chave de cachimbo sextavada, anti-faísca



Ø mm	L mm	A mm	€	🔧	📄
13	240	45	107,00	1	009370813
17	260	51	154,00	1	009370817
19	270	55	161,00	1	009370819
22	278	59	211,00	1	009370822
24	286	63	225,00	1	009370824
27	294	69	239,00	1	009370827
30	302	75	264,00	1	009370830
32	310	81	288,00	1	009370832
*36	330	85	339,00	1	009370836
*41	350	90	409,00	1	009370841

951BA

Chaves sextavadas macho com punho em T, antifaísca



mm	L mm	L1 mm	€	🔧	📄
4	100	90	179,00	1	009510904
5	100	90	188,00	1	009510905
6	100	90	199,00	1	009510906

961BA

Alavanca anti-faísca



L mm	A mm	€	🔧	📄
250	39	158,00	1	009610802
350	55	238,00	1	009610806

963BA

alavancas anti-faísca com uma extremidade aguçada e outra plana



L mm	A mm	€	🔧	📄
500	24	441,00	1	009630801
*800	24	695,00	1	009630803
*1000	30	1.470,00	1	009630805

964BA

chave para tampões anti-faísca



L mm	€	🔧	📄
385	417,00	1	009640801

964BA/L

chave universal para tampões; anti-faísca

Para abrir tampões em metal



*964BA/L	L mm	€	🔧	📄
	510	2.110,00	1	009640821

965BA

chave para válvulas de segurança, anti-faísca



A mm	A1 mm	L mm	€	🔧	📄
30	44	200	183,00	1	009650830
32	50	300	255,00	1	009650832
35	47	250	208,00	1	009650835
40	50	300	239,00	1	009650840
45	58	350	309,00	1	009650845
48	62	375	322,00	1	009650848
50	67	400	353,00	1	009650850

A mm	A1 mm	L mm	€	🔧	📄
55	73	450	422,00	1	009650855
60	79	500	456,00	1	009650860
*65	82	550	510,00	1	009650865
*70	85	600	565,00	1	009650870

966BA

chave de válvulas de segurança anti-faísca

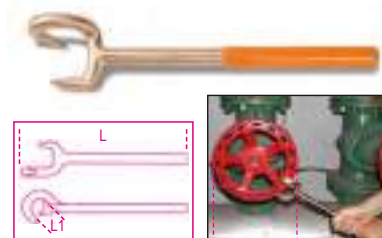

L mm	L1 mm	Ø min+max mm	€	🔧	📄
350	40	50÷150	400,00	1	009660801

966BA/V

chaves válvula de segurança anti-faísca

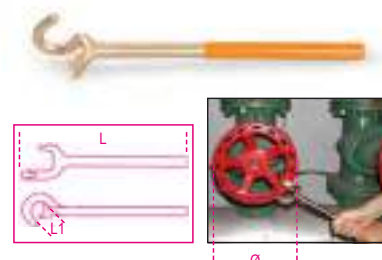

L mm	L1 mm	Ø min+max mm	€	🔧	📄
370	36	125÷250	400,00	1	009660812
430	48	250÷400	580,00	1	009660814

1032BA

alicate anti-faísca com circlip interno, plano, pegas revestimento em PVC



L mm	Ø mm	€	🔧	📄
200	40÷100	261,00	1	010320820

1036BA

alicate anti-faísca com circlip externo, plano, pegas revestimento em PVC



L mm	Ø mm	€	🔧	📄
200	40÷100	261,00	1	010360820

1046BA

alicate anti-faísca

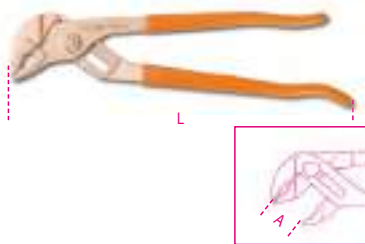

L mm	A max mm	€	🔧	📄
250	32	341,00	1	010460801
★300	52	449,00	1	010460803

1052BA

Alicate de pressão, maxilas côncavas, anti-faísca

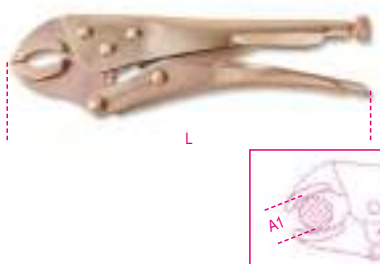

L mm	A1 max mm	€	🔧	📄
225	40,0	336,00	1	010520824

1082BA

alicate de corte diagonal anti-faísca



L mm	L1 mm	€	🔧	📄
160	22	244,00	1	010820801

1100BA

corta parafusos, anti-faísca



L mm	€	🔧	📄
600	1.750,00	1	011000860

1137BA

alicate de cravagem



L mm	L1 mm	€	🔧	📄
185	30	454,00	1	011370801

1137BA/RC

mordente sobresselente para ref. 1137BA



1137BA/RC	€	🔧	📄
	87,00	1	011370851

1150BA

alicate universal anti-faísca

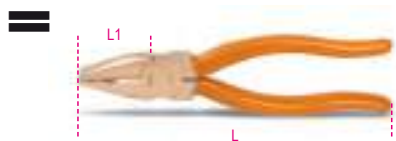

L mm	L1 mm	€	🔧	📄
200	40	287,00	1	011500820

1162BA

alicate de pontas planas extra-longas anti-faísca



L mm	L1 mm	€	🔧	📄
150	54	225,00	1	011620815

1166BA

alicate de pontas semi-redondas extra-longas anti-faísca



L mm	L1 mm	€	🔧	📄
150	54	225,00	1	011660815

1270BA

chave de fendas anti-faísca



AxL mm	L1 mm	€	🔧	📄
3x75	178	41,00	1	012700803
4x100	209	50,50	1	012700804
5x150	250	67,50	1	012700805
6x150	270	71,00	1	012700806
10x250	382	109,00	1	012700810
8x200	312	81,00	1	012700808

1272BA

chave de fendas anti-faísca para parafusos Phillips®

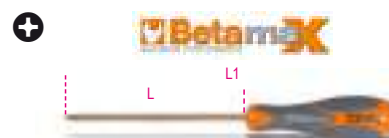

PHxDxL mm	L1 mm	€	🔧	📄
1x5x100	209	56,50	1	012720801
2x6x150	270	72,00	1	012720802
3x8x200	332	86,50	1	012720803

1277BA

chaves de fendas para parafusos de perfil Torx®, antifaísca



Ø	L mm	L1 mm	Ø mm	€	🔧	📄
T10	75	184	5	54,00	1	012770810
T15	75	184	5	58,00	1	012770815
T20	100	209	6	79,00	1	012770820
T25	125	209	6	83,00	1	012770825
T30	150	270	6	91,50	1	012770830
T40	200	332	8	122,00	1	012770840

1370BA

martelo para mecânico anti-faísca, cabo em madeira



g	A mm	L mm	L1 mm	€	🔧	📄
500	30	310	108	151,00	1	013700805
1000	35	340	137	265,00	1	013700810

1370BA/MR

cabo de substituição para ref. 1370BA

	€		
1370BA/MR 500	25,50	1	013700865
1370BA/500			
1370BA/MR 1000	31,00	1	013700870
1370BA/1000			

1370BA/PL

martelos para mecânico antifaísca,
cabo em fibra



g	A mm	L mm	L1 mm	€		
500	30	310	108	151,00	1	013700815
1000	35	340	137	265,00	1	013700820

1375BA/PL

martelo de orelhas anti-faísca,
cabo em fibra



g	L mm	L1 mm	Ø mm	€		
680	321	125	30	194,00	1	013750800

1377BA

martelo de bola anti-faísca, cabeça redonda,
para trabalhos em cobre e latão



g	L1 mm	L mm	€		
340	90	280	97,00	1	013770834

1377BA/PL

martelo de bola anti-faísca, cabeça redonda,
para trabalhos em cobre e latão



g	L1 mm	L mm	€		
340	90	280	97,00	1	013770884

1379BA

martelo picador anti-faísca,
cabo em madeira



g	L1 mm	L mm	€		
500	142	315	188,00	1	013790850

1380BA

maço anti-faísca,
cabo em madeira



g	L1 mm	L mm	€		
1000	100	400	325,00	1	013800810
1500	118	400	396,00	1	013800815
2000	126	400	525,00	1	013800820

1380BA/MR

cabo de substituição para ref. 1380BA

	€		
1380BA/MR 1000	33,00	1	013800860
1380BA/1000			
1380BA/MR 1500	33,00	1	013800865
1380BA/1500			
1380BA/MR 2000	33,00	1	013800870
1380BA/2000			

1380BA/PL

marretas antifaísca,
cabo em fibra



g	L1 mm	L mm	€		
500	80	310	162,00	1	013800955
1000	94	350	303,00	1	013800960
1500	115	400	434,00	1	013800965
2000	125,5	400	570,00	1	013800970

1381BA

martelos anti-faísca,
cabos em madeira



g	L1 mm	L mm	€		
5000	179	900	1.220,00	1	013810850
★8000	190	900	1.940,00	1	013810858

1381BA/MR

cabo de substituição para ref. 1381BA

	€		
1381BA/MR 5000	50,50	1	013810870
1381BA/5000			
★1381BA/MR 8000	58,50	1	013810878
1381BA/8000			

1381BA/PL

marretas antifaísca,
cabo em fibra



g	L1 mm	L mm	€		
5000	172	900	1.120,00	1	013810885
8000	204	900	2.000,00	1	013810888

1390BA

martelo anti-faísca com superfície de contacto
macia



Ø mm	L mm	L1 mm	€		
★52	370	130	261,00	1	013900805

1390BA/R

batentes sobresselentes em nylon para artigo
1390BA

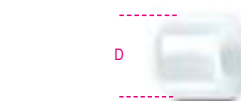

D mm	€		
52	53,00	4	013900885



1602BA

alicates para cravar terminais anti-faísca para terminais isolados, série ligeira



mm ²	L mm	€	U	PC
0.75÷6	200	321,00	1	016020801

1701BA

escopros sextavados anti-faísca



L mm	A mm	S mm	€	U	PC
150	12	10	59,00	1	017010810
200	16	14	94,50	1	017010814
250	18	14	116,00	1	017010815
350	19	17	306,00	1	017010817

1703BA/A

machado anti-faísca



L mm	L1 mm	A mm	€	U	PC
340	145	82	265,00	1	017030082

1703BA/P

picareta anti-faísca



A mm	L mm	L1 mm	€	U	PC
56	1050	410	695,00	1	017030150

1703BA/PL

pá anti-faísca



A mm	L1 mm	L mm	€	U	PC
240	420	990	585,00	1	017030200

1717BA

espátula rígida anti-faísca



A mm	€	U	PC
60	143,00	1	017170801
80	158,00	1	017170803

1717BA/1

raspador anti-faísca



A mm	L mm	€	U	PC
100	220	285,00	1	017170805

1719BA8

limas 8" anti-faísca



	L mm	€	U	PC
1719BA8/P	200	175,00	1	017190801
1719BA8/M	200	180,00	1	017190805
1719BA8/R	200	185,00	1	017190810
1719BA8/T	200	170,00	1	017190815
1719BA8/Q	200	170,00	1	017190820

1719BA12

limas 12" anti-faísca



L mm	€	U	PC	
1719BA12/P	300	315,00	1	017190831

1727BA

serrote e folha anti-faísca

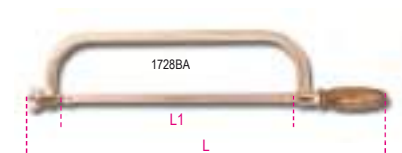

L mm	L1 mm	€	U	PC
500	300	560,00	1	017270801

1728BA

lâminas anti-faísca para serrotes, em liga de cobre-berílio



L mm	€	U	PC
300	108,00	1	017280801

1737BA

escova de arame anti-faísca



L mm	A mm	€	U	PC
294	29	72,00	1	017370801

1758BA

funil antifaísca



Ø mm	H mm	€	U	PC
160	150	101,00	1	017580815

1776BA

navalha anti-faísca



L1 mm	L mm	€	U	PC
145	250	157,00	1	017760801

1784BA

tesoura anti-faísca



L mm	€	U	PC
225	271,00	1	017840822





FERRAMENTAS ELÉTRICAS

Instrumentos de trabalho fiáveis e duradouros, capazes de satisfazer as exigências de cada profissional.

A família de ferramentas elétricas da Beta inclui

FERRAMENTAS A BATERIA

FERRAMENTAS COM FIO



FERRAMENTAS A BATERIA



A nova gama de ferramentas a bateria inclui máquinas de alto desempenho de 12V e 20V.

A **linha 12V** inclui a aparafusadora e a chave de impacto, ferramentas indispensáveis concebidas para facilitar o trabalho diário, baseadas em desempenho, leveza e dimensões compactas.

Já a **linha 20V** é composta por ferramentas a bateria, sinónimo de **alto desempenho, qualidade de construção e durabilidade**.

Na Beta confiamos nessas características para desenvolver uma linha abrangente de ferramentas a bateria, desde a aparafusadora de binário elevado até à chave de impacto com quadra de ½”.

Todas as novas ferramentas elétricas Beta estão equipadas com motores sem escovas e mecanismos interiores de qualidade, para melhorar significativamente o desempenho e a durabilidade da ferramenta.

A chave de impacto com um binário máximo de desaparafusamento de 1200 Nm é sem dúvida a principal ferramenta elétrica da nova linha, um parceiro de trabalho ideal para quem precisa de potência e desempenho incomparáveis.

As nossas baterias de íões de lítio de 20V estão disponíveis com capacidades até 6Ah e podem ser usadas em todas as ferramentas da linha.



Digitalize o código QR para mais informações sobre a extensão gratuita da garantia de 3 anos.

1972/K12V-10

aparafusadora ultracompacta, 12V

- ultracompacta: comprimento máximo de 170 mm; ultraleve: não mais de 1,1 kg, com bateria e perfeitamente equilibrada
- velocidade mecânica dupla com engrenagens de aço e embraiagem de 20 posições
- binário até 30 Nm e 1300 rpm (400 rpm na 1ª velocidade); fura diâmetros até 10 mm em aço e 20 mm em madeira
- Baterias de 2Ah e indicador de carga no corpo da máquina
- punho ergonómico antiderrapante
- LED frontal
- bucha automática de 10 mm
- clipe para cinto (lado direito/esquerdo)
- botão seletor, modos de aparafusar-desaparafusar-bloqueio (para transporte)
- fornecido em mala rígida com 2 baterias de íões de lítio (2 Ah) e carregador rápido (50 min)



CE

1972/K12V-10

€ 287,00 1 019720112

316x254x96 mm - 2,3 kg

1982/K12V

chave de impacto reversível, 12V,
ideal para trabalhos em áreas pequenas, com binário elevado (80 Nm), operação com uma mão

- ultracompacta: comprimento máximo de 160 mm; ultraleve: não mais de 1 kg, com bateria, e perfeitamente equilibrada
- encabadouro sextavado 1/4" com porca de bloqueio
- clipe para cinto (lado direito/esquerdo)
- LED frontal
- botão seletor, modos de aparafusar-desaparafusar-bloqueio (para transporte)
- punho ergonómico antiderrapante
- caixa de engrenagens inteiramente em metal
- baterias 2Ah com indicador de carga no corpo da máquina
- fornecido em mala rígida com 2 baterias de íões de lítio (2 Ah) e carregador rápido (50 min)



CE

1982/K12V

€ 287,00 1 019820112

316x254x96 mm - 2,3 kg

1972/K12V-COMBO

kit aparafusadora 12V ultracompacta + chave de impacto reversível encabadouro sextavado 1/4"

Inclui:

- 1 aparafusadora ultracompacta 12V, com bucha automática de 10 mm
- 1 chave de impacto reversível 12V, com encabadouro sextavado 1/4"
- 2 baterias de íões de lítio 2Ah
- 1 carregador rápido



CE

1972/K12V-COMBO

€ 488,00 1 019720010

310x295x100 mm - 3 kg

1972/12V-10

aparafusadora ultracompacta, 12V (sem baterias e sem carregador)

- Ultracompacta - comprimento máximo de 170 mm; ultraleve - não mais de 1.1 kg, com bateria e perfeitamente equilibrada
- Bucha automática de 10 mm
- Binário até 30 Nm e 1300 rpm (400 rpm na 1ª velocidade); fura diâmetros até 10 mm em aço e 20 mm em madeira
- Velocidade mecânica dupla com engrenagens em aço (0-400/1300 rpm)
- Embraiagem de 20 posições
- Botão seletor, modos de aparafusar-desaparafusar-bloqueio (para transporte)
- LED frontal
- Punho ergonômico antiderrapante
- Clipe para cinto (lado esquerdo/direito)

📏 790 g

1972/12V-10

€ 119,00 1 019720113



1982/12V

chave de impacto reversível, 12V (sem baterias e sem carregador)

Ideal para trabalhos em áreas reduzidas, binário elevado (80 Nm); operação com uma mão

- ultracompacta - comprimento máximo de 160 mm; ultraleve - não mais de 1 kg, com bateria e perfeitamente equilibrada
- encabadouro sextavado 1/4", com porca de bloqueio
- clipe para cinto (lado direito/esquerdo)
- LED frontal
- botão seletor, modos de aparafusar-desaparafusar-bloqueio (para transporte)
- punho ergonômico antiderrapante
- caixa de engrenagens inteiramente em metal

📏 800 g

1982/12V

€ 127,00 1 019820113



1994BL 12V-2AH

bateria de íons de lítio 2Ah, 12V

Características principais

- Voltagem da bateria: 12V
- Capacidade da bateria: 2Ah
- Capacidade energética: 24Wh
- Tipo de bateria: Li-ion

📏 170 g

1994BL 12V-2AH

€ 53,50 1 019940015



1994CB 12V

carregador rápido, 12V, 110V-240V

Características principais:

- Indicador LED de nível de carga
- Voltagem nominal de entrada: 110V-240V ~ 50/60Hz
- Voltagem de saída: 12.6V
- Corrente de carga: 2A
- Potência nominal de entrada: 35W
- Tempo de carregamento da bateria 2Ah: 50 min

📏 260 g

1994CB 12V

€ 53,50 1 019940123



1972/K20V-13BMC

kit berbequim de percussão, 20V, BRUSHLESS

CE

• Motor brushless

Desempenho significativamente melhorado: maior potência, redução do consumo de energia, vida útil prolongada do motor, fornecimento de energia melhorado do botão

- 3 modos de funcionamento: furar, aparafusar e furar com percussão
- Compacto: comprimento máximo de 210 mm
- Punho ergonómico antiderrapante
- Botão seletor, modos de aparafusar-desaparafusar-bloqueio (para transporte)
- Caixa de engrenagens inteiramente em metal
- Luz LED integrada para trabalhar em condições de pouca visibilidade
- Clipe para cinto (lado direito/esquerdo)
- Punho lateral adicional para trabalhos de binário elevado
- Fornecido em mala rígida com 2 baterias de íões de lítio (4 Ah) e carregador rápido

Características principais:

- Binário máx.: 80 Nm
- 20 posições de ajuste do binário
- Bucha automática de 13 mm
- Velocidade mecânica dupla com engrenagens em aço (0-450/1650 rpm)
- Diâmetro máx. de perfuração em madeira: 55 mm
- Diâmetro máx. de perfuração em metal: 13 mm
- Diâmetro máx. de perfuração em alvenaria: 13 mm

Beta
**3-YEAR
WARRANTY**

DISPONÍVEL
A PARTIR DE MAIO



1972/K20V-13BMC

€ 625,00 1 019720020

490x370x125 mm - 5,5 kg

1972/20V-13BMC

berbequim de percussão, 20V, BRUSHLESS (sem baterias e sem carregador)

CE

• Motor brushless

Desempenho significativamente melhorado: maior potência, redução do consumo de energia, vida útil prolongada do motor, fornecimento de energia melhorado do botão

- 3 modos de funcionamento: furar, aparafusar e furar com percussão
- Compacto: comprimento máximo de 210 mm
- Punho ergonómico antiderrapante
- Botão seletor, modos de aparafusar-desaparafusar-bloqueio (para transporte)
- Caixa de engrenagens inteiramente em metal
- Luz LED integrada para trabalhar em condições de pouca visibilidade
- Clipe para cinto (lado direito/esquerdo)
- Punho lateral adicional para trabalhos de binário elevado
- Fornecido em mala rígida, sem baterias e sem carregador

Características principais:

- Binário máx.: 80 Nm
- 20 posições de ajuste do binário
- Bucha automática de 13 mm
- Velocidade mecânica dupla com engrenagens em aço (0-450/1650 rpm)
- Diâmetro máx. de perfuração em madeira: 55 mm
- Diâmetro máx. de perfuração em metal: 13 mm
- Diâmetro máx. de perfuração em alvenaria: 13 mm

Beta
**3-YEAR
WARRANTY**

DISPONÍVEL
A PARTIR DE MAIO



1972/20V-13BMC

€ 257,00 1 019720019

490x370x125 mm - 3,6 kg

1984/K600

chave de impacto reversível, 20 V, sem escovas, encabadouro 1/2" - 600 Nm

- 3 ajustes de binário e rpm no modo de aparafusar
- Binário de desaperto até 600 Nm

• Motor BRUSHLESS

Desempenho significativamente melhorado: maior potência, redução do consumo de energia, vida útil prolongada do motor, fornecimento de energia melhorado do botão

- Encabadouro quadra 1/2" com anel de retenção
- Caixa de engrenagens inteiramente em metal
- Punho ergonómico antiderrapante
- Botão seletor, modos de aparafusar-desaparafusar-bloqueio (para transporte)
- Luz LED integrada para trabalhar em condições de pouca visibilidade
- Clipe para cinto (lado direito/esquerdo)

Aperto

3 ajustes de binário e rpm (baixo - médio - alto):

- 1: 200 Nm; 1000 rpm
- 2: 350 Nm; 1500 rpm
- 3: 550 Nm; 1800 rpm

Desaperto

- 1: 600 Nm: a chave de impacto aplica o binário máximo sem parar (desaperto livre)
- 2: 600 Nm - Autostop: a chave de impacto aplica o binário máximo até a porca estar totalmente desapertada e para automaticamente (desaperto por impacto único)

Fornecida em prático estojo rígido completo com 2 baterias de lítio ion (4 Ah) e carregador rápido.

DISPONÍVEL
A PARTIR DE MAIO

Beta
**3-YEAR
WARRANTY**



1984/K600

€ 720,00



1



019840060

490x370x125 mm - 6,3 kg

1984 20V/600BMC

chave de impacto reversível, 20V, BRUSHLESS, com encabadouro 1/2" - 600 Nm (sem baterias e sem carregador)

- 3 ajustes de binário e rpm no modo de aparafusar
- Binário de desaperto até 600 Nm

• Motor BRUSHLESS

Desempenho significativamente melhorado: maior potência, redução do consumo de energia, vida útil prolongada do motor, fornecimento de energia melhorado do botão

- Encabadouro quadra 1/2" com anel de retenção
- Caixa de engrenagens inteiramente em metal
- Punho ergonómico antiderrapante
- Botão seletor, modos de aparafusar-desaparafusar-bloqueio (para transporte)
- Luz LED integrada para trabalhar em condições de pouca visibilidade
- Clipe para cinto (lado direito/esquerdo)
- Fornecido em mala rígida, sem baterias e sem carregador

Aperto

3 ajustes de binário e rpm (baixo - médio - alto):

- 1: 200 Nm; 1000 rpm
- 2: 350 Nm; 1500 rpm
- 3: 550 Nm; 1800 rpm

Desaperto

- 1: 600 Nm: a chave de impacto aplica o binário máximo sem parar (desaperto livre)
- 2: 600 Nm - Autostop: a chave de impacto aplica o binário máximo até a porca estar totalmente desapertada e para automaticamente (desaperto por impacto único)

DISPONÍVEL
A PARTIR DE MAIO

Beta
**3-YEAR
WARRANTY**



1984 20V/600BMC

€ 351,00



1



019840907

490x370x125 mm - 4,4 kg

1984/K1200

chave de impacto reversível, 20 V, sem escovas, encabadouro 1/2" - 1200 Nm

CE

Ideal para aplicações que exigem binário elevado.

- 3 ajustes de binário e rpm no modo de aparafusar
- Binário de desaperto até 1200 Nm
- Binário máximo até 1700 Nm

• Motor BRUSHLESS

Desempenho significativamente melhorado: maior potência, redução do consumo de energia, vida útil prolongada do motor, fornecimento de energia melhorado do botão

- Encabadouro quadra 1/2" com anel de retenção
- Caixa de engrenagens inteiramente em metal
- Punho ergonómico antiderrapante
- Botão seletor, modos de aparafusar-desaparafusar-bloqueio (para transporte)
- Luz LED integrada para trabalhar em condições de pouca visibilidade
- Clipe para cinto (lado direito/esquerdo)

Aperto

3 ajustes de binário e rpm (baixo - médio - alto):

1: 350 Nm; 800 rpm

2: 600 Nm; 1400 rpm

3: 900 Nm; 1600 rpm

Desaperto

1: 1200 Nm: a chave de impacto aplica o binário máximo sem parar (desaperto livre)

2: 1200 Nm - Autostop: a chave de impacto aplica o binário máximo até a porca estar totalmente desapertada e para automaticamente (desaperto por impacto único)

Fornecida em prático estojo rígido completo com 2 baterias de lítio ion (6 Ah) e carregador rápido.

DISPONÍVEL
A PARTIR DE MAIO

Beta
3-YEAR
WARRANTY



1984/K1200

€ 870,00



1



019840120

490x370x125 mm - 7 kg

1984 20V/1200BMC

chave de impacto reversível, 20V, BRUSHLESS, com encabadouro 1/2" - 1200 Nm (sem baterias e sem carregador)

CE

Ideal para aplicações que exigem binário elevado.

- 3 ajustes de binário e rpm no modo de aparafusar
- Binário de desaperto até 1200 Nm
- Binário máximo até 1700 Nm

• Motor BRUSHLESS

Desempenho significativamente melhorado: maior potência, redução do consumo de energia, vida útil prolongada do motor, fornecimento de energia melhorado do botão

- Encabadouro quadra 1/2" com anel de retenção
- Caixa de engrenagens inteiramente em metal
- Punho ergonómico antiderrapante
- Botão seletor, modos de aparafusar-desaparafusar-bloqueio (para transporte)
- Luz LED integrada para trabalhar em condições de pouca visibilidade
- Clipe para cinto (lado direito/esquerdo)
- Fornecido em mala rígida, sem baterias e sem carregador

Aperto

3 ajustes de binário e rpm (baixo - médio - alto):

1: 350 Nm; 800 rpm

2: 600 Nm; 1400 rpm

3: 900 Nm; 1600 rpm

Desaperto

1: 1200 Nm: a chave de impacto aplica o binário máximo sem parar (desaperto livre)

2: 1200 Nm - Autostop: a chave de impacto aplica o binário máximo até a porca estar totalmente desapertada e para automaticamente (desaperto por impacto único)

DISPONÍVEL
A PARTIR DE MAIO

Beta
3-YEAR
WARRANTY

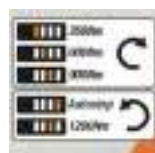

1984 20V/1200BMC

€ 409,00



1



019840911

490x370x125 mm - 4,7 kg

1986/K20V-125

kit rebarbadora, 20V, BRUSHLESS

Motor BRUSHLESS

Desempenho significativamente melhorado: maior potência, redução do consumo de energia, vida útil prolongada do motor, fornecimento de energia melhorado do botão

Características principais

- Proteção contra arranque involuntário
- Punho adicional que pode ser montado em ambos os lados
- Resguardo do disco sem ferramentas (libertação rápida)
- Dispositivo de bloqueio do veio para substituição rápida do disco
- Interruptor deslizante on/off
- Entradas de ar protegidas contra infiltração de poeiras, proporcionam um arrefecimento eficaz
- Fornecido em mala rígida, Fornecido em mala rígida com 2 baterias de íões de lítio (4 Ah) e carregador rápido

Características técnicas

- Diâmetro do disco (não incluído): 125/115 mm
- Rotações em vazio: 8.000 rpm
- Rosca do veio: M14
- Comprimento do cabo: 4 m

Beta
**3-YEAR
WARRANTY**

DISPONÍVEL
A PARTIR DE MAIO



CE

1986/K20V-125

€ 625,00



1



019860015

490x370x125 mm - 5,6 kg

1986/20V-125BMC

rebarbadora, 20V BRUSHLESS, (sem baterias e sem carregador)

Motor BRUSHLESS

Desempenho significativamente melhorado: maior potência, redução do consumo de energia, vida útil prolongada do motor, fornecimento de energia melhorado do botão

Características principais

- Proteção contra arranque involuntário
- Punho adicional que pode ser montado em ambos os lados
- Resguardo do disco sem ferramentas (libertação rápida)
- Dispositivo de bloqueio do veio para substituição rápida do disco
- Interruptor deslizante on/off
- Entradas de ar protegidas contra infiltração de poeiras, proporcionam um arrefecimento eficaz
- Fornecido em mala rígida, sem baterias e sem carregador

Características técnicas

- Diâmetro do disco (não incluído): 125/115 mm
- Rotações em vazio: 8.000 rpm
- Rosca do veio: M14
- Comprimento do cabo: 4 m

Beta
**3-YEAR
WARRANTY**

DISPONÍVEL
A PARTIR DE MAIO



CE

1986/20V-125BMC

€ 257,00



1



019860025

490x370x125 mm - 3,8 kg



1994B 20V-2AH

bateria de íões de lítio 2Ah, 20V

Tecnologia premium de íões de lítio
Com botão e 3 indicadores LED coloridos de nível de carga

Características principais

- Voltagem da bateria: 20V
- Capacidade da bateria: 2Ah
- Capacidade energética: 40Wh
- Tipo de bateria: Li-ion

📦 410 g



DISPONÍVEL
A PARTIR DE MAIO

CE

1994B 20V-2AH

€ 72,00 1 019940022

1994B 20V-4AH

bateria de íões de lítio 4Ah, 20V

Tecnologia premium de íões de lítio
Com botão e 3 indicadores LED coloridos de nível de carga

Características principais

- Voltagem da bateria: 20V
- Capacidade da bateria: 4Ah
- Capacidade energética: 80Wh
- Tipo de bateria: Li-ion

📦 660 g



DISPONÍVEL
A PARTIR DE MAIO

CE

1994B 20V-4AH

€ 120,00 1 019940044

1994B 20V-6AH

bateria de íões de lítio 6Ah, 20V

Tecnologia premium de íões de lítio
Com botão e 3 indicadores LED coloridos de nível de carga

Características principais

- Voltagem da bateria: 20V
- Capacidade da bateria: 6Ah
- Capacidade energética: 120Wh
- Tipo de bateria: Li-ion

📦 900 g



DISPONÍVEL
A PARTIR DE MAIO

CE

1994B 20V-6AH

€ 166,00 1 019940066

1994C 20V

carregador rápido, 20V, 110V-240V

Características principais:

- Indicador LED de nível de carga
- Voltagem nominal de entrada: 110V-240V ~ 50/60Hz
- Voltagem de saída: 20V
- Corrente de carga: 6A
- Potência nominal de entrada: 145W

Tempo de carregamento da bateria 20V 2Ah: 45 min

Tempo de carregamento da bateria 20V 4Ah: 90 min

Tempo de carregamento da bateria 20V 6Ah: 120 min

📦 570 g



DISPONÍVEL
A PARTIR DE MAIO

CE

1994C 20V

€ 127,00 1 019940140

1989RCB

rádio para estaleiro, 20V

CE

Entretenimento multifunções: rádio FM digital (DAB; BT) e convencional
Adequado para uso em estaleiros de construção ou para lazer

Rádio robusto com design compacto, moderno, grau de proteção IP54
Som estéreo potente fornecido por duas potentes colunas laterais de 16 W
Função de alarme integrada
Completo com punho de transporte e proteção dos cantos anti-impacto
Com ligação AUX e entrada USB protegido para ligação e carregamento do telefone
Pode ser utilizado com baterias de 20V da Beta (opcionais) ou cabo de alimentação (incluído).

Características principais:

- Intervalo de frequência de rádio FM: 87.5 – 108 MHz
- Intervalo de frequência de rádio DAB: 174 – 240 MHz
- Número de estações FM e DAB armazenadas: 30
- Potência das colunas: 16 W
- Potência nominal da bateria (opcional): 20 V
- Dimensões: 180 x 205 x 305 mm
- Peso (sem bateria): 3.2 kg

DISPONÍVEL
A PARTIR DE MAIO



1989RCB

€ 371,00



1



019890020

C9PT

saco para ferramentas elétricas em tecido técnico

Perfeito para transportar convenientemente as ferramentas elétricas Beta

Em tecido técnico de elevada durabilidade

Pega superior dupla para manuseamento seguro e equilibrado

DISPONÍVEL
A PARTIR DE MAIO



C9PT

€ 46,00



1



021090001

400x210x290 mm - 2,4 kg

Beta



A gama de ferramentas com fio inclui **rebarbadoras, berbequins de percussão, aparafusadoras de impacto, aspiradores de sólidos e líquidos, pistolas de ar quente e de cola.**

Em particular, as rebarbadoras Beta (com potências de 750W a 2400W) estão a revelar-se cada vez mais bem-sucedidas com base nas seguintes características de construção:

• **Desempenho excecional**

- Motor potente, com resina, resistente ao desgaste e durável
- Saídas de ar que proporcionam a refrigeração ideal, protegidas contra infiltração de poeiras

• **Segurança inigualável para operadores**

- Dispositivo de bloqueio do veio para substituição rápida do disco
- Proteção contra arranque involuntário
- Arranque suave para limitar picos de corrente no arranque

• **Conforto e facilidade de manuseamento exclusivos**

- Punho ergonómico antiderrapante para maior conforto e segurança
- Cabeça rebaixada que permite trabalhar em espaços reduzidos

Cabo anti-enrolamento não inferior a 4 metros de comprimento para maior facilidade de movimentos

Punho adicional que pode ser montado em ambos os lados.

1956 115-750W

rebarbadora para discos Ø 115 mm

Ideal para trabalhos de corte, rebarbagem e desbaste

Motor potente (750 W)

Punho ergonómico antiderrapante para maior conforto e segurança

Cabeça rebaixada que permite trabalhar em espaços confinados

Extremamente leve (pesa no máximo 1,8 kg)

Principais características

- Proteção contra arranque involuntário
- Punho adicional que pode ser montado em ambos os lados
- Resguardo do disco sem ferramentas (libertação rápida)
- Dispositivo de bloqueio do veio para substituição rápida do disco
- Interruptor deslizante on/off
- Entradas de ar protegidas contra infiltração de poeiras, proporcionam um arrefecimento eficaz
- Chave de serviço incluída

1,8 kg



1956 115-750W

€ 89,00 1 019560011

1956 125-1400W

rebarbadora para discos Ø 125 mm

Ideal para trabalhos de corte, rebarbagem e desbaste

Motor potente (1400 W) - Velocidade variável
Punho ergonómico antiderrapante para maior conforto e segurança
Cabeça rebaixada que permite trabalhar em espaços confinados

Principais características

- Proteção contra arranque involuntário
- Punho adicional antivibrações que pode ser montado em ambos os lados
- Resguardo do disco sem ferramentas (libertação rápida)
- Dispositivo de bloqueio do veio para substituição rápida do disco
- Interruptor deslizante on/off
- Entradas de ar protegidas contra infiltração de poeiras, proporcionam um arrefecimento eficaz
- Chave de serviço incluída

📦 2,5 kg

1956 125-1400W

€ 173,00 1 019560125



1956 230-2400W

rebarbadora para discos Ø 230 mm

Ideal para trabalhos de corte, rebarbagem e desbaste

Motor potente (2400 W) - Velocidade variável
Punho ergonómico antiderrapante para maior conforto e segurança

Principais características

- Proteção contra arranque involuntário
- Arranque suave com limitação da corrente
- Punho adicional antivibrações que pode ser montado em ambos os lados
- Resguardo do disco com parafuso
- Dispositivo de bloqueio do veio para substituição rápida do disco
- Interruptor deslizante on/off
- Entradas de ar protegidas contra infiltração de poeiras, proporcionam um arrefecimento eficaz
- Chave de serviço incluída

📦 5,8 kg

1956 230-2400W

€ 233,00 1 019560230



1966/910W

berbequim de percussão, 910W

Ideal para furar diversos materiais, incluindo madeira, metal, plástico, alvenaria e betão

Motor potente 910W

Design linear e compacto com punho ergonómico e antiderrapante

Bucha automática de 13 mm

Velocidade variável reversível

Caixa de engrenagens inteiramente em metal

Bloqueio do interruptor para maior conforto de utilização

Principais características:

- Diâmetro máx. de perfuração em madeira: 32 mm
- Diâmetro máx. de perfuração em metal: 13 mm
- Diâmetro máx. de perfuração em alvenaria: 13 mm
- Rotações em vazio: 0-2.800 rpm
- Comprimento do cabo: 4 m

Acessórios fornecidos:

- Bucha automática de 13 mm
- Punho lateral adicional com rotação 360°
- Limitador de profundidade

DISPONÍVEL
A PARTIR DE MAIO



1966/910W € 142,00 1 019660091

420x320x120 mm - 4,3 kg

1967/800W

martelo combinado SDS-PLUS, 800W

Ideal para furar, furar com percussão e demolir em alvenaria, betão, azulejos, madeira e metal

Motor potente 800W para aplicações pesadas

Profissional, leve e potente

Design ergonómico, compacto para trabalhar em espaços reduzidos/de difícil acesso

Características principais

3 modos de funcionamento + função Vario-Lock:

- função furar
- função furar com percussão
- função demolir
- função vario-lock: pode ser bloqueado em 36 posições, para obter um ângulo de trabalho ideal

• Diâmetro máx. de perfuração em madeira: 30 mm

• Diâmetro máx. de perfuração em metal: 13 mm

• Diâmetro máx. de perfuração em betão: 26 mm

Reversível

Embraiagem de segurança

Energia máx. por golpe: 3.2 J

Rotações em vazio: 0-1350 rpm

Número máx. de impactos: 0-5700 impactos/min

Comprimento do cabo: 4 m

Acessórios fornecidos:

- Bucha 13 mm com adaptador SDS-PLUS
- Punho lateral adicional com rotação 360°
- Limitador de profundidade
- 3 brocas de percussão, Ø 8-10-12 mm, comp. 150 mm
- 1 escopro plano, 14x250 mm
- 1 ponteiro, 14x250 mm

DISPONÍVEL
A PARTIR DE MAIO



1967/800W € 204,00 1 019670080

420x300x115 mm - 5,2 kg



1850D

pistola térmica de 3 velocidades

- Pos. I 250 l/min 50 °C
- Pos. II 250 l/min 400 °C
- Pos. III 500 l/min 550 °C



1850D	L mm 255	H mm 210	€ 151,00	1	018500018
-------	----------------	----------------	-------------	---	-----------

1850E

pistola térmica eletrônica ajustável

- Pos. I 250-500 l/min 50 °C
- Pos. II 250-500 l/min 50-650 °C

- monitor digital
- botões de regulação da temperatura e fluxo
- 4 programas pré-definidos e outros personalizáveis

- Prog 1 150 °C ca. 400 l/min
- Prog 2 200 °C ca. 400 l/min
- Prog 3 300 °C ca. 450 l/min
- Prog 4 400 °C ca. 500 l/min



1850E	L mm 255	H mm 210	€ 316,00	1	018500020
-------	----------------	----------------	-------------	---	-----------

1851VK

pistola de colagem a quente com 12 tubos de cola em caixa

- potência: 80 W
- para tubos de cola, Ø 11 mm e 12 mm

CE



1851VK	€ 62,50	1	018510058
≡ 320x250x50 mm			

1851VK-12C

12 bastões de cola
Ø 11 mm



1851VK-12C	€ 16,00	1	018510062
------------	------------	---	-----------

1851VK-12V

12 bastões de cola
para superfícies pintadas
Ø 11 mm



1851VK-12V	€ 16,00	1	018510072
------------	------------	---	-----------



1870

aspirador para sólidos e líquidos, 20 l

- motor bypass monofásico
- voltagem: 220/240 V
- frequência: 50/60 Hz
- potência máx.: 1200 W
- débito : 58 l/sec.
- potência máx. de aspiração: 190 mbar
- cap. máx. do tambor: 20 l, em PP antiestático
- emissão sonora: <70 dB(A)
- comp. do cabo: 5 m
- carro para acessórios
- ACESSÓRIOS STANDARD, Ø 36 mm
- 1 tubo flexível com punho ergonómico
- 2 tubos de extensão rígidos
- 1 escova multiusos para soalhos e líquidos
- 1 bocal plano
- SISTEMAS DE FILTRAGEM
- 1 filtro de cartucho de superfície 1900 cm² - 12 µm nom.
- 1 filtro anti-espuma PPI 45/PPI 30

CE



IPX4

1870	€ 269,00	1	018700020
------	-------------	---	-----------

1870I

aspirador para sólidos e líquidos, 20 l,
tambor em aço inox

- motor bypass de um estágio
- voltagem: 220/240 V
- frequência: 50/60 Hz
- potência máx.: 1200 W
- débito: 58 l/seg..
- potência máx. de aspiração: 190 mbar
- capacidade máx. do tambor: 20 l, em aço inox
- emissão sonora: <70 dB(A)
- comprimento do cabo: 5 m
- ACESSÓRIOS STANDARD Ø 36 mm
- 1 tubo flexível com punho ergonómico
- 2 tubos de extensão rígidos
- 1 escova multiusos para chão e líquidos
- 1 bocal plano
- 1 saco de papel
- SISTEMAS DE FILTRAGEM
- 1 filtro de cartucho de superfície 1900 cm² - 12 µm nom.
- 1 filtro anti-espuma PPI 45/PPI 30

CE



IPX4

1870I	€ 299,00	1	018700220
-------	-------------	---	-----------

1872L

aspirador para sólidos e líquidos, 35 l, classe certificada "L"

- by-pass do motor de dois estágios
- voltagem: 220/240 V
- frequência: 50/60 Hz
- potência máx.: 1.100 W
- débito: 55 l/sec.
- potência máx. de aspiração: 220 mbar
- capacidade máx. do tambor: 35 l, antiestático PE-HD
- emissão sonora: <70 dB(A)
- comprimento do cabo: 6 m
- ACESSÓRIOS STANDARD, Ø 36 mm
- 1 tubo flexível com um punho ergonómico
- 2 tubos de extensão em plástico
- 1 escova combinada
- 1 secção com tubos de aspiração de líquidos
- 1 bocal plano
- SISTEMAS DE FILTRAGEM
- 1 saco de filtro em papel; filtragem classe "L"
- 1 filtro de cartucho de superfície; IFA classe: "L"
- 1 filtro anti-espuma PPI 45/PPI 30
- 2 pós-filtros em PET lâmina PP

CE



IPX4

1872L 35 € 590,00 1 018720135

1873

aspirador para sólidos e líquidos, 30 l, tambor em aço inoxidável

- motor bypass de dois estágios
- voltagem: 220/240 V • frequência 50/60 Hz
- potência máx.: 1100 W • débito : 55 l/sec.
- pressão máx. aspiração: 220 mbar
- cap. máx. tambor: 30 l, em aço inoxidável
- emissão sonora: <61 dB(A)
- comp. cabo: 6 m • carro para acessórios
- ACESSÓRIOS STANDAR, Ø 45 mm
- 1 tubo flexível com punho ergonómico
- 2 tubos de extensão em aço inoxidável
- 1 escova industrial
- 1 adaptador industrial para alcatifas
- 1 secção industrial tubos para aspiração de líquidos
- 1 bocal plano • 1 bocal triangular
- SISTEMAS DE FILTRAGEM
- 1 saco de filtro em papel
- 1 filtro de cartucho de superfície 1900 cm², 12 µm nom.
- 1 filtro anti-espuma PPI 45/PPI 30

CE



1873 30 € 785,00 1 018730030

1874

aspirador para sólidos e líquidos, 50 l, tambor em aço inoxidável

- motor bypass de dois estágios
- voltagem: 220/240 V • frequência: 50/60 Hz
- potência máx.: 1350 W • débito : 55 l/sec.
- pressão máx. aspiração: 240 mbar
- cap. máx. do tambor: 50 l, em aço inoxidável
- emissão sonora: <63 dB(A)
- comp. cabo: 6 m • carro para acessórios
- ACESSÓRIOS STANDARD: Ø 45 mm
- 1 tubo flexível com punho ergonómico
- 2 tubos de extensão em aço inoxidável
- 1 escova industrial
- 1 adaptador industrial para alcatifas
- 1 secção industrial com tubos de aspiração de líquidos
- 1 bocal plano
- SISTEMAS DE FILTRAGEM
- 1 saco de filtro em papel
- 1 filtro de cartucho de superfície 5200 cm², 12 µm nom.
- 1 filtro anti-espuma PPI 45/PPI 30

CE



1874 50 € 990,00 1 018740050

1870-20/5S

5 sacos de papel horizontais para artigo 1870- 1870I-1875LT



1870 20/5S € 61,50 1 018700021

1870-72 /FC

filtro de cartucho 1900 cm² 12 - µm nom.
Para artigos 1870 - 1870I - 1873 - 1875LT



1870/FC € 52,50 1 018700026

1870-72/FL

filtro para aspiração de líquidos
para artigos 1870 - 1870I - 1872L - 1873 - 1874 - 1875LT



1870 72/FL € 19,30 1 018700027

1872L 35/FC

filtro de cartucho, classe "L" ,
para artigo 1872L



1872L 35/FC € 63,50 1 018720144

1872L 35/5S

5 sacos de pano descartáveis, classe "L"
para artigo 1872L- 1873



1872L 35/5S € 96,50 1 018720136

1873-30/5S

5 sacos de papel verticais para artigo 1873



1873 30/5S € 61,50 1 018730031

1874-50/5S

5 sacos verticais para artigo 1874



1874 50/5S € 77,50 1 018740051

1874-50/FC

filtro de cartucho 5200 cm² - 12 µm nom.
para artigo 1874



1874 50/FC € 63,00 1 018740056



FERRAMENTAS **PNEUMÁTICAS** E ACESSÓRIOS

Nos últimos 20 anos, a Beta Utensili tem vindo a complementar a sua linha de produtos com uma selecção abrangente de ferramentas pneumáticas e acessórios desenvolvidos para os mercados de manutenção automóvel e industrial: chaves de impacto, roquetes, berbequins, rectificadoras, lixadeiras e muitos outros produtos.



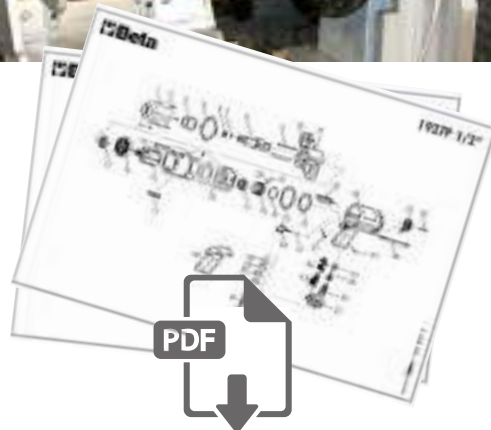

Durante este período, a cooperação estreita com os utilizadores profissionais tem sido a chave para o crescimento contínuo. É com base nesse crescimento que as ferramentas pneumáticas Beta apresentam uma excelente relação fiabilidade/desempenho. Para satisfazer as exigências do mercado, a Beta Utensili efectua a reparação das ferramentas pneumáticas no seu Departamento de Qualidade. Este processo permitiu melhorar o seu know-how de forma significativa e tornar-se cada vez mais sensível à carteira de clientes.





www.beta-tools.com

GUIA DE FERRAMENTAS PNEUMÁTICAS













CHAVES DE IMPACTO

■	BETA ITEM	N °	MATERIAL	 max. Nm	 db (A) LpA	 db (A) LpW	 l/min.	 kg	MECANISMO	 m/s ²
3/8"		1924F	Alumínio	108	93,6	104,6	59	0,5	Mecanismo de impacto duplo	6,85
3/8"		1924B	Alumínio	353	91	95	80	1,5	Mecanismo de impacto "Pin clutch"	7,9
3/8"		1924CD	Material compósito	410	91,7	102,7	79	1,3	Mecanismo de impacto duplo	6,2
3/8"		1924XM	Material compósito	515	91,7	102,7	122	1,3	Mecanismo de impacto simples	6,2
1/2"		1927AN	Alumínio	244	89,4	100,4	190	2,1	Mecanismo de impacto simples	8,63
1/2"		1927G	Alumínio	325	92,2	103,2	113	1,2	Mecanismo de impacto simples	9,96
1/2"		1927B	Alumínio	705	98,0	109,0	133	2,1	Mecanismo de impacto "Pin clutch"	14,08
1/2"		1927XM	Alumínio	770	102	113	122	1,3	Mecanismo de impacto simples	7,5
1/2"		1927CD	Material compósito	1.020	95,5	106,5	130	2,3	Mecanismo de impacto duplo	7,2
1/2"		1927P	Material compósito	1.750	95,1	106,1	290	2,0	Mecanismo de impacto duplo	6,7
3/4"		1928XM	Alumínio	1.600	91,8	102,8	175	2,9	Mecanismo de impacto duplo	12,96
3/4"		1928DA	Alumínio	1.695	96	99,5	300	4,3	Mecanismo de impacto duplo	3,6
3/4"		1928DAL	Alumínio	1.695	96	99,5	300	4,8	Mecanismo de impacto duplo	3,6
3/4"		1928CD	Material compósito	1.800	97,5	108,5	215	3,5	Mecanismo de impacto duplo	11,4
3/4"		1928P	Material compósito	2.100	96,2	107,2	221	3,7	Mecanismo de impacto duplo	7,6
1"		1930CD	Material compósito	2.445	95,6	97,1	410	7,1	Mecanismo de impacto duplo	3,6
1"		1930PA	Alumínio	2.445	96,0	97,1	410	9,6	Mecanismo de impacto duplo	7,2
1"		1930A	Alumínio	2.445	103,3	114,3	460	9,5	Mecanismo de impacto duplo	67
1"		1930LH	Alumínio	2.441	97,1	108,1	282	7,1	Mecanismo de impacto duplo	17,4
1"		1930LA	Alumínio	2.445	95,6	97,1	460	10,6	Mecanismo de impacto duplo	3,6



GUIA DE FERRAMENTAS PNEUMÁTICAS

■	BETA ITEM	N°	MATERIAL	max. Nm	db (A) LpA	db (A) LpW	l/min.	kg	MECANISMO	m/s ²
1"		1930HLA	Alumínio	3.661	99	101	460	16,4	Double hammer	16,4
1 1/2"		1930ZL	Alumínio	4.068	102,4	113,4	480	15	Double hammer	69.6

ROQUETES PNEUMÁTICOS

■	BETA ITEM	N°	 max. Nm	 db (A) LpA	 db (A) LpW	 l/min.	 kg	 m/s ²
14"		1921B1	24	96	85	90	0,4	2.6
14"		1921M1	27	84	88	96	0,6	1.8
14"		1922P1	68	90,6	101,6	88	0,6	8.61
3/8"		1921M2	27	84	88	96	0,6	1.8
3/8"		1922P2	68	90,6	101,6	88	0,6	8.61
12"		1921N3	68	80	87	140	1,2	2.6
12"		1922P3	136	94,9	105,9	113	1,5	18.28

RECTIFICADORAS

	BETA ITEM	N°	POTÊNCIA	 db (A) LpA	 db (A) LpW	 l/min.	 kg	 m/s ²
		1933	0,20 kW	80,0	87,0	230	0,38	4,53
		1933L	0,20 kW	80,0	87,0	270	0,67	1,15
		1933AN90	0,20 kW	80,0	87,0	230	0,51	1,24
		1933I	0,38 kW	80,0	87,0	260	0,67	4,53
		1933IL	0,38 kW	79,0	97,0	113	1,4	1,6
		1933IH	0,75 kW	88,1	99,1	370	0,8	2,6
		1933ILH	0,75 kW	85,7	96,7	370	1,2	1,4
		1933AN90-H	0,75 kW	85,6	96,6	370	1,1	6,7
		1934MAV	0,04 kW	71	76	115	0,2	2,5
		1934MAV70	0,08 kW	80	87	115	0,2	4

1921B1

mini roquete pneumático reversível

1/4"

CE



130 mm

Rotação em vazio	350 rpm
Torque max.	24 Nm
Capacidade parafuso	Cl 8.8 M7●11 mm
Capacidade parafuso	Cl 12.9 M6●10 mm
Entrada de ar	1/4" GAS
Pressão de trabalho	6,2 bar
Ø interno do tubo	8 mm
Consumo médio de ar	68 l/min
Peso	0,4 kg

1/4	€ 226,00	1	019210001
-----	----------	---	-----------

1921M1

roquete pneumático reversível

• Manipulo regulador de velocidade

1/4"

CE



198 mm

Rotação em vazio	200 rpm
Torque max.	27 Nm
Capacidade parafuso	Cl 8.8 M7●11 mm
Capacidade parafuso	Cl 12.9 M6●10 mm
Entrada de ar	1/4" GAS
Pressão de trabalho	6,2 bar
Ø interno do tubo	8 mm
Consumo médio de ar	96 l/min
Peso	0,6 kg

1/4	kg 0,6	€ 200,00	1	019210005
-----	--------	----------	---	-----------

1921M2

roquete pneumático compacto reversível

• Manipulo regulador de velocidade

3/8"

CE



198 mm

Rotação em vazio	200 rpm
Torque max.	27 Nm
Capacidade parafuso	Cl 8.8 M7●11 mm
Capacidade parafuso	Cl 12.9 M6●10 mm
Entrada de ar	1/4" GAS
Pressão de trabalho	6,2 bar
Ø interno do tubo	8 mm
Consumo médio de ar	96 l/min
Peso	0,6 kg

3/8	kg 0,6	€ 200,00	1	019210015
-----	--------	----------	---	-----------

1921N3

roquete pneumático reversível

• Manipulo regulador de velocidade

1/2"

CE



258 mm

Rotação em vazio	150 rpm
Torque max.	68 Nm
Capacidade parafuso	Cl 8.8 M10●16 mm
Capacidade parafuso	Cl 12.9 M8●13 mm
Entrada de ar	1/4" GAS
Pressão de trabalho	6,2 bar
Ø interno do tubo	10 mm
Consumo médio de ar	140 l/min
Peso	1,2 kg

1/2	kg 1,2	€ 200,00	1	019210025
-----	--------	----------	---	-----------

1922P1

roquete reversível com superfície de percussão

• Dispositivo de impulso especial "Double rocking dog"

1/4"

CE



164 mm

Velocidade	700 rpm
Binário máximo	68 Nm
Capacidade do parafuso	Cl 8.8 M10●16 mm
Capacidade do parafuso	Cl 12.9 M8●13 mm
Entrada de ar	1/4" GAS
Pressão de trabalho	6,2 bar
Ø interno do tubo	10 mm
Consumo médio de ar	88 l/min
Peso	0,6 kg

1/4	kg 0,6	€ 242,00	1	019220006
-----	--------	----------	---	-----------

1922P2

roquete reversível com superfície de percussão

• Dispositivo de impulso especial "Double rocking dog"

3/8"

CE



164 mm

Velocidade	700 rpm
Binário máximo	68 Nm
Capacidade do parafuso	Cl 8.8 M10●16 mm
Capacidade do parafuso	Cl 12.9 M8●13 mm
Entrada de ar	1/4" GAS
Pressão de trabalho	6,2 bar
Ø interno do tubo	10 mm
Consumo médio de ar	88 l/min
Peso	0,6 kg

3/8	kg 0,6	€ 242,00	1	019220010
-----	--------	----------	---	-----------

1922P3

roquete reversível com superfície de percussão

• Dispositivo de impulso especial "Double rocking dog"

1/2"

CE



292 mm

Velocidade	600 rpm
Binário máximo	136 Nm
Capacidade do parafuso	Cl 8.8 M12●18 mm
Capacidade do parafuso	Cl 12.9 M10●16 mm
Entrada de ar	1/4" GAS
Pressão de trabalho	6,2 bar
Ø interno do tubo	10 mm
Consumo médio de ar	113 l/min
Peso	1,5 kg

1/2	kg 1,5	€ 382,00	1	019220013
-----	--------	----------	---	-----------

1924F

chave de impacto reversível tipo borboleta

• Dispositivo de impulso especial "Double rocking dog"

3/8"

CE



139 mm

Velocidade	12,000 rpm
Binário máximo	108 Nm
Capacidade do parafuso	Cl 8.8 M12●18 mm
Capacidade do parafuso	Cl 12.9 M10●16 mm
Entrada de ar	1/4" GAS
Pressão de trabalho	6,2 bar
Ø interno do tubo	10 mm
Consumo médio de ar	59 l/min
Peso	0,5 kg

3/8	kg 0,5	€ 224,00	1	019240025
-----	--------	----------	---	-----------



1924B

chave de impacto compacta reversível

- Dispositivo de impacto "Pin Clutch"



Rotação em vazio	10,000 rpm
Torque máx.	353 Nm
Capacidade parafuso	CI 8.8 M16●24 mm
Capacidade parafuso	CI 12.9 M14●21 mm
Entrada de ar	1/4" GAS
Pressão de trabalho	6,2 bar
(Ø) interno do tubo	8 mm
Consumo médio de ar	80 l/min
Peso	1,5 kg

3/8"	kg 1,5	€ 257,00	1	019240021
------	--------	----------	---	-----------

1924XM

chave de impacto reversível compacta

- Dispositivo de impacto único



Velocidade livre	9,000 rpm/min
Torque máx.	515 Nm
Capac. Parafuso	CI 8.8 M16●24 mm
Capac. Parafuso	CI 12.9 M14●21 mm
Admissão de ar	1/4" GAS
Pressão de trabalho	6,2 bar
Dimensão interna do tubo (Ø)	10 mm
Consumo de ar médio	122 l/min
Peso	1,3 kg

3/8"	kg 1,3	€ 248,00	1	019240030
------	--------	----------	---	-----------

1927B

chave de impacto reversível

- Dispositivo de impulso "Pin Clutch"



Rotação em vazio	7,000 rpm
Torque máx.	705 Nm
Capacidade parafuso	CI 8.8 M22●34 mm
Capacidade parafuso	CI 12.9 M18●27 mm
Entrada de ar	1/4" GAS
Pressão de trabalho	6,2 bar
Ø interno do tubo	10 mm
Consumo médio de ar	133 l/min
Peso	2,1 kg

1/2"	kg 2,1	€ 173,00	1	019270022
------	--------	----------	---	-----------

1924CD

chave de impacto pneumática reversível, em material compósito

- Dispositivo de impacto duplo



Rotação em vazio	10,000 rpm
Torque máx.	410 Nm
Capacidade parafuso	CI 8.8 M16●24 mm
Capacidade parafuso	CI 12.9 M14●21 mm
Entrada de ar	1/4" GAS
Pressão de trabalho	6,2 bar
(Ø) interno do tubo	8 mm
Consumo médio de ar	79 l/min
Peso	1,3 kg

3/8"	kg 1,3	€ 311,00	1	019240007
------	--------	----------	---	-----------



1927B/K5

chave de impacto reversível, em alumínio, fornecida com 5 chaves de caixa de impacto, em estojo



Rotações em vazio	7,000 rpm
Binário máx.	705 Nm
Capacidade parafuso	CI 8.8 M22●34 mm
Capacidade parafuso	CI 12.9 M18●27 mm
Entrada de ar	1/4" GAS
Pressão de trabalho	6,2 bar
(Ø) interno do tubo	10 mm
Consumo médio de ar	133 l/min
Peso	2,1 kg

1/2"	kg 3,5	€ 228,00	1	019270122
350x305x86 mm				

1927CD

chave de impacto pneumática reversível,
em material compósito

• Dispositivo de impacto duplo

12"

CE



Ø 1/4" GAS BSP

Rotação em vazio	7,000 rpm
Torque máx.	1.020 Nm
Capacidade parafuso	Cl 8.8 M22●34 mm
Capacidade parafuso	Cl 12.9 M18●27 mm
Entrada de ar	1/4" GAS
Pressão de trabalho	6,2 bar
(Ø) interno do tubo	10 mm
Consumo médio de ar	130 l/min
Peso	2,3 kg

1/2 2,3 € 358,00 1 019270007

1927CD/K3

jogo de 1 chave de impacto pneumática
reversível e 3 chaves de caixa de impacto

• Dispositivo de impacto duplo

12"

CE



720LC17-19-21 mm

Rotações em vazio	7,000 rpm
Binário máx.	1.020 Nm
Capacidade parafuso	Cl 8.8 M22●34 mm
Capacidade parafuso	Cl 12.9 M18●27 mm
Entrada de ar	1/4" GAS
Pressão de trabalho	6.2 bars
Diâm. Interno do tubo (Ø)	10 mm
Consumo médio de ar	130 l/min
Peso	1.9 kg

1/2 kg 4 € 402,00 1 019270107
350x305x86 mm

1927P

chave de impacto reversível em material
composito

• Mecanismo de impacto duplo

12"

CE



Ø 1/4" GAS BSP

Velocidade	7,500 rpm
Binário máx.	1.750 Nm
Capacidade do parafuso	Cl 8.8 M24●36 mm
Capacidade do parafuso	Cl 12.9 M20●30 mm
Entrada de ar	1/4" GAS
Pressão de trabalho	6,2 bar
Diâm. interno do tubo	10 mm
Consumo médio de ar	290 l/min
Peso	2 kg

1/2 kg 2,0 € 390,00 1 019270008

1927P/K3

chave de impacto reversível, em material
compósito, fornecida com 3 chaves de caixa
de impacto

12"

CE



720LC17-19-21 mm

Velocidade em vazio	7,500 rpm
Binário máx.	1.750 Nm
Capacidade do parafuso	Cl 8.8 M24●36 mm
Capacidade do parafuso	Cl 12.9 M20●30 mm
Entrada de ar	1/4" GAS
Pressão de trabalho	6.2 bar
Ø interno do tubo	10 mm
Consumo médio de ar	290 l/min
Peso	2.9 kg

1/2 kg 4 € 455,00 1 019270118
350x305x86 mm

1927XM

chave de impacto compacta reversível

• Dispositivo de impacto simples

12"

CE



Ø 1/4" GAS BSPT

Velocidade livre	10,000 rpm
Torque máx.	770 Nm
Capacidade parafuso	Cl 8.8 M22●34 mm
Capacidade parafuso	Cl 12.9 M18●27 mm
Entrada de ar	1/4" GAS
Pressão de trabalho	6,2 bar
Dimens. tubo interno (Ø)	10 mm
Consumo de ar médio	122 l/min
Peso	1.3 kg

1/2 kg 1,3 € 264,00 1 019270030

1927XM/K5

Jogo de uma chave de impacto compacta
reversível e cinco chaves de impacto

• Mecanismo de impacto simples

12"

CE



720 17-19-21-22-24 mm

Velocidade em vazio	10,000 rpm
Torque máx.	770 Nm
Capacidade do parafuso	Cl 8.8 M22●34 mm
Capacidade do parafuso	Cl 12.9 M18●27 mm
Entrada de ar	1/4" GAS
Pressão de trabalho	6.2 bar
Diâmetro interno do tubo	10 mm
Consumo médio de ar	122 l/min
Peso	1.3 kg

1/2 kg 2,8 € 321,00 1 019270129
307x206x86 mm

1927AN

Chave de impacto angular reversível

- Dispositivo de impacto simples

12"

CE



Rotações em vazio	4,700 rpm
Binário máx.	244 Nm
Capacidade parafuso	CI 8.8 M14●21 mm
Capacidade parafuso	CI 12.9 M12●19 mm
Entrada de ar	1/4" GAS
Pressão de trabalho	6,2 bar
Ø interno do tubo	10 mm
Consumo médio de ar	190 l/min
Peso	2,1 kg

1/2"	kg	€	1	019270012
2,1	465,00			

1927G

chave de impacto reversível compacta

- Dispositivo de impulso simples

12"

CE



Rotação em vazio	8500 rpm
Torque máx.	325 Nm
Capacidade parafuso	CI 8.8 M16●24 mm
Capacidade parafuso	CI 12.9 M14●21 mm
Entrada de ar	1/4" GAS
Pressão de trabalho	6,2 bar
Ø interno do tubo	10 mm
Consumo médio de ar	113 l/min
Peso	1,2 kg

1/2"	kg	€	1	019270050
1,2	382,00			

1927SP-AM

suporte magnético para chave de impacto

- Possui dois ímãs de elevado magnetismo com protecção de borracha nas extremidades
- Pode alojar 1 chave de impacto 1/2", 4 chaves de caixa e 1 chave dinamométrica
- Capacidade: 10 kg



g	€	1	019270000
400	57,00		

1928DA

chave de impacto pneumática reversível

- Dispositivo de impacto duplo

3/4"

CE



Rotação em vazio	5,000 rpm
Torque máx.	1.695 Nm
Capacidade parafuso	CI 8.8 M30●46 mm
Capacidade parafuso	CI 12.9 M27●41 mm
Entrada de ar	3/8" GAS
Pressão de trabalho	6,2 bar
(Ø) interno do tubo	10 mm
Consumo médio de ar	240 l/min
Peso	4,3 kg

3/4"	kg	€	1	019280022
4,3	755,00			

1928DAL

Chave de impacto pneumática reversível

- Dispositivo de impacto duplo

3/4"

CE



Rotação em vazio	5,000 rpm
Torque máx.	1.695 Nm
Capacidade parafuso	CI 8.8 M27●41 mm
Capacidade parafuso	CI 12.9 M24●36 mm
Entrada de ar	3/8" GAS
Pressão de trabalho	6,2 bar
(Ø) interno do tubo	10 mm
Consumo médio de ar	240 l/min
Peso	4,8 kg

3/4"	kg	€	1	019280023
4,8	810,00			

1928K4

jogo de uma chave pneumática de impacto com quatro chaves de caixa, série longa

- Dispositivo de impulso "Pin Clutch"

3/4"

CE



Rotação em vazio	4,000 rpm
Torque máx.	1.493 Nm
Capacidade parafuso	CI 8.8 M27●41 mm
Capacidade parafuso	CI 12.9 M24●36 mm
Entrada de ar	3/8" GAS BSP
Pressão de trabalho	6,2 bar
(Ø) interno do tubo	10 mm
Consumo médio de ar	260 l/min
Peso chave de impacto pneumática	5,2 kg

3/4"	kg	€	1	019280104
9,3	770,00			
410x330x106 mm				

1928XM

chave de impacto reversível compacta

- Dispositivo de impacto duplo
- Incrivelmente compacta e potente
- Comando de inversão com uma mão
- Três níveis de aperto reguláveis
- Exaustão através do punho

3/4"

CE



Rotação no vazio	4,800 rpm
Binário máx.	1.600 Nm
Capacidade parafuso	CI 8.8 M27●41 mm
Capacidade parafuso	CI 12.9 M24●36 mm
Entrada de ar	3/8" GAS
Pressão de trabalho	6,2 bar
(Ø) interno do tubo	10 mm
Consumo médio de ar	175 l/min
Peso	2,9 kg

3/4"	kg	€	1	019280030
2,9	525,00			

1928CD

chave de impacto pneumática reversível,
em material compósito

• Dispositivo de impacto duplo



Rotação em vazio 4,500 rpm
Torque máx. 1.800 Nm
Capacidade parafuso CI 8.8 M27 ● 41 mm
Capacidade parafuso CI 12.9 M24 ● 36 mm
Entrada de ar 3/8" GAS
Pressão de trabalho 6,2 bar
(Ø) interno do tubo 10 mm
Consumo médio de ar 215 l/min
Peso 3,5 kg

3/4 kg 860,00 1 019280007

1928P

chave de impacto reversível, em material
compósito

• Mecanismo de impacto duplo



Rotações em vazio 5,000 rpm
Binário máx. 2,100 Nm
Capacidade do parafuso CI 8.8 M30 ● 46 mm
Capacidade do parafuso CI 12.9 M27 ● 41 mm
Entrada de ar 3/8" GAS
Pressão de trabalho 6,2 bar
Ø interno do tubo 10 mm
Consumo médio de ar 221 l/min
Peso 3,7 kg

3/4 kg 1.040,00 1 019280006

1930LH

chave de impacto reversível

• Dispositivo de impacto duplo

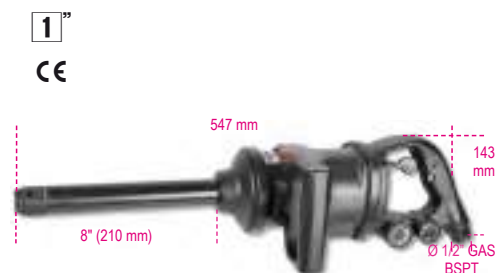

Rotação em vazio 6,000 rpm
Torque máx. 2,441 Nm
Capacidade parafuso CI 8.8 M36 ● 55 mm
Capacidade parafuso CI 12.9 M30 ● 46 mm
Entrada de ar 1/2" GAS
Pressão de trabalho 6,2 bar
Ø interno do tubo 13 mm
Consumo médio de ar 280 l/min
Peso 7,1 kg

1 kg 1.170,00 1 019300030

1930CD

chave de impacto pneumática reversível, em
material compósito

• Dispositivo de impacto duplo



Rotação em vazio 4,000 rpm
Torque máx. 2,445 Nm
Capacidade parafuso CI 8.8 M36 ● 55 mm
Capacidade parafuso CI 12.9 M30 ● 46 mm
Entrada de ar 1/2" GAS
Pressão de trabalho 6,2 bar
(Ø) interno do tubo 13 mm
Consumo médio de ar 320 l/min
Peso 7,1 kg

1 kg 1.260,00 1 019300022

1930PA

chave de impacto reversível

• Mecanismo de impacto duplo



Velocidade 3,500 rpm
Binário máx. 2,445 Nm
Capacidade do parafuso CI 8.8 M36 ● 55 mm
Capacidade do parafuso CI 12.9 M30 ● 46 mm
Entrada de ar 1/2" GAS
Pressão de trabalho 6,2 bar
Diâm. interno do tubo 13 mm
Consumo médio de ar 350 l/min
Peso 9,6 kg

1 kg 1.130,00 1 019300032

Beta

1930LA

chave pneumática de impacto reversível

• Dispositivo de impacto duplo



Rotação em vazio	4,000 rpm
Torque máx.	2.445 Nm
Capacidade parafuso	CI 8.8 M36●55 mm
Capacidade parafuso	CI 12.9 M30●46 mm
Entrada de ar	1/2" GAS
Pressão de trabalho	6,2 bar
(Ø) interno do tubo	13 mm
Consumo médio de ar	460 l/min
Peso	10,6 kg

■	kg	€	1	019300037
1	10,6	1.190,00	1	

1930HLA

chave de pancada reversível

• Mecanismo de impacto duplo



Rotação em vazio	3,000 rpm
Torque máx.	3.661 Nm
Capacidade parafuso	CI 8.8 M42●65 mm
Capacidade parafuso	CI 12.9 M33●50 mm
Entrada de ar	1/2" GAS
Pressão de trabalho	6,2 bar
(Ø) interno do tubo	13 mm
Consumo médio de ar	460 l/min
Peso	16,4 kg

■	kg	€	1	019300040
1	16,4	1.640,00	1	

1931CD6

berbequim pneumático reversível, em material composto



Rotação em vazio	2,600 rpm
Capacidade da bucha	1÷6 mm
Potência	0,23 kW
Rosca do veio	3/8" - 24UNF
Entrada de ar	1/4" GAS
Pressão de trabalho	6,2 bar
(Ø) interno do tubo	8 mm
Consumo médio de ar	130 l/min
Peso	0,6 kg

■	kg	€	1	019310006
0,6		241,00	1	

1930A

chave de impacto reversível

• Dispositivo de impacto duplo



Velocidade em vazio	4,000 rpm
Binário máx.	2.445 Nm
Capacidade parafuso	CI 8.8 M36●55 mm
Capacidade parafuso	CI 12.9 M30●46 mm
Entrada de ar	1/2" GAS
Pressão de trabalho	6,2 bar
(Ø) interno do tubo	13 mm
Consumo médio de ar	460 l/min
Peso	9,5 kg

■	kg	€	1	019300036
1	9,5	1.150,00	1	

1930ZL

chave de pancada reversível

• Mecanismo de impacto duplo



Rotação em vazio	3,000 rpm
Torque máx.	4.068 Nm
Capacidade parafuso	CI 8.8 M42●65 mm
Capacidade parafuso	CI 12.9 M36●55 mm
Entrada de ar	1/2" GAS
Pressão de trabalho	6,2 bar
(Ø) interno do tubo	13 mm
Consumo médio de ar	480 l/min
Peso	15 kg

■	kg	€	1	019300070
1 1/2	15	2.070,00	1	

1931CD10

berbequim pneumático reversível, em material composto



Rotação em vazio	1,800 rpm
Capacidade da bucha	1÷10 mm
Potência	0,38 kW
Rosca do veio	3/8" - 24UNF
Entrada de ar	1/4" GAS
Pressão de trabalho	6,2 bar
(Ø) interno do tubo	10 mm
Consumo médio de ar	170 l/min
Peso	1 kg

■	kg	€	1	019310010
1,0		217,00	1	

1931CD13

berbequim pneumático reversível, em material composto



Rotação em vazio	800 rpm
Capacidade da bucha	1,0÷13 mm
Potência	0,38 kW
Rosca do veio	1/2" - 20UNC
Entrada de ar	1/4" GAS
Pressão de trabalho	6,2 bar
(Ø) interno do tubo	10 mm
Consumo médio de ar	170 l/min
Peso	1,3 kg

kg 1,3 € 322,00 1 019310013

1932B10

berbequim pneumático reversível



Rotação em vazio	1,800 rpm
Capacidade da bucha	1÷10 mm
Potência	0,44 kW
Rosca do veio	3/8" - 24UNF
Entrada de ar	1/4" GAS
Pressão de trabalho	6,2 bar
(Ø) interno do tubo	10 mm
Consumo médio de ar	160 l/min
Peso	1,2 kg

kg 1,2 € 173,00 1 019320040

1932B13

berbequim pneumático reversível



Rotação em vazio	400 rpm
Capacidade da bucha	1,5÷13 mm
Potência	0,34 kW
Rosca do veio	1/2" - 20UNC
Consumo de ar	1/4" GAS
Pressão de trabalho	6,2 bar
Ø interno do tubo	10 mm
Consumo médio de ar	180 l/min
Peso	1,6 kg

kg 1,6 € 258,00 1 019320004

1931AN10

berbequim pneumático angular reversível



Rotação em vazio	1,400 rpm
Capacidade da bucha	1÷10 mm
Potência	0,38 kW
Rosca do veio	3/8" - 24UNF
Entrada de ar	1/4" GAS
Pressão de trabalho	6,2 bar
(Ø) interno do tubo	10 mm
Consumo médio de ar	150 l/min
Peso	1,1 kg

kg 1,1 € 241,00 1 019310030

1932RS13

berbequim pneumático reversível



Rotação em vazio	750 rpm
Capacidade da bucha	1,5÷13 mm
Potência	0,55 kW
Rosca do veio	3/8" - 24UNF
Entrada de ar	1/4" GAS
Pressão de trabalho	6,2 bar
(Ø) interno do tubo	10 mm
Consumo médio de ar	160 l/min
Peso	1,4 kg

kg 1,4 € 219,00 1 019320043

1933IH

retificadora pneumática de alta potência

• Bucha, Ø 3 mm e 6 mm



Velocidade em vazio	20,000 rpm
Capacidade da bucha	3 - 6 mm
Potência	0,75 kW
Entrada de ar	1/4" GAS
Pressão de trabalho	6,2 bar
Ø interno do tubo	10 mm
Consumo médio de ar	370 l/min
Peso	800 g

g 800 € 196,00 1 019330006

Beta
QUALITY TOOLS

1933ILH

retificadora pneumática longa de alta potência

- Bucha, Ø 3 mm e 6 mm

CE



Velocidade em vazio	20,000 rpm
Capacidade da bucha	3 - 6 mm
Potência	0,75 kW
Entrada de ar	1/4" GAS
Pressão de trabalho	6,2 bar
Ø interno do tubo	10 mm
Consumo médio de ar	370 l/min
Peso	1,2 kg

kg 1,2 € 368,00 1 019330011

1933AN90-H

rebarbadora pneumática de alta potência

- Bucha, Ø 3 mm e 6 mm

CE



Velocidade em vazio	15,000 rpm
Capacidade da bucha	3 - 6 mm
Potência	0,75 kW
Entrada de ar	1/4" GAS
Pressão de trabalho	6,2 bar
Ø interno do tubo	10 mm
Consumo médio de ar	370 l/min
Peso	1,1 kg

kg 1,1 € 368,00 1 019330021

1933

retificadora pneumática

- Pinça de Ø 3 mm e 6 mm

CE



Rotação em vazio	25,000 rpm
Capacidade da pinça	3 - 6 mm
Potência	0,20 kW
Entrada de ar	1/4" GAS
Pressão de trabalho	6,2 bar
Ø interno do tubo	10 mm
Consumo médio de ar	230 l/min
Peso	380 g

kg 0,380 € 129,00 1 019330001

1933I

retificadora pneumática

- Bucha coletora, Ø 3 mm e 6 mm

CE



Rotação em vazio	20,000 rpm
Capacidade da bucha	3 - 6 mm
Potência	0,38 kW
Entrada de ar	1/4" GAS
Pressão de trabalho	6,2 bar
Ø interno do tubo	10 mm
Consumo médio de ar	260 l/min
Peso	670 g

g 670 € 146,00 1 019330005

1933L

retificadora pneumática longa

- Bucha coletora, Ø 3 mm e 6 mm

CE



Rotação em vazio	25,000 rpm
Capacidade da bucha	3 - 6 mm
Potência	0,20 kW
Entrada de ar	1/4" GAS
Pressão de trabalho	6,2 bar
Ø interno do tubo	10 mm
Consumo médio de ar	270 l/min
Peso	670 g

g 670 € 164,00 1 019330015

1933IL

retificadora de veio longo

- Bucha coletora, Ø 3 mm e 6 mm

CE



Rotação em vazio	20,000 rpm
Capacidade da bucha	3 - 6 mm
Potência	0,38 kW
Entrada de ar	1/4" GAS
Pressão de trabalho	6,2 bar
Ø interno do tubo	10 mm
Consumo médio de ar	113 l/min
Peso	1,4 kg

kg 1,4 € 199,00 1 019330010

1933AN90

retificadora pneumática angular

- Bucha coletora, Ø 3 mm e 6 mm

CE



Rotação em vazio	20,000 rpm
Capacidade da bucha	3 - 6 mm
Potência	0,20 kW
Entrada de ar	1/4" GAS
Pressão de trabalho	6,2 bar
Ø interno do tubo	10 mm
Consumo médio de ar	230 l/min
Peso	510 g

g 510 € 164,00 1 019330020

1934BV

retificadora de baixa rotação para pneus

- Bucha coletora, Ø 3 mm e 6 mm

CE



Velocidade	3,700 rpm
Capacidade da bucha	3 - 6 mm
Potência	0,37 kW
Entrada de ar	1/4" GAS
Pressão de trabalho	6,2 bar
Diâm. interno do tubo	10 mm
Consumo médio de ar	113 l/min
Peso	0,84 kg

g 840 € 178,00 1 019340000



1934MAV

micro rectificadora

CE



Velocidade	56,000 rpm
Capacidade da bucha	3 mm
Potência	0,04 kW
Entrada de ar	1/4" GAS BSPT
Pressão de trabalho	6,2 bar
Diâm. interno do tubo	4,5 mm
Consumo médio de ar	115 l/min
Peso	0.2 kg

g 205 € 152,00 1 019340010

1934MAV70

micro-rectificadora de alta rotação

CE



Velocidade	70,000 rpm
Capacidade da bucha	3 mm
Potência	0,08 kW
Entrada de ar	1/4" GAS BSPT
Pressão de trabalho	6,2 bar
Diâm. interno do tubo	4,5 mm
Consumo médio de ar	115 l/min
Peso	0.21 kg

g 210 € 253,00 1 019340030

1935F

aparafusadora pneumática reversível

1/4

CE



Rotação em vazio	800 rpm
Torque máximo	4-16 Nm
Capacidade parafuso	6-9 M
Quadra	● 1/4"
Entrada de ar	1/4" GAS
Pressão de trabalho	6,2 bar
Ø interno do tubo	10 mm
Consumo médio de ar	150 l/min
Peso	1,3 kg

kg 1,3 € 241,00 1 019350045

1936/4A

rebarbadora

CE



Rotações em vazio	11,000 rpm
Dimensões do disco	115 mm
Potência	0,66 kW
Rosca do veio	M14
Entrada de ar	1/4" GAS
Pressão de trabalho	6,2 bar
Ø interno do tubo	10 mm
Consumo médio de ar	390 l/min
Peso	1.77 kg

kg 1,8 € 397,00 1 019360024

1936/5A

rebarbadora pneumática

CE



Rotações em vazio	10,000 rpm
Dimensões do disco	125 mm
Potência	0,66 kW
Rosca do veio	M14
Entrada de ar	1/4" GAS
Pressão de trabalho	6,2 bar
Ø interno do tubo	10 mm
Consumo médio de ar	390 l/min
Peso	1,9 kg

kg 1,9 € 397,00 1 019360025

1936/7A

rebarbadora pneumática

CE



Rotações em vazio	7600 giri/min
Dimensões do disco	180 mm
Potência	1,3 kW
Rosca do veio	M14
Entrada de ar	3/8" GAS
Pressão de trabalho	6,2 bar
Ø interno do tubo	13 mm
Consumo médio de ar	906 l/min
Peso	2,7 kg

kg 2,7 € 585,00 1 019360027



1937

Lixadeira de disco orbital, isenta de lubrificação, em material compósito

• Diâmetro orbital: 5 mm



Oscilações em vazio	12,000 rpm
Potência	0,18 kW
Diâmetro do disco	150 mm
Diâmetro orbital	5 mm
Rosca do veio	5/16"-24
Entrada de ar	1/4" GAS
Pressão de trabalho	6,2 bar
Ø interno do tubo	10 mm
Consumo médio de ar	170 l/min
Peso	0,86 kg

kg	€		
0,86	419,00	1	019370001

1937R/P

prato 6 furos, Ø 150 mm, para ref. 1937



1937R/P	€		
	43,50	1	019370002

1937KC

mini lixadeira roto-orbital

- Diâmetro orbital 4 mm
- 2 discos de lixar (Ø 50 mm e Ø 75 mm)
- 10 discos de lixa abrasiva (Ø 50 mm), grão 400, 600, 800
- 10 discos de lixa abrasiva (Ø 75 mm), grão 400, 600, 800



Velocidade livre	15000
Potência	0,25
Dimensões disco	50 - 75
Rosca do veio	M6 x 1,0
Entrada de ar	1/4"
Pressão de trabalho	6,2 bar
Dimensão interna tubo (Ø)	10
Consumo médio de ar	79
Peso lixadeira	0,64
Peso do kit	1,4

kg	€		
1,4	240,00	1	019370171

1937C...

discos de lixa abrasiva para artigo 1937KC



Ø mm	P	€		
50	400	14,40	1	019370175
50	600	14,40	1	019370176
50	800	14,40	1	019370177
75	400	18,20	1	019370178
75	600	18,20	1	019370179
75	800	18,20	1	019370180

* Preços para 10 unidades

1937KL

mini polidora

- Disco de polir (Ø 75 mm)
- 2 esponjas de polimento (Ø 90 mm) - 1937/KL-DSB, 1937/KL-DSG
- Disco de polir em lã (Ø 90 mm) - 1937/KL-DLA



Velocidade livre	3,200 rpm
Potência	0,25 kW
Dimensões disco	75 mm
Rosca do veio	M6
Entrada de ar	1/4" GAS
Pressão de trabalho	6,2 bar
Dimensão interna tubo (Ø)	10 mm
Consumo médio de ar	91 l/min
Peso polidora	0,75 kg
Peso do kit	1,8 kg

kg	€		
1,8	261,00	1	019370161

1937KL-D

acessórios para artigo 1937KL



	Ø mm	€		
1937KL-DLA	90	23,60	1	019370164
1937KL-DSB	90	23,60	1	019370165
1937KL-DSG	90	23,60	1	019370166

1937K...

pratos para artigos 1937KC e 1937KL



	Ø mm	1937KC	1937KL	€		
1937KC-RP	50	•		26,00	1	019370173
1937KL-RP	75	•	•	31,00	1	019370163

1937M

Lixadeira multiusos com 16 acessórios



Rotações em vazio	3,500 rpm
Potência	0,34 kW
Entrada de ar	1/4" GAS
Pressão de trabalho	6,2 bar
(Ø) interno do tubo	10 mm
Consumo médio de ar	113 l/min
Peso lixadeira	1,5 kg
Peso kit	4,5 kg

kg	€		
4,5	725,00	1	019370011

458x495x116 mm

1937M-01÷11

acessórios para ref. 1937M



	L mm	1937M-	€		
1937M-01	30		27,00	1	019370101
1937M-02	30		27,00	1	019370102
1937M-03	11		23,60	1	019370103
1937M-04	23		23,60	1	019370104
1937M-05	11		23,60	1	019370105
1937M-06	23		23,60	1	019370106
* 1937M-07	16		65,00	1	019370107
1937M-08	13	07	23,60	1	019370108
1937M-09	26	07	23,60	1	019370109
1937M-10	11	03, 05	23,60	1	019370110
1937M-11	23	01, 02, 04, 06	23,60	1	019370111

* Os preços indicados são para 6 unidades

1937N10

Lixadeira de cinta pneumática, 10 mm

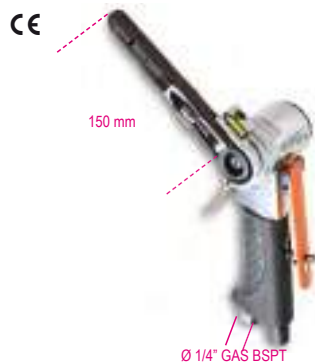

Rotações em vazio	20,000 rpm
Potência	0,37 kW
Dimensões da cinta	10x330 mm
Entrada de ar	1/4" GAS
Pressão de trabalho	6,2 bar
(Ø) interno do tubo	10 mm
Consumo médio de ar	374 l/min
Peso	0,9 kg

kg	€		
0,9	282,00	1	019370041

1937N10-GR

cinta para ref. 1937N10



	P	€		
1937N10-GR60	60	29,50	1	019370146
1937N10-GR80	80	29,50	1	019370148
1937N10-GR100	100	29,50	1	019370150
1937N10-GR120	120	29,50	1	019370152

Os preços indicados são para 10 unidades

1937N20

lixadeira pneumática de cinta 20 mm



Rotações em vazio	16,000 rpm
Potência	0,45 kW
Tamanho da cinta	20x520 mm
Entrada de ar	1/4" GAS
Pressão de trabalho	6,2 bar
(Ø) interno do tubo	10 mm
Consumo médio de ar	400 l/min
Peso	1,6 kg

kg	€		
1,6	328,00	1	019370051

1937N20-GR

cinta para ref. 1937N20



	P	€		
1937N20-GR60	60	39,00	1	019370156
1937N20-GR80	80	39,00	1	019370158
1937N20-GR100	100	39,00	1	019370160
1937N20-GR120	120	39,00	1	019370162

Os preços indicados são para 10 unidades

1938

Removedor de pára-brisas

• Fornecido com 1 espátula plana 57 mm

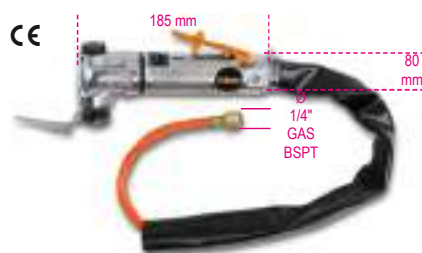

Oscilações/minuto	20,000
Entrada de ar	1/4" GAS
Pressão de trabalho	6,2 bar
Ø interno do tubo	6,5 mm
Consumo médio de ar	200 l/min
Peso	1,0 kg

kg	€		
1,0	221,00	1	019380021

1938R/L

espátulas para removedor de pára-brisas



	L mm	€		
1938R/L1	57	18,80	1	019380041
1938R/L2	90	34,50	1	019380042
1938R/L3	30	21,00	1	019380043
1938R/L4	8	29,50	1	019380044
1938R/L5	36	34,00	1	019380045

1938R/S5

jogo de 5 espátulas para item 1938

kg	€		
1938R/S5	138,00	1	019380055

1940

martelo burilador pneumático

• Fornecido com mola de fixação e retentor de segurança para buris sextavados



Golpes por minuto	3,500
Encaixe do buril	Ø 11 mm
Dimensões do pistão	19 mm
Curso do pistão	67 mm
Entrada de ar	1/4" GAS
Pressão de trabalho	6,2 bar
Ø interno do tubo	8 mm
Consumo médio de ar	240 l/min
Peso	1,9 kg

kg	€		
1,9	178,00	1	019400001

1940/C6

martelo pneumático com 5 escopros e acessórios

- Para cortar chapa metálica, ferrolhos e peças, remoção de escória de soldadura, rebites, gesso e azulejos
- Jogo fornecido em estojo de ferramentas ABS incluindo:
 - 1 martelo pneumático item 1940
 - 1 escopro plano item 1940SN
 - 1 escopro de demolição item 1940ST
 - 1 escopro ponta redonda item 1940SD
 - 1 escopro biselado item 1940SPS
 - 1 escopro corte de chapa 1940SDT
 - 1 mola de não-retorno item 1940MT
 - 1 retenção de baioneta para escopros sextavados



Impactos por minuto	3,500
Encabouro do escopro	Ø 11 mm
Dimensão do pistão	19 mm
Curso do pistão	67 mm
Entrada de ar	1/4" GAS
Pressão de trabalho	6,2 bar
Ø interno do tubo	8 mm
Consumo médio de ar	240 l/min
Peso	3,3 kg

kg	€		
3,3	252,00	1	019400000
320x240x90 mm			

1940MT

mola de fixação para refª. 1940



1940MT	€ 11,60	5	019400110
--------	---------	---	-----------

1940S...

buris para martelo 1940



1940SN	€ 14,30	5	019400020
1940ST	€ 14,30	5	019400021
1940SD	€ 14,30	5	019400022
1940SPS	€ 14,30	5	019400023
1940SDT	€ 14,30	5	019400024

1940/S5

jogo de 5 buris para 1940



1940/S5	€ 65,00	1	019400030
---------	---------	---	-----------

1940E10

martelo pneumático

- Compatível com escopros com encabadouro 10 mm sextavado
- Fornecido com mola e encabadouro de baioneta



Impactos por minuto	2.900
Encabadouro do escopro	○ 10 mm
Dimensão do pistão	19 mm
Curso do pistão	67 mm
Entrada de ar	1/4" GAS
Pressão de trabalho	6.2 bar
Ø interno do tubo	10 mm
Consumo médio de ar	76 l/min
Peso	1.7 kg

kg 1,7	€ 196,00	1	019400010
--------	----------	---	-----------

1940E10/MT

mola de retenção sobresselente para artigo 1940E10



1940E10/MT	€ 1,53	5	019400112
------------	--------	---	-----------

1940E10/S...

escopros para martelos pneumáticos 1940E10



1940E10/SN	€ 9,90	5	019400040
1940E10/ST	€ 9,90	5	019400041
1940E10/SD	€ 9,90	5	019400042
1940E10/SPS	€ 9,90	5	019400043
1940E10/SDT	€ 9,90	5	019400044

1940E10/S5

jogo de 5 escopros para martelos pneumáticos 1940E10



1940E10/S5	€ 49,50	1	019400050
------------	---------	---	-----------

1942A

serra pneumática



Oscilações por minuto	10.000
Curso	10 mm
Entrada de ar	1/4" GAS BSP
Pressão de trabalho	6.2 bar
Ø interno do tubo	8 mm
Consumo médio de ar	75 l/min
Peso	550 g

kg 550	€ 295,00	1	019420000
--------	----------	---	-----------

1942LR

lâminas bimetel para serra pneumática 1942A



1942LR	€ 6,90	5	019420032
--------	--------	---	-----------

1944A

martelo de agulhas axial



Impactos por minuto	3.800
Alcance	33 mm
Nº de agulhas	19
Dimensões da agulha (Ø)	3 mm
Entrada de ar	1/4" GAS
Pressão de trabalho	6.2 bar
Dimensão interna do tubo (Ø)	10 mm
Consumo de ar	85 l/min
Peso	2.8 kg

kg 2,8	€ 333,00	1	019440011
--------	----------	---	-----------

1944N

Martelo de agulhas



Impactos por minuto	3800
Comprimento	33 mm
Nº de agulhas	19
Tamanho da agulha (Ø)	3 mm
Entrada de ar	1/4" GAS
Pressão de trabalho	6.2 bar
Tamanho interno da mangueira (Ø)	8 mm
Consumo de ar	85 l/min
Peso	2.7 kg

kg 2,7	€ 425,00	1	019440002
--------	----------	---	-----------

1944AR

jogo de agulhas para martelo de agulhas refª. 1944N, 1944A



1944AR 2	Ø 2 mm	n. 29	€ 43,50	1	019440015
1944AR 3	Ø 3 mm	n. 19	€ 34,00	1	019440005

1944PA

Placas de agulha para itens 1944N e 1944A



	Ø mm	N.	€		
1944PA 2	2	29	48,00	1	019440016
1944PA 3	3	19	36,50	1	019440006

1945S

Agrafadora

• Agrafes tipo 80, seção comprimento de 0.95 x 0.65 mm (tamanho 21); 4-16 mm; largura: 12,8 mm



Capacidade	157 unid.
Entrada de ar	1/4" GAS
Pressão de trabalho	4.2 - 7 bar
Tamanho interno da mangueira (Ø)	8 mm
Consumo de ar (7 bar)	0,34 l/cycle
Peso	0,87 kg

kg	€		
0,9	181,00	1	019450000

1945S/G...

agrafes tipo 80, seção 0.95x0.65 mm (calibre 21), largura 12.8 mm, para item 1945S



	L mm	€		
• 1945S/G 4	4	16,90	1	019450004
1945S/G 6	6	6,70	1	019450006
1945S/G 8	8	7,20	1	019450008
1945S/G 10	10	8,10	1	019450010
1945S/G 12	12	9,00	1	019450012
1945S/G 14	14	9,70	1	019450014
1945S/G 16	16	10,70	1	019450016

Os preços indicados referem-se a 5.000 unid.
• Os preços indicados referem-se a 10.000 unid.

1945C

Pistola para agrafes e pregos combinada

• Agrafes tipo 90, seção 1,25 x 1,0 mm (calibre 18), comprimento: 16 - 40 mm; largura: 5,8 mm
• Pregos de cabeça redonda tipo B12, seção 1,25 x 1,0 mm (calibre 18), cabeça de 1,9 mm



Capacidade	100 unid.
Entrada de ar	1/4" GAS
Pressão de trabalho	5 - 8 bar
Tamanho da mangueira interna (Ø)	8 mm
Consumo de ar (7 bar)	1.12 l/cycle
Peso	1.16 kg

kg	€		
1,16	239,00	1	019450200

1945C/G...

agrafes tipo 90, seção 1.25x1.0 mm (calibre 18), largura 5.8 mm, para item 1945C



	L mm	€		
1945C/G 16	16	12,90	1	019450216
1945C/G 19	19	15,10	1	019450219
1945C/G 22	22	16,60	1	019450222
1945C/G 25	25	19,60	1	019450225
1945C/G 28	28	20,60	1	019450228
1945C/G 32	32	24,00	1	019450232
1945C/G 35	35	26,00	1	019450235
1945C/G 38	38	29,00	1	019450238
1945C/G 40	40	30,50	1	019450240

Os preços indicados referem-se a 5.000 unid.

1945C/GP...

pregos tipo B12, seção 1.25x1.0 mm (calibre 18), cabeça 1.9 mm, para item 1945C



	L mm	€		
1945C/GP 15	15	6,80	1	019450255
1945C/GP 16	16	7,00	1	019450256
1945C/GP 20	20	8,10	1	019450260
1945C/GP 25	25	9,50	1	019450265
1945C/GP 30	30	11,00	1	019450270
1945C/GP 32	32	12,20	1	019450272
1945C/GP 35	35	13,00	1	019450275
1945C/GP 38	38	14,10	1	019450278
1945C/GP 40	40	14,50	1	019450280
1945C/GP 45	45	16,10	1	019450285
1945C/GP 50	50	17,70	1	019450290

Os preços indicados referem-se a 5.000 unid.



1945P

Pistola para pinos

• Utiliza pinos tipo B6, Ø 0.64 mm (tamanho 23), comprimento: 12 - 35 mm



Capacidade	145 unid.
Entrada de ar	1/4" GAS
Pressão de trabalho	4 - 7 bar
Tamanho interno da mangueira (Ø)	8 mm
Consumo de ar (7 bar)	0,27 l/cycle
Peso	0,87 kg

kg	€		
0,87	289,00	1	019450100

1945P/S...

pinos tipo B6, Ø 0.64 mm (calibre 23), para item 1945P



	L mm	€		
1945P/S 12	12	7,90	1	019450112
1945P/S 15	15	8,60	1	019450115
1945P/S 18	18	9,40	1	019450118
1945P/S 20	20	10,90	1	019450120
1945P/S 21	21	11,00	1	019450121
1945P/S 22	22	11,40	1	019450122
1945P/S 25	25	12,20	1	019450125
1945P/S 30	30	13,90	1	019450130
1945P/S 35	35	15,80	1	019450135

Os preços indicados referem-se a 10.000 unid.



1946

rebitadora pneumática

- Fornecida com rebites e bicos intermutáveis de 2,4 - 3,2 - 4,0 - 4,8 mm

CE



Potência de tracção	8000 N
Curso	14 mm
Capacidade máx. rebite	Ø alumínio 4,8 mm
Entrada de ar	1/4" GAS
Pressão de trabalho	6,2 bar
(Ø) interno do tubo	6 mm
Consumo médio de ar	1,2 l/ciclo
Peso	1,5 kg

kg	€		
1,5	180,00	1	019460001

1946C4,8

rebitadora

- Entrada de ar automática
- Fornecida montada para utilização com rebites de aço, aço inoxidável, alumínio e cobre com 2.4 - 3.2 - 4.0 - 4.8 mm

CE



Potência de tracção	8,900 N
Extensão do curso	15 mm
Capacidade máx. do rebite	Aço inoxidável Ø 4.8 mm
Entrada de ar	1/4" GAS
Pressão de trabalho	6,2 bar
Dimens. interna do tubo (Ø)	10 mm
Consumo de ar	2.6 l/ciclo
Peso	1.5 kg

kg	€		
1,5	560,00	1	019460006

1946C7,8

rebitadora

- Entrada de ar automática
- Fornecida montada para utilização com rebites de aço, aço inoxidável, alumínio e cobre com 4.8 - 5.6 - 6.4 - 7.8 mm

CE



Potência de tracção	16,900 N
Extensão do curso	22.5 mm
Capacidade máx. do rebite	Aço inoxidável Ø 7.8 mm
Entrada de ar	1/4" GAS
Pressão de trabalho	6,2 bar
Dimens. interna do tubo (Ø)	10 mm
Consumo de ar	4.9 l/ciclo
Peso	1.8 kg

kg	€		
1,8	885,00	1	019460008

1946C/T...

Cabeças de rebites



	Ø mm	€		
1946C/T4,8	4,8	34,00	1	019460016
1946C/T6,4	6,4	34,00	1	019460018

1946KF

rebitadora pneumática para rebites roscados

- Fornecida montada para rebites roscados em aço, aço inox, alumínio e cobre, M4, M5, M6, M8

CE



Força de tracção	14,235 N
Curso	7 mm
Capacidade máxima rebite	Aço inox Ø, M8
Entrada de ar	1/4" GAS
Pressão de trabalho	6,2 bar
Ø interno do tubo	10 mm
Consumo de ar	2.1 l/ciclo
Peso máquina	2.1 kg
Peso kit	3.4 kg

kg	€		
3,4	1.860,00	1	019460012

1946KF/M...

bicos de substituição para rebitadora ref. 1946KF



	€		
1946KF/M4	62,50	1	019460124
1946KF/M5	62,50	1	019460125
1946KF/M6	62,50	1	019460126
1946KF/M8	60,00	1	019460128

1947

pistola de colagem

- Pistola pneumática para silicone de média densidade, adesivo e cola
- Adequada para bastões standard (210 x 50 mm), duros e macios

CE



Dimensões do tubo	210x50 mm
Capacidade do cartucho	350 ml
Entrada de ar	1/4" GAS
Pressão de trabalho	4.8 bar
(Ø) interno do tubo	10 mm
Consumo médio de ar	120 l/min
Peso	1,1 kg

kg	€		
1,1	63,00	1	019470001

1947H

pistola para isolantes

- Pistola pneumática para silicone e isolantes em cartuchos standard de plástico ou alumínio
- Suporta cartuchos standard (215/218 mm x 50/51 mm), rígidos e moles
- Válvula de redução da pressão integrada

CE



Dimensões do tubo	210x50 mm
Capacidade do cartucho	300/310 ml
Entrada de ar	1/4" GAS
Pressão de trabalho	4 + 8 bar
(Ø) interno do tubo	2.5 mm
Consumo médio de ar	120 l/min
Peso	750 g

g	€		
750	219,00	1	019470011



1947G

bomba de massa pneumática, com extensão e bico

Estrutura robusta em alumínio fundido
Punho ergonómico com inclinação perfeita para trabalhar em espaços apertados
Válvula em latão para maior vida útil
Capacidade: 500cc ou cartuchos de 400g
Dimensões do tubo: 54 (interior) x 260 mm
Entrada de ar: 1/4" GAS
Pressão de trabalho: 4÷10 bar
Peso: 1.9 kg



1947G € 155,00 1 019470051

1947G2

pistola de massa 2 em 1

Para fornecimento contínuo e não contínuo
Cabeça em alumínio fundido
Punho ergonómico
Capacidade para cartuchos de 400 g ou massa até 500 cc



Dimensão do tubo 54 (interior) x 276 mm
Entrada de ar 1/4" GAS BSP
Pressão de trabalho 3÷10 bar
Peso 2,2 kg

1947G2 € 159,00 1 019470060

1948

caneta de gravação

• Permite a gravação em aço, aço inox, alumínio, vidro, pedra e cerâmica



Golpes por minuto 3,500 ÷ 3,800
Dureza máxima 60 HRC
Entrada de ar 1/4" GAS
Pressão de trabalho 6.2 bar
Consumo médio de ar 50 l/min
Peso 150 g

1948 € 290,00 1 019480001

1948PR

ponta pastilhada em tungsténio para item 1948

• Dureza máx.: 60 HRC



1948PR € 110,00 1 019480005

1949XS

soprador progressivo

• Em liga leve
• O fluxo de ar pode ser ajustado através da rotação da cabeça



Rosca 1/4" GAS
Pressão de trabalho 3-8 bar
Pressão máx. de trabalho 10 bar
Temperatura de trabalho -20 °C ÷ 70 T38°C
Peso 20 g

1949XS € 6,30 25 019490025

1949U5

soprador progressivo com 5 bicos

• Em material compósito anti-desgaste, à prova de embates
• 3 bicos em aço, 100/160/320 mm, pontas protetoras em borracha anti-riscos
• 1 bico "Turbo" em nylon reforçado com fibra de vidro com ponta de segurança
• 1 bico giratório, 100 mm, em nylon reforçado com fibra de vidro
• Com sistema de fixação rápida



Insert roscado em latão 1/4" GAS
Pressão de trabalho 10 bar
Pressão de trabalho máx. 15 bar
Consumo médio de ar 280 l/min
Temperatura de trabalho -10°C ÷ 85°C
Peso 93 g

1949U5 € 34,50 1 019490030

1949U5/A

bico em aço, 100 mm, com ponta protetora em borracha anti-riscos, para item 1949U5 - 1949P



1949U5/A € 7,00 1 019490131

1949U5/B

bico em aço, 160 mm, com ponta protetora em borracha anti-riscos, para item 1949U5 - 1949P



1949U5/B € 7,10 1 019490132

1949U5/C

bico em aço, 320 mm, com ponta protetora em borracha anti-riscos, para item 1949U5 - 1949P



1949U5/C € 9,10 1 019490133

1949U5/D

bico giratório, 100 mm, em nylon reforçado com fibra de vidro, para item 1949U5 - 1949P



1949U5/D € 6,70 1 019490134

Beta

1949U5/E

bico "Turbo" em nylon reforçado com fibra de vidro, com ponta de segurança



1949U5/E € 3,25 1 019490135

1949U5/F

bico plano, em forma de leque, em nylon reforçado com fibra de vidro, para itens 1949U5 e 1949P



1949U5/F € 4,20 1 019490136

1949U5/G

bico OSHA, em nylon reforçado com fibra de vidro, para itens 1949U5 e 1949P



1949U5/G € 3,15 1 019490137

1949BC

soprador progressivo com bico em borracha

- Corpo em material composto, anti-choque
- Bico substituível em borracha

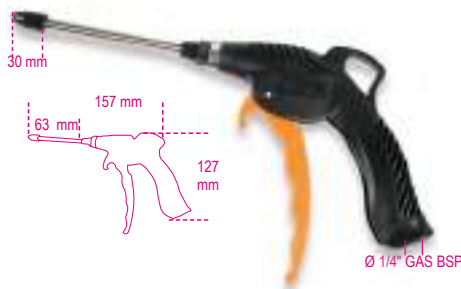

Insert roscado em latão 1/4" GAS
 Pressão de trabalho 6-8 bar
 Pressão de trabalho máx. 15 bar
 Consumo médio de ar 87 l/min
 Temperatura de trabalho -20°C ÷ 70°C
 Peso 120 g

120 g € 17,00 1 019490022

1949BC/RUL

5 bicos em borracha longos, para artigo 1949BC



1949BC/RUL € 21,00 1 019490123

1949P

mini soprador progressivo

- Em material composto anti-desgaste, à prova de embates
- Sistema de fixação rápida do bico
- O fluxo de ar pode ser ajustado por rotação da porca

Ø 1/4" GAS BSPT



Insert roscado em latão 1/4" GAS
 Pressão de trabalho 6-8 bar
 Pressão de trabalho máx. 15 bar
 Consumo de ar médio 280 l/min
 Temperatura -10 °C ÷ 85 °C
 Peso 70 g

70 g € 22,30 1 019490031

1949T

soprador progressivo telescópico

- Corpo em material composto, anti-desgaste e anti-choque
- Tubo telescópico giratório em aço: 165 mm ÷ 300 mm

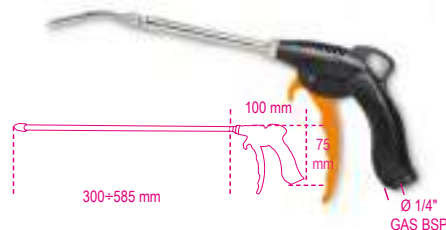

Insert roscado em latão 1/4" GAS
 Pressão de trabalho 6-8 bar
 Pressão de trabalho máx. 15 bar
 Consumo médio de ar 144 l/min
 Pressão de trabalho -20°C ÷ 70°C
 Peso 190 g

190 g € 27,00 1 019490040



1949F2

pistola de ar progressiva

- Em plástico composto resistente, anti-impacto, à prova de riscos, com isolamento térmico
- Válvula e alavanca especial que permitem a abertura progressiva do circuito, otimizando o fluxo de ar
- Ponta com cone de segurança em plástico para manuseamento seguro quando não se encontra em funcionamento



Insertão roscada em bronze 1/4" GAS
 Pressão de trabalho 4-8 bar
 Pressão de trabalho máxima 12 bar
 Temperatura de trabalho -20 °C ÷ 70 °C
 Peso 125 g

125 g € 15,70 1 019490028

1949GPA

pinho de encher pneus

- corpo revestido a borracha anti-impacto
- alavanca de operação em metal
- pressão de trabalho: 0,5÷12 bar, 7÷174 psi
- botão despressurização
- dispositivo medição pressão
- comprimento do tubo: 58 cm
- rotação do tubo 360°
- entrada de ar 1/4"



1949GPA bar psi € 101,00 1 019490018 0,5÷12 7÷174



1949DGT/2

punho de encher pneus digital

- corpo revestido a borracha anti-impacto
- alavanca de operação em metal
- pressão de trabalho: 0,5÷12 bar, 7÷174 psi
- 4 unidades de medida, bar/psi/kpa/kgf
- monitor LCD iluminado
- resolução: 0.05 bar
- funcionamento automático desliga após 1.5 minuto
- comprimento do tubo: 58 cm
- rotação do tubo 360°
- alimentação: 2 pilhas AAA
- entrada de ar 1/4"

CE



1949DGT/2 $\frac{\text{bar}}{0,5\div 12}$ $\frac{\text{psi}}{7\div 174}$ € 120,00 1 019490021

1949GPN

punho de encher pneus, caixa em ABS

- Manómetro de pressão com certificação CE e escala 0.7÷12 bar (graduada a 1/10 bar)
- Dois botões de comando para enchimento preciso e rápido (+) e para esvaziar (-)
- Fornecido com certificado de calibragem
- Inclui resguardo de protecção anti-impacto e visor
- Equipado com união roscada 1/4" GAS
- Entrada de ar giratória para tubo em borracha, Ø 7 mm

CE



1949GPN $\frac{\text{bar}}{0,7\div 12}$ $\frac{\text{g}}{810}$ € 199,00 1 019490011

1949M

punho para medir a pressão dos pneus



1949M $\frac{\text{bar}}{0\div 4}$ $\frac{\text{psi}}{5\div 60}$ $\frac{\text{g}}{280}$ € 70,50 1 019490400

1949R

pistola de ar para limpeza de radiadores os 5 furos perpendiculares ao punho permitem a remoção de sujidade dos radiadores



L mm 600 $\frac{\text{mm}}{6}$ € 79,50 1 019490050

1950BZK

destalonador de pneus

- punho secundário com operação por botão ajuda a segurar a ferramenta durante a utilização
- capacidade do depósito: 18 l
- pressão de funcionamento: 3-8 bar
- pressão máxima do depósito: 16 bar
- válvula de alívio de pressão
- medidor com escala graduada
- entrada de plástico para evitar danos na jante

CE



1950BZK € 363,00 1 019500078



1951

pistola de limpeza

- Para limpeza de estofos, tapetes e assentos de automóveis e botas



Capacidade do reservatório 1 L
Entrada de ar 1/4" GAS
Pressão de trabalho 6,2 bar
Ø interno do tubo 8 mm
Consumo médio de ar 110 l/min
Peso 650 g

$\frac{\text{g}}{650}$ € 137,00 1 019510051

1951A

pistola de limpeza com aspiração

- Para limpeza de estofos, tapetes e assentos de automóveis e botas
- Para utilização com detergentes adequados
- Reservatório de 1L
- Equipada com torneira para dispensar líquido do reservatório
- Equipada com tubo corrugado, 1,8 m de comp.



Capacidade do reservatório 1 l
Entrada de ar 1/4" GAS
Pressão de trabalho 6.2 bar
Ø interno do tubo 8 mm
Consumo médio de ar 120 l/min
Peso 800 g

$\frac{\text{g}}{800}$ € 221,00 1 019510101

1952

pistola de pintura profissional

- Corpo em alumínio fundido com revestimento niquelado preto
- Reservatório nylon com dispositivo antigota, rosca BSP 3/8M
- Rosca corpo: rosca cilíndrica de gás 1/4" BSP
- Regulador de pressão e fluxo de ar
- Regulador do jato de pulverização, redondo ou em leque
- Regulador da quantidade de tinta
- Fornecido com chave de serviço para operações de manutenção

CE



	Ø mm	€		
1952 1,2	1,2	146,00	1	019520012
1952 1,5	1,5	146,00	1	019520015
1952 1,8	1,8	146,00	1	019520018
1952 2,0	2,0	146,00	1	019520020

1900S

enrolador de tubo automático, corpo em plástico anti-impacto, para utilização com ar comprimido ou água

- pressão máx. de funcionamento: 15 bar
- tubo de poliuretano
- estrutura em polipropileno
- dispositivo para fixar automaticamente o tubo no comprimento necessário
- mecanismo de cremalheira pode ser desativado para manter o cabo puxado
- amplitude de temperatura: -5 °C / +50 °C
- fornecido com suporte giratório 180° e um suporte adicional de ligação rápida

CE



D1xD	L	Ø GAS	€		
mm	m	BSP			
1900S 8X10	8x12	1/4"	194,00	1	019000080

1900M

enrolador de tubo automático, corpo em plástico anti-impacto, para utilização com ar comprimido ou água

- pressão máx. de funcionamento: 15 bar
- tubo em poliuretano
- corpo em polipropileno
- dispositivo para fixar automaticamente o tubo no comprimento necessário
- mecanismo de cremalheira pode ser desativado para manter o tubo puxado
- amplitude de temperatura: -5 °C / +50 °C
- fornecido com suporte giratório 180° e um suporte adicional de ligação rápida

CE



D1xD	L	Ø GAS	€		
mm	m	BSP			
1900M 8X15	8x12	15 1/4"	265,00	1	019000085
1900M 10X15	10x14	15 3/8"	276,00	1	019000115

1914

tubo espiral em poliuretano, 98 Shore, extensível

- Pressão de trabalho máxima: 12 bar



L	D1xD	Ø GAS	€		
m	mm	BSP			
4	5x8	1/4"	23,20	1	019140054
6	5x8	1/4"	27,00	1	019140056
10	5x8	1/4"	34,50	1	019140060

1915B

tubo espiral em poliuretano, 95 Shore, extensível até 9 m

- Pressão de trabalho máxima: 10 bar

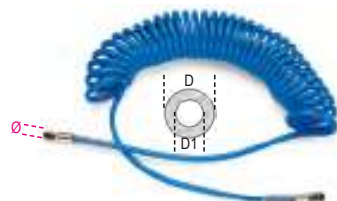

D1xD	Ø GAS	€		
mm	BSP			
6,5x10	1/4"	39,50	1	019150011
8x12	1/4"	47,50	1	019150012

1915C

tubo espiral em poliuretano, 95 Shore, extensível até 12 m

- Pressão de trabalho máxima: 10 bar

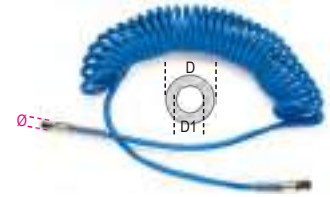

D1xD	Ø GAS	€		
mm	BSP			
6,5x10	1/4"	47,50	1	019150014
8x12	1/4"	58,50	1	019150015

1915C/L

tubo espiral em poliuretano, 95 Shore, extensível até 15 m

- Pressão de trabalho máxima: 10 bar

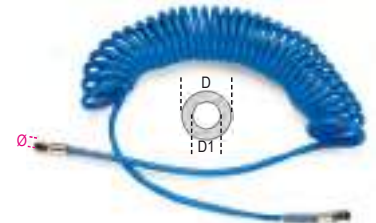

D1xD	Ø GAS	€		
mm	BSP			
8x12	1/4"	75,00	1	019150115
11x16	3/8"	127,00	1	019150116

1915D

tubo em poliuretano, 95 Shore, com 9 m

- Pressão de trabalho máxima: 15 bar



D1xD	Ø GAS	€		
mm	BSP			
8x12	1/4"	47,50	1	019150017

1915E

tubo em poliuretano, 95 Shore, com 12 m

- Pressão de trabalho máxima: 15 bar



D1xD	Ø GAS	€		
mm	BSP			
8x12	1/4"	63,00	1	019150019
11x16	3/8"	94,00	1	019150020

1915E/XL

tubo em poliuretano, 95 Shore, com 50 m

• Pressão de trabalho máxima: 15 bar



D1xD mm	Ø GAS BSP	€	🔧	📦
8x12	1/4"	216,00	1	019150519
11x16	3/8"	362,00	1	019150520

1916I

uniões rápidas de perfil italiano
rosca macho, cilíndricas (BSP)



Ø GAS BSP	€	🔧	📦
1/4"	2,74	5	019160001
3/8"	3,10	5	019160002

1916G

uniões rápidas de perfil europeu
rosca macho, afuniladas (BSPT)



Ø GAS BSPT	€	🔧	📦
1/4"	2,74	5	019160005
3/8"	3,60	5	019160010
1/2"	4,00	5	019160012

1916GF

Engates rápidos, perfil europeu, rosca fêmea,
cônico (BSPT)



Ø GAS BSP	€	🔧	📦
1/4"	2,74	5	019160055
3/8"	3,10	5	019160060

1916GFE

uniões rápidas, perfil Europeu,
rosca fêmea, afunilada (BSPT)



Ø GAS BSPT	€	🔧	📦
1/4"	2,74	5	019160075
3/8"	3,60	5	019160082
1/2"	4,00	5	019160084

1916JM

Engates rápidos de perfil asiático, rosca
macho cônica (BSPT)



Ø GAS BSPT	€	🔧	📦
1/4"	3,85	1	019160406
3/8"	4,00	1	019160410

1916JF

Engates rápidos, perfil europeu, rosca fêmea,
cilíndrico (BSP)



Ø GAS BSPT	€	🔧	📦
1/4"	3,85	1	019160456
3/8"	4,00	1	019160460

1916P

uniões rápidas, perfil Italiano,
com encaixe para mangueira de borracha



D1xD mm	€	🔧	📦
6x14	3,60	5	019160256
8x17	3,90	5	019160258
10x19	5,30	5	019160260

1916S

uniões rápidas, perfil Italiano, com molas
espirais



D1xD mm	€	🔧	📦
6x8	3,60	5	019160306
8x10	3,85	5	019160308
10x12	4,90	5	019160310

1917M

uniões de esferas universais,
borracha à prova de impacto,
rosca macho, cilíndricas (BSP)

• Adequadas para uniões 1916I e 1916G



Ø GAS BSP	€	🔧	📦
1/4"	9,90	5	019170001
3/8"	9,90	5	019170003
1/2"	10,60	5	019170004

1917F

Engates rápidos de esfera universal com
borracha à prova de choque e fêmea com
rosca cilíndrica (BSP)

• Engates 1916I e 1916G



Ø GAS BSP	€	🔧	📦
1/4"	10,30	5	019170005
3/8"	9,90	5	019170010
1/2"	10,90	5	019170014

1917JM

Engates rápidos de esferas, perfil asiático,
rosca macho, cilíndrica (BSP)



Ø GAS BSP	€	🔧	📦
1/4"	16,40	1	019170406
3/8"	16,40	1	019170410
1/2"	17,70	1	019170412

1917JF

Engates rápidos de esferas, perfil asiático,
rosca fêmea, cilíndrica (BSP)



Ø GAS BSP	€	🔧	📦
1/4"	16,40	1	019170456
3/8"	16,40	1	019170460

1917RG

Engate universal rotativo

- Fabricado em alumínio, rosca fêmea, cilíndrica (BSP) rosca macho, cilíndrica (BSP)
- Combina todos os engates com perfis italianos e europeus
- Gira livremente, mesmo sem área conectada



Ø GAS BSP	€	🔧	📦
1/4"	21,40	1	019170252

1917SP

uniões rápidas de esfera universal, com encaixe para mangueira de borracha



D1xD	mm	€	🔧	📦	
6x14		10,60	5	019170206	
8x17		11,00	5	019170208	
10x19		12,60	5	019170210	

1917ST

uniões rápidas de esfera universal, com molas espirais



D1xD	mm	€	🔧	📦	
6x8		9,90	5	019170306	
8x10		10,00	5	019170308	
10x12		11,30	5	019170310	

1918

Adaptador extremidade da mangueira, rosca macho



D1	Ø GAS	mm	BSP	€	🔧	📦	
6	1/8"			2,19	3	019180106	
8	1/8"			2,19	3	019180108	
6	1/4"			2,39	3	019180116	
8	1/4"			2,52	3	019180118	
10	1/4"			2,52	3	019180120	
10	3/8"			2,87	3	019180130	
12	3/8"			2,96	3	019180132	
10	1/2"			3,90	3	019180140	
12	1/2"			4,00	3	019180142	

1918N

uniões roscadas (BSPT)



Ø	Ø1	GAS	GAS	€	🔧	📦	
1/4"	1/4"			2,52	5	019180300	
3/8"	3/8"			2,96	5	019180310	
1/2"	1/2"			4,00	5	019180320	

1918R

uniões redutoras roscadas (BSPT)



Ø	Ø1	GAS	GAS	€	🔧	📦	
1/4"	3/8"			2,87	5	019180200	
3/8"	1/2"			3,90	5	019180210	

1919FE1/4

filtro regulador lubrificador



Entrada/saída de ar	1/4" GAS BSPT
Entrada manómetro de pressão	1/8" GAS BSPT
Capacidade pneumática máx.	750 l/min
Pressão máx.	9,5 bar
Pressão de trabalho	0,5 - 8,5 bar
Temperatura de trabalho	5 - 60 °C
Capacidade do filtro	5 micron
Capacidade recip.	15 cc ar / 25 cc óleo
Peso	700 g

📦	€	🔧	📦	
700	99,00	1	019190200	

1919RB-FE1/4

jogo de copos de substituição para artigo 1919FE1/4



1919RB-FE1/4	€	🔧	📦	
	21,50	1	019190210	

1919RF-FE1/4

elemento filtrante de substituição para artigo 1919FE1/4



1919RF-FE1/4	€	🔧	📦	
	5,90	1	019190230	

1919RM-FE1/4

manómetro de substituição para artigo 1919FE1/4



1919RM-FE	€	🔧	📦	
	12,70	1	019190220	

1919F1/4

filtro regulador lubrificador



Entrada/saída de ar	1/4" GAS BSPT
Capacidade pneumática máx.	1000 l/min
Pressão máx.	9,5 bar
Pressão de trabalho	0,5 - 8,5 bar
Temperatura de trabalho	5 - 60 °C
Capacidade do filtro	5 microns
Capacidade recip.	60 cc ar / 90 cc óleo
Peso	1,3 kg

📦	€	🔧	📦	
1,3	156,00	1	019190250	

1919F3/8

filtro regulador lubrificador



Entrada/saída de ar 3/8" GAS BSPT
 Capacidade pneumática máx. 1350 l/min
 Pressão máx. 9,5 bar
 Pressão de trabalho 0,5 - 8,5 bar
 Temperatura de trabalho 5 - 60 °C
 Capacidade do filtro 5 microns
 Capacidade recip. 60 cc ar / 90 cc óleo
 Peso 1.3 kg

kg 1,3 € 156,00 1 019190350

1919F1/2

filtro regulador lubrificador



Entrada/saída de ar 1/2" GAS BSPT
 Capacidade pneumática máx. 2500 l/min
 Pressão máx. 9,5 bar
 Pressão de trabalho 0,5 - 8,5 bar
 Temperatura de trabalho 5 - 60 °C
 Capacidade do filtro 5 microns
 Capacidade recip. 60 cc ar / 90 cc óleo
 Peso 1.3 kg

kg 1,3 € 156,00 1 019190450

1919RB-F

jogo de copos de substituição para artigos 1919F - 1/4", 3/8" e 1/2"



€ 27,50 1 019190510

1919RF-F

elemento filtrante de substituição para artigos 1919F - 1/4", 3/8" e 1/2"



€ 10,90 1 019190530

1919RM-F

manómetro de substituição para artigos 1919F - 1/4", 3/8" e 1/2"



€ 16,40 1 019190520

1919ML

mini lubrificador de linha



Ø	L	Ø	€	1	019190030
1/4"	63	36	20,10	1	019190030
3/8"	63	36	21,80	1	019190032

1919SC

mini separador de condensados



Ø	L	Ø	€	1	019190035
1/4"	80	40	26,00	1	019190035

1919L

óleo de lubrificação ISO 32

Densidade a 20°C 875 Kg/m³
 Viscosidade 40°C 32 cSt
 Inflamabilidade COC 210°C



cc 500 € 17,70 5 019190050





JOGOS DE FERRAMENTAS, MALAS, CAIXAS E CARROS

			MALAS							CAIXAS												TOOL TROLLEY															
			2009N/BV	2028/VV	2029/VV	2032/TV	2033L/VV	2036/TV	C99	C99V1	C99V3/2C	C4	C5	C5S	C6T	C9MT	C7	C8	C10	C9	C10S	C11	CP15L	C16	CP17	CP17L	C12	C14	CP15	C18	C19	C19L	C20	C20L	C41S	C41H	C42H
pieces																																					
5914VU/M	Manutenção em geral	109																																			
5915VU/0	Manutenção em geral	35									498																										
5915VU/1	Manutenção em geral	45															498	498	498	498	498							498	498								
5915VU/2	Manutenção em geral	49										499																499			499	499					
5915VU/3	Manutenção em geral	74										499																		499	499	499					
5915VU/4	Manutenção em geral	80																												500	500						
5915VU/5	Manutenção em geral	111																									500						500	500	500	500	
5915VU/AS	Manutenção em geral	68																	501											501	501						
5940SBK	Reparação de motocicletas e bicicletas	125																															528	528	528		
5941VU/M	Manutenção em geral	64																																528	529		
5980EL/A	Electrónica	57		514		514	514																														
5980EL/B	Electrónica	98			515		515	515																													
5980ET/A	Electrotécnica	70		512		512																						512									
5980ET/B	Electrotécnica	64			513		513	513																				513									
5980ID/1	Canalização	24	516								516																										
5980MQ	Electrotécnica	46			513																																
5980U/BIKE	Reparação de motocicletas e bicicletas	90																																		506	
5990V1	Manutenção em geral	44							505	505																											
5990V3	Manutenção em geral	116							505		505																										

MOCHILAS E SACOS DE FERRAMENTAS EM TECIDO TÉCNICO

- **FUNCIONALIDADE**
- **ROBUSTEZ**
- **DURABILIDADE**

Estas são as pedras basilares da gama Beta de sacos e mochilas em tecido. As mochilas e sacos de ferramentas Beta são fabricados em tecido técnico resistente à abrasão e desgaste, com costuras e fundo reforçados, o que se traduz em durabilidade e fiabilidade.

Cada saco tem características especiais, concebidas para diferentes utilizações e otimização do espaço: bolsos com fecho de correr, pegas telescópicas, proteções das rodas, alças reforçadas e porta-documentos transparentes são apenas algumas das particularidades de cada saco e mochila.

A atenção aos detalhes, à variedade e ao transporte totalmente seguro das ferramentas garantem que estes produtos são ideais em qualquer situação de trabalho.



CAIXAS DE FERRAMENTAS EM POLIPROPILENO

A Beta oferece uma ampla gama de estojos para qualquer necessidade! Caixas e carros de ferramentas Beta são construídos em polipropileno robusto, compacto, à prova de embates, anti-corrosão, desenhados para suportar utilizações pesadas – por ex., a baixas temperaturas.

Escolha o melhor produto para as suas necessidades de trabalho, desde o

carro de ferramentas clássico, passando pela versão com rodas para fácil transporte, pelas versões com fechos TSA para liberdade total em viagem, até às versões em alumínio ou impermeáveis.

A maior parte das caixas e carros de ferramentas Beta estão disponíveis também em combinação com jogos de ferramentas para diferentes necessidades, em função do campo de aplicação: eletrónica, hidráulica, náutica e manutenção.



2001/B26

estojo de tecido com sortido de 26 ferramentas



2001/B26 € 261,00 1 020010215

55 6x7 - 8x9 - 10x11 - 12x13 - 14x15 - 16x17 mm
96N/SC9 1,5 - 2 - 2,5 - 3 - 4 - 5 - 6 - 8 - 10 mm
1128BMX 145 mm
1150 180 mm
1201E 3x75 - 4x100 - 5,5x150 mm
1202E PH1x80 - PH2x100 mm
1370 300 g
1692 2 m
1770A 9 mm

2001/BV € 62,00 1 020010051

2001/BZV

estojo de ferramentas em tecido técnico resistente

- Pega superior dupla para ótimo transporte
- Bolso frontal de grandes dimensões para documentos, com fecho
- Faixa de velcro na parte traseira, para fixação do estojo à pega do carro
- 20 compartimentos para ferramentas (6 bolsos e 14 bandas elásticas)
- Laçadas para martelo
- Disponível com alça de ombro C9/RT (a encomendar separadamente)



2001/BZV € 56,50 1 020010151

380x290x60 mm - 675 g



2001/BZ24 MQ

estojo dobrável com conjunto de 24 ferramentas, para eletricitas



2001/BZ24 MQ € 381,00 1 020010154

	n.
1128BMX	1
1150MQ 180 mm	1
42 8-10-13-17-19 mm	5
1274MQ 3x100 - 4x100 - 5,5x125 mm	3
1272MQ PH0x60 - PH1x80 - PH2x100 mm	3
96BP/SC9 1,5-2-2,5-3-4-5-6-8-10 mm	9
1253	1
1082MQ 160 mm	1

2001/BZ27 VU

estojo dobrável com conjunto de 27 ferramentas, para utilização universal



2001/BZ27 VU € 308,00 1 020010157

	n.
1128BMX	1
1150 180 mm	1
42 7-8-10-13-17-19 mm	6
1201E 3x75 - 4x100 - 5,5x150 mm	3
1202E PH0x60- PH1x80 - PH2x100 mm	3
96/SC9 1,5-2-2,5-3-4-5-6-8-10 mm	9
1370 300 g	1
1048N 250 mm	1
1692/5 5 m	1
1771 18 mm	1

2002/BV6

bolsa para ferramentas em poliéster, vazia

- Com 6 compartimentos para ferramentas de diferentes tamanhos
- Alça central em tecido reforçado facilita o transporte
- Com aba interior para evitar que as ferramentas saiam
- Costuras reforçadas em todo o perímetro
- Fecho duplo em Velcro
- Dimensões aberta: 175 x 240 mm



2002/BV6 € 10,00 1 020020000

2002/BVL6

bolsa para ferramentas em poliéster, vazia

- Com 6 compartimentos para ferramentas de diferentes tamanhos
- Alça central em tecido reforçado facilita o transporte
- Com aba interior para evitar que as ferramentas saiam
- Costuras reforçadas em todo o perímetro
- Fecho duplo em Velcro
- Dimensões aberta: 220 x 290 mm



2002/BVL6 € 12,70 1 020020010

2002/BV7-ZIP

bolsa para ferramentas em poliéster, vazia

- Com 7 compartimentos para ferramentas de diferentes tamanhos e pequeno bolso para ferramentas com fecho de correr
- Alça central em tecido reforçado facilita o transporte
- Com aba interior para evitar que as ferramentas saiam
- Costuras reforçadas em todo o perímetro
- Fecho duplo em Velcro
- Dimensões aberta: 355 x 220 mm



2002/BV7-ZIP € 22,70 1 020020060

2002/BV8

bolsa para ferramentas em poliéster, vazia

- Com 8 compartimentos para ferramentas de diferentes tamanhos
- Alça central em tecido reforçado facilita o transporte
- Com aba interior para evitar que as ferramentas saiam
- Costuras reforçadas em todo o perímetro
- Fecho duplo em Velcro
- Dimensões aberta: 395 x 360 mm



2002/BV8 € 12,70 1 020020020

2002/BV9

bolsa para ferramentas em poliéster, vazia

- Com 9 compartimentos para ferramentas de diferentes tamanhos
- Alça central em tecido reforçado facilita o transporte
- Com aba interior para evitar que as ferramentas saiam
- Costuras reforçadas em todo o perímetro
- Fecho duplo em Velcro
- Dimensões aberta: 325 x 290 mm



2002/BV9 € 12,70 1 020020030

2002/BV12

bolsa para ferramentas em poliéster, vazia

- Com 12 compartimentos para ferramentas de diferentes tamanhos
- Alça central em tecido reforçado facilita o transporte
- Com aba interior para evitar que as ferramentas saiam
- Costuras reforçadas em todo o perímetro
- Fecho duplo em Velcro
- Dimensões aberta: 650 x 355 mm



2002/BV12 € 21,10 1 020020040

2002/BV13

bolsa para ferramentas em poliéster, vazia

- Com 13 compartimentos para ferramentas de diferentes tamanhos
- Alça central em tecido reforçado facilita o transporte
- Com aba interior para evitar que as ferramentas saiam
- Costuras reforçadas em todo o perímetro
- Fecho duplo em Velcro
- Dimensões aberta: 330 x 190 mm



2002/BV13 € 12,70 1 020020050

2002/BV42

bolsa para ferramentas em poliéster resistente, vazia

- Com 42 compartimentos para ferramentas de diferentes dimensões:
 - 18 bandas elásticas e 24 bolsos, incluindo um com aba
- Pega central em tecido reforçado para fácil transporte
- Com anéis metálicos para suspensão
- Costuras de reforço em todo o perímetro da bolsa
- Fecho resistente com fivela dupla
- Dimensões aberta: 595 x 535 mm



2002/BV42 € 31,00 1 020020070

2005MPU

bolsa para ferramentas, vazia, em nylon, com cinto

- Cinco bolsos grandes para ferramentas
- Um bolso frontal para tesoura
- Fivela com gancho tipo carabina para fita adesiva
- Cinto ajustável (70 ÷ 120 cm)

Dimensões: 155x285x80 mm



2005MPU € 32,50 1 020050060

2005MPU/E

bolsa para ferramentas com sortido de 5 ferramentas



2005MPU/E € 104,00 1 020050065

1128BMX

1150BM 180 mm

1201E 3,5x100 - 4x100 mm

1202E PH1x80 mm

155x285x80 mm

2005PA/D

bolsa para ferramentas, vazia, em nylon, com cinto



2005PA/D € 77,00 1 020050000

2005PA/E

bolsa para ferramentas, vazia, em nylon, com cinto

- Dois bolsos grandes com elásticos para ferramentas
- Dois bolsos frontais para tesouras
- Dois compartimentos laterais com:
 - bolso esquerdo com gancho de metal resistente para fitas métricas
 - bolso direito duplo com bolsa com cordão e fecho de correr
- Fivela com gancho tipo carabina para fita adesiva
- Cinto ajustável (70 ÷ 120 cm)

Dimensões: 260x250x190 mm



2005PA/E € 51,50 1 020050030



2005PA/ET

bolsa para ferramentas com sortido de 8 ferramentas para manutenção eletrotécnica



2005PA/ET € 206,00 1 020050035

1082MQ 160 160 mm

1128BMX

1253

1272MQF PH1x80 - PH2x100

1274MQF 3,5x100 - 4,5x100

1639ESB BMESB1925NE

260x250x190 mm

2005PA/S

bolsa para ferramentas, vazia, em nylon, com cinto



2005PA/S € 38,50 1 020050020

2009N/BV

estojo de manutenção (vazio)



2009N/BV € 325,00 1 020090200

530x220x190 mm

2005PA/U

bolsa para ferramentas com sortido de 17 ferramentas para utilização universal



2005PA/U € 199,00 1 020050040

96/SC9

111E 200 mm

1048N 250 mm

1128BMX

1201E 4x100 - 5,5x125 mm

1202E PH1x80 - PH2x100 mm

1692/3 3 m

≡ 260x250x190 mm

2028/VV

Caixa de ferramenta, de polipropileno

2 painéis de ferramentas

Fundo interior com divisórias removíveis

Fechadura de combinação dupla



2028/VV € 269,00 1 020280010

≡ 480x190x400 mm

2028E

Mala com sortido de ferramentas de manutenção eletrônica e eletrotécnica



2028EL/A € 1.310,00 1 020281014

(2028/VV+5980EL/A)
2028ET/A € 1.320,00 1 020281018
(2028/VV+5980ET/A)

2029/VV

mala para ferramentas, em polipropileno espesso,
extremidades em alumínio

2 painéis para ferramentas

Fundo com divisórias amovíveis e ajustáveis

Fornecida com alça de ombro

Dois fechos com chave



2029/VV € 385,00 1 020290000

≡ 480x227x408 mm

2029E

malas de ferramentas com jogos de ferramentas para electrónica e manutenção electrotécnica



2029 BG MQ € 2.250,00 1 020291257

(2029/VV+5980MQ)
2029ET/B € 1.830,00 1 020291021

(2029/VV+5980ET/B)
2029EL/B € 1.850,00 1 020291017

(2029/VV+5980EL/B)

2029EM

mala com jogo de ferramentas para manutenção e reparação de veículos híbridos e elétricos



2029EM € 2.360,00 1 020290300

52MQ 7-8-9-10-11-12-13-14-15-16-17-19-22 mm

910MQ/B 6-7-10-12-13-17-19 mm

910MQ/TX TX25 - TX30 - TX40

910MQ/55

1048MQ 250 mm

1082MQ 160 mm

1128MQ 145 mm

1150MQ 180 mm

1162MQ 160 mm

1272MQ PH1 - PH2

1274MQ 2,5x75 - 3x100 - 4x100 - 5,5x125 - 6,5x150 mm

1760PT

1777MQ/U 190 mm

1996MQ/GM GM 10

7109A A1 - A2

7109D D2 - D3

2032/TV

carro para ferramentas, em plástico

2 painéis para ferramentas

Bolso para ferramenta

Fundo com componentes amovíveis



2032/TV € 520,00 1 020320110

≡ 450x200x400 mm



2032/TE

carro com sortidos de ferramentas para trabalhos de manutenção electrónica e electrotécnica



2032TET/A
(2032/TV+5980ET/A) € 1.570,00 1 020321328

2033L/VV

mala de ferramentas, em alumínio, vazia

- Elevada resistência a impactos
- Acabamento anti-riscos
- Punho ergonómico revestido a borracha
- Fecho duplo com combinação

- 2 painéis de ferramentas com elásticos
- Base interior com divisórias amovíveis



2033L/VV € 421,00 1 020330250
470x203x373 mm

2033L

mala de ferramentas em alumínio com sortido de ferramentas para manutenção eletrónica e eletrotécnica



2033LEL/A € 1.460,00 1 020331224
(2033L/VV+5980EL/A)
2033LEL/B € 1.880,00 1 020331225
(2033L/VV+5980EL/B)
2033LET/B € 1.860,00 1 020331237
(2033L/VV+5980ET/B)

2036/TV

carro para ferramentas, em polipropileno espesso, extremidade em alumínio

2 painéis para ferramentas
Pega telescópica
Rodízios de esferas



2036/TV € 610,00 1 020360000
480x267x408 mm

2036E

carro de ferramentas tipo trolley com jogos de ferramentas para electrónica e manutenção electrotécnica



2036TET/B € 2.050,00 1 020361223
(2036/TV+5980ET/B)
2036EL/B € 2.070,00 1 020361218
(2036/TV+5980EL/B)

2037/TV

Mala tipo trolley, em polipropileno, com 4 rodas, vazia

- Altamente resistente ao choque. Adequada para transporte em aviões.
- 2 painéis de ferramentas amovíveis.
- Porta-documentos incorporado.
- 4 rodízios amovíveis para manipulação horizontal do carro.
- 2 tabuleiros incluídos.
- 2 fechaduras aprovadas pela TSA com chaves.
- Pega revestida a borracha.



2037/TV € 755,00 1 020370000
482x295x478 mm

2038/TV

mala de ferramentas tipo trolley, em polipropileno espesso

- Elevada resistência a impactos
- Perfil vedante em alumínio
- 2 fechaduras aprovadas TSA com chaves
- 2 painéis de ferramentas amovíveis.
- Punho telescópico e rodas de grandes dimensões
- 2 punhos ergonómicos revestidos a borracha incluindo (1 punho lateral)
- Fundo espaçoso
- Bolsa porta-documentos
- 3 painéis de ferramentas interiores



2038/TV € 995,00 1 020380000
430x375x525 mm



2041UC

Jogo de 33 ferramentas em caixa



2041UC € 390,00 1 020410215

- 55 6x7 - 8x9 - 10x11 - 12x13 - 14x15 - 16x17 mm
- 96/SC9 1,5 - 2 - 2,5 - 3 - 4 - 5 - 6 - 8 - 10 mm
- 111E 200 mm
- 1048VN 250 mm
- 1128BMX 145 mm
- 1150 180 mm
- 1201E 2,5x50 - 3x75 - 4x100 - 5,5x100 - 6,5x150 mm
- 1202E PH0x60 - PH1x80 - PH2x100 mm
- 1370 300 g
- 1692 3m
- 1771 170 mm
- 1833S 70 Lumen / 140 mm
- 1639NS-N 25m
- 1696 200 mm

535x282x87 mm - 4,5 Kg

2051N

jogo de 55 ferramentas para manutenção naval com caixa em propileno anti-choque



2051N € 925,00 1 020510225

- 42 7 - 8 - 10 - 12 - 13 - 14 - 17 - 19 mm
- 55AS 3/8x7/16 - 1/2x9/16 - 5/8x11/16"
- 96/SC9 \varnothing 1,5+10 mm
- 111E 200 mm
- 920A \varnothing 10 - 12 - 13 - 14 - 17 - 19 mm
- 920AS \varnothing 7/16 - 1/2 - 9/16 - 11/16 - 7/8"
- 920/22 255 mm - \square 1/2 - \blacksquare 1/2
- 920/25 \square 1/2 - \blacksquare 1/2
- 920/42 \blacksquare 1/2
- 920/55 \blacksquare 1/2
- 956C \square 1/2 - 16 - 20,8 mm
- 1048BM 250 mm
- 1084BM 160 mm
- 1128BMX 145 mm
- 1150BM 180 mm
- 1166BM 160 mm
- 1201E \bullet 3x75 - 4x100 - 5,5x150 - 6,5x150 mm
- 1202E \oplus PH1x80 - PH2x100 mm
- 1390 \varnothing 35 mm
- 1490/2 \varnothing max 240 mm
- 1737 145 mm
- 1778X

BMN1436 3,6 x 140 mm

BMESB1925E 25 m

585x393x92 mm - 9 kg

2055HB

mala "Home Bag" com sortido de 24 ferramentas



2055HB € 236,00 1 020550215

- 55 6x7 - 8x9 - 10x11 - 12x13 mm
- 96N/SC9 1,5 - 2 - 2,5 - 3 - 4 - 5 - 6 - 8 - 10 mm
- 1128BMX 145 mm
- 1150 180 mm
- 1048VN 250 mm
- 1201E 3x75 - 4x100 - 5,5x100 mm
- 1202E PH0x60 - PH1x80 - PH2x100 mm
- 1370 300 g
- 1692 3m

373x275x70 mm - 3 Kg

2080/V6

estojo de ferramentas com 6 compartimentos amovíveis



2080/V6 mm € 44,00 1 020800060

2080/V6-U

estojo de ferramentas com 6 compartimentos amovíveis 2080/V6



2080/V6-U € 3,35 1 020800066

90x60x50 mm

2080/D10

conjunto de 10 divisórias ajustáveis, para estojo de ferramentas 2080/V6



2080/D10 € 9,00 1 020800070

2080/V12

estojo de ferramentas com 12 compartimentos amovíveis



2080/V12 mm € 69,50 1 020800000

2080/V12-...

estojo de ferramentas com 12 compartimentos amovíveis



2080/V12-S € 4,25 3 020800013

2080/V12-M € 6,40 2 020800015

2080/V12-L € 11,10 1 020800020

C3

mini saco de ferramentas, em tecido técnico

Características principais:

- 1 bolsa exterior frontal com fecho
- 2 bolsas laterais
- 1 bolsa traseira com fecho de velcro
- 1 painel de ferramentas interior amovível, com elásticos em ambos os lados
- porta USB para carregar dispositivos móveis
- Com alça para ombro



C3 € 74,50 1 021030000

≡ 230x110x320 mm - 890 g

C4 - 2104

estojo de ferramentas em tecido

Painel de ferramentas interno amovível

Bolsas internas e externas e suporte elástico para ferramenta

Base robusta impermeável com pés em borracha

Fornecido com alça de transporte



C4 € 126,00 1 021040000
 2104VU/0 € 575,00 1 021041122
 (C4+5915VU/0)

≡ 330x260x360 mm - 2,5 kg

C5S

mochila para ferramentas, em poliéster reforçado

- Pega dupla para sustentação firme e equilibrada
- Duas bolsas grandes exteriores frontais
- Duas bolsas interiores espaçosas, fitas adicionais com velcro para fecho
- Bolsa interna roll-up com 4 painéis
- Alças ajustáveis reforçadas
- Capacidade de carga máxima: 15 kg



C5S € 64,00 1 021050100

≡ 310x120x390 mm - 0,9 Kg

C5 - 2105

mochila para ferramentas, em tecido



C5 € 179,00 1 021050000
 2105VU/0 € 625,00 1 021051122
 (C5+5915VU/0)

≡ 400x200x500 mm - 2,5 Kg

C6T - 2106

mochila para ferramentas, em tecido, com rodas



C6T € 254,00 1 021060010
 2106T/VU0 € 700,00 1 021061123
 (C6T+5915VU/0)

≡ 360x200x480 mm - 4,5 kg

C7 - 2107

saco para ferramentas em tecido

2 painéis para ferramentas amovíveis

Bolsa interior em PC

2 bolsas exteriores

Base interior em plástico, com divisórias amovíveis



C7 € 265,00 1 021070000
 2107VU/2 € 735,00 1 021071112
 (C7+5915VU/2)

2107VU/3 € 1.270,00 1 021071114
 (C7+5915VU/3)

≡ 480x165x380 mm - 3,5 kg

C7AT

saco para ferramentas em tecido técnico

Características principais:

- em tecido técnico de elevada durabilidade
- base reforçada com pés de borracha
- pega superior dupla para manuseamento seguro e equilibrado
- bolso frontal grande para documentos com fecho de correr e compartimento adicional com fecho duplo velcro + clipe
- bolso lateral duplo com fecho em velcro
- compartimento interno espaçoso com bolso adicional para documentos
- Compartimento para PC e tablet com acolchoamento interior de proteção (tamanho do PC até L=370 mm, H=250 mm)
- abertura frontal com fecho de correr bidirecional para acesso rápido às ferramentas:
- 29 compartimentos e 13 faixas elásticas para ferramentas na parte frontal;
- 33 compartimentos para ferramentas na parte traseira.
- fornecido com alça de ombro acolchoada ajustável



C7AT

€ 142,00 1 021070010

≡ 470x200x340 mm

C8 - 2108

Mala de ferramentas tipo trolley em tecido high-tech

Punho telescópico

2 painéis de ferramentas interiores amovíveis
2 bolsos exteriores frontais

Pode ser equipada com caixa de ferramentas ref. C10S



€ 299,00 1 021080000
€ 840,00 1 021081022

≡ 470x280x380 mm - 4 kg

C8B

mala de ferramentas tipo em tecido técnico, para eletricitas

Estrutura rígida

Pega telescópica

4 rodízios

1 painel de ferramentas interior amovível

Bolso frontal com porta-cartões

Fundo duplo com tabuleiro

2 bolsos laterais exteriores

2 ganchos para regulação da alça

Pega dobrável para fácil acesso às ferramentas

Possibilidade de trancar cadeado não incluído)



C8B

€ 241,00 1 021080300

≡ 380x250x430 mm - 4,7 kg

C9 - 2109

saco para ferramentas em tecido

• Base rígida

• Bolsos interiores e exteriores para ferramentas

• Bolso exterior com fecho eclair para maior segurança

• Bolso para objectos pessoais com cinta de segurança

• Fundo duplo

• Cordão duplo para níveis

• Alça de ombro para fácil transporte



€ 145,00 1 021090000
€ 690,00 1 021091022
€ 1.150,00 1 021091024

≡ 550x280x320 mm - 2,6 kg

C9/RT

correia de ombro para artigos C9 e C10



C9/RT

€ 18,80 1 021090900

C9DA

saco para ferramentas com abertura grande

Características principais:

- em tecido técnico de elevada durabilidade
- base em plástico rígido, impermeável
- pega superior reforçada para manuseamento seguro
- bolso lateral duplo com fecho de velcro
- dois compartimentos laterais para ferramentas com aberturas grandes, para acesso rápido e perfeita visibilidade do conteúdo
- 22 compartimentos para ferramentas e compartimento adicional com fecho de correr na parte frontal
- 14 compartimentos para ferramentas e compartimento adicional com fecho de correr na parte traseira
- fornecido com alça de ombro acolchoada ajustável



C9DA

€ 115,00 1 021090005

≡ 420x220x310 mm

 **Beta**

C9MT

saco para ferramentas, vazio

- revestimento em PVC resistente, impermeável
- costuras reforçadas em todo o perímetro
- fecho com duas fivelas
- pega interior dupla para manuseamento seguro e equilibrado
- bolsa para documentos com fecho de correr



C9MT € 102,00 1 021090200

450x180x200 mm

2109MT ID/1

mala com jogo de 24 ferramentas para canalizadores



2109MT ID/1 € 710,00 1 021091026
(C9MT+5980ID/1)

- 111E 250 mm
- 332 Ø 3+28 mm
- 334 Ø 3+30 mm
- 342 Ø 0+42 mm
- 345SB2 140 mm
- 376 320-410 mm
- 1048N 175-250 mm
- 1128BMX
- 1150GBM 180 mm
- 1201E 3x75-4x100-5,5x150-8x150 mm
- 1202E PH1x80-PH2x100
- 1370 500 g
- 1690F 2 m
- 1692/5 5 m
- 1696 200 mm
- 1719BMA...M 200 mm
- 1719BM/RL 200 mm
- 1725

Beta

C9PT



C9PT 321

C10 - 2110

saco para ferramentas em tecido

Estrutura rígida
Fundo duplo. Possibilidade de remoção para maior capacidade do saco.
Pega inclinável para fácil acesso ao conteúdo
Cintas elásticas para ferramentas e bolsos interiores e exteriores
Pala de cobertura
Tabuleiro para ferramentas incluído no fundo duplo



C10 € 182,00 1 021100000
2110VU/1 € 725,00 1 021101031
(C10+5915VU/1)
2110VU/3 € 1.190,00 1 021101034
(C10+5915VU/3)
2110VU/AS € 1.290,00 1 021101036
(C10+5915VU/AS)

520x220x250 mm - 3,3 kg

C10S - 2110S

saco para ferramentas em tecido

Estrutura rígida
Fundo duplo. Possibilidade de remoção para maior capacidade do saco.
Pega inclinável para fácil acesso ao conteúdo
Cintas elásticas para ferramentas e bolsos interiores e exteriores
Pala de cobertura
Tabuleiro para ferramentas incluído no fundo duplo



C10S € 143,00 1 021100001
2110SVU/1 € 685,00 1 021101041
(C10S+5915VU/1)
2110SVU/3 € 1.150,00 1 021101044
(C10S+5915VU/3)

420x220x250 mm - 2,3 kg

C11 - 2111

caixa de ferramentas, em tecido



C11 € 106,00 1 021110000
2111VU/1 € 650,00 1 021111031
(C11+5915VU/1)
2111VU/3 € 1.120,00 1 021111034
(C11+5915VU/3)

410x230x250 mm - 2 kg

Beta



C12 - 2112

saco para ferramentas em tecido

Painel de ferramentas interior amovível
Elásticos para fixação das ferramentas e bolsas interiores e exteriores espaçosas
Abertura frontal para acesso mais fácil ao conteúdo
Base impermeável rígida com pés de borracha
Pode ser utilizado com o trolley C8



	€		
C12	230,00	1	021120000
2112ET/A (C12+5980ET/A)	1.280,00	1	021121028
2112ET/B (C12+5980ET/B)	1.670,00	1	021121029
2112VU/5 (C12+5915VU/5)	1.510,00	1	021121056

500x270x350 mm - 5 kg

C13

mala de ferramentas com rodízios, em polipropileno resistente

- Adequada a utilização no exterior
- Resistente ao impacto e a agentes químicos
- Pode ser fechada a cadeado (cadeado não incluído)
- Fecho duplo
- Duas rodas para movimentação horizontal
- Com tabuleiro de ferramentas interior amovível e bloqueável em duas posições
- Placa de identificação



	€		
C13	380,00	1	021130000

806x350x467 mm - 7,2 kg

C14

mala de ferramentas tipo trolley (fornecida vazia), em polipropileno, com 4 gavetas

- Estrutura em polipropileno de injeção para maior resistência ao impacto
- A tampa de proteção frontal acomoda 4 gavetas amovíveis (470x255):
1 gaveta 30 mm altura
2 gavetas 60 mm altura
1 gaveta 90 mm altura
- Fechadura centralizada frontal que permite trancar as tampas superior e frontal simultaneamente
- 2 pegas laterais
- 4 rodas traseiras resistentes
- Tabuleiro superior removível
- Painel de ferramentas embutido na tampa
- 3 tabuleiros
- Placa de identificação
- Fechadura TSA



	€		
C14	970,00	1	021140000
2114VU/M (C14+5914VU/M)	2.170,00	1	021141011

585x390x457 mm - 10 kg

CP15 - 2115

caixa de ferramentas, em plástico, com tabuleiros de ferramentas amovíveis

- 1 tabuleiro integrado na tampa
- 2 tabuleiros amovíveis com divisórias ajustáveis
- 1 tabuleiro interior com divisórias ajustáveis



	€		
CP15	56,50	1	021150201
2115PVU/1 (CP15+5915VU/1)	600,00	1	021151232
2115PVU/2 (CP15+5915VU/2)	530,00	1	021151234

445x240x250 mm - 2 kg

CP15L - 2115

caixa de ferramentas, série longa, em plástico, com tabuleiros de ferramentas amovíveis

- 3 tabuleiros integrados na tampa com divisórias ajustáveis
- 1 tabuleiro interior com divisórias ajustáveis



	€		
CP15L	76,50	1	021150202
2115PL-VU/1 (CP15L+5915VU/1)	620,00	1	021151242
2115PL-VU/3 (CP15L+5915VU/3)	1.090,00	1	021151245

558x277x270 mm - 2,5 kg

2115PI/BIKE-HOME

Sortido de 28 ferramentas

Reparação de bicicletas



	€		
2115PI/BIKE-HOME	302,00	1	021150098

96BP/SC9
3935
3969K3
42 8-9-10-13-14 mm
42SLIM 15 mm
1082G 160 mm
1150G 180 mm
1201E 3x75 - 5,5x150 mm
1202E PH0x60 - PH2x100 mm
3991

BMESB1925NE 25 m
BMN1436 3,6 x 140 mm

558x277x270 mm - 4,3 kg





2115P L-MQ32

jogo 32 ferramentas isoladas para veículos híbridos, em estojo de plástico com tabuleiro em esponja suave



2115PL-MQ32 € 1.300,00 1 021150332

920MQ/55A

89MQ 10-12 mm

850MQ 1/4"

860TX/A10 T7-T8-T9-T10-T15-T20-T25-T27-T30-T40

920MQ/A 8-10-12-13-14-17-19 mm

920MQ/21 125mm

920MQ/22 250mm

1048MQ250 250mm

1150MQ 180mm

1164MQ160 160mm

1272MQ 4.5X80-6X100mm

1274MQ 3X100-4X100-5.5X125

1995MQ/G2 G2

CP15L

C16 - 2116

caixa de ferramentas, em plástico, com compartimentos interiores, vazia



C16 € 125,00 1 021160000
 2116VU/1 € 670,00 1 021161102 (C16+5915VU/1)
 2116VU/3 € 1.140,00 1 021161105 (C16+5915VU/3)

500x260x260 mm - 2,5 kg

CP17 - CP17L - 2117

caixa de ferramentas, feita de aço inoxidável e plástico, bandeja de carga removível



CP17
500x200x220 mm



CP17L
575x245x265 mm

CP17 € 105,00 1 021170500
 2117P-VU/1 € 650,00 1 021171042 (CP17+5915VU/1)
 2117P-VU/3 € 1.120,00 1 021171045 (CP17+5915VU/3)
 CP17L € 151,00 1 021170502
 2117L-VU/1 € 695,00 1 021171142 (CP17L+5915VU/1)
 2117PL-VU/3 € 1.160,00 1 021171145 (CP17L+5915VU/3)

C18 - 2118

caixa para ferramenta em chapa metálica



C18 € 49,50 1 021180001
 2118VU/1 € 595,00 1 021181032 (C18+5915VU/1)
 450x200x100 mm - 3 kg

C19 - 2119 - C19L - 2119L

caixa extensível com três divisões em chapa metálica



C19
450x200x160 mm



C19L
550x200x160 mm

C19 € 65,50 1 021190001
 2119VU/3 € 1.080,00 1 021191025 (C19+5915VU/3)
 C19L € 84,00 1 021190002
 2119L-VU/3 € 1.090,00 1 021191125 (C19L+5915VU/3)

G20 - G20L - 2120

caixa extensível com cinco divisões em chapa metálica



G20
450x200x210 mm



G20L
550x200x210 mm

G20 € 92,50 1 021200001
 2120VU/2 € 565,00 1 021201061 (G20+5915VU/2)
 2120VU/3 € 1.100,00 1 021201063 (G20+5915VU/3)
 2120VU/4 € 1.400,00 1 021201064 (G20+5915VU/4)
 2120VU/AS € 1.200,00 1 021201068 (G20+5915VU/AS)
 G20L € 101,00 1 021200002
 2120L-VU/2 € 575,00 1 021201161 (G20L+5915VU/2)
 2120L-VU/3 € 1.110,00 1 021201163 (G20L+5915VU/3)
 2120L-VU/4 € 1.410,00 1 021201164 (G20L+5915VU/4)
 2120L-VU/AS € 1.210,00 1 021201168 (G20L+5915VU/AS)



C20TSS

Caixa de ferramentas extensível com 5 divisões, em axo inox AISI 304



C20TSS € 321,00 1 021203001

≡: 450x200x210 mm - 4kg

C22B

caixa de ferramentas metálica



C22B O
≡ 720x320x310 mm



C22BM O
≡ 850x360x350 mm



C22BL O
≡ 1010x410x400 mm

C22B-O € 262,00 1 022000150
C22BM-O 301,00 1 022000160
C22BL-O 402,00 1 022000170

C22B O: 13 kg
C22BM O: 20 kg
C22BL O: 26 kg

C22W

caixa para ferramenta vazia, em chapa metálica, forrada, para uma maior protecção da ferramenta



C22W-O
≡ 690x300x360 mm



C22WL-O
≡ 990x300x360 mm

C22W-O € 292,00 1 022000269
C22WL-O 379,00 1 022000299

C22W O: 15 kg
C22WL O: 28 kg

C22P

baú para ferramentas para a construção civil, em chapa metálica
pegas retrácteis integradas,
sapatas elevadas para mobilização com porta-paletes,
fechadura dupla anti-roubo (não incluída)



C22PM O
≡ 915x540x430 mm



C22PL O
≡ 1220x720x615 mm

C22PM-O € 780,00 1 022000240
C22PL-O 1.210,00 1 022000245

C22PM O: 39 kg
C22PL O: 67 kg





C99

Combo é o Sistema modular da Beta constituído por **3 tipos distintos de malas de ferramentas**

para manter o seu material de trabalho totalmente seguro e organizado.

As malas são facilmente encaixáveis entre si, através de um prático mecanismo de fecho lateral.

O sistema Beta Combo C99 está em conformidade com a norma L-BOXX by Sortimo®.

C99

BETA COMBO sistema modular

As malas de ferramentas são facilmente encaixáveis entre si, através de um prático mecanismo de fecho lateral.

Inclui:

- Trolley dobrável ultracompacto com pega telescópica C99P (485x520x1095 mm)
- Caixa de ferramentas em ABS, C99V1 (445x358x152 mm)
- Caixa de ferramentas em ABS, C99V2 (445x358x254 mm)
- Caixa de ferramentas em ABS, com 2 tabuleiros portáteis C99V3/2C (445x358x322 mm)



C99 € 770,00 1 099000010

C99V0

mala de ferramentas COMBO em ABS, com tampa transparente

As malas de ferramentas são facilmente encaixáveis entre si, através de um prático mecanismo de fecho lateral.

Caraterísticas principais:

- Tampa transparente em policarbonato resistente para identificação rápida do conteúdo
- Dimensões externas: 445x358x118 mm
- Capacidade máxima de carga interna: 25 kg
- Pode levar cadeado
- Peso: 2.5 kg

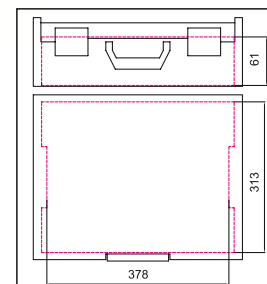

C99V0 € 123,00 1 099000202

C99V0-P12

mala de ferramentas COMBO em ABS, com tampa transparente

As malas de ferramentas são facilmente encaixáveis entre si, através de um prático mecanismo de fecho lateral.

Características principais:

- Tampa transparente em policarbonato resistente para identificação rápida do conteúdo
- Particularmente adequada para transportar pequenos utensílios, incluindo parafusos, porcas, arruelas, rebites e buchas
- Fornecida com kit de 18 compartimentos:
 - 2 compartimentos vermelhos, 52x52 mm
 - 3 compartimentos amarelos, 104x52 mm
 - 2 compartimentos azuis, 104x104 mm
 - 1 compartimentos verdes, 104x156 mm
 - 2 compartimentos laranja, 208x52 mm
 - 2 compartimentos cinza, 312x71 mm, e 6 compartimentos ajustáveis
- Dimensões externas: 445x358x118 mm
- Capacidade máxima de carga interna: 25 kg
- Pode levar cadeado
- Peso: 3.2 kg

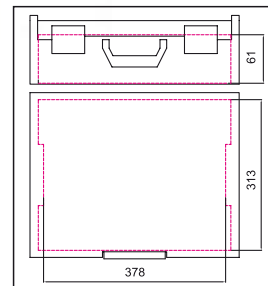

C99V0-P12 € 174,00 1 099000200

C99P12-V0

kit de 18 tabuleiros para caixas de ferramentas C99V0

Conteúdo do kit:

- 2 tabuleiros vermelhos, 52x52 mm
- 3 tabuleiros amarelos, 104x52 mm
- 2 tabuleiros azuis, 104x104 mm
- 1 tabuleiro verde, 104x156 mm
- 2 tabuleiros laranja, 208x52 mm
- 2 tabuleiros cinza, 312x71 mm, e 6 divisórias



C99P12-V0 € 54,00 1 099000499

C99V1

Malas de ferramentas COMBO em ABS

As malas de ferramentas são facilmente encaixáveis entre si, através de um prático mecanismo de fecho lateral.

Principais características:

- Dimensões externas: 445x358x152 mm
- Capacidade máxima de carga interna: 25 kg
- Pode levar cadeado
- Peso: 2.2 kg

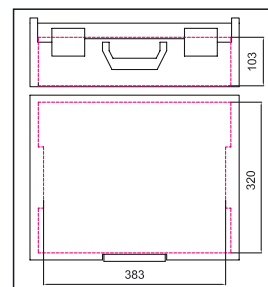

C99V1 € 125,00 1 099000250

C99V2

Mala de ferramentas COMBO em ABS

As malas de ferramentas são facilmente encaixáveis entre si, através de um prático mecanismo de fecho lateral.

Principais características:

- Dimensões externas: 445x358x254 mm
- Capacidade máxima de carga interna: 25 kg
- Peso: 2.8 kg

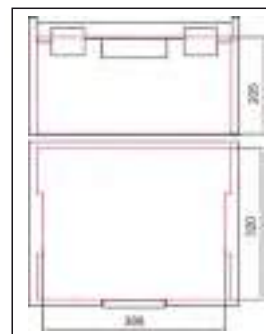

C99V2

€ 138,00 1 099000350

C99V3/2C

Mala de ferramentas COMBO em ABS, com 2 tabuleiros portáteis

As malas de ferramentas são facilmente encaixáveis entre si, através de um prático mecanismo de fecho lateral.

Principais características:

- Dimensões externas: 445x358x322 mm
- Capacidade máxima de carga interna: 25 kg
- Fornecido com 2 tabuleiros C99C-V3 vazios
- Peso: 5.6 kg

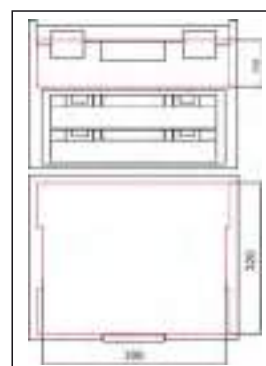

C99V3/2C

€ 265,00 1 099000450

C99C-V3

Caixa de ferramentas

Tampa transparente para rápida identificação do conteúdo

Pega embutida

Dimensões exteriores: 367x316x72 mm

Peso: 0.9 kg

Pode ser equipada com:

- Tabuleiro rígido de 7 compartimentos C99T-V3
- kit of 17 tabuleiros referência C99P-V3

C99C-V3 € 44,50 1 099000496

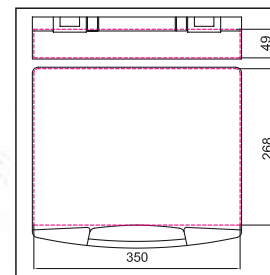

C99P

Carro de ferramentas tipo trolley rebatível

Principais características:

- Trolley de ferramentas rebatível ultracompacto
- Pega telescópica
- Dimensões aberto: 485x520x1095 mm
- Dimensões fechado: 485x80x810 mm
- Dimensões da base dobrável: 480x350 mm
- Duas rodas à prova de perfurações, Ø 175 mm
- Fornecido com alça
- Capacidade máxima: 100 kg
- Peso: 5.8 kg

C99P € 239,00 1 099000101



C99PC

Insert de proteção para malas de ferramentas C99V1 e C99V3/2C

Utilizado em combinação com os inserts soft, para proteger e conter o conteúdo dos compartimentos, evitando que se misturem durante o transporte.

C99PC 400x320x20 mm € 21,10 1 099000491



C99PP

painel para malas de ferramentas COMBO

C99PP € 57,00 1 099000489





RSC22

bloco de ferramentas portátil com 3 gavetas

Características principais:

- 3 gavetas (588x277 mm) com guias de rolamentos de esfera:
- 1 gaveta, 50 mm altura
- 2 gavetas, 70 mm altura.
- Fechadura centralizada de segurança frontal.
- Punhos laterais retráteis para fácil movimentação.

19 kg



RSC22-O



RSC22-A



RSC22-R



h	max
50 mm	25 kg
70 mm	25 kg

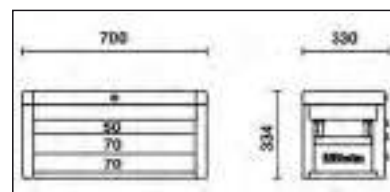
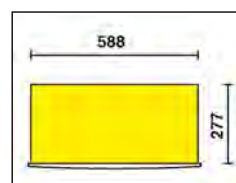

		€	1	022003001
RSC22-O	RAL 2011	540,00	1	022003001
RSC22-R	RAL 3000	540,00	1	022003003
RSC22-A	RAL 7016	540,00	1	022003007

RSC23

bloco de ferramentas portátil
com 5 gavetas

Características principais:

- 5 gavetas (588x277 mm)
- com guias de rolamentos de esfera:
- 2 gavetas, 50 mm altura
- 3 gavetas, 70 mm altura.
- Fechadura centralizada de segurança frontal.
- Punhos laterais retráteis para fácil movimentação.

📦 26 kg



RSC23-A



RSC23-R



RSC23-O



h	max
50 mm	25 kg
70 mm	25 kg

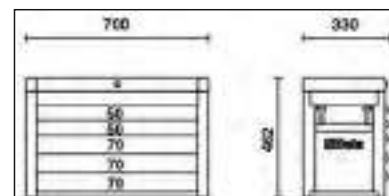
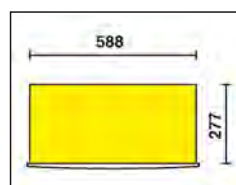

		€	📦	🏠
RSC23-O	RAL 2011	685,00	1	023003001
RSC23-R	RAL 3000	685,00	1	023003003
RSC23-A	RAL 7016	685,00	1	023003007

CD23S

trolley Caddy

Características principais:

- Plano de trabalho em ABS compatível com os modelos C22S, C23S, C23SC, C23ST.
- A pega amovível pode ser guardada debaixo do chassis.
- 4 rodízios de Ø 125 mm:
- 2 fixos e 2 giratórios (um com travão).
- Carga máxima: 250 kg.

📦 14 kg



		€	📦	🏠
CD23S		314,00	1	023000610

RSC23C

bloco de ferramentas portátil
com 8 gavetas

Características principais:

- 8 gavetas (588x277 mm) com guias de rolamentos de esfera:
- 4 gavetas, 50 mm altura
- 3 gavetas, 70 mm altura
- 1 gaveta, 100 mm altura.
- Fechadura centralizada de segurança frontal.
- Punhos laterais retráteis para fácil movimentação.

📦 28 kg



RSC23C-A



RSC23C-R



RSC23C-O



h	max
50 mm	25 kg
70 mm	25 kg

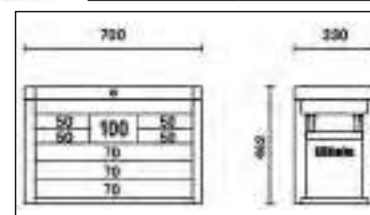
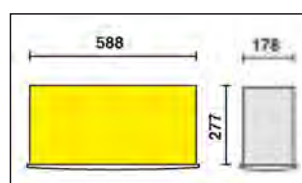

		€	📦	🏠
RSC23C-O	RAL 2011	775,00	1	023003011
RSC23C-R	RAL 3000	775,00	1	023003013
RSC23C-A	RAL 7016	775,00	1	023003017

RSC23T

bloco de ferramentas portátil
com 5 gavetas

Características principais:

- 5 gavetas (588x367 mm) com guias de rolamentos de esfera:
- 5 gavetas, 70 mm altura.
- Fechadura centralizada de segurança frontal.
- Pode ser equipado com 4 rodízios e 1 punho (2300ST/KIT)

📦 36 kg



RSC23T-A



RSC23T-B



RSC23T-G



RSC23T-N



RSC23T-R



RSC23T-O



RSC23T-FO

h	max
70 mm	25 kg

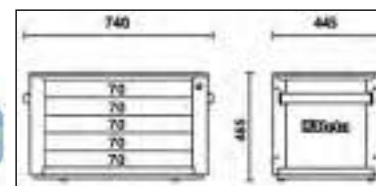

		€	📦	📄
RSC23T-FO	RAL 2011	865,00	1	023003020
RSC23T-O	RAL 2011	865,00	1	023003021
RSC23T-G	RAL 9006	865,00	1	023003022
RSC23T-R	RAL 3000	865,00	1	023003023
RSC23T-B	RAL 5015	865,00	1	023003026
RSC23T-A	RAL 7016	865,00	1	023003027
RSC23T-N	RAL 9005	865,00	1	023003029

2300ST/KIT

kit de 4 rodízios e 1 punho para C23ST

- Quatro rodízios, Ø 125 mm:
- 2 fixos e 2 giratórios (um com travão).
- Punho telescópico

📦 6,5 kg

	€	📦	📄
2300ST/KIT	232,00	1	023000950



CARRO DE FERRAMENTAS RSC24

Beta
RSC24



NOVA SUPERFÍCIE DE TRABALHO

**MAIS FIRME E ROBUSTA
MAIS CONVENIENTE
E FUNCIONAL
MAIS MODERNA**



- Gavetas com guias de rolamentos de esferas
- Fundos das gavetas protegidos por tapetes em borracha
- Cada gaveta pode acomodar até 4 tabuleiros em esponja EVA ou ABS
- Nova superfície de trabalho em ABS reforçado, concebida para suportar os baús de ferramentas RSC22, RSC23, RSC23C e RSC23T
- Superfície de trabalho multiusos com arestas anti-queda e oito furos para chaves de fendas
- Fechadura frontal centralizada
- Quatro rodízios Ø 125 mm: 2 fixos e 2 giratórios (um com travão)
- Capacidade de carga estática: 800 kg

Modelos disponíveis:

- RSC24/5 (5 gavetas)
- RSC24/6 (6 gavetas)
- RSC24/7 (7 gavetas)
- RSC24/8 (8 gavetas)

Acessórios disponíveis:



Cores disponíveis:

RSC24-		
FO	RAL 2011	RAL 2011
O	RAL 7016	RAL 2011
G	RAL 7016	RAL 9006
R	RAL 7016	RAL 3000
B	RAL 7016	RAL 5015
A	RAL 7016	RAL 7016
N	RAL 9005	RAL 9005

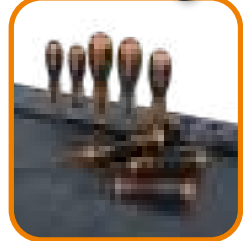
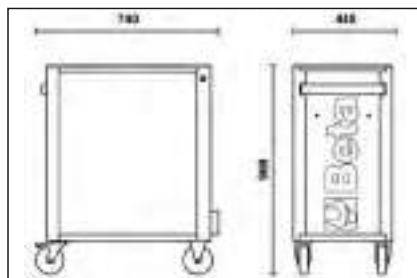

RSC24/7

carro de ferramentas com 7 gavetas

Características principais:

- 7 gavetas completamente amovíveis (588x367 mm), com guias de esferas:
- 5 gavetas, 70 mm altura
- 1 gaveta, 140 mm altura
- 1 gaveta, 210 mm altura

63 kg



RSC24/7-O

Beta
RSC24



h	max
70 mm	25 kg
140 mm	30 kg
210 mm	30 kg

Modelo	€	Q	Art.º
RSC24/7-FO	1.200,00	1	024004070
RSC24/7-O	1.200,00	1	024004071
RSC24/7-G	1.200,00	1	024004072
RSC24/7-R	1.200,00	1	024004073
RSC24/7-B	1.200,00	1	024004076
RSC24/7-A	1.200,00	1	024004077
RSC24/7-N	1.200,00	1	024004079

RSC24/5

carro de ferramentas com 5 gavetas

Características principais:

- 5 gavetas completamente amovíveis (588x367 mm), com guias de esferas:
- 2 gavetas, 70 mm altura
- 2 gavetas, 140 mm altura
- 1 gaveta, 280 mm altura

60 kg

	€	🔧	📄
RSC24/5-FO	1.040,00	1	024004050
RSC24/5-O	1.040,00	1	024004051
RSC24/5-G	1.040,00	1	024004052
RSC24/5-R	1.040,00	1	024004053
RSC24/5-B	1.040,00	1	024004056
RSC24/5-A	1.040,00	1	024004057
RSC24/5-N	1.040,00	1	024004059



RSC24/5-O

Beta RSC24



h	max
70 mm	25 kg
140 mm	30 kg
280 mm	35 kg

RSC24/6

carro de ferramentas com 6 gavetas

Características principais:

- 6 gavetas completamente amovíveis (588x367 mm), com guias de esferas:
- 4 gavetas, 70 mm altura
- 1 gavetas, 140 mm altura
- 1 gavetas, 280 mm altura

62 kg

	€	🔧	📄
RSC24/6-FO	1.120,00	1	024004060
RSC24/6-O	1.120,00	1	024004061
RSC24/6-G	1.120,00	1	024004062
RSC24/6-R	1.120,00	1	024004063
RSC24/6-B	1.120,00	1	024004066
RSC24/6-A	1.120,00	1	024004067
RSC24/6-N	1.120,00	1	024004069



RSC24/6-O

Beta RSC24



h	max
70 mm	25 kg
140 mm	30 kg
280 mm	35 kg

RSC24/8

carro de ferramentas com 8 gavetas

Características principais:

- 8 gavetas completamente amovíveis (588x367 mm), com guias de esferas:
- 6 gavetas, 70 mm altura
- 2 gavetas, 140 mm altura

66 kg

	€	🔧	📄
RSC24/8-FO	1.300,00	1	024004080
RSC24/8-O	1.300,00	1	024004081
RSC24/8-G	1.300,00	1	024004082
RSC24/8-R	1.300,00	1	024004083
RSC24/8-B	1.300,00	1	024004086
RSC24/8-A	1.300,00	1	024004087
RSC24/8-N	1.300,00	1	024004089



RSC24/8-O

Beta RSC24



h	max
70 mm	25 kg
140 mm	30 kg

RSC24A/6

carro com 6 gavetas,
com sistema anti-inclinação

Características principais:

- 6 gavetas totalmente amovíveis (588x367 mm), com guias de rolamentos de esfera:
- 4 gavetas, 70 mm altura
- 1 gaveta, 140 mm altura
- 1 gaveta, 280 mm altura

62 kg

	€	📦	📄
RSC24A/6-O	1.240,00	1	024004161
RSC24A/6-R	1.240,00	1	024004163
RSC24A/6-A	1.240,00	1	024004167



Beta RSC24



RSC24A/6-A



RSC24A/6-R



h	max
70 mm	25 kg
140 mm	30 kg
280 mm	35 kg

RSC24A/7

carro com 7 gavetas,
com sistema anti-inclinação

Características principais:

- 7 gavetas totalmente amovíveis (588x367 mm), com guias de rolamentos de esfera:
- 5 gavetas, 70 mm altura
- 1 gaveta, 140 mm altura
- 1 gaveta, 210 mm altura.

63 kg

	€	📦	📄
RSC24A/7-O	1.330,00	1	024004171
RSC24A/7-R	1.330,00	1	024004173
RSC24A/7-A	1.330,00	1	024004177



Beta RSC24



RSC24A/7-A



RSC24A/7-R



h	max
70 mm	25 kg
140 mm	30 kg
210 mm	30 kg

RSC24A/8

carro com 8 gavetas,
com sistema anti-inclinação

Características principais:

- 8 gavetas totalmente amovíveis (588x367 mm), com guias de rolamentos de esfera:
- 6 gavetas, 70 mm altura
- 2 gavetas, 140 mm altura

66 kg

	€	📦	📄
RSC24A/8-O	1.440,00	1	024004181
RSC24A/8-R	1.440,00	1	024004183
RSC24A/8-A	1.440,00	1	024004187



Beta RSC24



RSC24A/8-A



RSC24A/8-R



h	max
70 mm	25 kg
140 mm	30 kg



VERSÃO LONGA:
cada gaveta pode acomodar até 6 tabuleiros em espuma EVA ou em ABS

SISTEMA ANTI-QUEDA: IMPEDE QUE VÁRIAS GAVETAS SEJAM ABERTAS EM SIMULTÂNEO



- Gavetas com guias de rolamentos de esferas
- Superfície multiusos com sistema anti-inclinação, oito orifícios para chaves de fendas e 6 compartimentos para ferramentas.
- Frente robusta em nylon, com porta-etiquetas integrado
- Quatro rodízios Ø 125 mm: 2 fixos e 2 giratórios (um com travão)
- Capacidade de carga estática: 1000 kg
- Fundos das gavetas protegidos com tapetes em espuma de borracha
- Porta-garrafas lateral integrado
- Fechadura frontal centralizada

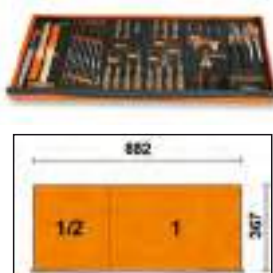
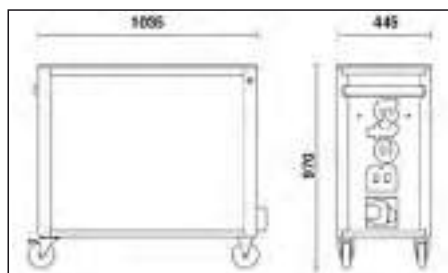

Cores disponíveis:

O	RAL 7016	RAL 2011
R	RAL 7016	RAL 3000
A	RAL 7016	RAL 7016

Acessórios disponíveis:



RSC24AXL/7

carro com 7 gavetas, com sistema anti-inclinação, modelo longo

Características principais:

- 7 gavetas totalmente amovíveis (882x367 mm), com guias de rolamentos de esfera:
- 5 gavetas, 70 mm altura
- 1 gaveta, 140 mm altura
- 1 gaveta, 210 mm altura



h	max
70 mm	30 kg
140 mm	35 kg
210 mm	35 kg



84 kg

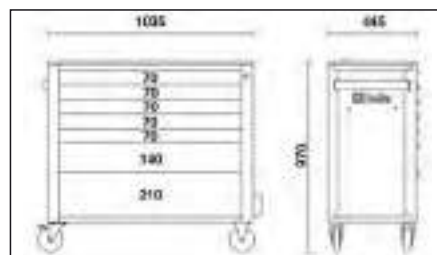
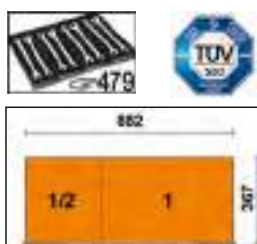

RSC24AXL/7-O	1.690,00	1	024004271
RSC24AXL/7-R	1.690,00	1	024004273
RSC24AXL/7-A	1.690,00	1	024004277

RSC24AXL/8

carro com 8 gavetas,
com sistema anti-inclinação,
modelo longo

Características principais:

- 8 gavetas totalmente amovíveis (882x367 mm), com guias de rolamentos de esfera:
- 6 gavetas, 70 mm altura.
- 2 gavetas, 140 mm altura.

88 kg

	€	↓	📄
RSC24AXL/8-O	1.810,00	1	024004281
RSC24AXL/8-R	1.810,00	1	024004283
RSC24AXL/8-A	1.810,00	1	024004287



h	↓ max
70 mm	30 kg
140 mm	35 kg



RSC24AXL/9

carro com 9 gavetas,
com sistema anti-inclinação,
modelo longo

Características principais:

- 9 gavetas totalmente amovíveis (882x367 mm), com guias de rolamentos de esfera:
- 8 gavetas, 70 mm altura
- 1 gaveta, 140 mm altura.

90 kg

	€	↓	📄
RSC24AXL/9-O	1.920,00	1	024004291
RSC24AXL/9-R	1.920,00	1	024004293
RSC24AXL/9-A	1.920,00	1	024004297



h	↓ max
70 mm	30 kg
140 mm	35 kg

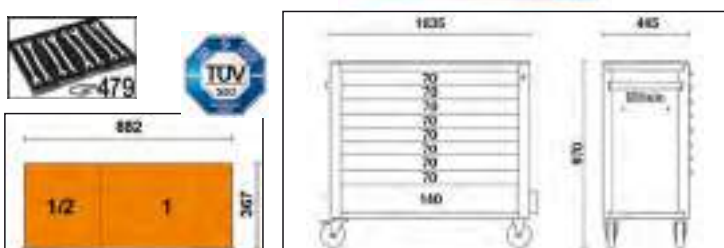

RSC24AXLP/7

carro com 7 gavetas, com plano de trabalho em madeira e sistema anti-inclinação, modelo longo

CARACTERÍSTICAS:

- 7 gavetas totalmente amovíveis (882x367 mm), com guias de rolamentos de esferas:
- 5 gavetas, 70 mm altura
- 1 gavetas, 140 mm altura
- 1 gavetas, 210 mm altura
- Plano de trabalho em madeira laminada com orifícios para torno 1599F/100 ou 1599GI/100 (a encomendar em separado)
- Parte frontal em nylon robusto, com porta-etiquetas
- Fundo das gavetas protegida com tapete de borracha
- 4 rodízios, Ø 125 mm: 2 fixos e 2 direcionáveis (um com travão)
- Fechadura frontal centralizada
- Capacidade de carga estática: 1.100 kg
- Porta-garrafas lateral integrado (possibilidade de montagem em ambos os lados)
- Porta-rolos de papel integrado
- Cada gaveta pode acomodar até 6 bandejas EVA ou ABS

1105 kg

1100 kg

Beta RSC24



RSC24AXLP/7-O



RSC24AXLP/7-A



RSC24AXLP/7-R

h	max
70 mm	30 kg
140 mm	35 kg
210 mm	35 kg

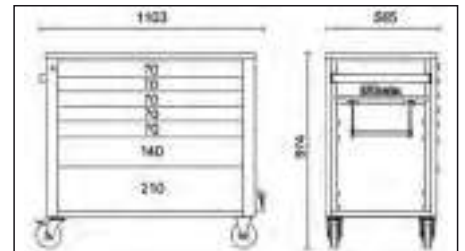
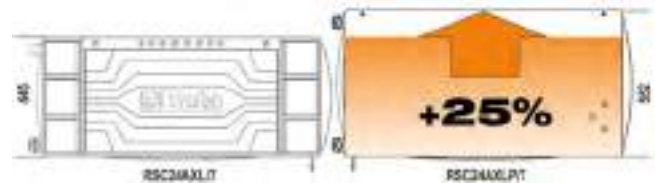

	€		
RSC24AXLP/7-O	1.940,00	1	024004571
RSC24AXLP/7-R	1.940,00	1	024004573
RSC24AXLP/7-A	1.940,00	1	024004577

2400 RSC24AXLP/CPR

caixote de lixo para carro RSC24AXLP/7

5 kg



	€		
2400 RSC24AXLP/CPR	75,00	1	024004993

2400 RSC24AXLP/PF

painel de ferramentas perfurado com suportes, para carro RSC24AXLP/7

4,5 kg



	€		
2400 RSC24AXLP/PF	137,00	1	024004992

2400 RSC24AXLP/VL

tabuleiro lateral de ferramentas para carro RSC24AXLP/7

4 kg

2400 RSC24AXLP/VL

€ 57,50 1 024004995



2400 RSC24/PC

porta-rolos de papel para carro RSC24, RSC24A, RSC24AXL, RSC51

0,3 kg

2400 RSC24/PC-A
2400 RSC24/PC-N

€ 28,50 1 024004903
€ 28,50 1 024004904



RAL7016 2400 RSC24/PC-A
RAL9005 2400 RSC24/PC-N



2400 RSC24/PD

porta-documentos para carro RSC24, RSC24A, RSC24AXL

1,2 kg

2400 RSC24/PD-A
2400 RSC24/PD-N

€ 49,50 1 024004907
€ 49,50 1 024004908



RAL7016 2400 RSC24/PD-A
RAL9005 2400 RSC24/PD-N



2400 RSC24/PF

painel de ferramentas perfurado com suportes, para carro RSC24, RSC24A, RSC51

2,3 kg

2400 RSC24/PF

€ 89,50 1 024004902

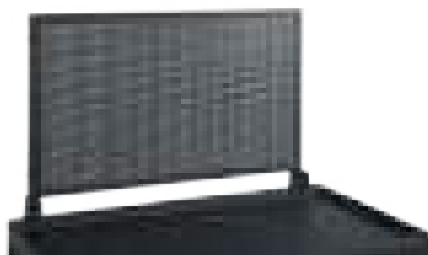

2400 RSC24/PF-

porta-garrafas para carro RSC24, RSC24A

0,5 kg

2400 RSC24/PF-A
2400 RSC24/PF-N

€ 30,00 1 024004905
€ 30,00 1 024004906



RAL7016 2400S RSC24/PF-A
RAL9005 2400S RSC24/PF-N



2400 RSC24/PL

tampo de trabalho em madeira para carro RSC24, RSC24A, RSC24AXL, RSC51

4,3 kg

2400 RSC24/PL

€ 112,00 1 024004901



2400 RSC24/SPC

suporte para computador para carro RSC24, RSC24A, RSC24AXLP/7, RSC51

- Com gaveta amovível
- Não pode ser utilizado com o modelo RSC24AXL

📦 3,1 kg

2400 RSC24/SPC	€	1	024004909
----------------	---	---	-----------



2400 RSC24/MP

prateleira dobrável para artigos RSC24, RSC24A, RSC24AXLP/7, RSC51

- Para utilização como superfície de trabalho adicional
- Dimensões superfície de trabalho: 390x440 mm, com tapete de borracha à prova de gasóleo e gasolina
- Capacidade de carga: 20 kg

📦 3,4 kg

2400 RSC24/MP	€	1	024004900
---------------	---	---	-----------



2499PF

prateleira porta-garrafas

- Podem ser instalados nos carros C38, C38A

📦 2,5 kg

2499PF-O	€	1	024990210
2499PF-G	€	1	024990219
2499PF-R	€	1	024990230

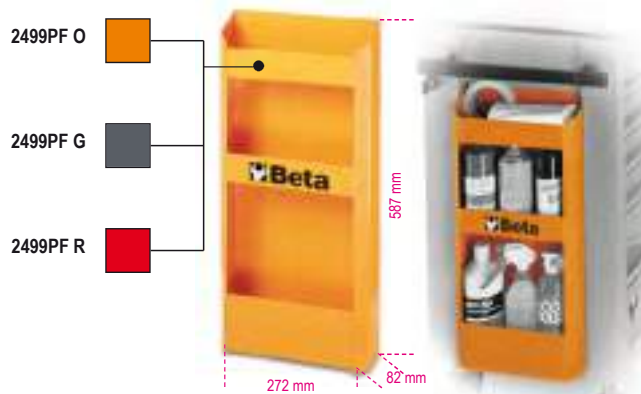

2499PF/M

suporte magnético universal para garrafas

📦 2,2 kg

2499PF/M	€	1	024990050
----------	---	---	-----------



2499PC

porta-rolos de papel

- Compatível com os carros C25 e C38.

📦 2,2 kg

2499PC	€	1	024990090
--------	---	---	-----------



RSC24L/7

carro com 7 gavetas
e prateleiras laterais

Características principais:

- 7 gavetas (588x367 mm)
com guias de rolamentos de esfera:
- 5 gavetas, 70 mm altura
- 1 gaveta, 140 mm altura
- 1 gaveta, 210 mm altura.
- Fundo das gavetas protegido com tapete de borracha.
- 4 rodízios, Ø 125 mm:
- 2 fixos e 2 direcionáveis com travões.
- Fechadura centralizada de segurança frontal.
- Capacidade de carga estática: 1,100 kg.
- Plano de trabalho em madeira laminada com furos para fixação de um torno de bancada
(1599F/100 - 1599GI/100, opcional).
- Compartimento lateral com prateleira ajustável em altura.
- Porta-rolos de papel integrado.
- Porta-garrafas duplo traseiro.
- Porta-garrafas lateral integrado

80 kg

		€	↓	📄
RSC24L/7-O	RAL 2011	1.830,00	1	024004371
RSC24L/7-R	RAL 3000	1.830,00	1	024004373
RSC24L/7-A	RAL 7016	1.830,00	1	024004377

Beta RS 024

1100 kg



RSC24L/7-A



RSC24L/7-R



RSC24L/7-O

h	↓ max
70 mm	25 kg
140 mm	30 kg
210 mm	30 kg

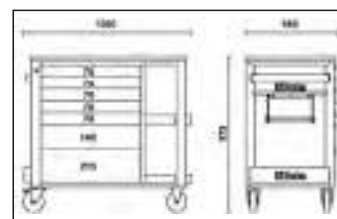

RSC24L-CAB

carro com 7 gavetas
e armário

Características principais:

- 7 gavetas (588x367 mm)
com guias de rolamentos de esfera:
- 5 gavetas, 70 mm altura
- 1 gaveta, 140 mm altura
- 1 gaveta, 210 mm altura.
- Fundo das gavetas protegido com tapete de borracha.
- 4 rodízios, Ø 125 mm:
- 2 fixos e 2 direcionáveis com travão.
- Fechadura centralizada de segurança frontal.
- Armário lateral com porta com fechadura e prateleira ajustável em altura.
- Capacidade de carga estática: 1,100 kg.
- Plano de trabalho em madeira laminada com furos para fixação de um torno de bancada
(1599F/100, opcional).
- Porta-rolos de papel integrado.
- Porta-garrafas duplo traseiro.
- Porta-garrafas lateral integrado

82 kg

		€	↓	📄
RSC24L-CAB/O	RAL 2011	1.890,00	1	024004471
RSC24L-CAB/R	RAL 3000	1.890,00	1	024004473
RSC24L-CAB/A	RAL 7016	1.890,00	1	024004477

Beta RS 024

1100 kg



RSC24L-CAB/A



RSC24L-CAB/R



RSC24L-CAB/O

h	↓ max
70 mm	25 kg
140 mm	30 kg
210 mm	30 kg

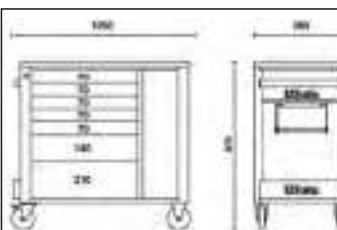

C04TSS-7

carro com sete gavetas, totalmente em aço inoxidável, rodas anti-marcas

Principais características:

- Sete gavetas (570 x 410 mm) com calhas assentes em rolamentos de esferas;
- 6 gavetas, 83 mm altura;
- 1 gaveta, 170 mm altura;
- 4 rodízios Ø 125 mm
- 2 fixos e 2 giratórios (dois com travão);
- Fechadura frontal centralizada;
- Estrutura totalmente fabricada em aço inoxidável
- Roletes, suportes, esferas, interiores de gavetas e calhas em aço inoxidável
- Pegas das gavetas em alumínio



700
kg



 63 kg

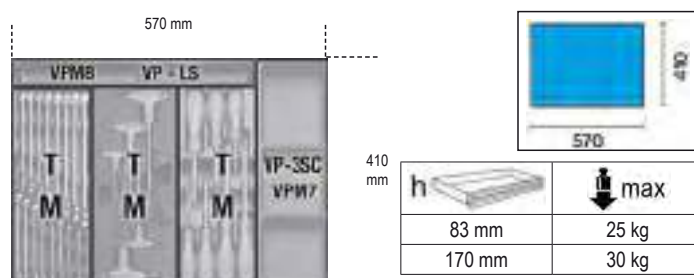

C04TSS/7

€ 2.870,00

1

024003077

303

C25

carro Tank com prateleiras

Características principais:

- 1 tabuleiro deslizante.
- Tampo desdobrável com fecho.
- Plano de alojamento das ferramentas protegido com tapete de borracha.
- Prateleiras protegidas por tapetes de borracha à prova de óleos e combustíveis.
- 4 rodas com diâmetro de 100 mm: 2 rodas fixas e 2 rodas giratórias (uma com travão).
- Fechadura de segurança.
- Módulo vazio para chaves de caixa e acessórios de 1/2" para chaves de caixa e acessórios de 1/2" (024990104).
- Possibilidade de aplicar o suporte para rolos de papel 2499PC.

 31,5 kg

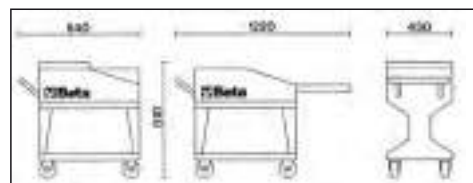

C25

€ 785,00

1

025000001

C27S

carro de ferramentas tipo trolley rebatível para trabalhos ao ar livre

Carro de ferramentas tipo trolley, com colunas rebateveis para transporte fácil. 2 gavetas, 588x277 mm, com guias de rolamentos de esferas para abertura nos dois sentidos.

Compartimento inferior de grandes dimensões, 588x277x220 mm.

Estrutura em metal.

2 rodízios fixos, Ø 160 mm, e 2 direccionáveis, Ø 100 mm (um com travão).

Plano de trabalho em termoplástico com 6 tabuleiros para ferramentas incluídos.

Fecho centralizado.

Pode ser equipado com divisórias para gavetas e tabuleiros soft

20 kg



C27S-O



C27S-G



C27S-R



h	max
70 mm	20 kg

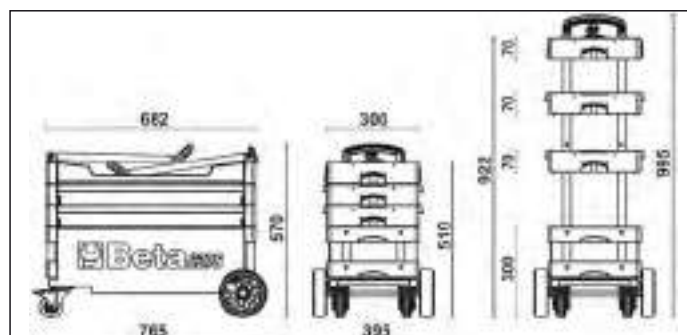
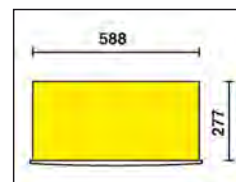

		€	↓	📄
C27S-O	RAL 2011	880,00	1	027000201
C27S-G	RAL 7016	880,00	1	027000202
C27S-R	RAL 3000	880,00	1	027000203

RSC28

trolley SuperTank com plano de trabalho em madeira e 10 gavetas

Características principais:

- 10 gavetas (588x367 mm) com guias de rolamentos de esfera.
- Sistema rápido e seguro para abertura e fecho das gavetas, frente em nylon com fibra de vidro.
- 5 gavetas laterais:
 - 4 gavetas, 70 mm altura
 - 1 gaveta, 210 mm altura.
- 5 gavetas frontais:
 - 4 gavetas, 70 mm altura
 - 1 gaveta, 210 mm altura.
- Fundo das gavetas protegido com tapete de borracha.
- 4 rodízios, Ø 150 mm:
 - 2 fixos e 2 direcionáveis com travões.
- 2 fechaduras frontais centralizadas.
- 3 gavetas frontais para ferramentas.
- Plano de trabalho em madeira laminada com furos para fixação de um torno de bancada (1599F/150 - 1599GI/150, opcional).
- Compartimento para ferramentas.
- Compartimento lateral com porta dobrável com fechadura.
- Porta-garrafas.
- Compartimento com 135 mm de altura com base revestida a plástico.
- Capacidade de carga estática: 1,200 kg.

1200 kg



RSC28-O

 130 kg



RSC28-A



RSC28-R



h	max
70 mm	25 kg
210 mm	30 kg

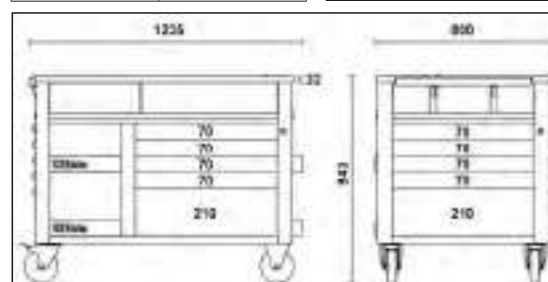

	€		
RSC28-O	3.310,00	1	028003001
RSC28-R	3.310,00	1	028003003
RSC28-A	3.310,00	1	028003007

C30M

bancada de trabalho móvel MaxiTank

Características principais:

- 5 gavetas frontais com guias de rolamentos de esfera:
- 3 gavetas (367x610 mm), 90 mm altura
- 1 gaveta (588x610 mm), 90 mm altura
- 1 gaveta (588x610 mm), 180 mm altura.
- Sistema de abertura rápida com frente em alumínio.
- Fundo das gavetas protegido com tapete de borracha.
- Pode ser equipado com bandejas flexíveis.
- Um macaco hidráulico, para elevar a parte frontal sem esforço, permitindo um transporte mais fácil.
- 4 rodízios:
- 2 direcionáveis à frente, Ø 150 mm
- 2 fixos atrás, Ø 170 mm.
- Plano de trabalho revestido a borracha resistente ao óleo, 1300x800 mm, com orifício de drenagem para recolha de fluidos num pequeno reservatório.
- Compartimento de arrumação, 720x250x1300 mm, com plano de trabalho revestido a PVC e painéis frontais deslizantes.
- Fechaduras centralizadas para gavetas e painéis.
- 3 porta-garrafas laterais.
- Porta-rolos de papel
- Capacidade de carga estática: 1,800 kg.
- Pode ser equipado com plano de trabalho em madeira (3000M/PLM), opcional
- Pode ser equipado com torno 1599F/150 (opcional).

1800
kg



200 kg

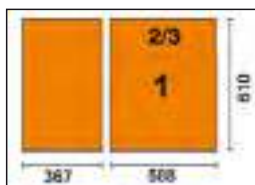

h	max
90 mm	30 kg
180 mm	35 kg

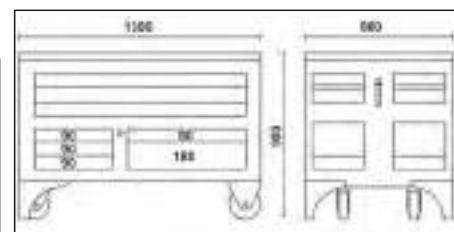

C30M

€ 5.300,00 1 030000300

3000M/PLM

plano de trabalho em madeira for C30M,
com furos para fixação de um torno de bancada (1599F/150)

10 kg



1240x740x26 mm

3000M/PLM

€ 515,00 1 030000350

FUNCIONAL E ROBUSTO



- Gavetas amovíveis
- Fechadura frontal centralizada
- Possibilidade de montagem de superfície de trabalho e de divisões de gavetas (a encomendar separadamente)
- Capacidade de carga estática: 1200 kg

Modelos disponíveis:

- C35/6GM (6 gavetas)
- C35/7GM (7 gavetas)
- C35/8GM (8 gavetas)
- C35/9GM (9 gavetas)

Acessórios disponíveis:



C35/6GM

armário de ferramentas industrial com 6 gavetas

Características principais:

- 6 gavetas amovíveis (600x447 mm):
 - 2 gavetas 75 mm altura
 - 1 gaveta 100 mm altura
 - 1 gaveta 150 mm altura
 - 1 gaveta 200 mm altura
 - 1 gaveta 300 mm altura
- Fechadura frontal centralizada
- Possibilidade de montagem de superfície de trabalho e divisórias de gavetas, a encomendar separadamente

75 kg

1200 kg



h	max
75 mm	70 kg
100 mm	70 kg
150 mm	70 kg
200 mm	70 kg
300 mm	70 kg

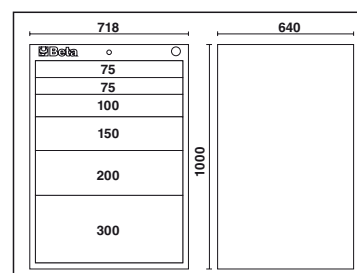
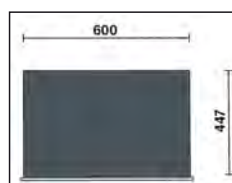

C35/6GM € 2.130,00 1 035000162

C35/7GM

armário de ferramentas industrial com 7 gavetas

Características principais:

- 7 gavetas amovíveis (600x447 mm):
 - 2 gavetas 75 mm altura
 - 1 gaveta 100 mm altura
 - 3 gavetas 150 mm altura
 - 1 gaveta 200 mm altura
- Fechadura frontal centralizada
- Possibilidade de montagem de superfície de trabalho e divisórias de gavetas, a encomendar separadamente

82 kg

C35/7GM € 2.220,00 1 035000172

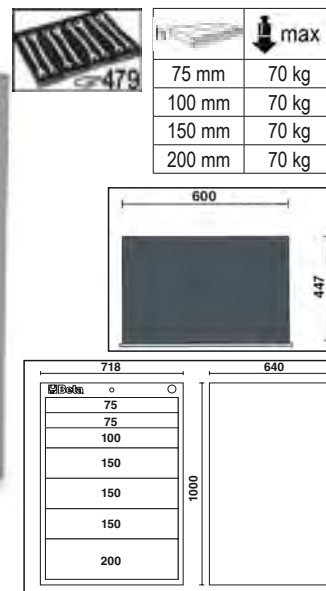

C35/8GM

armário de ferramentas industrial com 8 gavetas

Características principais:

- 8 gavetas amovíveis (600x447 mm):
 - 4 gavetas 75 mm altura
 - 1 gaveta 100 mm altura
 - 2 gavetas 150 mm altura
 - 1 gaveta 200 mm altura
- Fechadura frontal centralizada
- Possibilidade de montagem de superfície de trabalho e divisórias de gavetas, a encomendar separadamente

86 kg

C35/8GM € 2.370,00 1 035000182

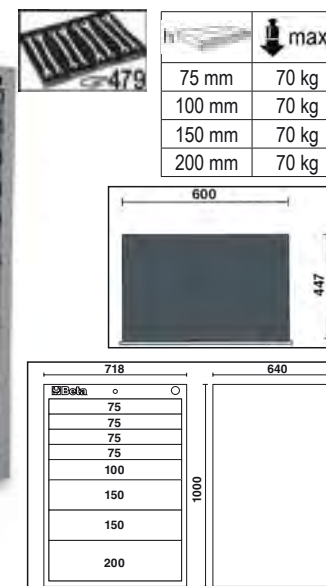

C35/9GM

armário de ferramentas industrial com 9 gavetas

Características principais:

- 8 gavetas amovíveis (600x447 mm):
 - 6 gavetas 75 mm altura
 - 3 gavetas 150 mm altura
- Fechadura frontal centralizada
- Possibilidade de montagem de superfície de trabalho e divisórias de gavetas, a encomendar separadamente

91 kg

C35/9GM € 2.480,00 1 035000192

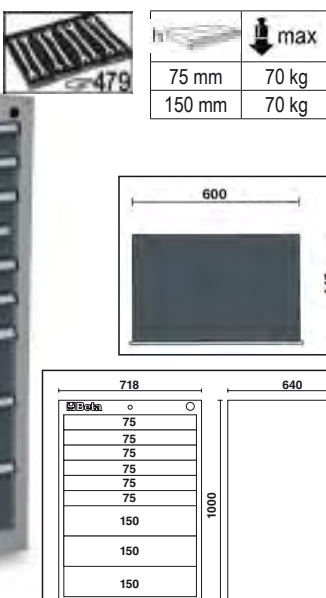

3500/P-M

superfície de trabalho com rebordo para armário de ferramentas C35

3500/P-M 700x600 mm € 414,00 1 035000505



PÁRA-CHOQUES

- Gavetas com guias de rolamentos de esferas
- Robusta superfície de trabalho multiusos
- Sistema de abertura rápida em alumínio, a todo o comprimento da gaveta
- Compartimentos e furos para chaves de fendas
- Quatro rodízios Ø 125 mm: 2 fixos e 2 giratórios (um com travão)
- Capacidade de carga estática: 1000 kg
- Pára-choques nos cantos a toda a altura do carro, para evitar danos aos veículos na garagem
- Fundos das gavetas protegidos com tapetes em espuma de borracha
- Fechadura frontal centralizada
- Porta-garrafas e porta-rolos de papel integrados, ajustáveis em várias posições

Cores disponíveis:

- C37/6 (6 gavetas)
- C37/7 (7 gavetas)
- C37/8 (8 gavetas)
- C37A/7 (7 gavetas com Sistema anti-queda)



Available colours:

O	RAL 2011
G	RAL 7016
R	RAL 3000

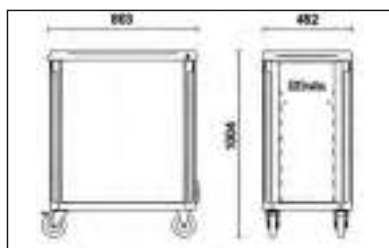

Acessórios disponíveis:



C37/7

carro de ferramentas com 7 gavetas

Características principais:

- 7 gavetas (588x367 mm) com guias de rolamentos de esferas:
- 5 gavetas 75 mm altura
- 1 gaveta 150 mm altura
- 1 gaveta 225 mm altura

71 kg

1000 kg



C37/7-O



C37/7-G



C37/7-R



	€	📦	🖨️
C37/7-O	1.450,00	1	037000071
C37/7-G	1.450,00	1	037000072
C37/7-R	1.450,00	1	037000073

h	max
75 mm	30 kg
150 mm	35 kg
225 mm	35 kg

C37/6

carro de ferramentas
com 6 gavetas

Características principais:

- 6 gavetas (588x367 mm) com guias de rolamentos de esferas:
- 4 gavetas 75 mm altura
- 1 gaveta 150 mm altura
- 1 gaveta 305 mm altura

1000
kg



C37/6-O

69 kg

	€	📦	🏠
C37/6-O	1.400,00	1	037000061
C37/6-G	1.400,00	1	037000062
C37/6-R	1.400,00	1	037000063



C37/6-G



C37/6-R



h	max
75 mm	30 kg
150 mm	35 kg
305 mm	40 kg



C37/8

carro de ferramentas
com 8 gavetas

Características principais:

- 8 gavetas (588x367 mm) com guias de rolamentos de esferas:
- 6 gavetas 75 mm altura
- 2 gavetas 150 mm altura

1000
kg



C37/8-O

73 kg

	€	📦	🏠
C37/8-O	1.500,00	1	037000081
C37/8-G	1.500,00	1	037000082
C37/8-R	1.500,00	1	037000083



C37/8-G



C37/8-R



h	max
75 mm	30 kg
150 mm	35 kg



C37A/7

carro com 7 gavetas,
com sistema anti-inclinação

Características principais:

- 7 gavetas (588x367 mm), com guias de rolamentos de esferas:
- 5 gavetas 75 mm altura
- 1 gaveta 150 mm altura
- 1 gaveta 225 mm altura

1000
kg



C37A/7-O

71 kg

	€	📦	🏠
C37A/7-O	1.490,00	1	037000271
C37A/7-G	1.490,00	1	037000272
C37A/7-R	1.490,00	1	037000273



C37A/7-G



C37A/7-R



h	max
75 mm	30 kg
150 mm	35 kg
225 mm	35 kg



3700/PLA

plano de trabalho em aço inox para carro de ferramentas item C37

📦 2,8 kg

3700/PLA € 84,00 1 037000100



3700/PLL

superfície de trabalho em madeira para carro C27

Possibilita montagem de torno (1599P/100, a encomendar separadamente)

📦 3,9 kg

3700/PLL € 106,00 1 037000101



≡ 672x396x28 mm

3700/PF

painel perfurado com suportes para carro de ferramentas item C37

📦 3,2 kg

3700/PF € 83,50 1 037000102



626
650



3700/PFL

painel lateral perfurado para carro de ferramentas item C37

📦 1,9 kg

3700/PFL € 44,50 1 037000104



754
321



3700/PC

suporte para computador para carro de ferramentas item C37

📦 3,1 kg

3700/PC € 114,00 1 037000103

303
418



C38

carro com 11 gavetas

Características principais:

- 11 gavetas com guias de rolamentos de esfera:
- 1 gaveta 937x410x122 mm
- 3 gavetas 570x410x74 mm
- 2 gavetas 570x410x153 mm
- 3 gavetas 313x410x74 mm
- 2 gavetas 313x410x153 mm.
- Fundo das gavetas protegido por tapete de borracha.
- Capacidade de carga estática: 1200 kg.
- 4 rodas de grande capacidade: Ø 125 mm:
- 2 fixas e 2 giratórias
- (ambas com alavanca de travão).
- Fechadura frontal de segurança centralizada.
- Plano superior em metal coberto com borracha baça.
- Pode-se instalar um porta rolos de papel referência 2499PC e um porta-garrafas referência 2499PF.

114 kg

	€	📦	🚚
C38-O	2.290,00	1	038000001
C38-G	2.290,00	1	038000003
C38-R	2.290,00	1	038000002



C38-G

C38-R

C38-O



h	max
74 mm	25 kg
153 mm	30 kg

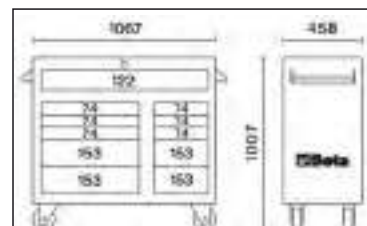
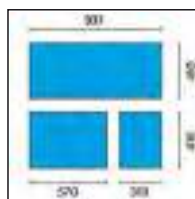

C38L

bloco lateral com 7 gavetas

Características principais:

- Sete gavetas (410x313 mm), com guias de rolamentos de esfera:
- 5 gavetas, 74 mm altura 2 gavetas, 153 mm altura
- Fundo das gavetas protegido com tapete de borracha.
- Fechadura frontal de segurança centralizada.
- Plano de trabalho em alumínio anti-deslizante.
- Pode ser colocado em ambos os lados do carro C38.

45 kg

	€	📦	🚚
C38L-O	1.110,00	1	038000081
C38L-G	1.110,00	1	038000083
C38L-R	1.110,00	1	038000082



C38L-O

C38L-G

C38L-R

h	max
74 mm	25 kg
153 mm	30 kg

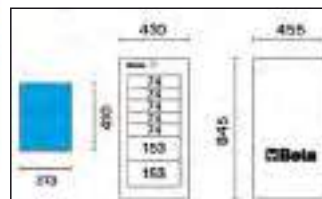

C38LA

armário lateral com porta e prateleira interior

Características principais:

- Fechadura frontal.
- Prateleira interior ajustável em altura.
- Bolsa para documentos no interior da porta.
- Plano de trabalho em alumínio antiderrapante.
- Pode ser montado em ambos os lados do carro C38.

18 kg

	€	📦	🚚
C38LA O	422,00	1	038000071
C38LA G	422,00	1	038000073
C38LA R	422,00	1	038000072



C38LA-O

C38LA-G

C38LA-R

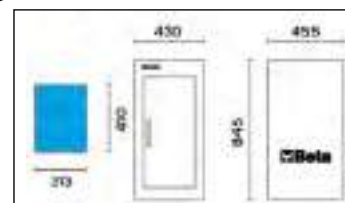

C38C

carro com 25 gavetas, composto por:

- 1 carro C38
- 2 blocos laterais C38L
- 1 bloco superior C38T

268 kg



C38C-O



C38C-G



C38C-R



h	max
74 mm	25 kg
153 mm	30 kg

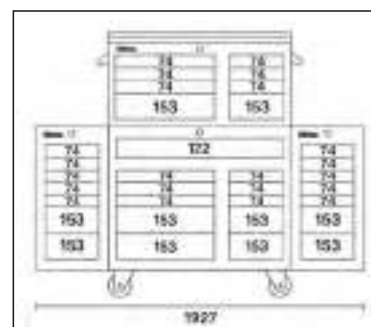
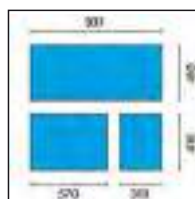

	€		
C38C-O	5.950,00	1	038000201
C38C-G	5.950,00	1	038000203
C38C-R	5.950,00	1	038000202

C38T

bloco superior com 8 gavetas e compartimento para ferramentas

Características principais:

- Oito gavetas com guias de rolamentos de esfera:
- 3 gavetas 570x410x74 mm
- 1 gaveta 570x410x153 mm
- 3 gavetas 313x410x74 mm
- 1 gaveta 313x410x153 mm
- Compartimento para ferramentas.
- Fundo das gavetas protegido com tapete de borracha.
- Fechadura frontal de segurança centralizada.
- Plano de trabalho em alumínio anti-deslizante.
- Pode ser colocado sobre o carro C38.

64 kg



C38T-O



C38T-G



C38T-R

h	max
74 mm	25 kg
153 mm	30 kg

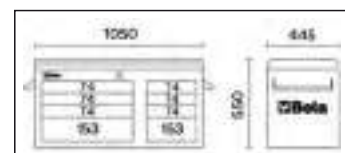
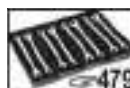

	€		
C38T-O	1.440,00	1	038000091
C38T-G	1.440,00	1	038000093
C38T-R	1.440,00	1	038000092

CARRO DE FERRAMENTAS C39

LATERAIS E PARTE FRONTAL DAS GAVETAS EM LIGA DE ALUMÍNIO + ROBUSTEZ + LEVEZA

- Gavetas com guias de rolamentos de esferas
- Superfície de trabalho termoplástica, concebida para suportar o baú de ferramentas portátil C39T
- Sistema de abertura rápida em alumínio, a todo o comprimento da gaveta
- Quatro rodízios Ø 125 mm: 2 fixos e 2 giratórios (um com travão)
- Capacidade de carga estática: 1200 kg
- Fundos das gavetas protegidos com tapetes em espuma de borracha
- Fechadura frontal centralizada
- Compartimentos e furos para chaves de fendas
- Porta-garrafas lateral e traseiro integrados
- Porta-rolos de papel integrado

Modelos disponíveis:

- C39/6 (6 gavetas)
- C39/7 (7 gavetas)
- C39/8 (8 gavetas)

Cores disponíveis:

	
O	RAL 2011
G	RAL 7016
R	RAL 3000

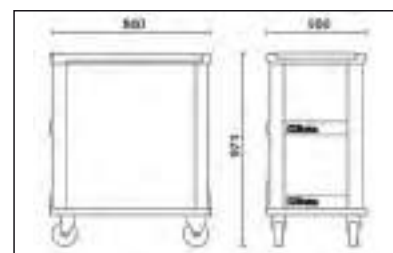

C39/7

carro com sete gavetas

Características principais:

- 7 gavetas (588x367 mm) montadas em guias telescópicas de esfera:
- 5 gavetas, 70 mm altura.
- 1 gaveta, 140 mm altura.
- 1 gaveta, 210 mm altura.

61 kg

1200 kg



C39-7/G



C39-7/R

C39-7/O

	€		
C39-7/O	2.180,00	1	039000001
C39-7/G	2.180,00	1	039000002
C39-7/R	2.180,00	1	039000003

h	max
70 mm	30 kg
140 mm	35 kg
210 mm	35 kg



C39/6

carro com 6 gavetas

Características principais:

- 6 gavetas (588x367 mm) com guias de rolamentos de esferas:

4 gavetas, 70 mm altura

1 gaveta, 140 mm altura

1 gaveta, 280 mm altura

1200
kg



C39-6/O



C39-6/G



C39-6/R



h	max
70 mm	30 kg
140 mm	35 kg
280 mm	40 kg



59 kg

	€		
C39-6/O	2.070,00	1	039000031
C39-6/G	2.070,00	1	039000032
C39-6/R	2.070,00	1	039000033

C39/8

carro com 8 gavetas

Características principais:

- 8 gavetas (588x367 mm) com guias de rolamentos de esferas:

6 gavetas, 70 mm altura

2 gavetas, 140 mm altura

1200
kg



C39-8/O



C39-8/G



C39-8/R



h	max
70 mm	30 kg
140 mm	35 kg



64 kg

	€		
C39-8/O	2.330,00	1	039000041
C39-8/G	2.330,00	1	039000042
C39-8/R	2.330,00	1	039000043

C39T

baú portátil para ferramenta com quatro gavetas

Características principais:

- 4 gavetas (588x367 mm) em guias de rolamentos de esferas:

4 gavetas, 70 mm altura

- Fecho centralizado frontal de segurança.

- Gaveta e perfis laterais em alumínio

29 kg

	€		
C39T-O	1.400,00	1	039000101
C39T-G	1.400,00	1	039000102
C39T-R	1.400,00	1	039000103



C39T-O



C39T-R

C39T-G



29 kg

h	max
70 mm	30 kg

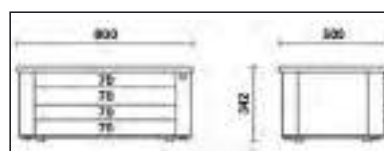

2400-COVER RSC24

capa de nylon para carros de ferramentas RSC24/A - C39

2400-COVER RSC24

€ 28,50 1 024000910



2400-COVER RSC24AXL

capa de nylon para carros de ferramentas RSC24A-XL, RSC24L, RSC24L-CAB

2400-COVER RSC24AXL

€ 38,50 1 024000930



3700-COVER C37

capa de nylon para carros de ferramentas item C37

3700-COVER C37

€ 37,00 1 037000930



The Beta logo is prominently displayed in the center, set against a background of various tools including wrenches, sockets, and screwdrivers, all rendered in a light, faded style.

C39SM

carro de ferramentas especial, tipo SM

Especificações

- Tampo em madeira prensada
- 4 rodas, Ø 125 mm
- 2 fixas e 2 giratórias (uma com travão), com protecção
- Capacidade de carga estática: 1200 kg

módulo 7 gavetas

- 588x367 mm, com calha de rolamentos de esferas:
- 6 gavetas, 70 mm altura
- 1 gaveta, 240 mm altura
- Base das gavetas protegida com tapete em borracha
- Fecho frontal centralizado
- Sistema de abertura ao comprimento total da gaveta
- Painel frontal da gaveta em alumínio

Módulo de serviço

- Caixa de lixo integrado
- Compartimento para rolo de papel
- 1 gaveta grande (420x305x270 mm)

125 kg

C39SM-O	RAL 2011	3.540,00	1	039390001
C39SM-G	RAL 7016	3.540,00	1	039390002
C39SM-R	RAL 3000	3.540,00	1	039390003



C39SM-G

C39SM-R

C39SM-O



h	max
70 mm	30 kg
240 mm	40 kg

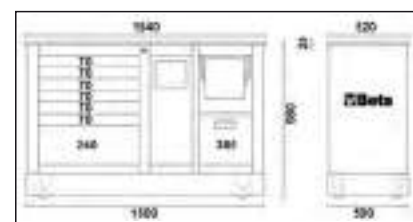

C39MD

carro de ferramentas especial, tipo MD

Especificações

- Tampo em madeira prensada
- 4 rodas, Ø 125 mm
- 2 fixas e 2 giratórias (1 com travão), com protecção
- Capacidade de carga estática: 1200 kg

módulo 7 gavetas

- 588x367 mm, com calhas assentes em rolamentos de esferas:
- 6 gavetas, 70 mm altura
- 1 gaveta, 240 mm altura
- Base das gavetas protegida com tapete em borracha
- Fecho frontal centralizado
- Sistema de abertura ao comprimento total da gaveta
- Painel frontal da gaveta em alumínio

módulo 2 gavetas

- 588x367x270 mm e 588x367x380 mm, com calhas assentes em rolamentos de esferas
- Base das gavetas protegida com tapete em borracha
- Fecho frontal centralizado
- Sistema de abertura ao comprimento total da gaveta
- Painel frontal da gaveta em alumínio

123 kg

C39MD-O	RAL 2011	3.650,00	1	039390101
C39MD-G	RAL 7016	3.650,00	1	039390102
C39MD-R	RAL 3000	3.650,00	1	039390103



C39MD-G

C39MD-R

C39MD-O



h	max
70 mm	30 kg
240 mm	40 kg

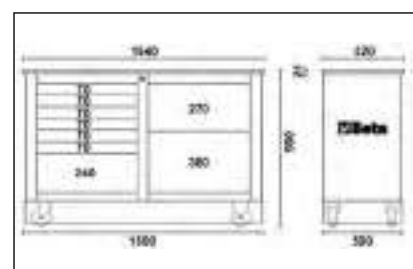

C41S

malas de ferramentas tipo trolley com dois módulos

Características principais:

- estrutura em metal e topos em plástico que garantem uma alta robustez e peso reduzido.
- 2 módulos separados:
 - 1 caixa de ferramentas,
 - 1 módulo com duas gavetas de 95 mm e 295 mm de altura respectivamente.
- Rodas com grande diâmetro (160 mm), para um transporte facilitado - por exemplo, em escadas.
- Fechadura lateral centralizada para fechar as gavetas do módulo de baixo.
- Gavetas montadas em guias telescópicas e com fechadura de ganchos duplos.
- Punho telescópico em alumínio
- Porta utensílios na caixa superior
- Gaveta inferior com extensão de duplo rolamento de esferas

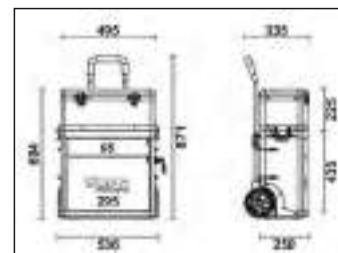
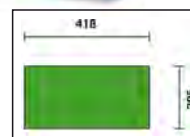

16 kg

C41S € 600,00 1 041000001

C41H

malas de ferramentas tipo trolley com dois módulos

Características principais:

- estrutura em metal e topos em plástico que garantem uma alta robustez e peso reduzido.
- 2 módulos removíveis:
 - 1 caixa de ferramentas,
 - 1 uma caixa removível de plástico, 66 mm altura, e 1 gaveta de 295 mm de altura.
- Rodas com grande diâmetro (160 mm), para um transporte facilitado - por exemplo, em escadas.
- Fechadura lateral centralizada para fechar as gavetas do módulo de baixo
- Gavetas montadas em guias telescópicas e com fechadura de ganchos duplos.
- Punho telescópico em alumínio
- Porta utensílios na caixa superior
- Gaveta inferior com extensão de duplo rolamento de esferas



C41H-O



C41H-W

C41H-Y

C41H-R

C41H-V

C41H-B

C41H-G

C41H-N

21 kg

		€		
C41H-O	RAL 2011	680,00	1	041000002
C41H-N	RAL 9005	680,00	1	041000005
C41H-B	RAL 5002	680,00	1	041000006
C41H-R	RAL 3000	680,00	1	041000008
C41H-G	RAL 7016	680,00	1	041000010
C41H-Y	RAL 1023	680,00	1	041000012
C41H-W	RAL 9016	680,00	1	041000021
C41H-V	RAL 6016	680,00	1	041000024

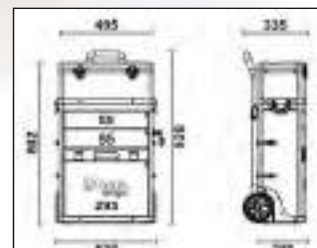
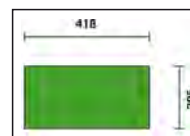

C41H/CE

caixa para ferramentas, com compartimentos para pequenas ferramentas removíveis, em material plástico

1,3 kg

C41H/CE € 42,50 1 041000916



C42H

Mala de ferramentas tipo trolley com três módulos

Características principais:

- Estrutura em metal e topos em plástico que garantem uma alta robustez e peso reduzido.
- 3 módulos removíveis:
 - 1 caixa de ferramentas superior, 220 mm altura
 - 1 módulo central, 180 mm altura,
 - 1 módulo inferior com rodas, 20 mm altura.
- Rodas de grande diâmetro (ø160 mm).
- Punho telescópico, ajustável em 3 posições.
- Sistema de desengate rápido dos módulos: acesso fácil e rápido a todos os compartimentos.
- Caixa de ferramentas superior com compartimento interno para ferramentas e 3 tabuleiros integrados na tampa.
- Pode ser utilizada apenas com 2 módulos.



14 kg

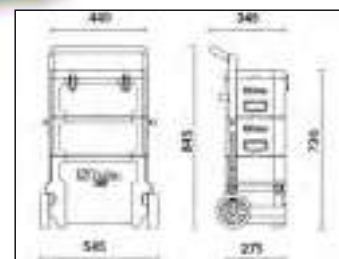

C42H

€ 482,00 1 042000002

Beta

CX49-G

trolley multiusos

pode ser usado como estação de trabalho móvel para ferramentas de diagnóstico, laptops, dispositivos de teste e carregadores de bateria.

- Estrutura em chapa pintada: firmeza e robustez incomparáveis
- Punho ergonómico
- Tampo 2 níveis
- Prateleira deslizante para teclado
- 2 prateleiras centrais com posição ajustável e 1 inferior fixa
- 4 práticos enroladores laterais em plástico
- 2 úteis compartimentos laterais
- 2 rodízios traseiros fixos Ø 160 mm
- 2 rodízios frontais giratórios Ø 100 mm (1 com travão)
- Peso: 36 kg

CX49-G € 895,00 1 049000102

1095 mm
495 mm
435 mm



CA49-G

Trolley multiusos com porta

Pode ser usado como estação de trabalho móvel para ferramentas de diagnóstico, laptops, dispositivos de teste e carregadores de bateria.

Características

- Estrutura em chapa pintada: firmeza e robustez incomparáveis
- Punho ergonómico
- Tampo 2 níveis
- Prateleira deslizante para teclado
- 1 prateleiras centrais com posição ajustável e 1 inferior fixa
- 4 práticos enroladores laterais em plástico
- 2 úteis compartimentos laterais
- 2 rodízios traseiros fixos Ø 160 mm
- 2 rodízios frontais giratórios Ø 100 mm (1 com travão)
- Peso: 36,5 kg

CA49-G € 1.010,00 1 049000112



1095 mm
495 mm
435 mm

4900-COVER C49

Capa em nylon, para trolley multiusos C49

4900-COVER C49 € 42,50 1 049000930



C48M

plataforma de carga elétrica, com painéis

As dimensões compactas e a versatilidade de utilização fazem da plataforma C48M a solução ideal para o manuseamento de cargas pesadas (caixas, bidons, objetos volumosos, peças de equipamentos) em total segurança, inclusive em áreas de difícil acesso e em ambientes de trabalho que não permitem o acesso através de empilhadores convencionais.

Isso resulta em riscos significativamente reduzidos para os operadores - por exemplo, distúrbios músculo-esqueléticos causados pela movimentação manual de cargas.

Plataforma motorizada, com motor 24V - 400W com alimentação a bateria 2x12V 33Ah e placa de controlo Curtis.

Piso de carga em aço resistente, revestido com borracha antiderrapante, com painéis tubulares redondos que impedem a queda de objetos durante o transporte.

Os painéis podem ser removidos para atender às necessidades individuais de transporte.

A consola de controlo está equipada com:

- chave de ignição
- botão de ajuste de velocidade
- punhos laterais para controlo de tração
- sinal sonoro intermitente, ativado ao fazer marcha-atrás
- indicador de carga da bateria
- botão de corte do travão elétrico
- botão de emergência.

Equipada com 2 rodas de tração pneumática (Ø 260 mm) e 2 rodas giratórias de borracha (Ø 150 mm), travão eletromagnético e caixa de diferencial. Fornecido com carregador de bateria externo, 220V/50Hz - V/A 24/12

ESPECIFICAÇÕES FUNCIONAIS

Capacidade de carga: 400 kg

Velocidade de condução: 4-6 km/h (ajustável)

Duração da bateria: 4 horas

Inclinação máxima permitida com carga total: 6%

Inclinação máxima permitida com carga de 100 kg: 18%

Travão eletrónico

Buzina

Proteção anti-esmagamento

Indicador de carga da bateria

Sistema de controlo Curtis

ESPECIFICAÇÕES TÉCNICAS

Dimensões gerais: 1280x630x1100h mm

Dimensões úteis da plataforma de carga com painéis: 1180x580 mm

Dimensões úteis da plataforma de carga sem painéis: 1260x620 mm

Altura da plataforma de carga em relação ao chão: 320 mm

Altura do compartimento da bateria em relação ao chão: 65 mm

Peso com baterias: 140 kg

140 kg

C48M

€ 3.260,00 1 048000230

C48P

carro de ferramentas dobrável

Características:

- Plataforma de carga em polipropileno reforçado (PP), com revestimento antiderrapante e inserções TPV para proteção dos cantos
- Pega retrátil para arrumação fácil e rápida
- Quatro rodízios antimarcas, Ø 125 mm: 2 fixos e 2 giratórios com travões
- Capacidade máxima: 300 kg
- Largura útil da plataforma de carga: 705 mm
- Profundidade plataforma de carga: 480 mm
- Altura plataforma de carga: 200 mm



280 mm



11 kg

C48P

€ 307,00 1 048000030

Beta
BRUTUS

400 kg

CE



1100
630
1280



300 kg

C51

carro

- 3 planos cobertos com borracha estriada anti-deslizante
- Punho de transporte ergonômico
- Duas opções de fixação de posto de trabalho superior
- Quatro rodas Ø 100 mm: 2 fixas e 2 giratórias (1 com travão)
- Capacidade de carga, parado: 200 kg (distribuídos pelas 3 prateleiras)

21 kg



		€		
C51 O	RAL 2011	342,00	1	051000001
C51 G	RAL 7016	342,00	1	051000002
C51 R	RAL 3000	342,00	1	051000003

RSC51

carro com 3 gavetas

Principais características:

- Superfície de trabalho em ABS reforçado, sólida e robusta
- Tampo multiusos com arestas anti-queda e 8 furos para chaves de fendas
- 3 gavetas (588x367 mm) com guias de rolamentos de esferas, 70 mm altura
- Bases das gavetas protegidas por tapetes em borracha
- Cada gaveta pode acomodar até 4 tabuleiros maleáveis em EVA ou ABS
- Fechadura de segurança frontal centralizada
- Conveniente apoio lateral para chave de fendas integrado
- Dois suportes laterais integrados para latas de spray
- Grande prateleira inferior protegida por tapete à prova de petróleo/gasolina
- 4 rodízios, Ø 125 mm: 2 fixos e 2 giratórios (um com travão)

- Capacidade de carga estática: 400 kg
- Capacidade de cada gaveta: 15 kg, distribuídos de forma equilibrada



38 kg



h	max
70 mm	15 kg

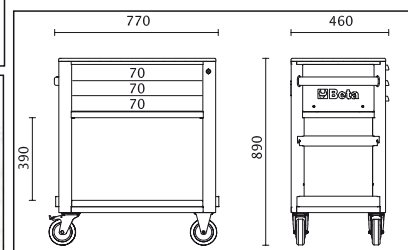

		€		
RSC51-FO	RAL 2011	685,00	1	051000300
RSC51-R	RAL 3000	685,00	1	051000303
RSC51-A	RAL 7016	685,00	1	051000307

2400 RSC24/MP

prateleira dobrável para artigos RSC24, RSC24A, RSC24AXLP/7, RSC51

- Para utilização como superfície de trabalho adicional
- Dimensões superfície de trabalho: 390x440 mm, com tapete de borracha à prova de gasóleo e gasolina
- Capacidade de carga: 20 kg

📦 3,4 kg

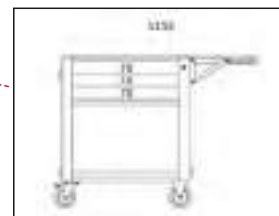

2400 RSC24/MP

€ 85,50 1 024004900

CP51

mala de ferramentas tipo trolley robusta

- 2 planos cobertos com borracha estriada anti-deslizante
- Punho de transporte ergonómico
- 4 rodas Ø 125 mm:
2 fixas e 2 giratórias com travão
- Capacidade de carga: 750 kg (distribuído pelas 2 praticados)

📦 37 kg

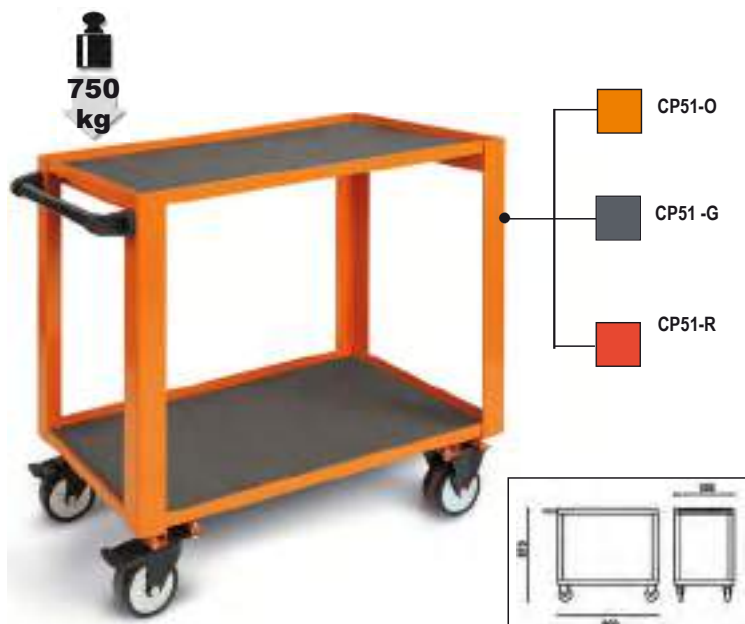

		€	📦	📄
CP51 O	RAL 2011	452,00	1	051000501
CP51 G	RAL 7016	452,00	1	051000502
CP51 R	RAL 3000	452,00	1	051000503

CB52

bancada com rodas para caixas de velocidades/transmissões com sistema de recuperação de líquidos
Inclinação e furos de drenagem para recuperação de líquidos em depósito coletor

Equipada com:

- 4 rodízios giratórios, 2 com travões
- gaveta para ferramentas
- depósito coletor de líquido; capacidade: 7 l
- 2 prateleiras

Dimensões: 1200x640x870 mm
Peso: 60 kg

📦 60 kg



		€	📦	📄
CB52-O		865,00	1	052000201

C56P O

bancada de trabalho dobrável

Compacta e fácil de transportar.

Tampo 800x500mm, em MDF e chapa de ferro galvanizada com 30 mm espessura; possibilidade de utilização em ambos os lados.

Pega com revestimento em borracha para fácil transporte.

Pés anti-derrapantes.

Capacidade estática de carga: 250 kg

📦 25 kg

📦
250
kg

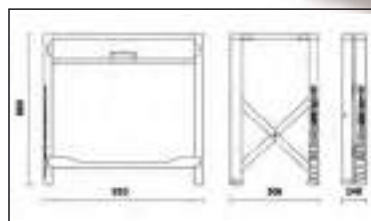

C56P O

€ 476,00 1 056000011

C56PL O

Bancada de trabalho rebatível, versão leve

Leve, compacta, fácil de transportar.

Tampo (800x500mm) em chapa de ferro galvanizado, protegida por cobertura de borracha resistente ao óleo e combustíveis (para utilização apenas de 1 lado)

Pega com revestimento em borracha para fácil transporte.

Pés anti-derrapantes.

Capacidade estática de carga: 200 kg

📦 18,5 kg

📦
200
kg

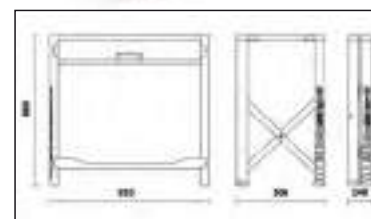

C56PL O

€ 411,00 1 056000021

C54S

armários Cargo

Concebidos a partir de diversos inquéritos efectuados a utilizadores profissionais, oferecem algumas das soluções para operar de um modo confortável e racional. Painéis perfurados apoiados sobre dobradiças no interior das portas para que seja possível usufruir do espaço proporcionado pela superfície interior.

Características principais:

- 1 gaveta montada sobre guias telescópicas.
 - Grande facilidade em efectuar alterações estruturais para encontrar a melhor solução para cada caso específico.
 - Fixação à parede através de duas cavidades existentes no painel posterior ou como solução móvel
- possibilidade de fixação através de dois parafusos a um carro Team C50.
- Fechadura simultânea de segurança para portas e gavetas.
 - Módulos de gavetas vazios com inserts para chaves de caixa e acessórios de 1/2".



C54S-O

37 kg

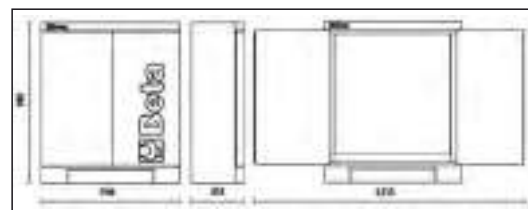

C54S-O

RAL 2011

€ 865,00



1



054000301

 **Beta**

C57SA

bancada de trabalho MasterCargo

- Modelo com armário (C57P) e um bloco de gavetas.

Bloco de gavetas composto por 5 gavetas, 588x367 mm, 3 de 90 mm altura, 1 de 180 mm altura e 1 de 280 mm altura, com guias de rolamentos de esferas. Pode ser equipada com tabuleiros. Fecho centralizado.

Painel para ferramentas, com orifícios para fixação à parede. Persiana em alumínio com fechadura de segurança. Três painéis perfurados amovíveis para ferramentas.

Plano de trabalho em madeira laminada plastificada, com três orifícios para torno ref. 1599F/150 - 1599GI/150, extra opcional.



C57SA-O

205 kg



C57SA-G

C57SA-R

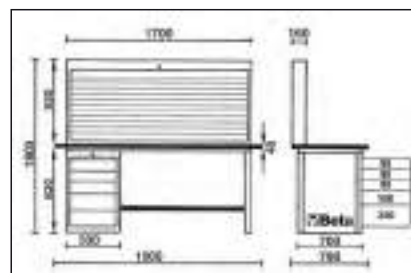

h	max
90 mm	30 kg
180 mm	40 kg
280 mm	40 kg

		€		
C57SA-O	RAL 2011	5.450,00	1	057001005
C57SA-G	RAL 7016	5.450,00	1	057001205
C57SA-R	RAL 3000	5.450,00	1	057001405

C57SD

bancada de trabalho MasterCargo

- Modelo com um bloco de gavetas.

Bloco de gavetas composto por 5 gavetas, 588x367 mm, 3 de 90 mm altura, 1 de 180 mm altura e 1 de 280 mm altura, com guias de rolamentos de esferas. Pode ser equipada com tabuleiros. Fecho centralizado.

Plano de trabalho em madeira laminada, plastificada, com três orifícios para torno ref. 1599F/150 - 1599GI/150, extra opcional.



C57SD-O



h	max
90 mm	30 kg
180 mm	40 kg
280 mm	40 kg

158 kg

		€		
C57SD-O	RAL 2011	3.830,00	1	057001004
C57SD-G	RAL 7016	3.830,00	1	057001204
C57SD-R	RAL 3000	3.830,00	1	057001404



C57SD-G

C57SD-R

C57SB

bancada de trabalho MasterCargo

- Modelo com armário (C57P) e dois blocos de gavetas.

Bloco de gavetas composto por 5 gavetas, 588x367 mm, 3 de 90 mm altura, 1 de 180 mm altura e 1 de 280 mm altura, com guias de rolamentos de esferas. Pode ser equipada com tabuleiros. Fecho centralizado.

Painel para ferramentas, com orifícios para fixação à parede. Persiana em alumínio com fechadura de segurança.

Três painéis perfurados amovíveis para ferramentas.

Plano de trabalho em madeira laminada plastificada, com três orifícios para torno ref. 1599F/150 - 1599GI/150, extra opcional.

 **1800 kg**



C57S/B-O

 **243 kg**



C57S/B-G



C57S/B-R



h	max
90 mm	30 kg
180 mm	40 kg
280 mm	40 kg

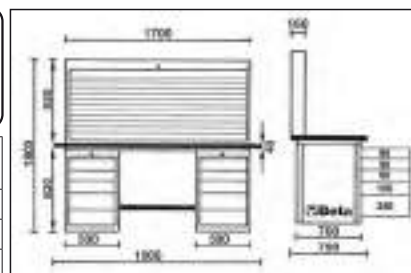

		€		
C57S/B-O	RAL 2011	6.750,00	1	057001006
C57S/B-G	RAL 7016	6.750,00	1	057001206
C57S/B-R	RAL 3000	6.750,00	1	057001406

C57SC

bancada de trabalho MasterCargo

- Modelo com dois blocos de gavetas.

Bloco de gavetas composto por 5 gavetas, 588x367 mm, 3 de 90 mm altura, 1 de 180 mm altura e 1 de 280 mm altura, com guias de rolamentos de esferas. Pode ser equipada com tabuleiros. Fecho centralizado.

Plano de trabalho em madeira laminada, plastificada, com três orifícios para torno ref. 1599F/150 - 1599GI/150, extra opcional.

 **1800 kg**



h	max
90 mm	30 kg
180 mm	40 kg
280 mm	40 kg



C57S/C-O

 **196 kg**

		€		
C57S/C-O	RAL 2011	5.200,00	1	057001003
C57S/C-G	RAL 7016	5.200,00	1	057001203
C57S/C-R	RAL 3000	5.200,00	1	057001403



C57S/C-G



C57S/C-R

C57SP

Armário para ferramentas

Armário para ferramentas, com dois orifícios para fixação à parede.
Persiana em alumínio com fecho de segurança.
Três painéis perfurados amovíveis para fixação de ferramentas com ganchos.

46 kg

		€		
C57SP-O	RAL 2011	1.600,00	1	057001020
C57SP-G	RAL 7016	1.600,00	1	057001220
C57SP-R	RAL 3000	1.600,00	1	057001420



C57SP O

1700 mm

930 mm



560



C57SP G



C57SP R

5700LAMP

lâmpada para bancada MasterCargo

- Estrutura robusta constituída por quatro elementos metálicos e fornecimento dos parafusos de fixação.
- Suporte de lâmpada com lâmpada LED 1120-lumen, 4000K, 14W.
- Alimentação 230V.
- Fornecido sem cabo.

9 kg

	€		
5700LAMP	393,00	1	057000005



5700LAMP + C57S/A-O

C58P

painel para ferramentas

- Persiana em alumínio pintado com fechadura.
- Dois painéis de ferramentas perfurados amovíveis.

46,8 kg

		€		
C58P-O	RAL 2011	1.210,00	1	058000221
C58P-G	RAL 7016	1.210,00	1	058000222
C58P-R	RAL 3000	1.210,00	1	058000223



C58P-G



C58P-R

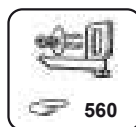

560



C58P-O

1360 mm

930 mm

PV

painel para ferramentas

	LxA		€		
	mm				
PV1	1000x920	10,2	226,00	1	088880010
PV1,5	1500x920	14,2	299,00	1	088880015



560



C56W

bancada de trabalho com tampo em madeira

- Tampo em contraplacado com orifícios para torno (1599F/125 - 1599GI/125, opcional).
- Estrutura em aço com 6 pernas de apoio
- Capacidade de carga, estacionária: 1,200 kg
- Adaptável ao painel de ferramentas C57P; não pode ser fixo na superfície de trabalho.
- Duas gavetas com fechadura.
- Possibilidade de fixação ao solo.

📦 86 kg



		€	📦	🖨️
C56W-O	RAL 2011	1.330,00	1	056000251
C56W-G	RAL 7016	1.330,00	1	056000252
C56W-R	RAL 3000	1.330,00	1	056000253

C56B

bancada de trabalho com tampo em madeira

Características principais:

- Tampo em contraplacado com orifícios para torno (1599F/125 - 1599GI/125, opcional).
- Estrutura em aço com 4 pernas de apoio.
- Capacidade de carga estática: 800 kg.
- Prateleira inferior.
- Possibilidade de fixação ao solo.

📦 54,5 kg



		€	📦	🖨️
C56B-O	RAL 2011	795,00	1	056000401
C56B-G	RAL 7016	795,00	1	056000402
C56B-R	RAL 3000	795,00	1	056000403

C56

bancada de trabalho

- Plano de trabalho em chapa galvanizada com rebordos salientes
- Estrutura em aço com 6 pernas de suporte
- Capacidade de carga estática: 1.200 kg
- Compatível com armário para ferramentas C57P; não permite fixação ao plano de trabalho
- Duas gavetas com fechadura
- Pode ser fixo ao pavimento

📦 82 kg



		€	📦	🖨️
C56-O	RAL 2011	1.130,00	1	056000201
C56-G	RAL 7016	1.130,00	1	056000202
C56-R	RAL 3000	1.130,00	1	056000203

C56M

bancada de trabalho

- Plano de trabalho em folha de alumínio e tapete de borracha anti-deslizamento.
- Capacidade de carga: kg.800.
- Pode ser instalado um armário para ferramentas C57P.
- Três gavetas com fechadura.

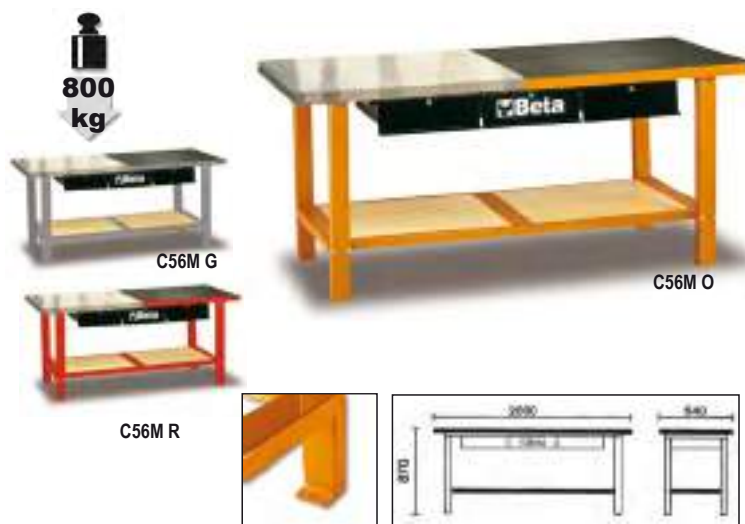

95 kg

		€		
C56M O	RAL 2011	1.620,00	1	056000050
C56M G	RAL 7016	1.620,00	1	056000053
C56M R	RAL 3000	1.620,00	1	056000054

C58B

bancada de trabalho com tampo em madeira

Características principais:

- Tampo em contraplacado com orifícios para torno (1599F/125 - 1599GI/125, opcional).
- Estrutura em aço com 4 pernas de apoio.
- Capacidade de carga estática: 800 kg.
- Prateleira inferior.
- Possibilidade de fixação ao solo.

44 kg



		€		
C58B-O	RAL 2011	710,00	1	058000401
C58B-G	RAL 7016	710,00	1	058000402
C58B-R	RAL 3000	710,00	1	058000403

C58M

bancada de trabalho

- Plano de trabalho metálico totalmente coberto com tapete de borracha antiderrapante amovível.
- Prateleira inferior em madeira maciça.
- Capacidade de carga estática: 800 kg
- Pode combinar com o painel de ferramentas C58P; não se pode fixar ao plano de trabalho.
- 2 gavetas com fechadura.
- Pode fixar-se ao pavimento.
- Plano de trabalho em alumínio C58M/PA. Disponível a pedido.

65 kg



		€		
C58M-O	RAL 2011	1.040,00	1	058000300
C58M-G	RAL 7016	1.040,00	1	058000302
C58M-R	RAL 3000	1.040,00	1	058000303

C59A

Bancada de trabalho "Endurance" com 1 módulo com 6 gavetas

Características principais:

- Tampo em madeira prensada com orifícios para torno ref. 1599F/125 - 1599GI/125 (opcional extra).
- 6 gavetas (588x367 mm) com guias de rolamentos de esferas:
 - 4 gavetas, 70 mm altura (capacidade máx.: 25 kg)
 - 1 gaveta, 140 mm altura (capacidade máx.: 30 kg)
 - 1 gaveta, 280 mm altura (capacidade máx.: 35 kg)
- Base das gavetas protegida com tapete em borracha.
- Pannel frontal das gavetas em nylon.
- As gavetas podem ser equipadas com tabuleiros.
- Fecho frontal centralizado.
- Prateleira inferior.
- Pode ser equipada com suporte para rolo de papel (2400 RSC24/PC) e porta-garrafas (2400 RSC24/PF-), extras opcionais.

115 kg



C59A O



C59A A



C59A R

1500 kg



h	max
70 mm	25 kg
140 mm	30 kg
280 mm	35 kg

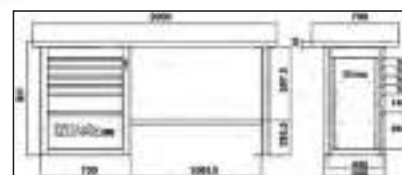

		€		
C59A-O	RAL 2011	2.140,00	1	059000011
C59A-A	RAL 7016	2.140,00	1	059000031
C59A-R	RAL 3000	2.140,00	1	059000051

C59B

Bancada de trabalho "Endurance" com 2 módulos com 6 gavetas

Características principais:

- Tampo em madeira prensada com orifícios para torno ref. 1599F/125 - 1599GI/125 (extra opcional).
- 12 gavetas (588x367 mm) com guias de rolamentos de esferas:
 - 8 gavetas, 70 mm altura
 - 2 gavetas, 140 mm altura
 - 2 gavetas, 280 mm altura
- Base das gavetas protegida com tapete em borracha.
- As gavetas podem ser equipadas com tabuleiros.
- Fecho frontal centralizado.
- Prateleira inferior.
- Pode ser equipada com suporte para rolo de papel (2400 RSC24/PC) e porta-garrafas (2400 RSC24/PF-), extras opcionais.

155 kg

1500 kg



C59B O



C59B A



C59B R

h	max
70 mm	25 kg
140 mm	30 kg
280 mm	35 kg

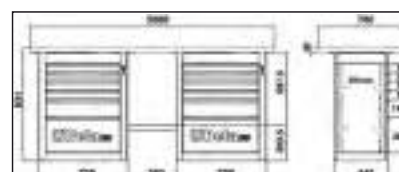

		€		
C59B-O	RAL 2011	2.840,00	1	059000012
C59B-R	RAL 3000	2.840,00	1	059000052
C59B-A	RAL 7016	2.840,00	1	059000032

C59C

Bancada de trabalho "Endurance" com 1 módulo com 6 gavetas, modelo curto

Características principais:

- Tampo em madeira prensada com orifícios para torno ref. 1599F/125 - 1599GI/125 (extra opcional).
- 6 gavetas (588x367 mm) com guias de rolamentos de esferas:
4 gavetas, 70 mm altura
1 gaveta, 140 mm altura
1 gaveta, 280 mm altura
- Base das gavetas protegida com tapete em borracha.
- As gavetas podem ser equipadas com tabuleiros.
- Fecho frontal centralizado.
- Prateleira inferior.
- Pode ser equipada com suporte para rolo de papel (2400 RSC24/PC) e porta-garrafas (2400 RSC24/PF-), extras opcionais.



105 kg

		€	📦	🏠
C59C-O	RAL 2011	1.930,00	1	059000013
C59C-R	RAL 3000	1.930,00	1	059000053
C59C-A	RAL 7016	1.930,00	1	059000033

h	max
70 mm	25 kg
140 mm	30 kg
280 mm	35 kg

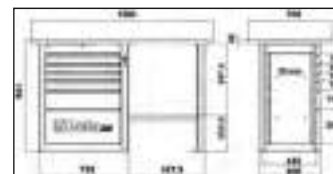

9562T2

tapete para bancada de trabalho, 200x160 cm

- protege o chão de derrames de óleo e combustível, respeita o meio ambiente
- limpeza fácil, parte de trás antiderrapante em borracha



	L cm	€	📦	🏠
9562T2	200	248,00	1	095620200

 **Beta**



MOBILIÁRIO PARA OFICINA



No sentido de dar resposta aos requisitos de um mercado cada vez mais exigente no que se refere à qualidade, design e especificidade, a Beta Utensili desenvolveu o "Racing System C55", mobiliário modular para oficina à medida das suas necessidades, permitindo-lhe criar um espaço de trabalho moderno.

Qualidade

A melhor qualidade italiana BETA para equipar a sua oficina



Design

Acabamentos perfeitos para um posto de trabalho organizado e atractivo

Organização

Um posto de trabalho organizado, sinónimo de trabalho optimizado

Modularidade

Mobiliário modular para oficina, adequado ao seu espaço e às suas necessidades





MADE IN ITALY

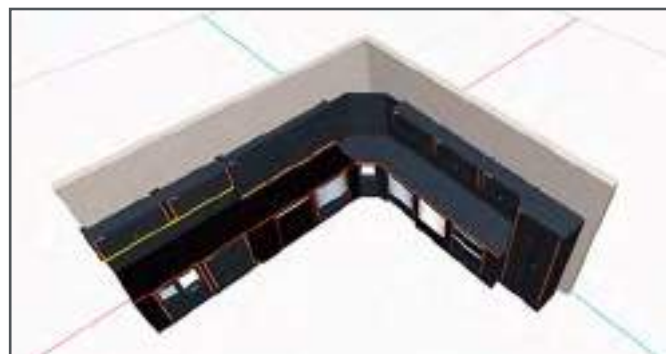

Aceda a **www.rsc55.com**
para configurar a sua oficina online



As suas cores para a sua oficina!

O RSC55 permite-lhe organizar o Sistema de bancadas e painel de parede com persiana em versão neutra (cinza) e personalizar os inserts verticais coloridos, escolhendo entre 7 fitas adesivas distintas.

**1. Organize os seus
módulos numa cor neutra**

2. Organize o insert vertical

Escolha uma cor que lhe agrade
ou de acordo com as cores da sua empresa

C55

estante para oficina



Conjunto completo incluindo:

- Armário de uma porta (C55A1)
- Armário de duas portas (C55A2)
- Bancada de trabalho (C55BO/2)
- Bancada de trabalho com tomadas (C55PRO BO/2)
- Carro com 7 gavetas (C55C7)
- Módulo fixo com 2 gavetas de arrumação (C55M2)
- Módulo fixo com 7 gavetas (C55M7)
- Módulo de serviço fixo (C55MS)
- Painel de ferramentas com armários suspensos (C55/2PM)
- Painel de ferramentas com persiana (C55PS-O)

C55AB

estante para oficina

Módulo incluindo:

- Armário de duas portas (C55A2)
- Bancada de trabalho (C55BO/2)
- Módulo fixo com 7 gavetas (C55M7)
- Módulo de serviço fixo (C55MS)
- Painel de ferramentas com armários suspensos (C55/2PM)

407 kg



C55AB

€ 10.200,00 1 055000020



C55PB/3

estante para oficina

Conjunto inclui:

- Bancada de trabalho (C55BO/2)
- Carro com 8 gavetas (C55C8)
- Módulo fixo com 2 gavetas (C55M2)
- Painel de ferramentas com persiana (C55PS-O)

334 kg



C55PB/3

€ 8.600,00 1 055000035



C55PB-PRO/7

bancada de trabalho, a combinar com mobiliário para oficina RSC55

Composição:

C55B

Bancada de trabalho com tampo (2050x700 mm) com revestimento ABS anti-impacto e anti-riscos, resistente a óleos e hidrocarbonetos.

Equipada com:

- Furos para torno (1599F/150, opcional)
- Pés com regulação vertical

C55M7

Módulo fixo com 7 gavetas (588x367 mm) com guias de rolamentos de esferas

- Sistema de abertura em alumínio a todo o comprimento da gaveta
- Bases das gavetas com tapetes de proteção em borracha
- Fechadura frontal centralizada
- Pode ser equipado com tabuleiros flexíveis

C55MS

Módulo de serviço fixo

- Caixa de lixo incorporado
- Compartimento para rolo de papel
- Gaveta, 305x270 mm

C55/2PM + C55/PF

Painel de ferramentas com 2 armários suspensos

- 2 armários suspensos, 1024x400x300 mm, com molas de gás
- 2 painéis de ferramentas, 1024x620x25 mm
- 2 painéis de ferramentas perfurados, 1024x620x25 mm

📦 350 kg



C55PB-PRO/7

€ 9.600,00 1 055000065



C55PB-PRO/8

bancada de trabalho, a combinar com mobiliário para oficina RSC55

Composição:

C55B

Bancada de trabalho com tampo (2050x700 mm) com revestimento ABS anti-impacto e anti-riscos, resistente a óleos e hidrocarbonetos.

Equipada com:

- Furos para torno (1599F/150, opcional)
- Pés com regulação vertical

C55C7

Carro com 7 gavetas (588x367 mm) com guias de rolamentos de esferas

- 4 rodízios Ø 100 mm, 2 fixos e 2 giratórios (um com travão)
- Sistema de abertura em alumínio a todo o comprimento da gaveta
- Bases das gavetas com tapetes de proteção em borracha
- Fechadura frontal centralizada
- Pode ser equipado com tabuleiros flexíveis

C55MA

Módulo fixo com 2 portas

- Sistema de abertura push-pull
- Fechadura
- Prateleira interior ajustável

C55PS

Painel de ferramentas com persiana

- Persiana em alumínio, com regulação vertical e fechadura
- Painel de ferramentas perfurado e amovível

📦 347 kg



C55PB-PRO/8

€ 8.300,00 1 055000066



C55B/2

bancada de trabalho com 2 m de comprimento, para combinar com mobiliário de oficina

Bancada (2050x700 mm) com tampo revestido a PVC anti-riscos e anti-impacto, resistente a hidrocarbonetos

- Furos para fixação de torno (1599F/150 - 1599GI/150, opcional)
- Pés com regulação vertical

105 kg

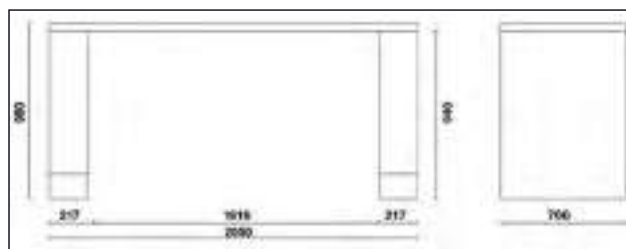
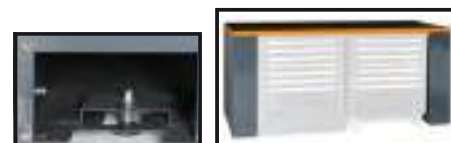
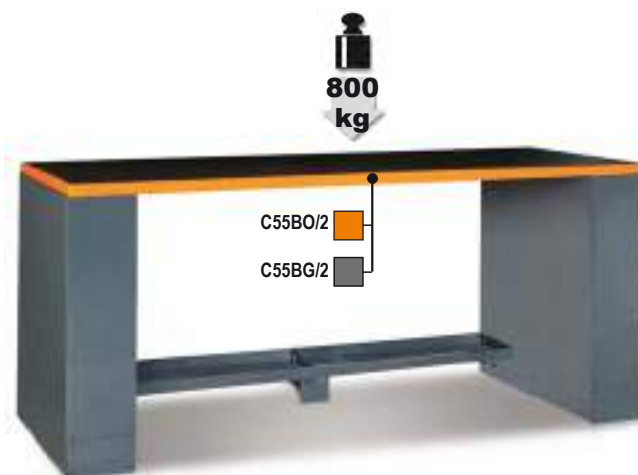

	€		
C55BO/2	2.360,00	1	055000101
C55BG/2	2.360,00	1	055000111

C55PRO B/2

bancada de trabalho com 2 m de comprimento, para combinar com mobiliário de oficina

Bancada (2050x700 mm) com tampo revestido a PVC anti-riscos e anti-impacto, resistente a hidrocarbonetos

Fichas e enrolador integrados:

- Tomada Schuko+16+10A
- Tomada EU +10A
- Bocal de saída do ar comprimido com enrolador, Ø 8 mm, comp.: 10 m.
- Furos para fixação de torno (1599F/150 - 1599GI/150, opcional)
- Pés com regulação vertical

110 kg

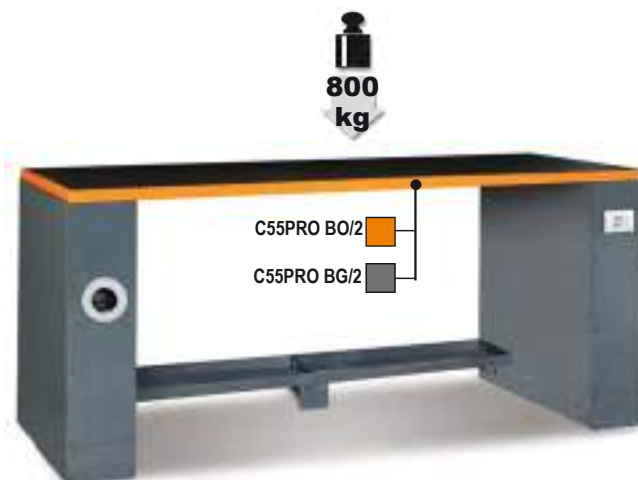

	€		
C55PRO BO/2	2.900,00	1	055000151
C55PRO BG/2	2.900,00	1	055000171

C55B/2,8

bancada 2.8 m comprimento, para combinar com mobiliário de oficina

- Bancada de trabalho (2850x700 mm) com tampo revestido a PVC anti-riscos e anti-impacto, resistente a hidrocarbonetos
- Com furos para fixação do torno (1599F/150 - 1599GI/150, extra opcional)
- Pés com regulação vertical

129 kg

600 kg

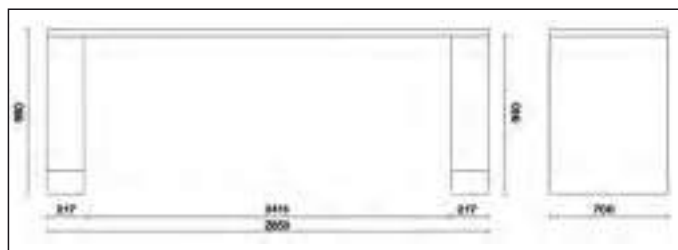
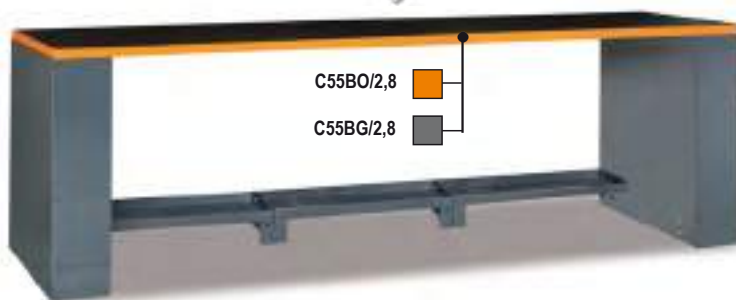

C55BO/2,8	€ 2.970,00	1	055000261
C55BG/2,8	€ 2.970,00	1	055000281

C55PRO B/2,8

bancada com 2,8 m de comprimento, para combinar com mobiliário de oficina

Bancada de trabalho (2850x700) com tampo revestido a PVC anti-riscos e anti-impacto, resistente a hidrocarbonetos

Fichas e enrolador integrados:

- Tomada Schuko+16+10A
- Tomada 10A
- Bocal saída de ar comprimido com enrolador, Ø 8 mm, comp.: 10 m.
- Furos para fixação de torno (1599F/150 - 1599GI/150, opcional)
- Pés com regulação vertical

134 kg

600 kg

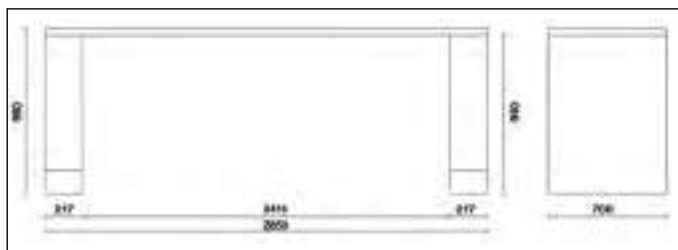
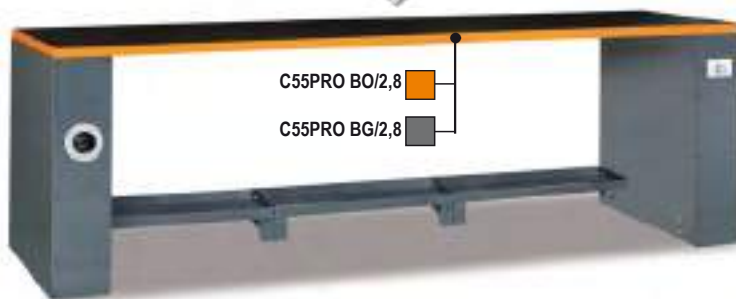

C55PRO BO/2,8	€ 3.500,00	1	055000271
C55PRO BG/2,8	€ 3.500,00	1	055000283

C55B-D4

Bancada de trabalho dupla, com apoio central, 4m

Bancada de 4100x700mm revestida a PVC, resistente a choques, cortes e hidrocarbonetos. • Furos para torno 1599F/150 - 1599GI/150 (pedido à parte) • Pés com regulação de altura • Apoio central com compartimento e porta de correr de 350x700mm

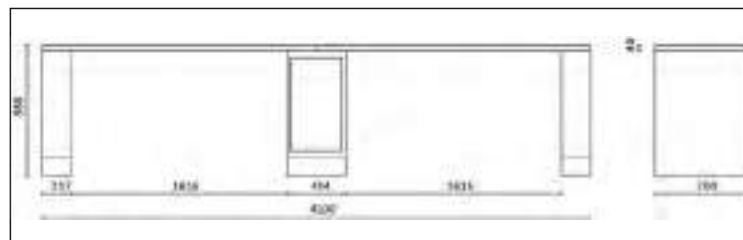
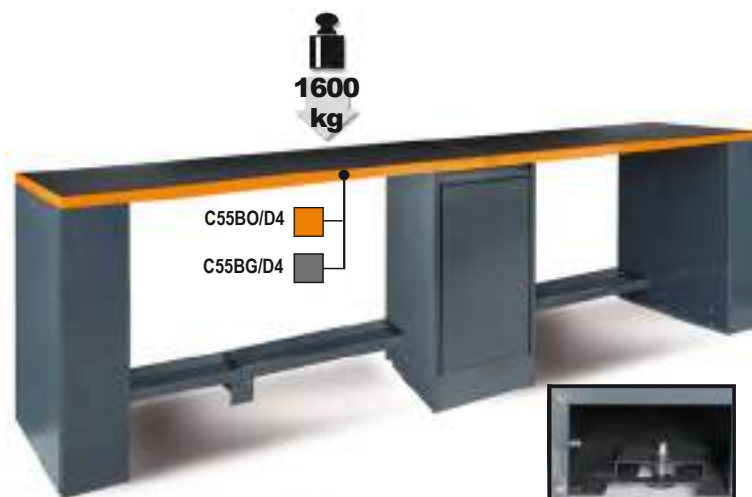

185 kg

C55BO/D4	€ 4.800,00	1	055000109
C55BG/D4	€ 4.800,00	1	055000119

C55PRO B-D4

bancada de trabalho dupla, com apoio central, 4m

Bancada de trabalho (4100x700mm) com tampo revestido a PVC anti-riscos e anti-impacto, resistente a hidrocarbonetos

Tomada e enrolador incluído:

- Tomada Schuko +16 +10A
- Tomada EU +10A
- Saída de ar comprimido com enrolador Ø 8 mm, comp.: 10 m
- Furos para fixação de torno (1599F/150 - 1599GI/150, opcional)
- Pés com regulação de altura
- Apoio central com compartimento para ferramentas e porta 365x750mm

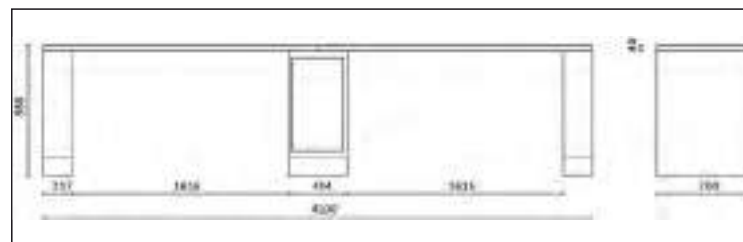
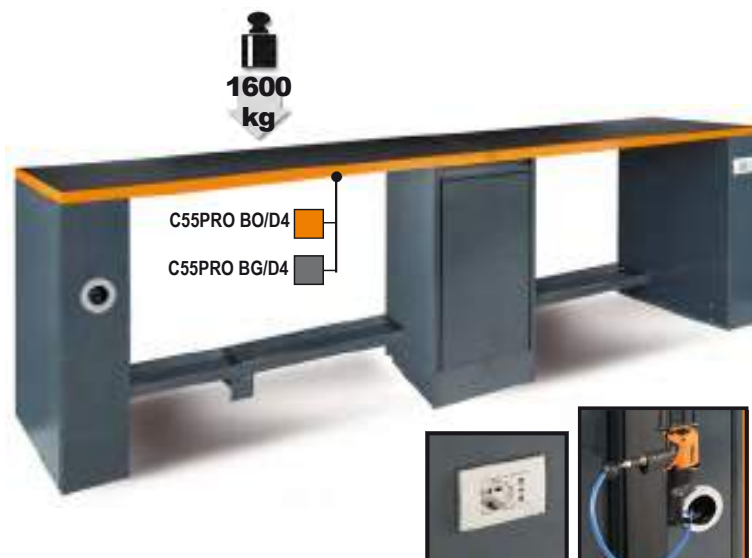

190 kg

C55PRO-BO/D4	€ 5.350,00	1	055000159
C55PRO-BG/D4	€ 5.350,00	1	055000179

 **Beta**

C55B/G

Apoio universal para bancada de oficina

- Com ajuste vertical
- Pode ser utilizado em ambos os lados da bancada de trabalho
- Abertura frontal e lateral

30 kg

C55B/G € 635,00 1 055000096

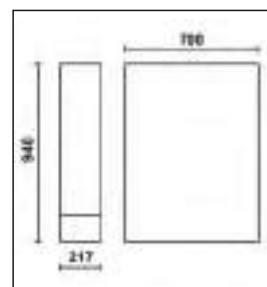

C55B/GAA

apoio universal com enrolador de tubo para bancada de trabalho

- Enrolador de tubo automático para ar comprimido ou água fria, Ø 8 mm
- Comprimento do tubo: 10 m
- Pés com regulação vertical
- Abertura frontal e lateral

35 kg

C55B/GAA € 1.030,00 1 055000099

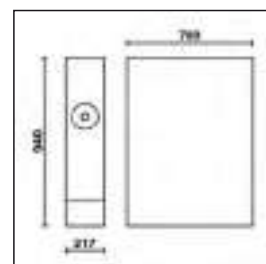

C55B/GDP

pilar duplo para bancadas de trabalho

- Compartimento para rolo de papel
- Compartimento com porta
- Pés com regulação vertical

45 kg

C55B/GDP € 1.510,00 1 055000292

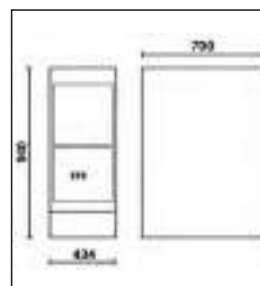

C55B/GDS

perna dupla para bancada de trabalho adjacente

- Compartimento com porta deslizante, 365x750 mm
- Pés com regulação ajustável

45 kg

C55B/GDS € 1.350,00 1 055000291

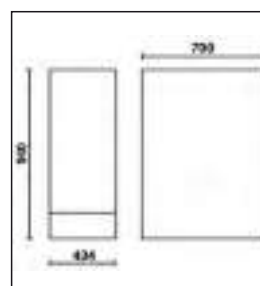

C55B/GE

Apoio universal com tomadas para bancada de oficina

- Tomada Shuko+16+10A
- Ficha EU + 10A
- Com ajuste vertical
- Abertura frontal e lateral

30 kg

C55B/GE

€ 780,00 1 055000097

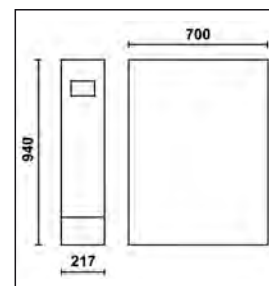

C55B/GAE

apoio universal com enrolador de cabo elétrico para bancada de trabalho

- Enrolador de cabo elétrico automático com tomada Schuko.
- Comprimento do cabo: 15 m
- Interruptor de proteção térmica
- Pés com ajuste vertical
- Abertura frontal e lateral

35 kg

C55B/GAE

€ 1.100,00 1 055000094

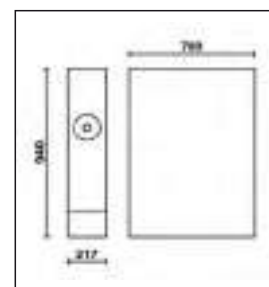

C55/PL-1,024

plano de trabalho com 1m de comprimento

Plano de trabalho em chapa pintada (1024x700 mm) com revestimento em PVC anti-riscos e anti-impacto, resistente a hidrocarbonetos

21 kg

C55/PLO-1,024	€ 525,00	1	055000130
C55/PLG-1,024	€ 525,00	1	055000131



C55B PT/2

bancada com 2 m de comprimento, para combinar com mobiliário de oficina

Bancada em chapa metálica pintada (2050x700 mm) com tampo revestido a PVC anti-riscos e anti-impacto, resistente a hidrocarbonetos
Furos para fixação do torno (1599F/150 - 1599GI/150, opcional)

43 kg

C55BO PT/2	€ 1.090,00	1	055000106
C55BG PT/2	€ 1.090,00	1	055000116

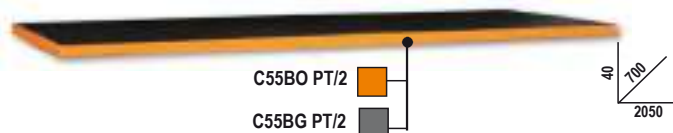

C55B PT/2,8

bancada com 2,8 m de comprimento, para combinar com mobiliário de oficina

Bancada em chapa metálica pintada (2850x700 mm) com tampo revestido a PVC anti-riscos e anti-impacto, resistente a hidrocarbonetos
Furos para fixação do torno (1599F/150 - 1599GI/150, opcional)

61 kg

C55BO PT/2,8	€ 1.700,00	1	055000266
C55BG PT/2,8	€ 1.700,00	1	055000286



C55RB

Revestimento em PVC resistente ao impacto e a hidrocarbonetos

Proteção de bancada de trabalho.

C55RB/2: para bancadas com 2 m de comprimento

C55RB/2.8: para bancadas com 2.8 m de comprimento

C55RB/0.7: para bancadas 700x700mm

C55RB/1: para bancadas com 1 m de comprimento

C55RB/2	€ 185,00	1	055000195
C55RB/2,8	€ 250,00	1	055000196
C55RB/0,7	€ 103,00	1	055000199
C55RB/1	€ 140,00	1	055000198



C55B/VS

Suporte inferior para bancada de trabalho, com 0,8m de comprimento

Dimensões: 800x230x60 mm

4 kg

C55B/VS	€ 140,00	1	055000095
---------	----------	---	-----------



C55C7

carro com 7 gavetas, para combinar com mobiliário de oficina

7 gavetas (588x367 mm) com calhas assentes em rolamentos de esferas

- 4 rodízios Ø 100 mm, 2 fixos (um com travão) and 2 giratórios
- Sistema de abertura em alumínio a toda a extensão da gaveta
- Gavetas protegidas com tapetes em borracha
- Fecho frontal centralizado
- Adaptável a encaixes maleáveis

79 kg

1000 kg

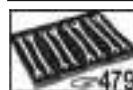

h	max
70 mm	30 kg
245 mm	40 kg

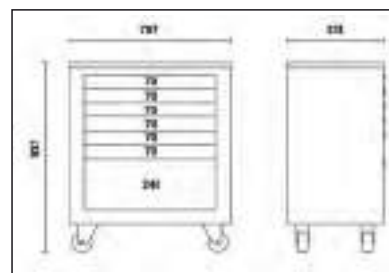

C55C7

€ 2.190,00 1 055000201

 **Beta**

C55C8

carro com 8 gavetas, para combinar com mobiliário de oficina

8 gavetas (588x367 mm) com calhas assentes em rolamentos de esferas

- 4 rodízios Ø 100 mm, 2 fixos (um com travão) e 2 rotativos
- Sistema de abertura em alumínio a toda a extensão da gaveta
- Gavetas protegidas por tapetes em borracha
- Fecho frontal centralizado
- Adaptável a encaixes maleáveis

81 kg

1000 kg



h	max
70 mm	30 kg
175 mm	40 kg

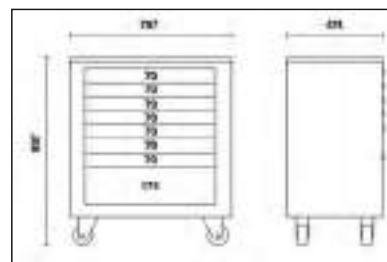

C55C8

€ 2.220,00 1 055000206

C55M2

módulo fixo com 2 gavetas, para combinar com mobiliário de oficina

2 gavetas (588x367mm) com calhas assentes em rolamentos de esferas

- Sistema de abertura em alumínio a toda a extensão da gaveta
- Gavetas protegidas por tapetes em borracha
- Fecho frontal centralizado

66 kg



h	max
280 mm	40 kg
385 mm	40 kg

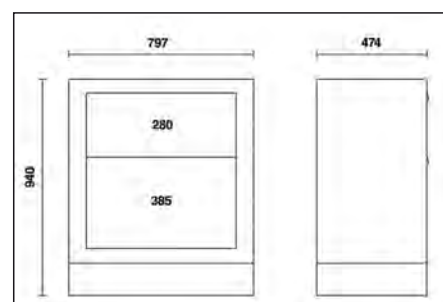

C55M2

€ 1.860,00 1 055000202

C55M4

Módulo fixo com 4 gavetas para combinar com mobiliário de oficina

4 gavetas (588x367) com calhas assentes em rolamentos de esferas

- Sistema de abertura em alumínio a toda a extensão da gaveta
- Base das gavetas protegida com tapetes em borracha
- Fecho frontal centralizado

75 kg



h	max
140 mm	30 kg
245 mm	40 kg

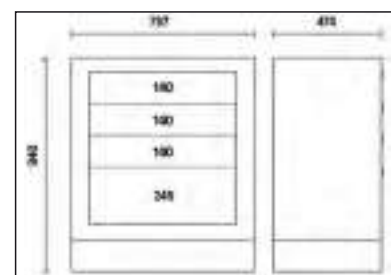

C55M4

€ 1.950,00 1 055000212

C55M7

módulo fixo com 7 gavetas, para combinar com mobiliário de oficina

7 gavetas (588x367 mm) com calhas assentes em rolamentos de esferas

- Sistema de abertura em alumínio a toda a extensão da gaveta
- Gavetas protegidas com tapetes em borracha
- Fecho frontal centralizado
- Adaptável a encaixes maleáveis

78 kg



h	max
70 mm	30 kg
245 mm	40 kg

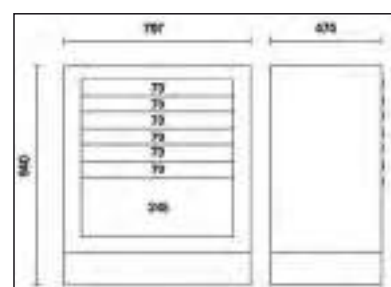

C55M7

€ 2.070,00 1 055000203

C55M8

Módulo fixo com 8 gavetas para equipamento de oficina

8 gavetas (588x367 mm) com calhas assentes em rolamentos de esferas

- Sistema de abertura em alumínio a toda a extensão da gaveta
- Gavetas protegidas com tapetes em borracha
- Fecho frontal centralizado
- Adaptável a tabuleiros maleáveis

📦 78,9 kg



h	max
70 mm	30 kg
175 mm	40 kg

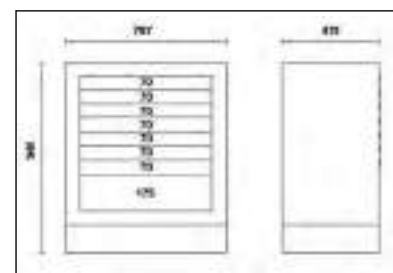

C55M8

€ 2.110,00 1 055000207

C55CS

Módulo para resíduos diferenciados, para equipamento de oficina

- Compartimento de resíduos deslizante (588x465mm)
- 2 recipientes internos de separação de resíduos

📦 62 kg

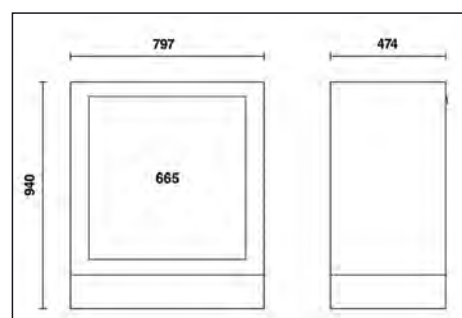

C55 CS

€ 1.880,00 1 055000208

C55MA

módulo fixo de duas portas, para combinar com mobiliário de oficina

- Abertura push-pull
- Com fechadura • Prateleira interior, com regulação vertical

75 kg

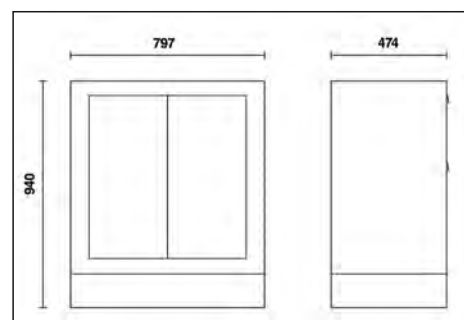

C55MA

€ 1.610,00 1 055000205

C55MDO

Módulo fixo de distribuição de óleo para móveis de oficina

- 2 bobinas com mangueira de 7m - 1/2" incluída
- Contém 2 pistolas com contador de litro digital e coletor automático.
- Caudal máx: 30 l / min
- Viscosidade: 8 ÷ 2000 mPas

94 kg

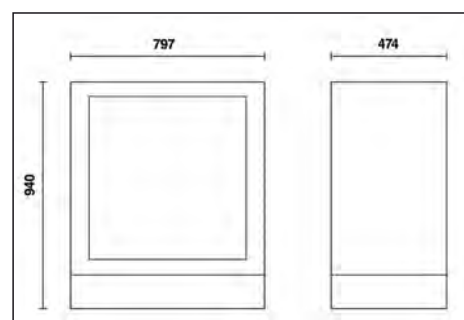

C55MDO

€ 3.360,00 1 055000210

C55MS

módulo fixo, para combinar com mobiliário de oficina

- Caixa do lixo integrado
- Compartimento para rolo de papel perfurado
- Gaveta de arrumação, 305x270 mm

📦 75 kg

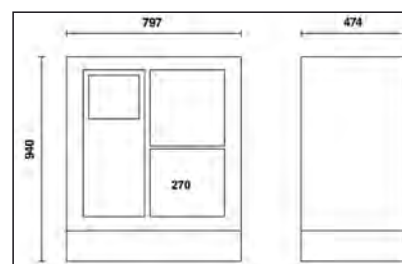

C55MS

€ 1.700,00 1 055000204

C55T3

Carro

- 3 planos com revestimento antiderrapante em borracha rugosa
- Punho ergonómico
- 2 opções de fixação de posto de trabalho central
- 4 rodízios Ø 100 mm (2 com travões)
- Capacidade estática de carga: 200 kg (distribuída pelas 3 prateleiras)

📦 21 kg

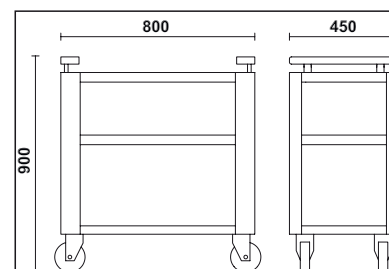

C55T3

€ 384,00 1 055000219

C55P/MCD

Suportes centrais duplos

10 kg

C55P/MCD € 162,00 1 055000257



C55P/2MDX-SX

Par de suportes verticais, direito/esquerdo

10 kg

C55P/2MDX-SX € 294,00 1 055000253



C55PM

Armário suspenso com 1m de comprimento

• Dimensões: 1024x400x300 mm; com amortecedores a gás, para fácil utilização das portas.

24 kg

C55PM € 1.080,00 1 055000302



C55PFA-1,0

Painel de ferramentas perfurado, com 1 m de comprimento, para combinar com mobiliário de oficina

Painel de ferramentas em aço perfurado (1024x1020x25 mm)

11 kg

C55PFA-1,0 € 362,00 1 055000316

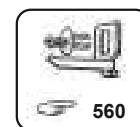

C55/PF

Painel de ferramentas com armário, para combinar com mobiliário de oficina, com 1m de comprimento

• Painel de ferramentas (1024x600mm) compatível com C55PT 1,0 x 0,6

6 kg

C55/PF € 248,00 1 055000307



C55PT1,0X0,6

Painel inferior do armário, com 1 m de comprimento

Dimensões: 1024x620x25 mm

8 kg

C55PT1,0X0,6

€ 198,00 1 055000314



C55PTE-1,0

Painel inferior do armário, com 1 m de comprimento

Dimensões: 1024x620x25 mm

Prevê incorporação de 2 tomadas (não incluídas)

8 kg

C55PTE-1,0

€ 236,00 1 055000319



C55/2PM

painel de ferramentas com 2 armários suspensos, para combinar com mobiliário de oficina

- 2 armários suspensos, 1024x400x300 mm, com molas pneumáticas, para fácil utilização das portas.
- Painel de ferramentas para parede, 2050x620 mm; adaptável aos painéis de ferramentas perfurados C55/PF (a encomendar separadamente)
- Fornecido com a estrutura
- Corresponde a bancada de trabalho de 2 m de comprimento

80 kg

C55/2PM

€ 3.010,00 1 055000301

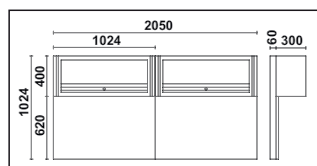

Beta

C55PFA-0,8

Painel de ferramentas perfurado, com 0,8 m de comprimento, para combinar com mobiliário de oficina

Painel de ferramentas em aço perfurado (800x1020x25 mm)

10 kg

C55PFA-0,8

€ 332,00 1 055000315



C55PM/M0,8

Armário suspenso com 0,8m de comprimento, para combinar com mobiliário de oficina

Dimensões: 800x400x300 mm; com molas pneumáticas para facilitar a abertura das portas.

19 kg

C55PM/M0,8

€ 1.040,00 1 055000312



C55PTE-0,8

Painel inferior do armário, com 0,8 m de comprimento

Dimensões: 800x620x25 mm

Prevê incorporação de 1 Tomada (não incluída)

6 kg

C55PTE-0,8

€ 213,00 1 055000318



C55PT0,8X0,6

Painel inferior do armário, com 0,8 m de comprimento

Dimensões: 800x620x25 mm

7,8 kg

C55PT0,8X0,6

€ 185,00 1 055000313



C55/1PF

painel perfurado para ferramentas, a combinar com mobiliário de oficina

• Painel perfurado para ferramentas (800x600 mm)

5 kg

C55/1PF

€ 166,00 1 055000309



C55PS

painel para ferramentas com persiana, para combinar com mobiliário de oficina

- Persiana em alumínio, com regulação vertical e fechadura
- Painel de ferramentas perfurado e amovível
- Fornecido com estrutura
- Kit de 50 ganchos GPS incluídos
- Corresponde a bancada de trabalho de 2 m de comprimento

88 kg

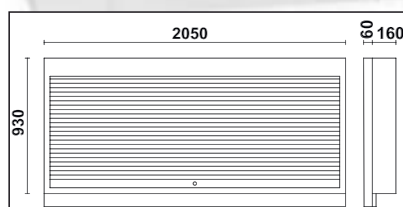

C55PS-O	€ 2.130,00	1	055000250
C55PS-G	€ 2.130,00	1	055000255

C55PSE

Painel para ferramentas com persiana, com 2 tomadas

- Persiana em alumínio, com regulação vertical e fechadura
- Painel de ferramentas perfurado e amovível
- Fornecido com estrutura
- Kit de 50 ganchos GPS incluídos
- Tomadas incluídas
- Bancada de trabalho com 2m de comprimento

88 kg

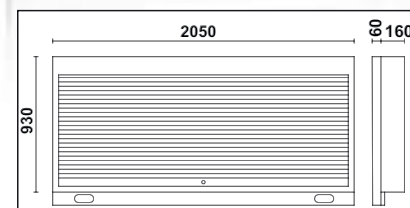

C55PSE-O	€ 2.160,00	1	055000258
C55PSE-G	€ 2.160,00	1	055000260

C55AE

Perfil de apoio com tomadas, com 2 m de comprimento

Dimensões: 2050x25x90mm
2 Tomadas

1,5 kg



C55AE	€ 198,00	1	055000325
-------	----------	---	-----------

C55AC

ângulo de apoio

Bancada com pés de apoio (700x700)

2 sistemas de parede de ferramentas com 2 prateleiras de fixação (670x160mm)

66 kg

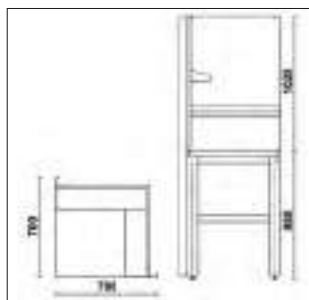

C55AC-O

C55AC-G



C55AC-O	€ 2.460,00	1	055000360
C55AC-G	€ 2.460,00	1	055000380

C55KAI

Canto para bancada 700x700, com apoio para combinar com mobiliário de oficina

• Tampo em chapa pintada (700x700mm) com revestimento em PVC resistente ao impacto e hidrocarbonetos

32 kg

C55KAI-O

C55KAI-G

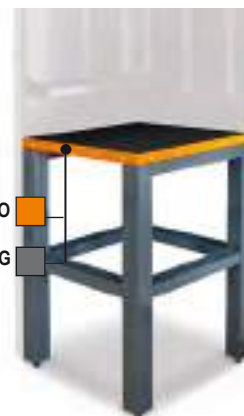

C55KAI-O	€ 1.420,00	1	055000365
C55KAI-G	€ 1.420,00	1	055000385

C55KAS

canto superior com painel de ferramentas

• 2 painéis de ferramentas (700x1020x25 mm)
• 2 prateleiras (670x160mm)

24 kg



C55KAS	€ 1.050,00	1	055000370
--------	------------	---	-----------

C55MP

prateleiras em aço para cantos

Dimensões: 700x160x80 mm



C55MP	€ 147,00	1	055000374
-------	----------	---	-----------

 **Beta**

C55B/1

Extensão para bancada de trabalho , 1 m de comprimento

Tampo para bancada de trabalho (1024x700 mm) com revestimento em PVC resistente a choques e hidrocarbonetos

• Apoio universal com pés de ajuste vertical

1 módulo fixo:

7 gavetas (588x367 mm) com calhas assentes em rolamentos de esferas



• Sistema de abertura em alumínio a toda a extensão da gaveta

• Base das gavetas protegida com tapetes em borracha

• Fecho frontal centralizado

127 kg



	 max
70 mm	30 kg
245 mm	40 kg

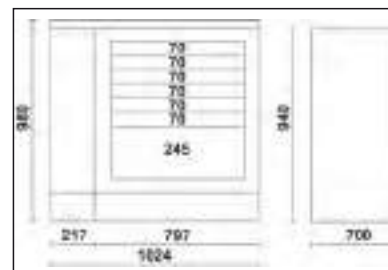
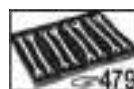

C55BO/1	€ 3.230,00	1	055000090
C55BG/1	€ 3.230,00	1	055000091



C55A1

armário para ferramentas em chapa metálica com uma porta, a combinar com mobiliário de oficina RSC55

- 3 prateleiras amovíveis com regulação vertical
- varão para vestuário sob a primeira prateleira
- com fechadura
- dimensões anteriores: 1770x420x420 mm

50 kg



C55A1

€ 780,00 1 055000411

C55A1/R42

prateleira interior para armário de ferramentas C55A1/C55AT1

2,4 kg



C55A1/R42

497x403 mm

€ 34,00 1 055000461

C55 A1/RB42

prateleira interior para armário C55A1/C55AT1, com varão para vestuário

2,5 kg



C55 A1/RB42

497x403 mm

€ 45,00 1 055000463

 **Beta**

C55A2

armário para ferramentas em chapa metálica com duas portas, a combinar com mobiliário de oficina

- 3 prateleiras amovíveis com regulação vertical
- Com fechadura
- Dimensões interiores (úteis): 1798x797x403 mm

📦 72 kg



C55A2

€ 1.050,00 1 055000412

C55A2/R70

prateleira interior para armário de ferramentas C55A2/C55AT2

📦 3,5 kg



C55A2/R70

700x420 mm

€ 55,00 1 055000462



C55AT1

armário para ferramentas em chapa metálica com duas portas em policarbonato transparente, para combinar com mobiliário modular de oficina

- 3 prateleiras amovíveis e de altura ajustável
- Com fechadura
- Dimensões espaço útil interior: 1798x497x403 mm

41 kg



C55AT1 € 935,00 1 055000421

C55AT2

armário para ferramentas em chapa metálica com duas portas em policarbonato transparente, para combinar com mobiliário modular de oficina

- 3 prateleiras amovíveis e de altura ajustável
- Com fechadura
- Dimensões espaço útil interior: 1798x797x403 mm

56 kg



C55AT2 € 1.260,00 1 055000422

C55STR

fita adesiva 25 m

permite adaptar as fitas verticais do mobiliário de garagem ref. C55



RAL2011
RAL3000
RAL6029
RAL9016
RAL1023
RAL5015
RAL1035
RAL9006

		€	1	055000901
C55STR-O/2011	Orange	79,50	1	055000901
C55STR-R/3000	Red	79,50	1	055000903
C55STR-V/6029	Green	79,50	1	055000906
C55STR-W/9016	White	79,50	1	055000907
C55STR-Y/1023	Yellow	79,50	1	055000905
C55STR-B/5015	Blue	79,50	1	055000904
C55STR-GO/1035	Grey	79,50	1	055000909
C55STR-S/9006	Black	79,50	1	055000902





MOBILIÁRIO PARA OFICINA

Beta
RSC50

Na Beta continuamos a investir na produção italiana e temos o orgulho de apresentar a

NOVA LINHA DE
EQUIPAMENTOS PARA OFICINA

Com base na experiência adquirida com as duas gamas de equipamentos de oficina existentes, RSC55 e C45PRO, que nos permitiram ouvir e compreender plenamente as necessidades dos utilizadores profissionais, o projeto da nova gama RSC50 assenta nos seguintes conceitos fundamentais:

Qualidade

O nosso cuidado na escolha dos materiais, atenção meticulosa aos detalhes e o design atraente fazem do RSC50 uma linha única de mobiliário de oficina.

Flexibilidade

Instalação simples e rápida, graças à otimização das várias peças da gama.



Compatibilidade

As gavetas nas dimensões standard da Beta (588x367 mm) podem acomodar os vários módulos de ferramentas, disponíveis nas versões maleável e rígida, em EVA e ABS, respetivamente.

Eficiência

Instalação simples e rápida, graças à otimização das várias peças da gama.



Funcionalidade e resistência

O plano de trabalho com 63 cm de profundidade resultam numa superfície prática e funcional, de grandes dimensões.

Pode ser equipado com um torno, permitindo assim a realização de trabalhos pesados.



MADE IN ITALY



Configure a sua oficina em 3D online em
www.beta-tools.com

A nova gama de equipamentos de oficina, RSC50, inclui combinações pré-montadas, desenvolvidas pela Beta para profissionais; em alternativa, pode projetar o seu próprio local de trabalho, escolhendo de entre muitos módulos, armários de parede e acessórios.

As cores personalizadas dos puxadores das gavetas e das luzes sob os planos de trabalho e armários de parede resultam em equipamentos de oficina únicos, tornando o RSC50 a escolha ideal para quem valoriza trabalhar num ambiente funcional e eficiente.



RSC50 I

estante para oficina RSC50

Inclui:

- 1 bancada de trabalho 2240 mm comp. (RSC50 PG/3-2.2MT)
- 1 bancada de trabalho 1495 mm comp. (RSC50 PG/2-1.5MT)
- 1 módulo fixo com 7 gavetas (RSC50 M7)
- 1 carro com 7 gavetas (RSC50 C7)
- 1 módulo de serviço fixo com 2 gavetas (RSC50 MS-2C)
- 1 canto completo (RSC50 AC-G)
- 1 módulo fixo com 5 gavetas (RSC50 M5)
- 1 módulo fixo com 2 portas (RSC50 MA)
- 5 armários suspensos (RSC50 PM)
- 5 painéis superiores perfurados para ferramentas (RSC50 PFS)
- 5 painéis inferiores perfurados para ferramentas (RSC50 PFI)
- 5 pares de suportes verticais, direito/esquerdo, com encaixe rápido (RSC50 P/2MDX-SX)
- 2 armários de 1 porta (RSC50 A1)

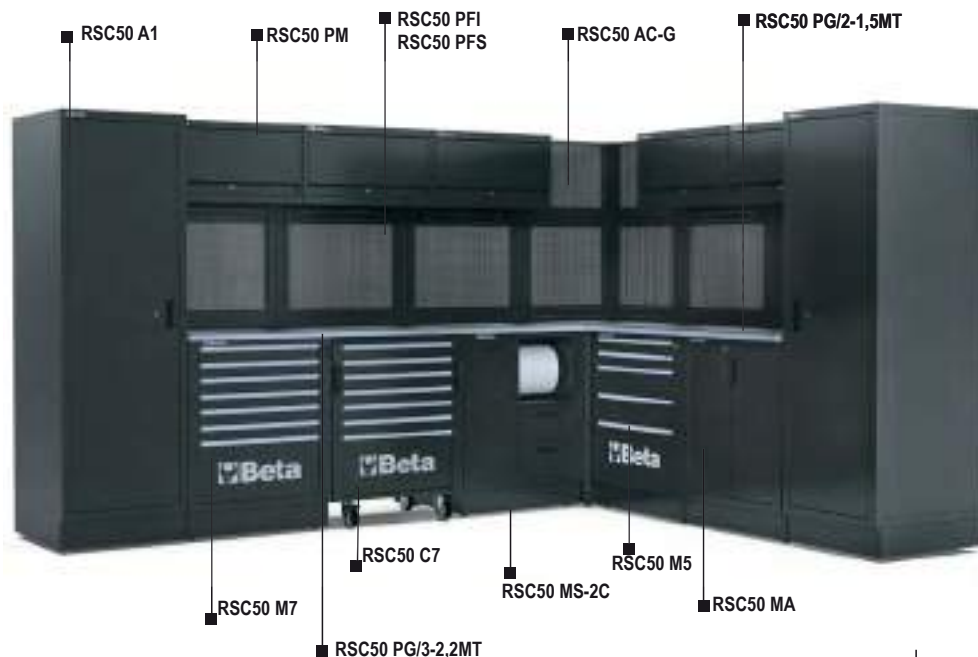

2000
690
3530 / 2785

625 kg

RSC50 I € 19.800,00 1 050001045

RSC50 L

estante para oficina RSC50

Inclui:

- 1 bancada de trabalho 2240 mm comp. (RSC50 PG/3-2.2MT)
- 1 bancada de trabalho 750 mm comp. (RSC50 PG/1-0.7MT)
- 1 módulo de serviço fixo (RSC50 MS-2AVV) com enrolador para tubo de ar comprimido artigo 1900S 8x10 e enrolador de cabo elétrico artigo 1844 15-H05/SCK (incluído)
- 1 carro com 7 gavetas (RSC50 C7)
- 1 módulo fixo com 7 gavetas (RSC50 M7)
- 1 canto completo (RSC50 AC-G)
- 1 módulo fixo com 2 portas (RSC50 MA)
- 1 painel para ferramentas com persiana em alumínio e estrutura (RSC50 PS)
- 2 armários suspensos (RSC50 PM)
- 2 painéis superiores perfurados para ferramentas (RSC50 PFS)
- 2 painéis inferiores perfurados para ferramentas (RSC50 PFI)
- 2 pares de suportes verticais, direito/esquerdo, com encaixe rápido (RSC50 P/2MDX-SX)
- 2 armários de 1 porta (RSC50 A1)

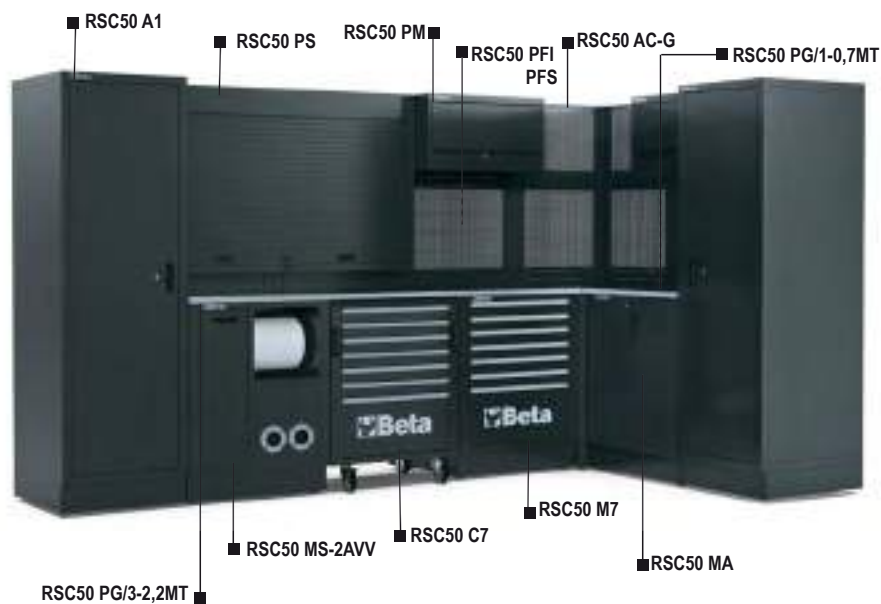

2000
690
3530 / 2040

541 kg

RSC50 L € 17.300,00 1 050001050

RSC50

estante completa para oficina RSC50

Inclui:

- 1 armário de 1 porta (RSC50 A1)
- 1 bancada de trabalho 750 mm comp. (RSC50 PG/1-0,7MT)
- 1 bancada de trabalho 2240 mm comp. (RSC50 PG/3-2,2MT)
- 1 carro de ferramentas com 7 gavetas (RSC50 C7)
- 1 módulo fixo com 4 gavetas (RSC50 M4)
- 1 módulo fixo com 7 gavetas (RSC50 M7)
- 1 módulo de serviço fixo (RSC50 MS-AVV) com enrolador para tubo de ar comprimido artigo 1900S 8x10 (incluído)
- 1 painel para ferramentas com persiana e estrutura (RSC50 PS)
- 2 armários suspensos (RSC50 PM)
- 2 painéis superiores perfurados para ferramentas (RSC50 PFS)
- 2 painéis inferiores perfurados para ferramentas (RSC50 PFI)
- 2 pares de suportes verticais, direito/esquerdo, com encaixe rápido (RSC50 P/2MDX-SX)
- 1 armário de 2 portas (RSC50 A2)



534 kg

RSC50 € 15.700,00 1 050001000

RSC50 H

estante para oficina RSC50

Inclui:

- 1 bancada de trabalho 2240 mm comp. (RSC50 PG/3-2,2MT)
- 1 módulo de serviço fixo com 2 gavetas (RSC50 MS-2C)
- 1 carro com 7 gavetas (RSC50 C7)
- 1 módulo fixo com 7 gavetas (RSC50 M7)
- 1 módulo fixo com lavatório (RSC50 ML)
- 4 armários suspensos (RSC50 PM)
- 4 painéis superiores perfurados para ferramentas (RSC50 PFS)
- 4 painéis inferiores perfurados para ferramentas (RSC50 PFI)
- 4 pares de suportes verticais, direito/esquerdo, com encaixe rápido (RSC50 P/2MDX-SX)
- 1 armário de 1 porta (RSC50 A1)



417 kg

RSC50 H € 13.700,00 1 050001040

RSC50 G

estante para oficina RSC50

Inclui:

- 1 bancada de trabalho 2240 mm comp. (RSC50 PG/3-2,2MT)
- 1 módulo de serviço fixo (RSC50 MS-2AVV) com enrolador para tubo de ar comprimido artigo 1900S 8x10 e enrolador de cabo elétrico artigo 1844 15-H05/SCK (incluído)
- 1 carro com 7 gavetas (RSC50 C7)
- 1 módulo fixo com 4 gavetas (RSC50 M4)
- 3 armários suspensos (RSC50 PM)
- 3 painéis superiores perfurados para ferramentas (RSC50 PFS)
- 3 painéis inferiores perfurados para ferramentas (RSC50 PFI)
- 3 pares de suportes verticais, direito/esquerdo, com encaixe rápido (RSC50 P/2MDX-SX)
- 1 armário de 2 portas (RSC50 A2)



356 kg

RSC50 G € 11.600,00 1 050001035

RSC50 F

estante para oficina RSC50

Inclui:

- 1 bancada de trabalho 2240 mm comp. (RSC50 PG/3-2,2MT)
- 1 módulo fixo com 7 gavetas (RSC50 M7)
- 1 carro com 7 gavetas (RSC50 C7)
- 1 módulo de serviço fixo com 2 gavetas (RSC50 MS-2C)
- 3 armários suspensos (RSC50 PM)
- 3 painéis superiores perfurados para ferramentas (RSC50 PFS)
- 3 painéis inferiores perfurados para ferramentas (RSC50 PFI)
- 3 pares de suportes verticais, direito/esquerdo, com encaixe rápido (RSC50 P/2MDX-SX)
- 1 armário de 2 portas (RSC50 A2)

361 kg

RSC50 F

€ 11.300,00 1 050001030



RSC50 E

estante para oficina RSC50

Inclui:

- 1 bancada de trabalho 2240 mm comp. (RSC50 PG/3-2,2MT)
- 1 módulo de serviço fixo com 2 gavetas (RSC50 MS-2C)
- 1 módulo fixo com 7 gavetas (RSC50 M7)
- 1 módulo fixo com 2 portas (RSC50 MA)
- 3 armários suspensos (RSC50 PM)
- 3 painéis superiores perfurados para ferramentas (RSC50 PFS)
- 3 painéis inferiores perfurados para ferramentas (RSC50 PFI)
- 3 pares de suportes verticais, direito/esquerdo, com encaixe rápido (RSC50 P/2MDX-SX)

266 kg

RSC50 E

€ 9.250,00 1 050001025



RSC50 D

estante para oficina RSC50

Inclui:

- 1 bancada de trabalho 1495 mm comp. (RSC50 PG/2-1,5MT)
- 1 módulo fixo com 5 gavetas (RSC50 M5)
- 1 módulo fixo com 2 portas (RSC50 MA)
- 2 armários suspensos (RSC50 PM)
- 2 painéis superiores perfurados para ferramentas (RSC50 PFS)
- 2 painéis inferiores perfurados para ferramentas (RSC50 PFI)
- 2 pares de suportes verticais, direito/esquerdo, com encaixe rápido (RSC50 P/2MDX-SX)
- 1 armário de 1 porta (RSC50 A1)

230 kg

RSC50 D

€ 7.100,00 1 050001020

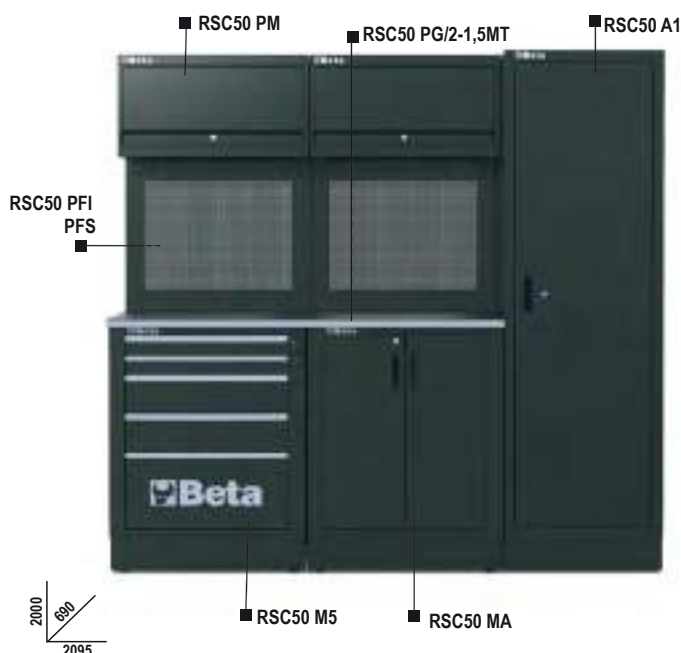

RSC50 C

estante para oficina RSC50

Inclui:

- 1 bancada de trabalho 1495 mm comp. (RSC50 PG/2-1,5MT)
- 1 módulo de serviço fixo com 2 gavetas (RSC50 MS-2C)
- 1 módulo fixo com 7 gavetas (RSC50 M7)
- 2 armários suspensos (RSC50 PM)
- 2 painéis superiores perfurados para ferramentas (RSC50 PFS)
- 2 painéis inferiores perfurados para ferramentas (RSC50 PFI)
- 2 pares de suportes verticais, direito/esquerdo, com encaixe rápido (RSC50 P/2MDX-SX)
- 1 armário de 1 porta (RSC50 A1)

258 kg

RSC50 C

€ 7.500,00 1 050001015

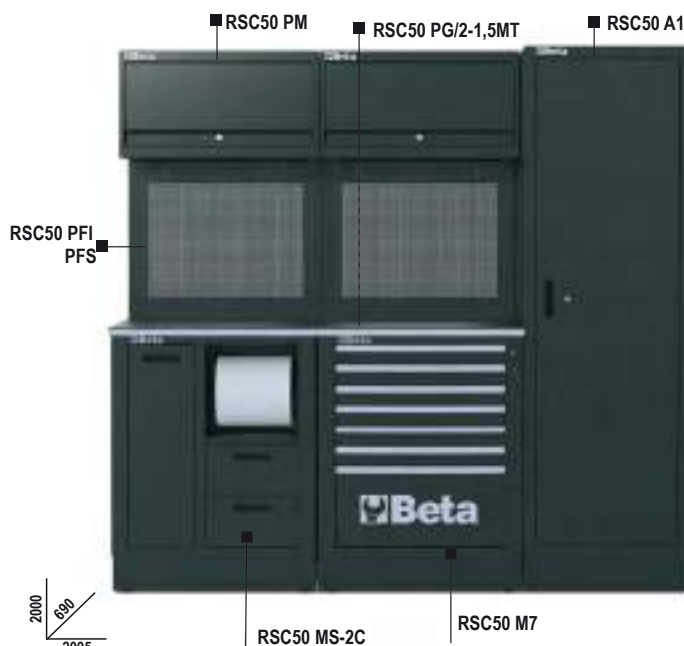

RSC50 B

estante para oficina RSC50

Inclui:

- 1 bancada de trabalho 1495 mm comp. (RSC50 PG/2-1,5MT)
- 1 módulo fixo com 2 portas (RSC50 MA)
- 1 módulo fixo com 7 gavetas (RSC50 M7)
- 1 painel para ferramentas com persiana em alumínio e estrutura (RSC50 PS)

188 kg

RSC50 B

€ 6.450,00 1 050001010



RSC50 A

estante para oficina RSC50

Inclui:

- 1 bancada de trabalho 1495 mm comp. (RSC50 PG/2-1,5MT)
- 1 módulo fixo com 7 gavetas (RSC50 M7)
- 1 módulo de serviço fixo com 2 gavetas (RSC50 MS-2C)
- 2 armários suspensos (RSC50 PM)
- 2 painéis superiores perfurados para ferramentas (RSC50 PFS)
- 2 painéis inferiores perfurados para ferramentas (RSC50 PFI)
- 2 pares de suportes verticais, direito/esquerdo, com encaixe rápido (RSC50 P/2MDX-SX)

192 kg

RSC50 A

€ 6.550,00 1 050001005

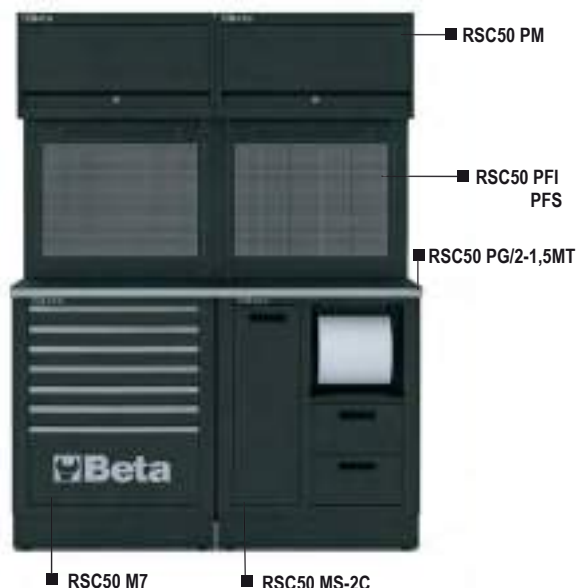

RSC50 P/1-0,7MT

bancada de trabalho 0.75 m comp., para combinar com mobiliário de oficina RSC50

Bancada em chapa metálica pintada, 750x630 mm, com tampo revestido a PVC anti-riscos e anti-impacto, resistente a hidrocarbonetos. Com dois amortecedores laterais e dois encaixes rápidos.

Furos para fixação do torno (1599P/125, opcional).

12,4 kg

RSC50 PG/1-0,7MT	€ 535,00	1	050001107
RSC50 PA/1-0,7MT	€ 535,00	1	050001108

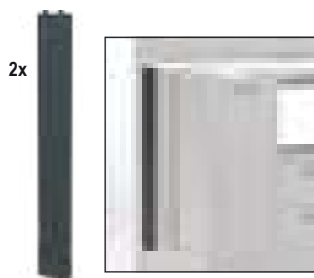

RSC50 P/2-1,5MT

bancada de trabalho 1.5 m comp., para combinar com mobiliário de oficina RSC50

Bancada em chapa metálica pintada, 1495x630mm, com tampo revestido a PVC anti-riscos e anti-impacto, resistente a hidrocarbonetos. Com dois amortecedores laterais e dois encaixes rápidos.

Furos para fixação do torno (1599P/125, opcional).

24,5 kg

RSC50 PG/2-1,4MT	€ 750,00	1	050001114
RSC50 PA/2-1,4MT	€ 750,00	1	050001115

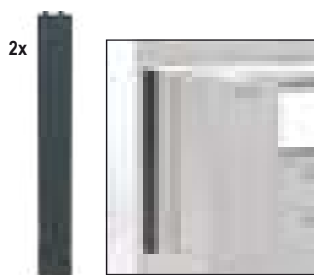

RSC50 P/3-2,2MT

bancada de trabalho 2.2 m comp., para combinar com mobiliário de oficina RSC50

Bancada em chapa metálica pintada, 2240x630mm, com tampo revestido a PVC anti-riscos e anti-impacto, resistente a hidrocarbonetos. Com dois amortecedores laterais e dois encaixes rápidos.

Furos para fixação do torno (1599P/125, opcional).

36,5 kg

RSC50 PG/3-2,2MT	€ 910,00	1	050001122
RSC50 PA/3-2,2MT	€ 910,00	1	050001123

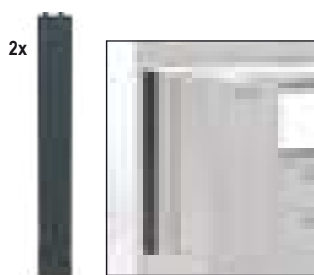
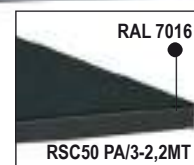

Beta

RSC50 RB

revestimento em PVC anti-choque, anti-riscos, resistente a hidrocarbonetos

Um essencial para proteger bancadas de trabalho.

RSC50 RB/0,63: para bancada de canto, 630x630 mm

RSC50 RB/0,75: para bancada 750mm comp.

RSC50 RB/1,5: para bancada 1.495mm comp.

RSC50 RB/2,2: para bancada 2.240mm comp.



	€		
RSC50 RB/0,63	58,00	1	050001140
RSC50 RB/0,75	69,50	1	050001141
RSC50 RB/1,5	139,00	1	050001142
RSC50 RB/2,2	208,00	1	050001143

RSC50 C5

carro com 5 gavetas, para combinar com mobiliário de oficina RSC50

- 5 gavetas (588x367 mm) com calhas assentes em rolamentos de esferas
- 4 rodízios, Ø 100 mm (dois com travão)
- Gavetas protegidas por tapetes em borracha
- Fecho frontal centralizado
- Punhos incorporados na estrutura para maior facilidade de manuseamento
- Cada gaveta pode acomodar até 4 tabuleiros de espuma EVA ou ABS

51,4 kg

h	max
70 mm	25 kg
140 mm	30 kg
280 mm	35 kg

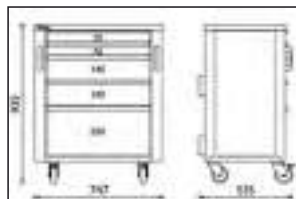

800 kg



RSC50 C5	1.910,00	1	050001205
----------	----------	---	-----------

RSC50 C7

carro com 7 gavetas, para combinar com mobiliário de oficina RSC50

- 7 gavetas (588x367 mm) com calhas assentes em rolamentos de esferas
- 4 rodízios, Ø 100 mm (dois com travão)
- Gavetas protegidas por tapetes em borracha
- Fecho frontal centralizado
- Punhos incorporados na estrutura para maior facilidade de manuseamento
- Cada gaveta pode acomodar até 4 tabuleiros de espuma EVA ou ABS

56,3 kg

h	max
70 mm	25 kg
280 mm	35 kg

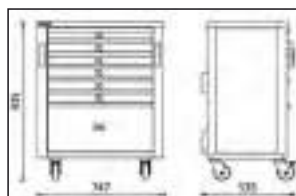

800 kg





RSC50 C7	1.990,00	1	050001207
----------	----------	---	-----------

RSC50 C8

carro com 8 gavetas, para combinar com mobiliário de oficina RSC50

- 8 gavetas (588x367 mm) com calhas assentes em rolamentos de esferas
- 4 rodízios, Ø 100 mm (dois com travão)
- Gavetas protegidas por tapetes em borracha
- Fecho frontal centralizado
- Punhos incorporados na estrutura para maior facilidade de manuseamento
- Cada gaveta pode acomodar até 4 tabuleiros de espuma EVA ou ABS

59 kg

	
70 mm	25 kg
140 mm	30 kg

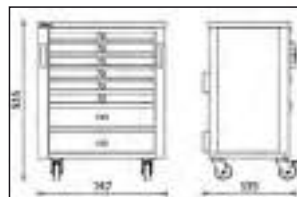

800 kg



RSC50 C8



€ 2.030,00 1 050001208

RSC50 M4

módulo fixo com 4 gavetas, para combinar com mobiliário de oficina RSC50

- 4 gavetas (588x367 mm) com calhas assentes em rolamentos de esferas
- Gavetas protegidas por tapetes em borracha
- Fecho frontal centralizado
- Com pés ajustáveis verticalmente
- Cada gaveta pode acomodar até 4 tabuleiros de espuma EVA ou ABS

44,5 kg

	
140 mm	30 kg
280 mm	35 kg

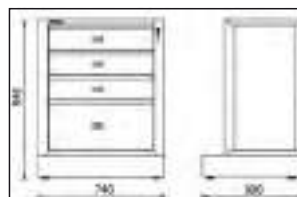

RSC50 M4



€ 1.620,00 1 050001224

RSC50 M5

módulo fixo com 5 gavetas, para combinar com mobiliário de oficina RSC50

- 5 gavetas (588x367 mm) com calhas assentes em rolamentos de esferas
- Gavetas protegidas por tapetes em borracha
- Fecho frontal centralizado
- Com pés ajustáveis verticalmente
- Cada gaveta pode acomodar até 4 tabuleiros de espuma EVA ou ABS

47 kg

	
70 mm	25 kg
140 mm	30 kg
280 mm	35 kg

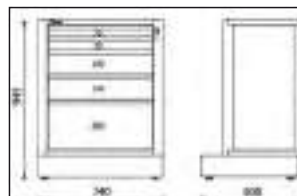



RSC50 M5

€ 1.660,00 1 050001225

RSC50 M7

módulo fixo com 7 gavetas, para combinar com mobiliário de oficina RSC50

- 7 gavetas (588x367 mm) com calhas assentes em rolamentos de esferas
- Gavetas protegidas por tapetes em borracha
- Fecho frontal centralizado
- Com pés ajustáveis verticalmente
- Cada gaveta pode acomodar até 4 tabuleiros de espuma EVA ou ABS

	
70 mm	25 kg
280 mm	35 kg

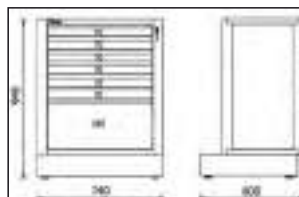

52 kg



RSC50 M7

€ 1.740,00 1 050001227

RSC50 M8

módulo fixo com 8 gavetas, para combinar com mobiliário de oficina RSC50

- 8 gavetas (588x367 mm) com calhas assentes em rolamentos de esferas
- Gavetas protegidas por tapetes em borracha
- Fecho frontal centralizado
- Com pés ajustáveis verticalmente
- Cada gaveta pode acomodar até 4 tabuleiros de espuma EVA ou ABS

	
70 mm	25 kg
140 mm	30 kg

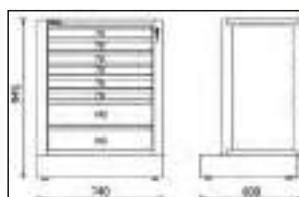

53,2 kg



RSC50 M8

€ 1.790,00 1 050001228

RSC50 M10

módulo fixo com 10 gavetas, para combinar com mobiliário de oficina RSC50

- 10 gavetas (588x367 mm) com calhas assentes em rolamentos de esferas
- Gavetas protegidas por tapetes em borracha
- Fecho frontal centralizado
- Com pés ajustáveis verticalmente
- Cada gaveta pode acomodar até 4 tabuleiros de espuma EVA ou ABS

	
70 mm	25 kg

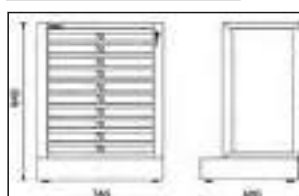

58,2 kg

RSC50 M10

€ 1.870,00 1 050001230

RSC50 MS-2C

módulo de serviço fixo, para combinar com mobiliário de oficina RSC50

- Caixote do lixo integrado
- Compartimento para rolo de papel
- Duas gavetas, 310x370 mm, 180 mm altura
- Com pés ajustáveis verticalmente

57 kg

RSC50 MS-2C € 1.640,00 1 050001243

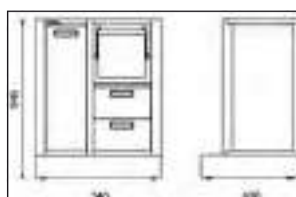

RSC50 MS-AVV

módulo de serviço fixo, para combinar com mobiliário de oficina RSC50, vazio

Permite utilizar dois enroladores, a escolher de entre os seguintes modelos:

- enroladores para ar comprimido artigo 1900S 8x10
- enroladores de cabo elétrico artigos 1843 15-H05, 1844 10-H05, 1844 15-H05, 1844 15-H07, 1844 15-H05/SCK, 1844 15-H07/SCK, 1845 12-H05, 1846 10-H05, 1846 10-H07 e 1846 15-H05

- Caixote do lixo integrado
- Compartimento para rolo de papel
- Com pés ajustáveis verticalmente

41,5 kg

RSC50 MS-AVV € 1.510,00 1 050001241

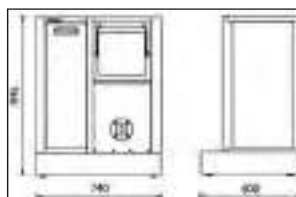

RSC50 MS-2AVV

módulo de serviço fixo, para combinar com mobiliário de oficina RSC50, vazio

- Caixote do lixo integrado
- Compartimento para rolo de papel
- Com pés ajustáveis verticalmente

Permite utilizar dois enroladores, a escolher de entre os seguintes modelos:

- enroladores para ar comprimido artigo 1900S 8x10
- enroladores de cabo elétrico artigos 1843 15-H05, 1844 10-H05, 1844 15-H05, 1844 15-H07, 1844 15-H05/SCK, 1844 15-H07/SCK, 1845 12-H05, 1846 10-H05, 1846 10-H07 e 1846 15-H05

41,7 kg

RSC50 MS-2AVV € 1.560,00 1 050001242

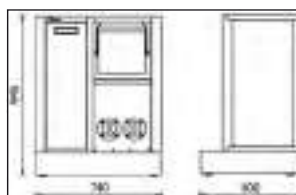

RSC50 MA

módulo fixo com 2 portas, para combinar com mobiliário de oficina RSC50

- Com fechadura
- Prateleira interior com regulação vertical
- Dimensões interiores: 615x435x740 mm
- Com pés ajustáveis verticalmente

34 kg

RSC50 MA

€ 1.350,00 1 050001222

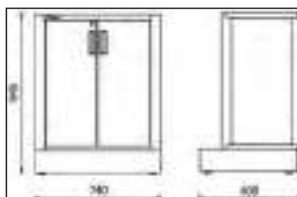

RSC50 CS

módulo para resíduos diferenciados, para combinar com mobiliário de oficina RSC50

- Compartimento de resíduos deslizante (588x355x580 mm) com calhas assentes em rolamentos de esferas
- 2 recipientes internos de separação de resíduos

36 kg

RSC50 CS

€ 1.560,00 1 050001245

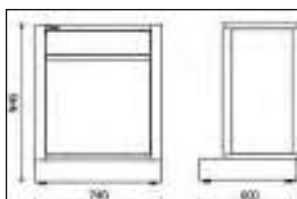

RSC50 ML

módulo fixo com lavatório, para combinar com mobiliário de oficina RSC50

Características técnicas:

- Lavatório em aço inox
- Fornecido com:
 - 1 torneira misturadora
 - 1 unidade de drenagem
 - 1 tampa do ralo
 - 1 tampa do filtro
 - 1 dispensador de sabão

Módulo fixo com 2 portas e fechadura:

- Dimensões interiores: 615x435x575 mm
- Com pés ajustáveis verticalmente

33,5 kg

RSC50 ML

€ 1.680,00 1 050001244

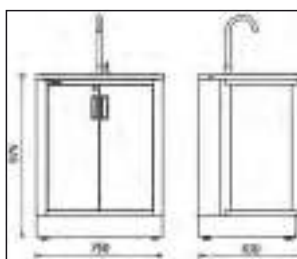

RSC50 MDO

módulo fixo de distribuição de óleo, para combinar com mobiliário de oficina RSC50

- 2 enroladores com 7m tubo 1/2" incluídos
- Equipado com 2 pistolas com contador de litros digital e coletor automático
- débito máx.: 30 l/min
- viscosidade: 8÷2000 mPas
- Com pés ajustáveis verticalmente

📦 74 kg

RSC50 MDO

€ 3.130,00 1 050001250

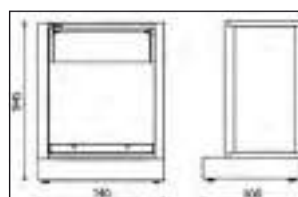

RSC50 T3

carro de ferramentas com três prateleiras, para combinar com mobiliário de oficina RSC50

- 4 rodízios, Ø 100 mm (dois com travão)
- Capacidade de carga estática: 200 kg (distribuídos pelas 3 prateleiras)

📦 22,3 kg

RSC50 T3

€ 368,00 1 050001253

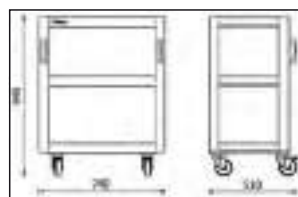

RSC50 KPF

kit de painéis perfurados para ferramentas, para combinar com mobiliário de oficina RSC50

- 1 painel de ferramentas perfurado superior, 650x400x25 mm
- 1 painel de ferramentas perfurado inferior, 650x625x25 mm, permite acomodar uma tomada múltipla de 19" (não incluído)
- Um par de suportes direito/esquerdo

14,8 kg



RSC50 KPF

€ 625,00 1 050001310

RSC50 PFS

painel superior perfurado para ferramentas, para combinar com mobiliário de oficina RSC51

- Painel perfurado para ferramentas, 650x400x25 mm

2,5 kg



RSC50 PFS

€ 178,00 1 050001312

RSC50 PFI

painel inferior perfurado para ferramentas, para combinar com mobiliário de oficina RSC50

- Painel inferior perfurado para ferramentas, 650x625x25 mm
- Permite utilizar uma tomada múltipla (não incluída)

3,8 kg



RSC50 PFI

€ 204,00 1 050001313

RSC50 P/2MDX-SX

par de suportes verticais, direito/esquerdo, com encaixe rápido

8,5 kg

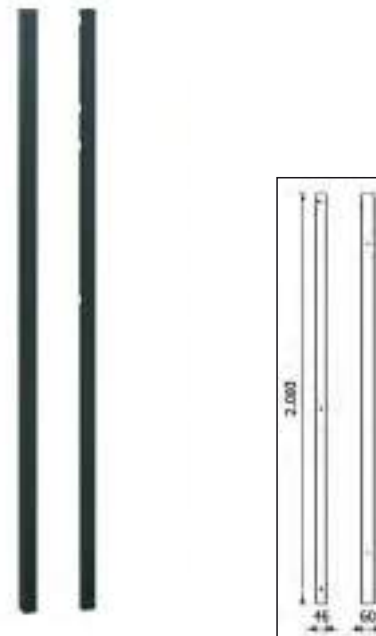

RSC50 P/2MDX-SX

€ 244,00 1 050001352

RSC50 PM

armário suspenso com 740 mm comp., para combinar com mobiliário de oficina RSC50

• Dimensões: 740x300x400 mm
com amortecedores a gás, para fácil utilização das portas

14 kg

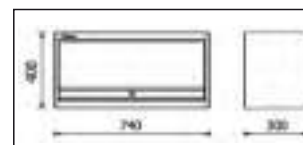

RSC50 PM

€ 580,00 1 050001302

RSC50 MTP

prateleira triangular, para combinar com mobiliário de oficina RSC50

• Dimensões: 740x300x400mm
• Concebido para aplicação em perfis de alumínio com fita LED artigo 5000 RSC50/PLED ou 5000 RSC50/PLED-ST (não incluído), para iluminar a área de trabalho

6,5 kg



RSC50 MTP

€ 297,00 1 050001305

RSC50 PS

painel para ferramentas com persiana, para combinar com mobiliário de oficina RSC50

- Persiana em alumínio, com regulação vertical e fechadura
- Painel de ferramentas perfurado e amovível
- Fornecido com estrutura
- Corresponde a bancada de trabalho de 1495 mm comp.

📦 77 kg



RSC50 PS € 2.620,00 1 050001360

RSC50 AC

canto completo, para combinar com mobiliário de oficina RSC50

Características:

- Bancada de trabalho em chapa pintada, 630x630x30 mm, com revestimento em PVC antichoque e antiriscos, resistente a hidrocarbonetos
- Dois painéis inferiores perfurados, 650x625x25 mm, permitem acomodar uma tomada múltipla de 19" (não incluída)
- Dois painéis superiores perfurados, 650x400x25 mm
- Fornecido com estrutura

📦 41 kg



RSC50 AC-A



RAL 7046



RSC50 AC-G

RSC50 AC-G € 2.040,00 1 050001330
RSC50 AC-A € 2.040,00 1 050001329

RSC50 KAI

canto, 630x630 mm, com pés

- Bancada em chapa metálica pintada (630x630mm) com tampo revestido a PVC anti-riscos e anti-impacto, resistente a hidrocarbonetos.

📦 16 kg



RSC50 KAI-A

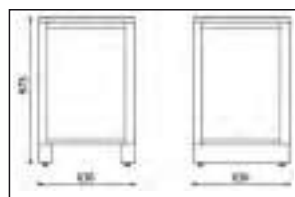

RAL 7046

RAL 7016



RSC50 KAI-G

RSC50 KAI-G € 1.180,00 1 050001335
RSC50 KAI-A € 1.180,00 1 050001336

RSC50 A1

armário para ferramentas em chapa metálica com uma porta, a combinar com mobiliário de oficina RSC50

- 4 prateleiras amovíveis com regulação vertical
- varão para vestuário sob a primeira prateleira
- com fechadura
- dimensões interiores 590x615 mm
- com pés com regulação vertical

📦 66 kg

RSC50 A1 € 925,00 1 050001411



RSC50 A1/R59

prateleira interior para armário de ferramentas RSC50 A1

RSC50 A1/R59 605x596 mm € 58,00 1 050001913

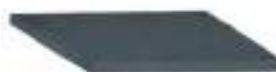

RSC50 A1/RB59

prateleira interior para armário de ferramentas RSC50 A1, com varão para vestuário

RSC50 A1/RB59 605x596 mm € 68,50 1 050001914



RSC50 A2

armário para ferramentas em chapa metálica com duas portas, para combinar com mobiliário de oficina RSC50

- 4 prateleiras amovíveis com regulação vertical
- Com fechadura
- Dimensões interiores: 910x615 mm
- Com pés ajustáveis verticalmente

📦 90 kg

RSC50 A2 € 1.420,00 1 050001412



RSC50 A2/R91

prateleira interior para armário de ferramentas RSC50 A2

RSC50 A2/R91 911x596 mm € 83,00 1 050001915



5000 RSC50/MP

prateleira para combinar com mobiliário de oficina RSC50

- Dimensões: 740x140x80mm
- Concebida para aplicação em perfis de alumínio com fita LED artigo 5000 RSC50/PLED ou 5000 RSC50/PLED-ST (não incluído), para iluminar a área de trabalho

2,3 kg



5 kg



5000 RSC50/MP

€ 134,00 1 050001705

5000 RSC50/MPA140

prateleira de canto, 140 mm profundidade, para combinar com mobiliário de oficina RSC50

- Dimensões: 630x630x35 mm, 140 mm profundidade
- Para aplicar em painéis perfurados do módulo de canto RSC50 AC
- Concebida para aplicação em perfis de alumínio com fita LED artigo 5000 RSC50/PLED ou 5000 RSC50/PLED-ST (não incluído), para iluminar a área de trabalho

3 kg



5 kg



5000 RSC50/MPA140

€ 178,00 1 050001706

5000 RSC50/CLL

resguardo linear para combinar com mobiliário de oficina RSC50

- Dimensões: 740x125x30 mm
- Para aplicar em painéis perfurados para ferramentas
- Concebido para aplicação em perfis de alumínio com fita LED artigo 5000 RSC50/PLED ou 5000 RSC50/PLED-ST (não incluído), para iluminar a área de trabalho

1 kg



5000 RSC50/CLL

€ 134,00 1 050001710

5000 RSC50/CAL

resguardo de canto para combinar com mobiliário de oficina RSC50

- Dimensões: 655x655x30 mm
- Para aplicar em painéis perfurados para ferramentas do módulo de canto
- Concebido para aplicação em perfis de alumínio com fitas LED artigo 5000 RSC50/PLED ou 5000 RSC50/PLED-ST (não incluído), para iluminar a área de trabalho

1,7 kg



5000 RSC50/CAL

€ 178,00 1 050001711

5000 RSC50/KFC

kit de 10 frentes de gaveta coloridas para combinar com mobiliário de oficina RSC50

Para personalizar a cor das frentes das gavetas para combinar com mobiliário de oficina RSC50. Recomendado para utilização em combinação com bancadas em cinza antracite RAL7016 (-A).

10x



Artigo	Cor	Preço (€)	Qtd	Código
5000 RSC50/KFC2011	Amarelo	93,50	1	050001731
5000 RSC50/KFC3000	Vermelho	93,50	1	050001733
5000 RSC50/KFC5015	Azul	93,50	1	050001734
5000 RSC50/KFC7016	Cinza	93,50	1	050001737

Beta

PROFISSIONAL ROBUSTO ORGANIZADO

C45PRO C45PRO é o equipamento de oficina profissional que o ajuda a tirar o melhor partido do seu espaço de trabalho. Baseado no novo design 2021 e nas melhorias técnicas desenvolvidas para a estrutura, possui uma excelente relação qualidade/preço.

O mobiliário modular para oficina, C45PRO, permite-lhe criar o seu próprio espaço de trabalho em função do espaço disponível e das suas necessidades de utilização. Esta linha simples e versátil, baseada em combinações pré-determinadas, pode expandir-se ou alterar-se ao longo do tempo. Em alternativa, pode personalizar completamente o seu posto de trabalho, começando pelas bancadas – disponíveis em MDF com revestimento em aço inoxidável ou madeira laminada – e complementando-as com os inúmeros componentes e acessórios que tem à sua disposição.

Personalize o seu local de trabalho para que se adeque às suas necessidades. Remodele a sua garagem ou oficina. Faça a sua escolha a partir das soluções pré-montadas ou crie o seu posto de trabalho de raiz.



O MOBILIÁRIO DE OFICINA, C45, MUDOU DE ASPETO E PASSOU A USAR AS CORES BETA!

Aceda a www.beta-tools.com



para configurar a sua oficina online

C45PRO DX

mobiliário para oficina C45PRO

Conjunto completo inclui:

- 1 bancada em MDF com revestimento aço inox (C45PX/3-2,0MT)
- 1 bancada em MDF com revestimento aço inox (C45PX/2-1,3MT)
- 1 módulo fixo com 7 gavetas (C45PRO M7)
- 1 carro de ferramentas com 7 gavetas (C45PRO C7)
- 1 módulo de serviço fixo (C45PRO MS)
- 1 módulo fixo com 5 gavetas (C45PRO M5)
- 1 módulo fixo com duas portas (C45PRO MA)
- 1 canto completo independente com tampo em MDF com revestimento aço inox (C45PRO CORNER/X)
- 5 painéis de ferramentas perfurados (C45PRO PF)
- 5 armários suspensos (C45PRO PM)
- 7 suportes de parede, tipo largo (C45PRO SL)
- 2 suportes de parede, tipo estreito (C45PRO SS)
- 2 armários de ferramentas com uma porta (C45PRO AS1)

572,3 kg

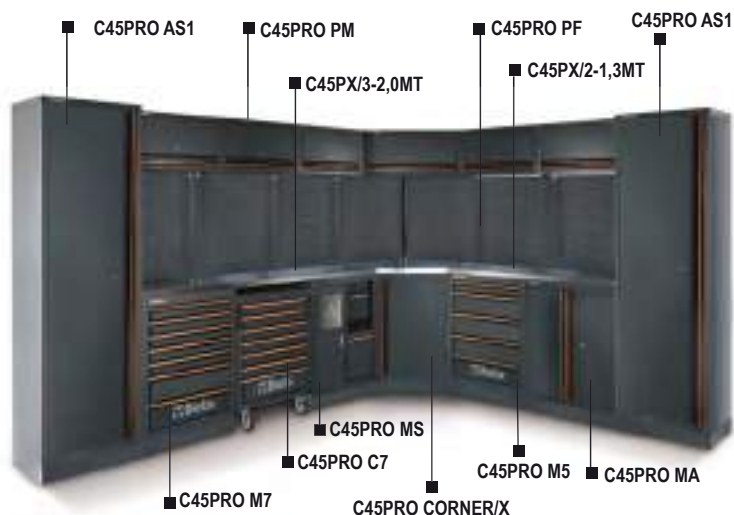

C45PRO DW

mobiliário para oficina C45PRO

Conjunto completo inclui:

- 1 bancada em madeira laminada (C45PW/3-2.0MT)
- 1 bancada em madeira laminada (C45PW/2-1.3MT)
- 1 módulo fixo com 7 gavetas (C45PRO M7)
- 1 carro de ferramentas com 7 gavetas (C45PRO C7)
- 1 módulo de serviço fixo (C45PRO MS)
- 1 módulo fixo com 5 gavetas (C45PRO M5)
- 1 módulo fixo com duas portas (C45PRO MA)
- 1 canto completo independente com tampo em madeira laminada (C45PRO CORNER/W)
- 5 painéis de ferramentas perfurados (C45PRO PF)
- 5 armários suspensos (C45PRO PM)
- 7 suportes de parede, tipo largo (C45PRO SL)
- 2 suportes de parede, tipo estreito (C45PRO SS)
- 2 armários de ferramentas com uma porta (C45PRO AS1)

568,5 kg

C45PRO DW 10.100,00 € 1 045000032

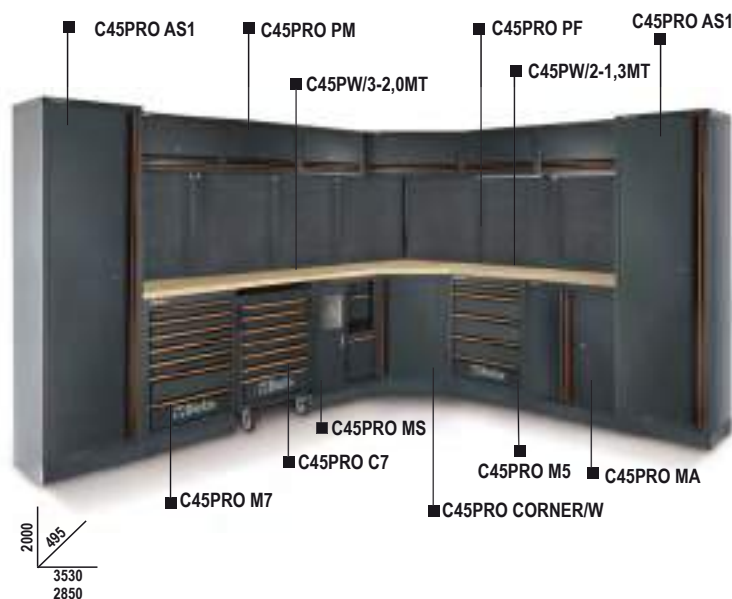

C45PRO FX

equipamento para garagem C45PRO

Inclui:

- 1 bancada em MDF com revestimento em aço inox (C45PX/3-2.0MT)
- 1 bancada em MDF com revestimento em aço inox (C45PX/2-1.3MT)
- 1 módulo fixo com duas portas (C45PRO MA)
- 1 carro de ferramentas com 7 gavetas (C45PRO C7)
- 1 módulo fixo com 7 gavetas (C45PRO M7)
- 1 módulo fixo com 2 enroladores integrados (C45PRO ACT)
- 1 módulo de serviço fixo (C45PRO MS)
- 1 canto completo com bancada em MDF com revestimento em aço inox (C45PRO CORNER/X)
- 2 painéis de ferramentas perfurados (C45PRO PF)
- 1 painel de ferramentas perfurado, com possibilidade de montagem de tomada (não incluída) (C45PRO PFE)
- 3 armários de parede (C45PRO PM)
- 1 painel de ferramentas com persiana em alumínio (C45PRO PAS)
- 6 suportes de parede, largos (C45PRO SL)
- 4 suportes de parede, estreito (C45PRO SS)
- 2 armários de uma porta (C45PRO AS1)

576 kg

C45PRO FX 11.000,00 € 1 045000035

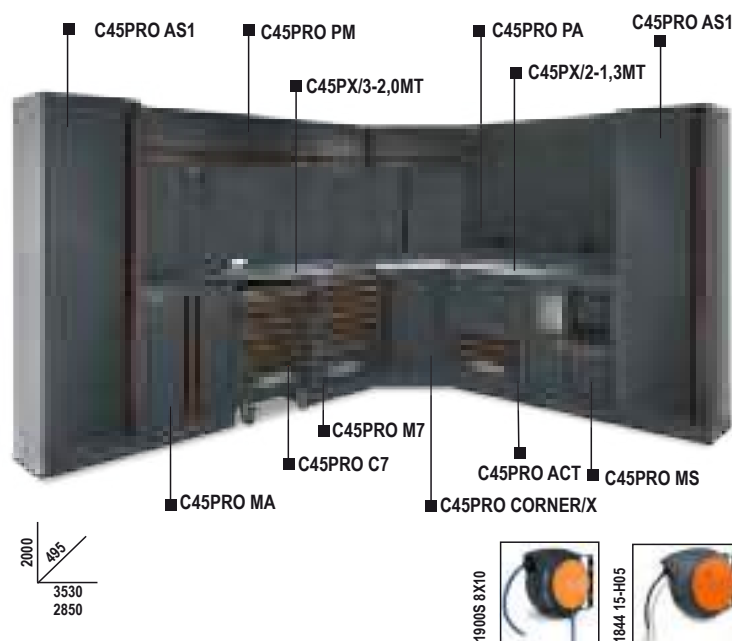

C45PRO FW

equipamento para garagem C45PRO

Inclui:

- 1 bancada em madeira laminada (C45PW/3-2.0MT)
- 1 bancada em madeira laminada (C45PW/2-1.3MT)
- 1 módulo fixo de duas portas (C45PRO MA)
- 1 carro de ferramentas com 7 gavetas (C45PRO C7)
- 1 módulo fixo com 7 gavetas (C45PRO M7)
- 1 módulo fixo com 2 enroladores integrados (C45PRO ACT)
- 1 módulo de serviço fixo (C45PRO MS)
- 1 canto completo com bancada em madeira laminada (C45PRO CORNER/W)
- 2 painéis de ferramentas perfurados (C45PRO PF)
- 1 painel de ferramentas perfurado, com possibilidade de montagem de tomada (não incluída) (C45PRO PFE)
- 3 armários de parede (C45PRO PM)
- 1 painel de ferramentas com persiana em alumínio (C45PRO PAS)
- 6 suportes de parede, largos (C45PRO SL)
- 4 suportes de parede, estreito (C45PRO SS)
- 2 armários de uma porta (C45PRO AS1)

572 kg

C45PRO FW 10.700,00 € 1 045000045

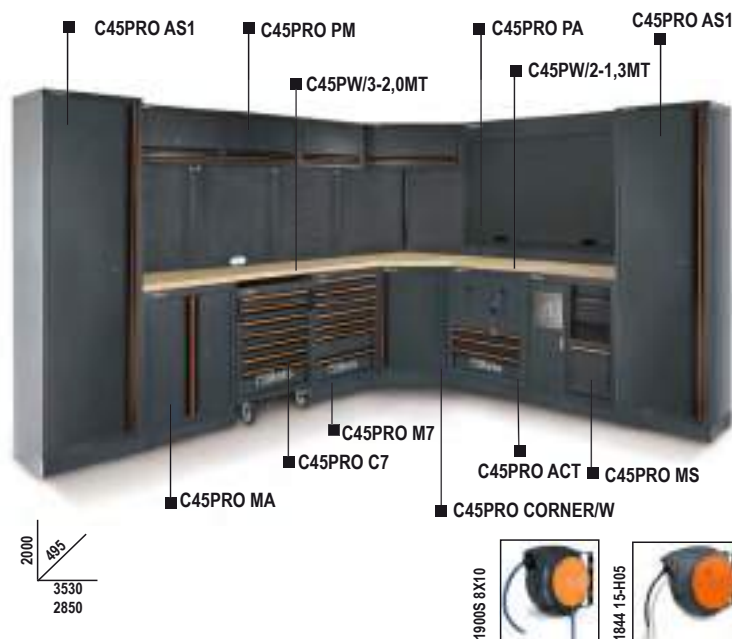

C45PRO GX

equipamento para garagem C45PRO

Inclui:

- 1 bancada em MDF com revestimento em aço inox (C45PX/3-2.0MT)
- 1 bancada em MDF com revestimento em aço inox (C45PX/1-0.7MT)
- 1 módulo fixo com 2 enroladores integrados (C45PRO ACT)
- 1 carro de ferramentas com 7 gavetas (C45PRO C7)
- 1 módulo fixo com 7 gavetas (C45PRO M7)
- 1 módulo fixo com duas portas (C45PRO MA)
- 1 canto completo com bancada em MDF com revestimento em aço inox (C45PRO CORNER/X)
- 1 painel de ferramentas perfurado (C45PRO PF)
- 1 painel de ferramentas perfurado, com possibilidade de montagem de tomada (não incluída) (C45PRO PFE)
- 2 armários de parede (C45PRO PM)
- 1 painel de ferramentas com persiana em alumínio (C45PRO PAS)
- 5 suportes de parede, largos (C45PRO SL)
- 4 suportes de parede, estreito (C45PRO SS)
- 2 armários de uma porta (C45PRO AS1)

507 kg

C45PRO GX 9.850,00 € 1 045000036

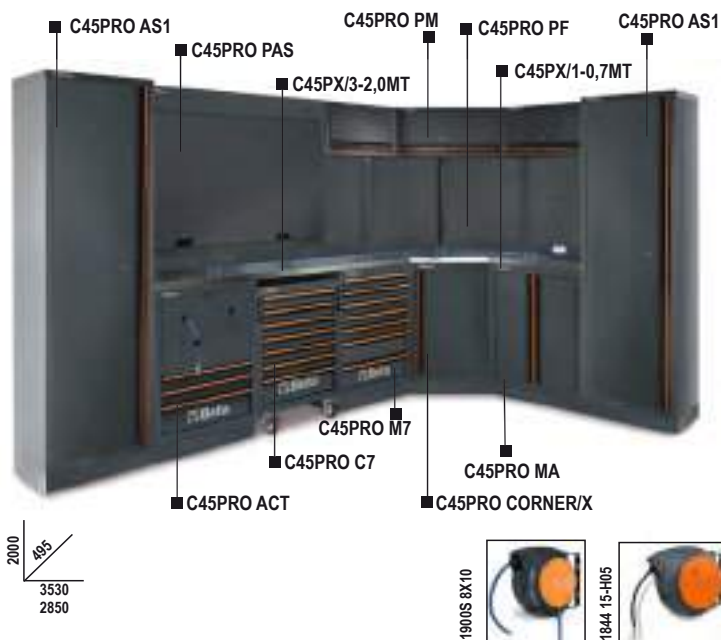

C45PRO GW

equipamento para garagem C45PRO

Inclui:

- 1 bancada em madeira laminada (C45PW/3-2.0MT)
- 1 bancada em madeira laminada (C45PW/1-0.7MT)
- 1 módulo fixo com 2 enroladores integrados (C45PRO ACT)
- 1 carro de ferramentas com 7 gavetas (C45PRO C7)
- 1 módulo fixo com 7 gavetas (C45PRO M7)
- 1 módulo fixo com lavatório integrado (C45PRO ML)
- 1 canto completo com bancada em madeira laminada (C45PRO CORNER/W)
- 1 painel de ferramentas perfurado (C45PRO PF)
- 1 painel de ferramentas perfurado, com possibilidade de montagem de tomada (não incluída) (C45PRO PFE)
- 2 armários de parede (C45PRO PM)
- 1 painel de ferramentas com persiana em alumínio (C45PRO PAS)
- 6 suportes de parede, largos (C45PRO SL)
- 2 suportes de parede, largos (C45PRO SS)
- 2 armários de uma porta (C45PRO AS1)

504 kg

C45PRO GW 9.550,00 € 1 045000037

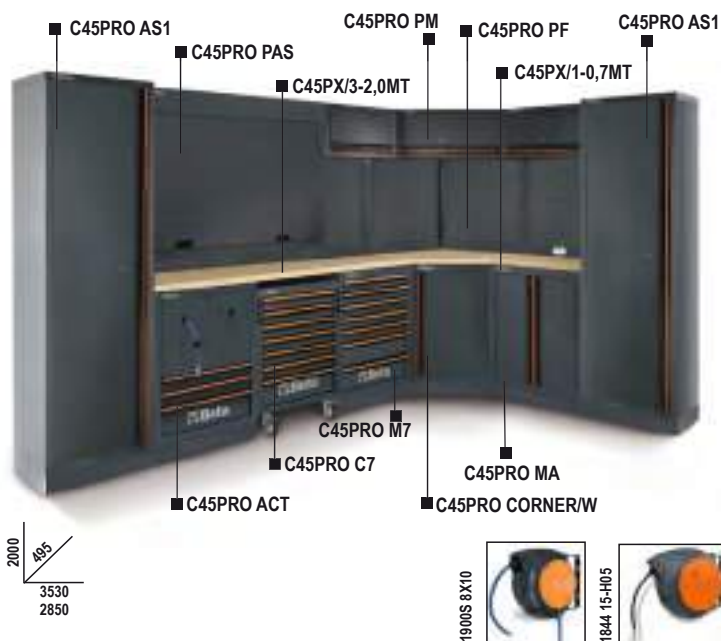

C45PRO X

mobiliário para oficina C45PRO

Conjunto completo inclui:

- Bancada em MDF com revestimento aço inox (C45PX/3-2.0MT)
- Módulo fixo com 7 gavetas (C45PRO M7)
- Carro de ferramentas com 7 gavetas (C45PRO C7)
- Módulo de serviço fixo (C45PRO MS)
- 3 painéis de ferramentas perfurados (C45PRO PF)
- 3 armários suspensos (C45PRO PM)
- 3 suportes de parede, tipo largo (C45PRO SL)
- 1 suporte de parede, tipo estreito (C45PRO SS)
- Armário para ferramentas com duas portas (C45PRO AS2)

305 kg

C45PRO X 5.250,00 € 1 045000001



C45PRO W

mobiliário para oficina C45PRO

Conjunto completo inclui:

- Bancada em madeira laminada (C45PW/3-2.0MT)
- Módulo fixo com 7 gavetas (C45PRO M7)
- Carro de ferramentas com 7 gavetas (C45PRO C7)
- Módulo de serviço fixo (C45PRO MS)
- 3 painéis de ferramentas perfurados (C45PRO PF)
- 3 armários suspensos (C45PRO PM)
- 3 suportes de parede, tipo largo (C45PRO SL)
- 1 suporte de parede, tipo estreito (C45PRO SS)
- Armário para ferramentas com duas portas (C45PRO AS2)

303 kg

C45PRO W

€ 5.150,00 1 045000002



C45PRO HX

equipamento para garagem C45PRO

Inclui:

- 1 bancada em MDF com revestimento em aço inox (C45PX/3-2.0MT)
- 1 módulo fixo com 2 enroladores integrados (C45PRO ACT)
- 1 carro de ferramentas com 7 gavetas (C45PRO C7)
- 1 módulo fixo com 4 gavetas (C45PRO M4)
- 3 armários de parede (C45PRO PM)
- 3 painéis de ferramentas perfurados (C45PRO PF)
- 3 suportes de parede, largos (C45PRO SL)
- 1 suporte de parede, estreito (C45PRO SS)
- 1 armário de duas portas (C45PRO AS2)

300 kg

C45PRO HX

€ 5.650,00 1 045000038



C45PRO HW

equipamento para garagem C45PRO

Inclui:

- 1 bancada em madeira laminada (C45PW/3-2.0MT)
- 1 módulo fixo com 2 enroladores integrados (C45PRO ACT)
- 1 carro de ferramentas com 7 gavetas (C45PRO C7)
- 1 módulo fixo com 4 gavetas (C45PRO M4)
- 3 armários de parede (C45PRO PM)
- 3 painéis de ferramentas perfurados (C45PRO PF)
- 3 suportes de parede, largos (C45PRO SL)
- 1 suporte de parede, estreito (C45PRO SS)
- 1 armário de duas portas (C45PRO AS2)

299 kg

C45PRO HW

€ 5.550,00 1 045000039

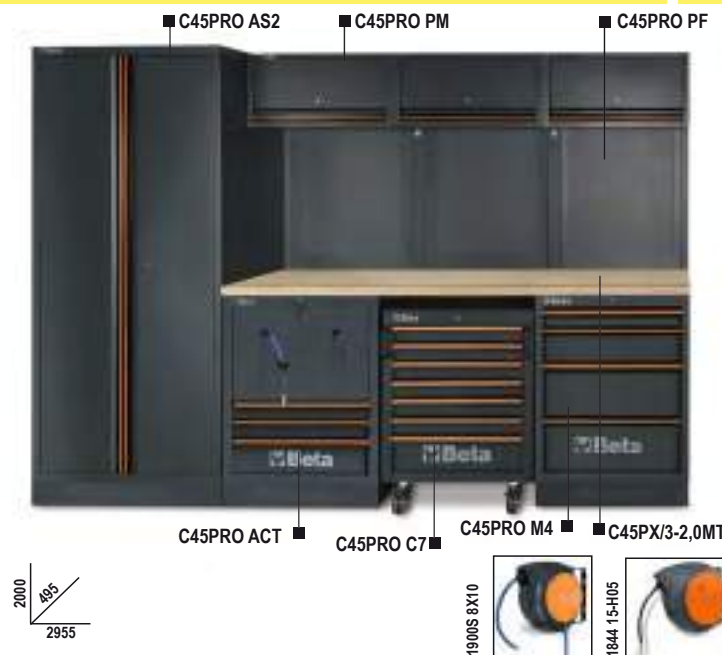

C45PRO AX

mobiliário para oficina C45PRO

Conjunto completo inclui:

- Bancada MDF com revestimento aço inox (C45PX/3-2,0MT)
- Módulo de serviço fixo (C45PRO MS)
- Módulo fixo com 7 gavetas (C45PRO M7)
- Módulo fixo com duas portas (C45PRO MA)
- 3 armários suspensos (C45PRO PM)
- 3 painéis de ferramentas perfurados (C45PRO PF)
- 2 suportes de parede, tipo largo (C45PRO SL)
- 2 suportes de parede, tipo estreito (C45PRO SS)

206 kg

C45PRO AX 3.650,00 € 1 045000003



C45PRO AW

bancada de trabalho, a combinar com mobiliário para oficina C45PRO

Conjunto completo inclui:

- Bancada em madeira laminada (C45PW/3-2,0MT)
- Módulo de serviço fixo (C45PRO MS)
- Módulo fixo com 7 gavetas (C45PRO M7)
- Módulo fixo com 2 gavetas (C45PRO MA)
- 3 armários suspensos (C45PRO PM)
- 3 painéis de ferramentas perfurados (C45PRO PF)
- 2 suportes de parede, tipo estreito (C45PRO SS)
- 2 suportes de parede, tipo largo (C45PRO SL)

204 kg

C45PRO AW 3.510,00 € 1 045000004



C45PRO BX

mobiliário para oficina C45PRO

Conjunto completo inclui:

- Bancada em MDF com revestimento aço inox (C45PX/2-1,3MT)
- Módulo fixo com 5 gavetas (C45PRO M5)
- Módulo fixo com duas portas (C45PRO MA)
- 2 armários suspensos (C45PRO PM)
- 2 painéis de ferramentas perfurados (C45PRO PF)
- 2 suportes de parede, tipo largo (C45PRO SL)
- 1 suporte de parede, tipo estreito (C45PRO SS)
- Armário para ferramentas com uma porta (C45PRO AS1)

191 kg

C45PRO BX 3.290,00 € 1 045000021



C45PRO BW

mobiliário para oficina C45PRO

Conjunto completo inclui:

- Bancada em madeira laminada (C45PW/2-1.3MT)
- Módulo fixo com 5 gavetas (C45PRO M5)
- Módulo fixo com duas portas (C45PRO MA)
- 2 armários suspensos (C45PRO PM)
- 2 painéis de ferramentas perfurados (C45PRO PF)
- 2 suportes de parede, tipo largo (C45PRO SL)
- 1 suporte de parede, tipo estreito (C45PRO SS)
- Armário para ferramentas com uma porta (C45PRO AS1)

190 kg

C45PRO BW

€ 3.150,00 1 045000022



C45PRO EX

mobiliário para oficina C45PRO

Conjunto completo inclui:

- 2 painéis de ferramentas perfurados (C45PRO PF)
- 2 armários suspensos (C45PRO PM)
- 2 suportes de parede, tipo largo (C45PRO SL)
- 1 suporte de parede, tipo estreito (C45PRO SS)
- 1 armário com uma porta (C45PRO AS1)
- Módulo fixo com 7 gavetas e bancada em MDF com revestimento aço inox (C45PRO M7A/X):
 - 1 gaveta, 1248x406 mm
 - 6 gavetas, 782x406 mm
 - 5 gavetas, 65 mm altura
 - 1 gaveta, 145 mm altura
- 1 compartimento de arrumação com prateleira intermédia e porta

174,6 kg

C45PRO EX

€ 3.490,00 1 045000033



C45PRO EW

mobiliário para oficina C45PRO

Conjunto completo inclui:

- 2 painéis de ferramentas perfurados (C45PRO PF)
- 2 armários suspensos (C45PRO PM)
- 2 suportes de parede, tipo largo (C45PRO SL)
- 1 suporte de parede, tipo estreito (C45PRO SS)
- 1 armário com uma porta (C45PRO AS1)
- Módulo fixo com 7 gavetas e bancada em madeira laminada (C45PRO M7A/W):
 - 1 gaveta, 1248x406 mm
 - 6 gavetas, 782x406 mm
 - 5 gavetas, 65 mm altura
 - 1 gaveta, 145 mm altura
- 1 compartimento de arrumação com prateleira intermédia e porta

173,6 kg

C45PRO EW

€ 3.380,00 1 045000034



C45PRO CX

mobiliário para oficina C45PRO

Conjunto completo inclui:

- Bancada em MDF com revestimento aço inox (C45PX/2-1.3MT)
- Módulo de serviço fixo (C45PRO MS)
- Módulo fixo com 7 gavetas (C45PRO M7)
- 2 armários suspensos (C45PRO PM)
- 2 painéis de ferramentas perfurados (C45PRO PF)
- 2 suportes de parede, tipo largo (C45PRO SL)
- 1 suporte de parede, tipo estreito (C45PRO SS)
- Armário com uma porta (C45PRO AS1)

199 kg

C45PRO CX € 3.520,00 1 045000023



C45PRO CW

mobiliário para oficina C45PRO

Conjunto completo inclui:

- Bancada em madeira laminada (C45PW/2-1.3MT)
- Módulo de serviço fixo (C45PRO MS)
- Módulo fixo com 7 gavetas (C45PRO M7)
- 2 armários suspensos (C45PRO PM)
- 2 painéis de ferramentas perfurados (C45PRO PF)
- 2 suportes de parede, tipo largo (C45PRO SL)
- 1 suporte de parede, tipo estreito (C45PRO SS)
- Armário com uma porta (C45PRO AS1)

198 kg

C45PRO CW € 3.390,00 1 045000024



C45PRO BPX-2,0

bancada de trabalho, a combinar com mobiliário para oficina C45PRO

Conjunto completo inclui:

- Bancada em MDF com revestimento aço inox (C45PX/3-2.0MT)
- Módulo fixo com 7 gavetas (C45PRO M7)
- Módulo fixo com 5 gavetas (C45PRO M5)
- 3 Painel de ferramentas perfurados (C45PRO PF)
- 2 suportes de parede, tipo largo (C45PRO SL)
- 2 suportes de parede, tipo estreito (C45PRO SS)

158 kg

C45PRO BPX-2,0 € 2.660,00 1 045000042



C45PRO BPW-2,0

bancada de trabalho, a combinar com mobiliário para oficina C45PRO

Conjunto completo inclui:

- Bancada em madeira laminada (C45PW/3-2,0MT)
- Módulo fixo com 7 gavetas (C45PRO M7)
- Módulo fixo com 5 gavetas (C45PRO M5)
- 3 Painel de ferramentas perfurados (C45PRO PF)
- 2 suportes de parede, tipo largo (C45PRO SL)
- 2 suportes de parede, tipo estreito (C45PRO SS)

156 kg

C45PRO BPW-2,0

€ 2.520,00 1 045000052



C45PRO BPX-1,3

bancada de trabalho, a combinar com mobiliário para oficina C45PRO

Conjunto completo inclui:

- Bancada em MDF com revestimento aço inox (C45PX/2-1.3MT)
- Módulo fixo com 7 gavetas (C45PRO M7)
- Módulo fixo com 5 gavetas (C45PRO M5)
- 2 painéis de ferramentas perfurados (C45PRO PF)
- 1 suporte de parede, tipo largo (C45PRO SL)
- 2 suportes de parede, tipo estreito (C45PRO SS)

140 kg

C45PRO BPX-1,3

€ 2.360,00 1 045000041



C45PRO BPW-1,3

bancada de trabalho, a combinar com mobiliário para oficina C45PRO

Conjunto completo inclui:

- Bancada em madeira laminada (C45PW/2-1.3MT)
- Módulo fixo com 7 gavetas (C45PRO M7)
- Módulo fixo com 5 gavetas (C45PRO M5)
- 2 painéis de ferramentas perfurados (C45PRO PF)
- 1 suporte de parede, tipo largo (C45PRO SL)
- 2 suportes de parede, tipo estreito (C45PRO SS)

139 kg

C45PRO BPW-1,3

€ 2.230,00 1 045000051



C45PRO M7A/X

módulo fixo com 7 gavetas, a combinar com mobiliário de oficina C45PRO

- superfície de trabalho (1360 mm) em aço inox com revestimento MDF
- 1 gaveta (1248x406 mm) com guias de rolamentos de esferas
- 6 gavetas (782x406 mm) com guias de rolamentos de esferas:
- 5 gavetas 65 mm altura
- 1 gaveta 145 mm altura
- fundo das gavetas protegido com tapete de borracha
- fechadura frontal centralizada
- pés ajustáveis verticalmente
- pode ser equipado com bandejas em espuma
- 1 compartimento com prateleira e porta, dimensões interiores 504x424x597 mm
- permite instalação de torno (1599P/150, a encomendar separadamente)

81 kg

C45PRO M7A/X € 1.760,00 1 045000161



h	max
65 mm	25 kg
105 mm	40 kg
145 mm	30 kg

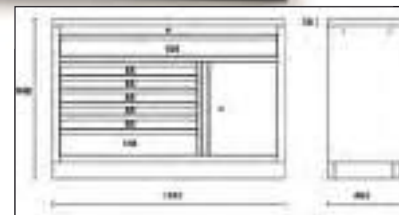

C45PRO M7A/W

módulo fixo com 7 gavetas, a combinar com mobiliário de oficina C45PRO

- superfície de trabalho em madeira laminada (1360 mm)
- 1 gaveta (1248x406 mm) com guias de rolamentos de esferas
- 6 gavetas (782x406 mm) com guias de rolamentos de esferas:
- 5 gavetas 65 mm altura
- 1 gaveta 145 mm altura
- fundo das gavetas protegido com tapete de borracha
- fechadura frontal centralizada
- pés ajustáveis verticalmente
- pode ser equipado com bandejas em espuma
- 1 compartimento com prateleira e porta, dimensões interiores 504x424x597 mm
- permite instalação de torno (1599P/150, a encomendar separadamente)

80 kg

C45PRO M7A/W € 1.650,00 1 045000171



h	max
65 mm	25 kg
105 mm	40 kg
145 mm	30 kg

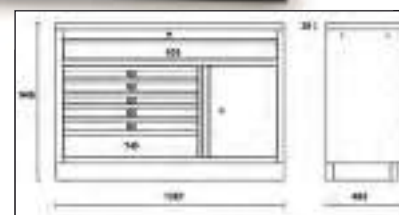

C45PRO MWS/X

carro Posto de Serviço com 7 gavetas e caixote do lixo integrado

- superfície de trabalho (1680 mm) em aço inox com revestimento MDF
- 1 gaveta (1248x406 mm) com guias de rolamentos de esferas
- 6 gavetas (782x406 mm) com guias de rolamentos de esferas:
- 5 gavetas 65 mm altura
- 1 gaveta 145 mm altura
- fundo das gavetas protegido com tapete de borracha
- pode ser equipado com bandejas em espuma
- 1 compartimento com prateleira e porta, dimensões interiores 504x424x597 mm
- caixote do lixo integrado
- compartimento para rolo de papel integrado
- 4 rodízios muito robustos, Ø 150 mm, 2 fixos e 2 direcionáveis com travão
- fechadura frontal centralizada
- permite instalação de torno (1599P/150, a encomendar separadamente)

126 kg

C45PRO MWS/X € 1.870,00 1 045000181



h	max
65 mm	25 kg
105 mm	40 kg
145 mm	30 kg

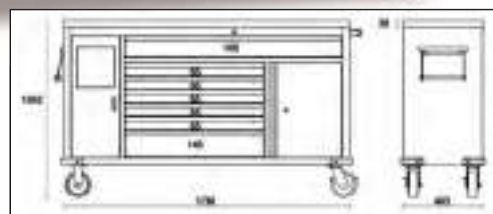

C45PRO MWS/W

carro Posto de Serviço com 7 gavetas e caixote do lixo integrado

- superfície de trabalho (1680 mm) em madeira laminada
- 1 gaveta (1248x406 mm) com guias de rolamentos de esferas
- 6 gavetas (782x406 mm) com guias de rolamentos de esferas:
 - 5 gavetas 65 mm altura
 - 1 gaveta 145 mm altura
- fundo das gavetas protegido com tapete de borracha
- pode ser equipado com bandejas em espuma
- 1 compartimento com prateleira e porta, dimensões interiores 504x424x597 mm
- caixote do lixo integrado
- compartimento para rolo de papel integrado
- 4 rodízios muito robustos, Ø 150 mm, 2 fixos e 2 direcionáveis com travão
- fechadura frontal centralizada
- permite instalação de torno (1599P/150, a encomendar separadamente)

122 kg

C45PRO MWS/W

€ 1.820,00 1 045000191



h	max
65 mm	25 kg
105 mm	40 kg
145 mm	30 kg

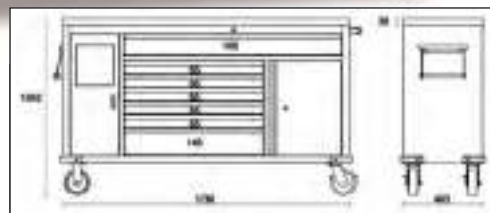

C45PRO CPF

par de painéis de ferramentas perfurados para carro C45PRO MWS

Fornecido com estrutura
Kit de 50 ganchos GPS incluído

21 kg

C45PRO CPF

€ 242,00 1 045000195

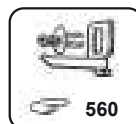

C45PX/1-0,7MT

superfície de trabalho em MDF com revestimento aço inox, 680x463 mm, para bancada, a combinar com mobiliário para oficina C45PRO

- espessura: 38 mm
- permite instalação de torno (1599P/150, a encomendar separadamente)

6 kg

C45PX/1-0,7MT

€ 227,00 1 045000101



C45PW/1-0,7MT

superfície de trabalho em madeira laminada, 680x463 mm, para bancada, a combinar com mobiliário de oficina C45PRO

- espessura: 38 mm
- permite instalação de torno (1599P/150, a encomendar separadamente)

6 kg

C45PW/1-0,7MT

€ 134,00 1 045000111



C45PX/2-1,3MT

superfície de trabalho em aço inox com revestimento MDF, 1360x463 mm, para bancada, a combinar com mobiliário de oficina C45PRO

- espessura: 38 mm
- permite instalação de torno (1599P/150, a encomendar separadamente)

📦 21 kg

C45PX/2-1,3MT € 362,00 1 045000103



C45PW/2-1,3MT

superfície de trabalho em madeira laminada, 1360x463 mm, para bancada, a combinar com mobiliário de oficina C45PRO

- espessura: 38 mm
- permite instalação de torno (1599P/150, a encomendar separadamente)

📦 20 kg

C45PW/2-1,3MT € 231,00 1 045000113



C45PX/3-2,0MT

superfície de trabalho em aço inox com revestimento MDF, 2040x463 mm, para bancada, a combinar com mobiliário de oficina C45PRO

- espessura: 38 mm
- permite instalação de torno (1599P/150, a encomendar separadamente)

📦 31,8 kg

C45PX/3-2,0MT € 485,00 1 045000110



C45PW/3-2,0MT

superfície de trabalho em madeira laminada, 2040x463 mm, para bancada, a combinar com mobiliário de oficina C45PRO

- espessura: 38 mm
- permite instalação de torno (1599P/150, a encomendar separadamente)

📦 30 kg

C45PW/3-2,0MT € 346,00 1 045000120



C45PRO C5

carro com 5 gavetas, para combinar com equipamento para oficina C45PRO

- 5 gavetas (532x406 mm) com guias de rolamentos de esferas
- 4 rodízios giratórios, Ø 100 mm (2 com travão)
- Bases das gavetas com tapetes em borracha
- Fechadura frontal centralizada
- Possibilidade de equipar com tabuleiros maleáveis
- Pegas integradas na estrutura para manuseamento mais fácil

📦 46 kg

C45PRO C5 € 845,00 1 045000225

65 mm	25 kg
145 mm	30 kg

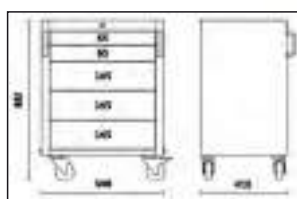

C45PRO C7

carro com 7 gavetas, a combinar com mobiliário para oficina C45PRO

- 7 gavetas (532x406 mm) com guias de rolamentos de esfera
- 4 rodas direcionáveis, Ø 100 mm (2 com travão)
- Fundo das gavetas protegido com tapete de borracha
- Fechadura centralizada de segurança frontal
- Pode ser equipado com tabuleiros flexíveis
- Punho incorporados na estrutura para maior facilidade de manuseamento

📦 50 kg

h	max
65 mm	25 kg
145 mm	30 kg

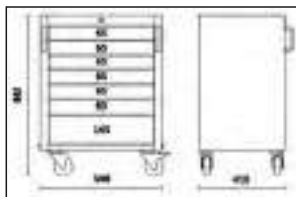

C45PRO C7

€ 885,00 1 045000227

C45PRO M4

módulo fixo com 4 gavetas, a combinar com mobiliário para oficina C45PRO

- 4 gavetas (566x406 mm) com guias de rolamentos de esfera
- Fundo das gavetas protegido com tapete de borracha
- Fechadura centralizada de segurança frontal
- Com pés com regulação vertical
- Pode ser equipado com tabuleiros flexíveis

📦 45,7 kg

h	max
65 mm	25 kg
145 mm	30 kg
225 mm	30 kg

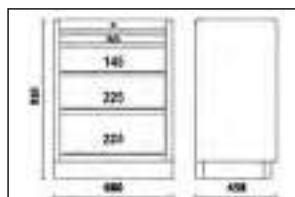

C45PRO M4

€ 725,00 1 045000234

C45PRO M5

módulo fixo com 5 gavetas, a combinar com mobiliário para oficina C45PRO

- 5 gavetas (566x406 mm) com guias de rolamentos de esfera
- Fundo das gavetas protegido com tapete de borracha
- Fechadura centralizada de segurança frontal
- Com pés com regulação vertical
- Pode ser equipado com tabuleiros flexíveis

📦 49,3 kg

h	max
65 mm	25 kg
145 mm	30 kg

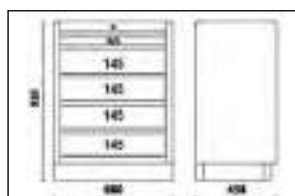

C45PRO M5

€ 770,00 1 045000235

C45PRO M7

módulo fixo com 7 gavetas, a combinar com mobiliário para oficina C45PRO

- 7 gavetas (566x406 mm) com guias de rolamentos de esfera
- Fundo das gavetas protegido com tapete de borracha
- Fechadura centralizada de segurança frontal
- Com pés com regulação vertical
- Pode ser equipado com tabuleiros flexíveis

54,3 kg

65 mm	25 kg
145 mm	30 kg

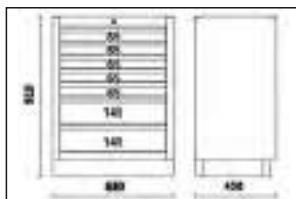
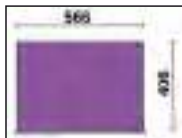

C45PRO M7

€ 855,00 1 045000237

C45PRO M8

módulo fixo com 8 gavetas, para combinar com equipamento para oficina C45PRO

- 8 gavetas (566x406 mm) com guias de rolamentos de esferas
- Bases das gavetas com tapetes em borracha
- Fechadura frontal centralizada
- Pés ajustáveis em altura
- Possibilidade de equipar com tabuleiros maleáveis

56,5 kg

65 mm	25 kg
145 mm	30 kg

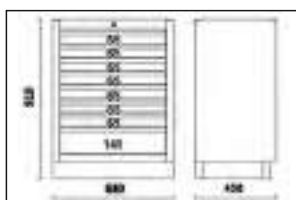
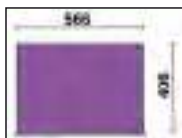

C45PRO M8

€ 930,00 1 045000238

C45PRO MS

módulo de serviço fixo, a combinar com mobiliário para oficina C45PRO

- Caixote de lixo incorporado
- Compartimento para rolo de papel
- Com pés com regulação vertical

37 kg

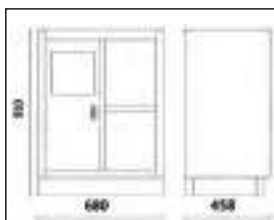

C45PRO MS

€ 580,00 1 045000239

C45PRO RD/X

módulo de ecoponto fixo para combinar com equipamento para oficina C45PRO

A solução ideal para separação de lixos (vidro, papel, plástico...)

- Bancada em MDF com revestimento aço inox, 1360 mm comprimento
- Robusta estrutura em chapa metálica com 4 caixotes com porta basculante para separação de resíduos
- Cada compartimento está equipado com:
 - um caixote de plástico amovível; capacidade: 25 l
 - 4 rodízios giratórios, Ø 60 mm
- Fornecido com kit de 4 fitas adesivas coloridas
- Pés reguláveis em altura

80 kg

C45PRO RD/X	€ 1.790,00	1	045000241
C45PRO RD/W	€ 1.670,00	1	045000240



C45PRO RD/X



C45PRO RD/W

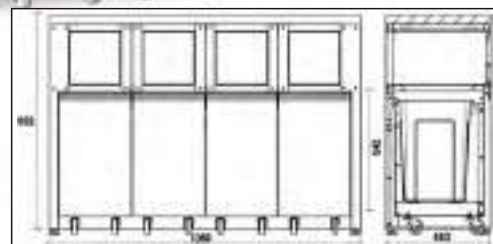

C45PRO MA

módulo fixo com duas portas, a combinar com mobiliário para oficina C45PRO

- Com fechadura
- Prateleira interior ajustável verticalmente
- Dimensões interiores 670x420 mm
- Com pés com regulação vertical

29,4 kg

C45PRO MA	€ 430,00	1	045000232
-----------	----------	---	-----------

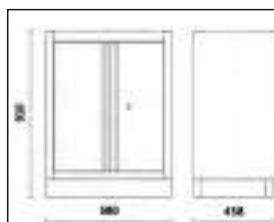

C45PRO MAL

módulo fixo, 1360 mm comprimento, com 2 portas, a combinar com mobiliário para oficina C45PRO

- Com fechadura
- Prateleira ajustável verticalmente
- Dimensões interiores: 670x420 mm
- Pés ajustáveis verticalmente

44,8 kg

C45PRO MAL	€ 760,00	1	045000229
------------	----------	---	-----------

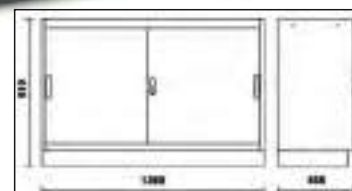

C45PRO MAT

módulo fixo, 1360 mm comprimento, com 2 portas em policarbonato transparente, a combinar com mobiliário para oficina C45PRO

- Portas em policarbonato transparente
- Com fechadura
- Prateleira ajustável verticalmente
- Dimensões interiores: 670x420 mm
- Pés ajustáveis verticalmente

📦 44,1 kg

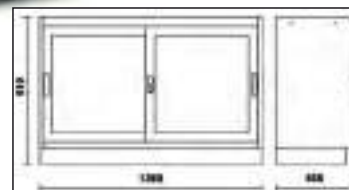

C45PRO MAT

€ 830,00 1 045000230

C45PRO M3A

módulo fixo com 3 gavetas e 2 portas, para combinar com equipamento para oficina C45PRO

- 3 gavetas (566x406 mm) com guias de rolamentos de esferas
- Bases das gavetas com tapetes em borracha
- Possibilidade de equipar com tabuleiros maleáveis
- Fechadura frontal centralizada
- Compartimento de arrumação com porta dupla e fechadura dimensões interiores 670x440 mm), com prateleira intermédia
- Pés ajustáveis em altura

📦 44 kg

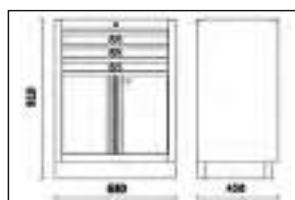

C45PRO M3A

€ 745,00 1 045000231

C45PRO ML

módulo fixo com lavatório, a combinar com mobiliário para oficina C45PRO

Características técnicas:

- Lavatório em aço inox.
- Fornecido com:
 - 1 torneira misturadora
 - 1 unidade de drenagem
 - 1 tampa do ralo
 - 1 tampa do filtro
 - 1 dispensador de sabão

módulo fixo com duas portas e fechadura:

- Dimensões interiores 600x603x416 mm
- Com pés com regulação vertical

📦 44 kg

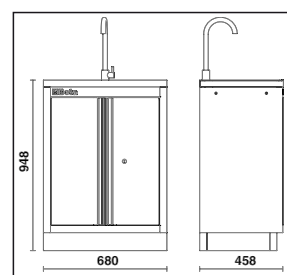

C45PRO ML

€ 1.170,00 1 045000233

C45PRO ACT

módulo fixo com 3 gavetas e 2 enroladores, a combinar com mobiliário para oficina C45PRO

- 3 gavetas (566x406 mm) com guias de rolamentos de esfera
- Fundo das gavetas protegido com tapete de borracha
- Fechadura centralizada de segurança frontal
- Com pés com regulação vertical

Completo com:

- 1 enrolador de tubo de ar comprimido ou água fria, Ø 8 mm, comp. 10 m, item 1900S 8x10
- 1 enrolador de cabo elétrico, comp. 15 m, item 1844 15-H05

47 kg

C45PRO ACT

€ 1.110,00 1 045000247



h	max
65 mm	25 kg
145 mm	30 kg

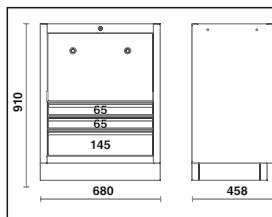

C45PRO TC

módulo fixo para enrolador com 3 gavetas, a combinar com mobiliário para oficina C45PRO, vazio

- 3 gavetas (566x406 mm) com guias de rolamentos de esfera
- Fundo das gavetas protegido com tapete de borracha
- Fechadura centralizada de segurança frontal
- Com pés com regulação vertical

• Pode ser equipado com 2 enroladores, a escolher de entre os seguintes:

- 2 enroladores de tubo de ar comprimido ou água fria, Ø 8 mm, comp. 10 m, item 1900S 8x10
- 2 enroladores de cabo elétrico, a escolher de entre os seguintes itens: 1843 15-H05, 1844 10-H05, 1844 15-H05, 1844 15-H07, 1845 12-H05, 1846 10-H05, 1846 10-H07 e 1846 15-H05
- 1 enrolador de tubo de ar comprimido ou água fria, Ø 8 mm, comp. 10 m, item 1900S 8x10, e 1 enrolador de cabo elétrico, a escolher de entre os itens acima referidos

38 kg

C45PRO TC

€ 675,00 1 045000249

h	max
65 mm	25 kg
145 mm	30 kg

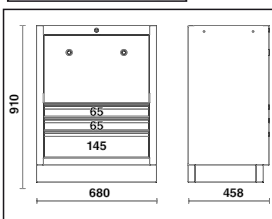

C45PRO T3

carro de 3 níveis, para combinar com equipamento para oficina C45PRO

- Duas opções de fixação da prateleira central
- 4 rodízios giratórios, Ø 100 mm (dois com travões)
- Capacidade de carga estática: 200 kg (distribuídos pelas 3 prateleiras)

19,2 kg

C45PRO T3

€ 336,00 1 045000250

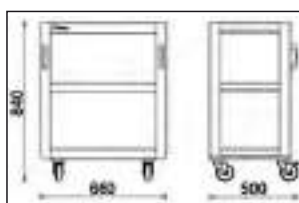

C45PRO SS

suportes de parede, tipo estreito, a combinar com mobiliário para oficina C45PRO

- Dimensões 1420x32.5x30 mm

1,5 kg



C45PRO SS

€ 32,50 1 045000333

C45PRO SL

suportes de parede, tipo largo, a combinar com mobiliário para oficina C45PRO

- Dimensões 1420x65x30 mm

2 kg



C45PRO SL

€ 43,50 1 045000366

C45PRO PAS

sistema de parede para ferramentas para combinar com equipamento para oficina C45PRO

- Persiana em alumínio, regulação em altura, com fechadura
- Dois painéis perfurados amovíveis
- Adequado para bancada com 1.3 m comprimento

48,8 kg

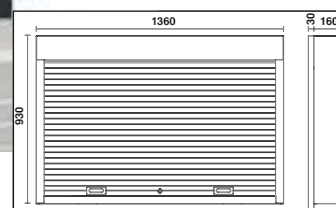

C45PRO PAS

€ 1.090,00 1 045000290

C45PRO PF

painel de ferramentas perfurado, a combinar com mobiliário para oficina C45PRO

- Dimensões 1052x614.5x24 mm

5,3 kg



C45PRO PF

€ 135,00 1 045000313

C45PRO PFE

painel de ferramentas perfurado, a combinar com mobiliário para oficina C45PRO

- Dimensões 1052x614,5x24 mm
- Pode ser equipado com 1 tomada elétrica (não incluída)

📦 5,3 kg



C45PRO PFE

€ 129,00 1 045000312



C45PRO MP

prateleira em aço para painéis de ferramentas perfurados, a combinar com mobiliário de oficina C45PRO

Dimensões: 614x160x80 mm

📦 1,8 kg

C45PRO MP

€ 58,00 1 045000315



C45PRO CORNER/X

canto completo, a combinar com mobiliário para oficina C45PRO

- Armário de canto suspenso com molas de gás, para fácil abertura/fecho das portas
- 2 painéis de ferramentas perfurados (1052x860)
- Plano de trabalho em aço inox (860x860 mm)
- Módulo inferior com compartimento de arrumação de grandes dimensões
- Com pés com regulação vertical

📦 94 kg

C45PRO CORNER/X

€ 2.200,00 1 045000401



Beta

C45PRO CORNER/W

canto completo, a combinar com mobiliário para oficina C45PRO

- Armário de canto suspenso com molas de gás, para fácil abertura/fecho das portas
- 2 painéis de ferramentas perfurados (1052x860 mm)
- Plano de trabalho em madeira laminada (860x860 mm)
- Módulo inferior com compartimento de arrumação de grandes dimensões
- Com pés com regulação vertical

📦 93 kg

C45PRO CORNER/W € 2.130,00 1 045000411

C45PRO CAI/X

módulo de canto inferior para combinar com equipamento para oficina C45PRO

- Superfície de trabalho em MDF com revestimento em aço inoxidável, 860x860 mm
- Módulo de canto fixo com grande compartimento de arrumação
- Pés ajustáveis em altura

📦 62 kg

C45PRO CAI/X € 1.210,00 1 045000412

C45PRO CAI/W

módulo de canto inferior para combinar com equipamento para oficina C45PRO

- Superfície de trabalho em madeira laminada (860x860 mm)
- Módulo de canto fixo com grandes compartimento de arrumação
- Pés ajustáveis em altura

📦 56 kg

C45PRO CAI/W € 1.130,00 1 045000402

C45PRO PM

armário suspenso, a combinar com mobiliário para oficina C45PRO

- Comprimento: 680 mm
- Com molas a gás, para facilitar a abertura e fecho da porta
- Com cadeado

📦 10 kg

C45PRO PM € 249,00 1 045000302

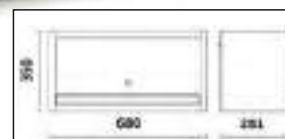

SSPE

suporte para colocação sob o armário de ferramentas elétricas

- Para utilização apenas sob o armário suspenso C45PRO PM (equipamento de oficina C45PRO)
- Com 5 compartimentos convenientes para ferramentas elétricas
- Dimensões: 680 x 280 x 150 mm

📦 5,4 kg



SSPE

€ 108,00 1 088880482

C45PRO PML

armário de parede, longo, para combinar com equipamento para oficina C45PRO

- Comprimento: 1360 mm
- Com molas a gás, para fechar e abrir a porta com facilidade
- Com fechadura

📦 18 kg

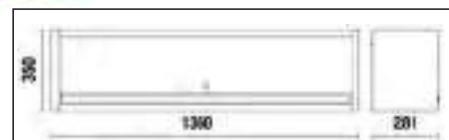

C45PRO PML

€ 445,00 1 045000303

C45PRO AS1

armário para ferramentas em chapa metálica com uma porta, a combinar com mobiliário de oficina C45PRO

- 4 prateleiras amovíveis com regulação vertical
- varão para vestuário sob a primeira prateleira
- com fechadura
- dimensões interiores 590x430 mm
- com pés com regulação vertical

📦 57,5 kg

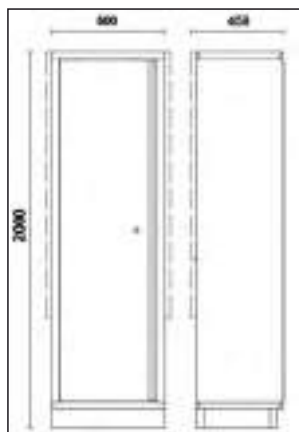

C45PRO AS1

€ 885,00 1 045000451

C45PRO A1/R600

prateleira interior para armário C45PRO AS1

📦 2,5 kg

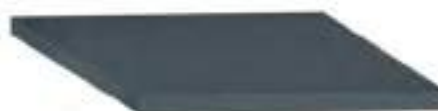

C45PRO A1/R600

€ 54,00 1 045000466

C45PRO A1/RB600

prateleira interior para armário C45PRO AS1, com varão para vestuário

📦 2,6 kg



C45PRO A1/RB600

€ 62,00 1 045000467

C45PRO AS2

armário para ferramentas em chapa metálica com duas portas, a combinar com mobiliário para oficina C45PRO

- 4 prateleiras amovíveis com regulação vertical
- Com fechadura
- Dimensões interiores 910x430 mm
- Com pés com regulação vertical

📦 80 kg



C45PRO AS2

€ 1.180,00 1 045000481

C45PRO A2/R915

📦 3,7 kg

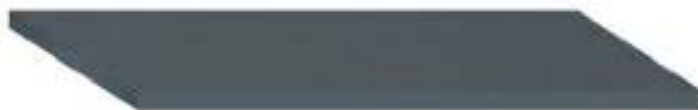

C45PROA2/R915

€ 67,00 1 045000496

C45STR







fita adesiva colorida para combinar com equipamento para oficina C45PRO

- permite a personalização da cor das inserções horizontais e verticais no equipamento para oficina C45PRO

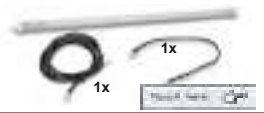
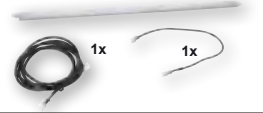

	L m	€	📦	📄
C45STR-O/2011	30	69,50	1	045000911
C45STR-G/9006	25	63,00	1	045000912
C45STR-R/3000	25	63,00	1	045000913
C45STR-B/5015	25	63,00	1	045000914
C45STR-Y/1023	25	63,00	1	045000915
C45STR-V/6029	25	63,00	1	045000916

ACESSÓRIOS RSC55 - RSC50 - C45PRO

		5000 RSC50/PLED-ST	5000 RSC50/PLED	5000 RSC50/ASL	5000 RSC50/CTR
					
	A	1x	-	1x	-
	B	-	1x	1x	1x
	A	1x	1x	1x	-
	B	-	2x	1x	1x
	A	1x	2x	1x	-
	B	-	3x	1x	1x

5000 RSC50/PLED

perfil termoplástico com fita LED para combinar com mobiliário de oficina RSC50

Para aplicar sob bancadas, sob/em armários suspensos, sob prateleiras e resguardos lineares/de canto, para iluminar áreas de trabalho.

Características:

- Fita LED 6.5W IP20; comprimento: 50 cm
- Fornecido com 2 cabos (40cm e 170cm comp. respetivamente)
- Fixação fácil através de ímanes



80 g

5000 RSC50/PLED

€ 39,50 1 050001714

5000 RSC50/PLED-ST

perfil em alumínio com fita LED e interruptor SOFT TOUCH, para combinar com mobiliário de oficina RSC50

Para aplicar sob bancadas, sob/em armários suspensos, sob prateleiras e resguardos lineares/de canto, para iluminar áreas de trabalho.

Características:

- Fita LED 6.5W IP20; comprimento: 50 cm
- Interruptor SOFT TOUCH para ligar e ajustar a potência de iluminação
- Fornecido com 2 cabos (40cm e 170cm comp. respetivamente)
- Fixação fácil através de ímanes



80 g

5000 RSC50/PLED-ST

€ 43,50 1 050001715

5000 RSC50/ASL

fonte de alimentação para faixa LED para combinar com mobiliário de oficina RSC50

Características:

- Fonte de alimentação 24VDC 22W 15W IP20
- Pode fornecer uma potência a faixas LED até 3 6.5W

200 g



5000 RSC50/ASL

€ 34,00 1 050001716

5000 RSC50/CTR

controlador de fita LED, com controlo remoto RF para combinar com mobiliário de oficina RSC50

Apenas para utilização com fita LED artigo 5000 RSC50/PLED

Kit inclui:
1 mini recetor
1 controlo remoto RF sem fio

Especificações do mini recetor:
Voltagem de entrada: 5V -24VDC
Corrente nominal de saída: 5A
Pico corrente de saída: 12A
Temperatura de funcionamento: -20 ÷ +35 °C

Especificações do controlo remoto RF:
Botão ON/OFF
Botão LUMINOSIDADE +/- : permite o ajuste manual da luminosidade
Botão 25%/50%/100%: permite o ajuste automático da luminosidade
Bateria: 3V CR2025 (incluída)
Dimensões: 86x40x7 mm

Recursos integrados:

- Memória
- Modo (luminosidade manual/automática)
- Ajuste da luminosidade



20 g

5000 RSC50/CTR € 17,10 1 050001721

CPMB/3C

recipientes para peças pequenas com 3 gavetas para bancadas de trabalho

- Estrutura externa em PP
- Gavetas para peças pequenas em PET
- Empilháveis

Especificações das gavetas:
• Dimensões do interior da gaveta: 160x107x105h mm
• Inquebrável
• Transparência de efeito vidro inalterada ao longo do tempo
• Antirriscos
• Resistente a óleo, ácidos e produtos químicos agressivos
• Também adequado para utilização em produtos alimentares



2 kg

CPMB/3C € 58,50 1 088880443

KIT 6VC/3C

kit de 6 gavetas amovíveis para recipientes para peças pequenas CPMB/3C

1,1 kg



6x



KIT 6VC/3C € 32,00 1 088880453

CPMB/5C

recipientes para peças pequenas com 5 gavetas para bancadas de trabalho

- Estrutura externa em PP
- Gavetas para peças pequenas em PET
- Empilháveis

Especificações das gavetas:

- Dimensões do interior da gaveta: 90x86x62h mm
- Inquebrável
- Transparência de efeito vidro inalterada ao longo do tempo
- Antirriscos
- Resistente a óleo, ácidos e produtos químicos agressivos
- Também adequado para utilização em produtos alimentares

1,5 kg

CPMB/5C

€ 70,00 1 088880445



KIT 10VC/5C

kit de 10 gavetas amovíveis para recipientes para peças pequenas CPMB/5C

800 g

KIT 10VC/5C

€ 30,00 1 088880455



10x



PM/5C

recipientes para peças pequenas com 5 gavetas em plástico, com suporte

- dimensões do interior da gaveta: 95x120 mm
- podem ser utilizados com os painéis de ferramentas de parede C45PRO e RSC55

1,8 kg

PM/5C

€ 123,00 1 088880450



PM/6C

recipientes para peças pequenas com 6 gavetas em plástico, com suporte

- dimensões do interior da gaveta: 80x60 mm
- podem ser utilizados com os painéis de ferramentas de parede C45PRO e RSC55

970 g

PM/6C

€ 94,50 1 088880440



CP

Suporte de parede em aço para sprays

- Pode ser utilizado em painéis de ferramentas de parede

530 g

CP

€ 119,00 1 088880470



SPC

suporte para computador

- Compatível com os sistemas RSC55 e C45PRO
- Dimensões 398x243x138 mm

1,5 kg



SPC

€ 96,00 1 088880480

SP5S

suporte de parede com 5 compartimentos

- Em chapa metálica
- 5 compartimentos de ferramentas variáveis em altura
- Dimensões: 260x60x290 mm

1 kg



SP5S

€ 119,00 1 088880475



CARROS

FERRAMENTAS SORTIDAS

MÓDULOS

sem suportes

com suportes

módulos soft específicos

tabuleiros maleáveis

		Nr. peças	RSC22	RSC23	RSC23C	RSC23T	RSC24/5	RSC24/6	RSC24/7	RSC24A/7	RSC24/8	RSC24A/8	RSC24AXL/9	C25	C27S	RSC28	C30M	
FERRAMENTAS SORTIDAS	5902MT	Máquinas de movimentação de terras	106	☐ 518	☐ 518	☐ 518												
	5902MT/AS	Máquinas de movimentação de terras	99	☐ 519	☐ 519	☐ 519												
	5902VI	Para a manutenção industrial	107	☐ 481	☐ 481		☐ 481							☐ 481	☐ 481			
	5904VG/3	Automóvel	132					☐ 522	☐ 522	☐ 522	☐ 522							
	5905VG/1	Automóvel	94											☐ 525				
	5905VG/2	Automóvel	118											☐ 526				
	5910VI/3	Para a manutenção industrial	297														☐ 485	
	5954VG	Automóvel	138															
	5954VI	Para a manutenção industrial	133															
	5957U-P	Utilização universal	133															
	5957VG	Automóvel	174															
	5957VI	Para a manutenção industrial	162															
	5958U	Utilização universal	85															
	MÓDULOS	5904VG/2M	Automóvel	170				☐ 520	☐ 520	☐ 520	☐ 520	☐ 520	☐ 520	☐ 520				☐ 520
5904VU/1M		Utilização universal	90				☐ 490	☐ 490	☐ 490	☐ 490	☐ 490	☐ 490	☐ 490				☐ 490	
5904VU/2M		Utilização universal	144				☐ 491	☐ 491	☐ 491	☐ 491	☐ 491	☐ 491	☐ 491				☐ 491	
5927VU/M		Utilização universal	108	☐ 501	☐ 501	☐ 501									☐ 501			
5935ET/1MB		Electrotechnical	96															
5935VG/1MB		Automóvel	98															
5935VI/2MB		Para a manutenção industrial	133															
5945VUM		Utilização universal	231															
5988H/7M		Automóvel	333								☐ 508	☐ 508					☐ 508	
5988L/4M		Automóvel	273					☐ 509	☐ 509	☐ 509	☐ 509	☐ 509	☐ 509					
5980U/BIKE-M		Reparação de bicicletas	106									☐ 507	☐ 507				☐ 507	
5988U6/M		Utilização universal	214							☐ 510	☐ 510	☐ 510	☐ 510				☐ 510	
5988U/7M		Utilização universal	215				☐ 497	☐ 497	☐ 497	☐ 497	☐ 497	☐ 497	☐ 497				☐ 497	
5988VHB-MQ		Electrotechnical	66				☐ 514	☐ 514	☐ 514	☐ 514	☐ 514	☐ 514	☐ 514				☐ 514	
5989 VEM		Automóvel	66				☐ 517	☐ 517	☐ 517	☐ 517	☐ 517	☐ 517	☐ 517				☐ 517	
MÓDULOS		5904VI/1T	Para a manutenção industrial	98				☐ 481	☐ 481	☐ 481	☐ 481	☐ 481	☐ 481					☐ 481
		5904VI/2T	Para a manutenção industrial	153				☐ 482			☐ 482	☐ 482	☐ 482					☐ 482
		5904VI/3T	Para a manutenção industrial	142								☐ 483	☐ 483					☐ 483
		5904VG/2T	Automóvel	99				☐ 521	☐ 521	☐ 521	☐ 521	☐ 521	☐ 521					☐ 521
		5904VG/3T	Automóvel	102				☐ 523	☐ 523	☐ 523	☐ 523	☐ 523	☐ 523					☐ 523
	5904VG/5T	Automóvel	153				☐ 524		☐ 524	☐ 524	☐ 524	☐ 524					☐ 524	
	5904VU/2T	Utilização universal	104				☐ 492	☐ 492	☐ 492	☐ 492	☐ 492	☐ 492	☐ 492				☐ 492	
	5904VU/3T	Utilização universal	146				☐ 493	☐ 493	☐ 493	☐ 493	☐ 493	☐ 493	☐ 493				☐ 493	
	5904VU/4T	Utilização universal	197				☐ 494	☐ 494	☐ 494	☐ 494	☐ 494	☐ 494	☐ 494					
	5908VG/2T	Automóvel	214															☐ 527
	5908VI/2T	Para a manutenção industrial	232								☐ 484	☐ 484					☐ 484	
	5908VU/2T	Utilização universal	161				☐ 495		☐ 495	☐ 495	☐ 495	☐ 495	☐ 495				☐ 495	
	5910VI/3T	Para a manutenção industrial	261															☐ 486
	5938U/2T	Utilização universal	210															

CARROS

FERRAMENTAS SORTIDAS

MÓDULOS

		Nr. peças	C35	C38	C39MD C39SM	C39T	C45PRO	RSC51	C54S RSC55C	RSC55	RSC55PS RSC55PSE	RSC50	C57SA C57SB C57SP		C58P C45PRO PAS	C59A C59C	C59B
													C57SA	C57SB			
sem suportes	5902MT	Máquinas de movimentação de terras	106			▢ 518											
	5902MT/AS	Máquinas de movimentação de terras	99			▢ 519											
	5902VI	Para a manutenção industrial	107														
	5904VG/3	Automóvel	132							▢ 522		▢ 522				▢ 522	▢ 522
	5905VG/1	Automóvel	94														
	5905VG/2	Automóvel	118														
	5910VI/3	Para a manutenção industrial	297														
	5954VG	Automóvel	138						▢ 531								
	5954VI	Para a manutenção industrial	133						▢ 489	▢ 489							
	5957U-P	Utilização universal	133									▢ 503	▢ 503	▢ 503			
	5957VG	Automóvel	174									▢ 532		▢ 532			
	5957VI	Para a manutenção industrial	162											▢ 488			
5958U	Utilização universal	85				▢ 504			▢ 504	▢ 504				▢ 504			
módulos soft específicos	5904VG/2M	Automóvel	170		▢ 520	▢ 520				▢ 520						▢ 520	▢ 520
	5904VU/1M	Utilização universal	90		▢ 490	▢ 490		▢ 490		▢ 490						▢ 490	▢ 490
	5904VU/2M	Utilização universal	144		▢ 491	▢ 491				▢ 491						▢ 491	▢ 491
	5927VU/M	Utilização universal	108														
	5935ET/1MB	Electrotechnical	96	▢ 511													
	5935VG/1MB	Automóvel	98	▢ 528													
	5935VI/2MB	Para a manutenção industrial	133	▢ 487													
	5945VUM	Utilização universal	231		▢ 530		▢ 530										
	5988H/7M	Automóvel	333								▢ 508						▢ 469
	5988L/4M	Automóvel	273		▢ 470	▢ 470					▢ 470					▢ 470	▢ 470
	5980U/BIKE-M	Reparação de bicicletas	106														
	5988U6/M	Utilização universal	214		▢ 510						▢ 510						▢ 510
	5988U/7M	Utilização universal	215		▢ 497						▢ 497					▢ 497	▢ 497
	5988VHB-MQ	Electrotechnical	66		▢ 514	▢ 514		▢ 514		▢ 514						▢ 514	▢ 514
	5989 VEM	Automóvel	66														
tabuleiros maleáveis	5904VI/1T	Para a manutenção industrial	98		▢ 481	▢ 481		▢ 481		▢ 481						▢ 481	▢ 481
	5904VI/2T	Para a manutenção industrial	153		▢ 482					▢ 482						▢ 482	▢ 482
	5904VI/3T	Para a manutenção industrial	142		▢ 483					▢ 483							▢ 483
	5904VG/2T	Automóvel	99		▢ 521	▢ 521		▢ 521		▢ 521						▢ 521	▢ 521
	5904VG/3T	Automóvel	102		▢ 523	▢ 523				▢ 523						▢ 523	▢ 523
	5904VG/5T	Automóvel	153		▢ 524					▢ 524						▢ 524	▢ 524
	5904VU/2T	Utilização universal	104		▢ 492	▢ 492				▢ 492						▢ 492	▢ 492
	5904VU/3T	Utilização universal	146		▢ 493	▢ 493				▢ 493						▢ 493	▢ 493
	5904VU/4T	Utilização universal	197		▢ 494	▢ 494				▢ 494						▢ 494	▢ 494
	5908VG/2T	Automóvel	214														
	5908VI/2T	Para a manutenção industrial	232														▢ 484
	5908VU/2T	Utilização universal	161		▢ 495					▢ 495						▢ 495	▢ 495
	5910VI/3T	Para a manutenção industrial	261														
	5938U/2T	Utilização universal	210		▢ 502												

5902VI

jogo de 107 ferramentas

► Manutenção industrial

Nr. Peças/Descrição

Nr. Peças/Descrição	Refa. Nr.
6 saca-troços Ø 2 - 3 - 4 - 5 - 6 - 8 mm	31
1 punção de bico Ø 3 mm	32
1 escopros planos 200 mm	35
26 chaves mistas 6÷32 mm	42/S26
12 chaves de bocas 6x7 - 8x9 - 10x11 - 12x13 - 14x15 - 16x17 - 18x19 - 20x22 - 21x23 - 24x26 - 25x28 - 30x32 mm	55/S12
9 chaves macho hexagonal Ø 1,5 - 2 - 2,5 - 3 - 4 - 5 - 6 - 8 - 10 mm	96N/SC9
1 Chave ajustável 300 mm	111E
13 chaves de caixa sextavadas, quadra de 1/2" Ø 10÷22 mm	920A/SB13
1 extensão com quadras macho e fêmea de 1/2" 125 mm	920/21
1 extensão com quadras macho e fêmea de 1/2" 255 mm	920/22
1 cardan com quadras macho e fêmea de 1/2"	920/25
1 cabo T correção, quadra de 1/2"	920/42
1 roquete reversível, quadra de 1/2" Ⓞ	920/55
1 alicate de charneira fechada 250 mm	1048N
1 alicate de pressão 240 mm	1052
1 alicates de corte diagonal para serviços pesados, punhos em bi-matéria, acabamento industrial 160 mm	1084GBM
1 tesoura articulada, lâminas direitas 250 mm	1122
1 tesoura de electricista	1128BMX
1 alicate combinado para trabalhos pesados, punhos bi-material, acabamento industrial = 180 mm	1150GBM
1 alicate de pontas semi-redondas com estrias, extra-longas, punhos bi-material, acabamento industrial ● 160 mm	1166GBM
8 chaves para parafusos de perfil de fenda ● 2,5x50 - 3x75 - 3,5x100 - 4x125 - 5,5x125 - 6,5x150 - 8x200 - 10x200 mm	1260
4 chaves para parafusos de perfil Phillips® ● PH0x60 - PH1x80 - PH2x100 - PH3x150 mm	1262
1 martelo para mecânico, tipo alemão 500 g	1370
1 martelo anti - recuo com batentes plásticos intermutáveis Ø 40 mm	1392
1 riscador, extremidades em carboneto de tungstênio	1688A
1 fita métrica 5 m	1692
1 apalpa - folgas	1708/20
5 jogo de 5 limas meia-murça, com punhos 200 mm	1719BMA...S5
1 serrote com folha de serra bi-metálica	1726BM
1 Lata de óleo de pressão 300 cc	1751N
1 x - acto com lâmina divisível de 18 mm	1771BM
1 lâmpada magnética articulada com LEDs de alta luminosidade, em alumínio anodizado robusto, até 500 lúmens	1837F

5902VI

€ 1.900,00 059021060

Sortido recomendado em combinação com RSC22 - RSC23 - RSC23T - C25 - C27S

5904VI/1T

jogo de 98 ferramentas

► Manutenção industrial

Nr. Peças/Descrição

Nr. Peças/Descrição	Refa. Nr.	TR
19 chaves de caixa sextavadas, quadra de 1/2" Ø 10÷24 - 26 - 27 - 30 - 32 mm	920A	T80
5 chaves de caixa com ponta hexagonal, quadra de 1/2" Ø 5 - 6 - 8 - 10 - 12 mm	920ME	T80
1 extensão com quadras macho e fêmea de 1/2" 125 mm	920/21	T80
1 extensão com quadras macho e fêmea de 1/2" 255 mm	920/22	T80
1 cardan com quadras macho e fêmea de 1/2"	920/25	T80
1 cabo T correção, quadra de 1/2"	920/42	T80
1 roquete reversível, quadra de 1/2" Ⓞ	920/55	T80
16 chaves mistas, boca-luneta 6÷21 mm	42	T05
5 chaves mistas, boca-luneta 22-24-27-30-32 mm	42	T06
1 alicate de charneira fechada 250 mm	1048N	T153
1 alicate de pressão 240 mm	1052	T153
1 Alicates de corte diagonal para trabalhos pesados 160 mm	1084	T138
1 alicate de pontas semi-redondas extra-longas = 180 mm	1150	T138
1 Alicates de pontas semirredondas extralongas ● 160 mm	1166	T138
1 alicates de freios interiores com pontas direitas ○ 180 mm	1032	T145
1 alicates de freios interiores com pontas curvas ○ 170 mm	1034	T145
1 alicates de freios exteriores com pontas direitas ● 175 mm	1036	T145
1 alicates de freios exteriores com pontas curvas ● 175 mm	1038	T145
2 escopros planos 100 - 200 mm	35	T234
5 limas perfis diversos 200 mm	1719BMA8/S5	T236
1 martelo para mecânico, tipo alemão 300 g	1370	T234
1 martelo com batentes plásticos intermutáveis Ø 35 mm	1390	T234
8 chaves de bocas 6x7 - 8x9 - 10x11 - 12x13 - 14x15 - 16x17 - 18x19 - 20x22 mm	55	T33
9 chaves macho hexagonal Ø 1,5 - 2 - 2,5 - 3 - 4 - 5 - 6 - 8 - 10 mm	96/SC9	T33
4 chaves para parafusos de perfil de fenda ● 3x75 - 4x100 - 5,5x150 - 6,5x150 mm	1260	T208
3 chaves para parafusos de perfil Phillips® ● PH0x60 - PH1x80 - PH2x100 mm	1262	T208
6 chaves em T com três extremidades macho hexagonal 2,5 - 3 - 4 - 5 - 6 - 8 mm	951	T68

5904VI/1T

€ 1.720,00 059041161

Sortido recomendado em combinação com RSC51 - RSC23T - RSC24 - RSC24L/7 - RSC24L-CAB
RSC24A - RSC24AXL - RSC28 - C37 - C39 com 6 - 7 - 8 gavetas - C39MD - C39SM - C39T - RSC55 - C59

5904VI/2T

jogo de 153 ferramentas em módulo rígido

► Manutenção industrial

Nr. Peças/Descrição

Refa. Nr. TR



T05 T06 T31



T40 T83 T91



T167 T168



T153 T138 T145 T68



T236 T234 T281 T294

- 16 chaves mistas, boca-luneta 6÷21 mm 42 T05
- 5 chaves mistas, boca-luneta 22 - 24 - 27 - 30 - 32 mm 42 T06
- 5 saca-troços Ø 2 - 3 - 4 - 5 - 6 mm 31 T31
- 1 punção de bico Ø 4 mm 32 T31
- 12 chaves de bocas 6x7 - 8x9 - 10x11 - 12x13 - 14x15 - 16x17 - 18x19 - 20x22 - 21x23 - 24x26 - 27x29 - 30x32 mm 55 T31
- 9 chaves macho hexagonal Ø 1,5 - 2 - 2,5 - 3 - 4 - 5 - 6 - 8 - 10 mm 96N/SC9 T31
- 7 chaves de luneta curvatura profunda 6÷29 mm 90 T40
- 19 chaves de caixa sextavadas, quadra de 1/2" Ø 10÷24 - 26 - 27 - 30 - 32 mm 920A T83
- 1 extensão com quadras macho e fêmea de 1/2" 125 mm 920/21 T83
- 1 extensão com quadras macho e fêmea de 1/2" 255 mm 920/22 T83
- 1 cardan com quadras macho e fêmea de 1/2" 920/25 T83
- 1 cabo T correção, quadra de 1/2" 920/42 T83
- 1 roquete reversível, quadra de 1/2" 920/55 T83
- 13 chaves de caixa sextavadas, quadra de 1/4" Ø 4÷14 mm 900 T91
- 6 chaves de caixa com ponta sextavadas, quadra de 1/4" Ø 2,5÷8 mm 900ME T91
- 1 extensão, quadra 1/4" 50 mm 900/20 T91
- 1 extensão, quadra 1/4" 150 mm 900/21 T91
- 1 cardan com quadras macho e fêmea de 1/4" 900/25 T91
- 1 extensão com punho, quadra macho de 1/4" 900BG/30 T91
- 1 cabo T correção, quadra de 1/4" 900/42 T91
- 1 roquete reversível, quadra de 1/4" 900/55 T91
- 9 chaves para parafusos de perfil de fenda 3x75 - 3x100 - 4x100 - 4x150 - 5,5x100 - 5,5x150 - 6,5x150 - 8x150 - 10x200 mm 1260 T167
- 2 chave para parafusos de perfil de fenda série curta 4x30 - 6,5x30 mm 1260N T167
- 7 chaves para parafusos de perfil Phillips® PH0x60 - PH0x100 - PH1x80 - PH1x120 - PH2x100 - PH2x150 - PH3x150 mm 1262 T168
- 2 chaves para parafusos de perfil Phillips® série curta PH1x30 - PH2x30 mm 1262N T168
- 1 alicate de charneira fechada 250 mm 1048N T153
- 1 alicate de pressão 240 mm 1052 T153
- 1 Alicates de corte diagonal para trabalhos pesados 160 mm 1084 T138
- 1 Alicates de pontas semirredondas extralongas 160 mm 1166 T138
- 1 alicate de pontas semi-redondas extra-longas 180 mm 1150 T138
- 1 alicates de freios interiores com pontas direitas 180 mm 1032 T145
- 1 alicates de freios interiores com pontas curvas 170 mm 1034 T145
- 1 alicates de freios exteriores com pontas direitas 175 mm 1036 T145
- 1 alicates de freios exteriores com pontas curvas 175 mm 1038 T145
- 6 chaves em T com três extremidades macho hexagonal 2,5 - 3 - 4 - 5 - 6 - 8 mm 951 T68
- 5 limas perfis diversos 200 mm 1719BMA8/S5 T236
- 2 escopros planos 100 - 200 mm 35 T234
- 1 martelo para mecânico, tipo alemão 300 g 1370 T234
- 1 martelo com batentes plásticos intermutáveis Ø 35 mm 1390 T234
- 1 alicate de rebitar 1741B T281
- 100 rebites em alumínio 2,9x6 mm 1741RV...K T281
- 100 rebites em alumínio 3,2x8 mm 1741RV...K T281
- 100 rebites em alumínio 3,8x10 mm 1741RV...K T281
- 100 rebites em alumínio 4x12 mm 1741RV...K T281
- 100 rebites em alumínio 4,8x12 mm 1741RV...K T281
- 1 fita métrica 1692 T294
- 1 mini serrote 1725CR T294
- 1 10 lâminas divisível de 18 mm para x-acto refª. 1771, 1771BM, 1771HD 1771RL T294
- 1 x - acto com lâmina divisível de 18 mm 1771 T294

€

5904VI/2T

2.440,00 059041164

Sortido recomendado em combinação com RSC23T - RSC24 com 7 - 8 gavetas - RSC24A com 7 - 8 gavetas - RSC24AXL - RSC24L/7 - RSC24L-CAB - RSC28 - C37 com 7 - 8 gavetas - C39 com 7 - 8 gavetas - C39MD - C39SM - C59 - RSC50 - RSC55

5904VI/3T

jogo de 142 ferramentas em módulo rígido

► Manutenção industrial

Nr. Peças/Descrição

Refa. Nr. TR



T05 T06 T31



T167 T202 T205



T80 T73 T68



T137 T153 T145 T146



T231 T297 T281



T279 VP6

- 16 chaves mistas, boca-luneta 6+21 mm
- 5 chaves mistas, boca-luneta 22 - 24 - 27 - 30 - 32 mm
- 5 saca-troços Ø 2 - 3 - 4 - 5 - 6 mm
- 1 punção de bico Ø 4 mm
- 12 chaves de bocas 6x7 - 8x9 - 10x11 - 12x13 - 14x15 - 16x17 - 18x19 - 20x22 - 21x23 - 24x26 - 27x29 - 30x32 mm
- 9 chaves macho hexagonal ○ 1,5 - 2 - 2,5 - 3 - 4 - 5 - 6 - 8 - 10 mm
- 9 chaves para parafusos de perfil de fenda ● 3x75 - 3,5x100 - 4x100 - 4x150 - 5,5x100 - 5,5x150 - 6,5x150 - 8x150 - 10x200 mm
- 2 chave para parafusos de perfil de fenda série curta ● 4x30 - 6,5x30 mm
- 6 chaves para parafusos de perfil Phillips® ⚙ PH0x60 - PH0x100 - PH1x80 - PH1x120 - PH2x100 - PH2x150 mm
- 7 chaves para parafusos de perfil Torx® ⚙ T6-T7-T8-T9-T10-T15-T20
- 5 chaves de caixa com ponta hexagonal, quadra de 1/2" ○ 5 - 6 - 8 - 10 - 12 mm
- 1 extensão com quadras macho e fêmea de 1/2" 125 mm
- 1 extensão com quadras macho e fêmea de 1/2" 255 mm
- 1 cardan com quadras macho e fêmea de 1/2"
- 1 cabo T corrediço, quadra de 1/2"
- 1 roquete reversível, quadra de 1/2" ⚙
- 19 chaves de caixa sextavadas, quadra de 1/2" ○ 10+24 - 26 - 27 - 30 - 32 mm
- 8 chaves tubulares de bisetavadas 6x7 - 8x9 - 10x11 - 12x13 - 14x15 - 16x17 - 18x19 - 20x22 mm
- 1 passadores para chaves tubulares
- 1 passadores para chaves tubulares
- 6 chaves em T com três extremidades macho hexagonal 2,5 - 3 - 4 - 5 - 6 - 8 mm
- 1 alicate de pontas semi-redondas extra-longas = 180 mm
- 1 Alicates de pontas semi-redondas extralongas ● 160 mm
- 1 Alicates de corte diagonal para trabalhos pesados ⚔ 160 mm
- 1 alicate de charneira fechada 250 mm
- 1 alicate de pressão 240 mm
- 1 alicates de freios interiores com pontas direitas ○ 180 mm
- 1 alicates de freios interiores com pontas curvas ○ 170 mm
- 1 alicates de freios exteriores com pontas direitas ● 175 mm
- 1 alicates de freios exteriores com pontas curvas ● 175 mm
- 1 alicates de freios interiores com pontas direitas ○ 140 mm
- 1 alicates de freios interiores com pontas curvas ○ 225 mm
- 1 alicates de freios exteriores com pontas direitas ● 140 mm
- 1 alicates de freios exteriores com pontas curvas ● 225 mm
- 1 martelo para mecânico, tipo alemão 400 g
- 1 martelo com batentes plásticos intermutáveis Ø 35 mm
- 1 limas perfis diversos 200 mm
- 1 limas perfis diversos 200 mm
- 1 limas perfis diversos 200 mm
- 1 limas perfis diversos 200 mm
- 1 régua graduadas flexíveis em aço inoxidável 300 mm
- 1 5 m
- 1 alicate de rebitar 250 mm
- 100 rebites em alumínio 2,9x6 mm
- 100 rebites em alumínio 3,2x8 mm
- 100 rebites em alumínio 3,8x10 mm
- 100 rebites em alumínio 4x12 mm
- 100 rebites em alumínio 4,8x12 mm
- 1 tesoura modelo americano 250 mm
- 1 tesoura de electricista
- 1 serrote com folha de serra bi-metálica
- (5) folhas de serra (HSS bi-metálicas)
- 1 Lata de óleo de pressão 200 cc
- módulo

42	T05
42	T06
31	T31
32	T31
55	T31
96N/SC9	T31
1260	T167
1260N	T167
1262	T202
1267TX	T205
920ME	T80
920/21	T80
920/22	T80
920/25	T80
920/42	T80
920/55	T80
920A	T80
930	T73
940/1	T73
940/2	T73
951	T68
1150BM	T137
1166BM	T137
1084BM	T137
1048N	T153
1052	T153
1032	T145
1034	T145
1036	T145
1038	T145
1032	T146
1034	T146
1036	T146
1038	T146
1370	T231
1390	T231
1719BMA8/T	T231
1719BMA8/P	T231
1719BMA8/M	T231
1651DGTB	T297
1682	T297
1691BM	T297
1741B	T281
1741RV..K	T281
1741RV..K	T281
1741RV..K	T281
1741RV..K	T281
1741RV..K	T281
1112	T279
1128BM	T279
1726	T279
1728BM	T279
1751N	T279
VP6	VP6

5904VI/3T € 2.800,00 059041168

Sortido recomendado em combinação com RSC24 com 8 gavetas - RSC24A com 8 gavetas - RSC24AXL com 8 gavetas - RSC28 - C37 com 8 gavetas - C39 com 8 gavetas - C39MD - C39SM - RSC50 - RSC55 - C59B

5908VI/2T

jogo de 232 ferramentas

► Manutenção industrial

Nr. Peças/Descrição

Refa. Nr. TR



T89 T65 T06



T91 T68 T40 T41



T199 T202 T201 T204



T234 T281 T153 T236



T145 T137 T31



T279 VP5



T273 T270

- 5 chaves de caixa com ponta hexagonal, quadra de 1/2" \odot 5 - 6 - 8 - 10 - 12 mm
- 1 extensão com quadras macho e fêmea de 1/2" 125 mm
- 1 extensão com quadras macho e fêmea de 1/2" 255 mm
- 1 cardan com quadras macho e fêmea de 1/2"
- 1 cabo T corredeço, quadra de 1/2"
- 1 roquete reversível, quadra de 1/2" \otimes
- 19 chaves de caixa sextavadas, quadra de 1/2" \odot 10÷24 - 26 - 27 - 30 - 32 mm
- 16 chaves mistas, boca-luneta 6÷21 mm
- 5 chaves mistas, boca-luneta 22 - 24 - 27 - 30 - 32 mm
- 13 chaves de caixa sextavadas, quadra de 1/4" \odot 4÷14 mm
- 6 chaves de caixa com ponta sextavadas, quadra de 1/4" \odot 2,5 - 3 - 4 - 5 - 6 - 8 mm
- 1 extensão, quadra 1/4" 50 mm
- 1 extensão, quadra 1/4" 150 mm
- 1 extensão com punho, quadra macho de 1/4"
- 1 cardan com quadras macho e fêmea de 1/4"
- 1 cabo T corredeço, quadra de 1/4"
- 1 roquete reversível, quadra de 1/4" \otimes
- 6 chaves em T com três extremidades macho hexagonal 2,5 - 3 - 4 - 5 - 6 - 8 mm
- 7 chaves de luneta curvatura profunda 6x7-8x9-10x11-12x13-14x15-16x17-18x19 mm
- 5 chaves de luneta curvatura profunda 20x22 - 21x23 - 24x26 - 25x28 - 27x29 mm
- 7 chaves para parafusos de perfil de fenda \bullet 2,5x50 - 3x75 - 3,5x100 - 4x125 - 5,5x100 - 5,5x150 - 6,5x150 mm
- 6 chaves para parafusos de perfil Phillips* \oplus PH0x60 - PH0x100 - PH1x80 - PH1x120 - PH2x100 - PH2x150 mm
- 3 chaves para parafusos de perfil de fenda \bullet 8x200 - 10x150 - 10x200 mm
- 2 chave para parafusos de perfil de fenda série curta \bullet 4x30 - 6,5x30 mm
- 2 chaves para parafusos de perfil Phillips* \oplus PH3x150 - PH4x200 mm
- 2 chaves para parafusos de perfil Phillips* série curta \oplus PH1x30 - PH2x30 mm
- 2 escopros planos 100 - 200 mm
- 1 martelo para mecânico, tipo alemão 300 g
- 1 martelo com batentes plásticos intermutáveis \varnothing 35 mm
- 1 alicate de rebitar 250 mm
- 100 rebites em alumínio 2,9x6 mm
- 100 rebites em alumínio 3,2x8 mm
- 100 rebites em alumínio 3,8x10 mm
- 100 rebites em alumínio 4x12 mm
- 100 rebites em alumínio 4,8x12 mm
- 1 alicate de charmeira fechada 250 mm
- 1 alicate de pressão 240 mm
- 5 jogo de 5 limas meia-murça, com punhos 200 mm
- 1 alicates de freios interiores com pontas direitas \odot 180 mm
- 1 alicates de freios interiores com pontas curvas \odot 170 mm
- 1 alicates de freios exteriores com pontas direitas \bullet 175 mm
- 1 alicates de freios exteriores com pontas curvas \bullet 175 mm
- 1 alicate de pontas semi-redondas extra-longas \equiv 180 mm
- 1 Alicates de pontas semi-redondas extralongas \bullet 160 mm
- 1 Alicates de corte diagonal para trabalhos pesados \blacktriangleleft 160 mm
- 5 saca-troços \varnothing 2 - 3 - 4 - 5 - 6 mm
- 1 punção de bico \varnothing 4 mm
- 12 chaves de bocas 6x7 - 8x9 - 10x11 - 12x13 - 14x15 - 16x17 - 18x19 - 20x22 - 21x23 - 24x26 - 27x29 - 30x32 mm
- 9 chaves macho hexagonal \odot 1,5 - 2 - 2,5 - 3 - 4 - 5 - 6 - 8 - 10 mm
- 1 tesoura modelo americano 250 mm
- 1 tesoura de electricista
- 1 serrote com folha de serra bi-metálica
- 5 folhas de serra (HSS bi-metálicas)
- 1 Lata de óleo de pressão 200 cc
- 1 módulo
- 1 desandador de machos extensível M3÷M12
- 1 desandador de machos extensível M5÷M21
- 1 punho desandador de machos com roquete reversível 2,0÷5,0 mm (M3÷M8)
- 1 punho desandador de machos com roquete reversível 4,6÷8,0 mm (M5÷M12)
- 1 porta - caçonetos 25,4 mm
- 1 porta - caçonetos 38,1 mm
- 1 conta - fios 0,25÷6 W 62÷4x1"
- 26 machos manuais, passo largo M3 - 4 - 5 - 6 - 7 - 8 - 9 - 10 - 12 - 14 - 16 - 18 - 20
- 14 machos manuais, passo fino M6x0,75 - M8x1 - M10x1,25 - M12x1,5 - M14x1,5 - M16x1,5 - M18x1,5
- 7 caçonetos redondos, passo largo M3 - 4 - 5 - 6 - 7 - 8 - 9
- 6 caçonetos redondos, passo largo M10 - 12 - 14 - 16 - 18 - 20
- 2 caçonetos redondos, passo fino M6x0,75 - M8x0,75
- 5 caçonetos redondos, passo fino M10x1,25 - M12x1,5 - M14x1,5 - M16x1,5 - M18x1,5

920ME	T80
920/21	T80
920/22	T80
920/25	T80
920/42	T80
920/55	T80
920A	T80
42	T05
42	T06
900	T91
900ME	T91
900/20	T91
900/21	T91
900BG/30	T91
900/25	T91
900/42	T91
900/55	T91
951	T68
90	T40
90	T41
1260	T199
1262	T202
1260	T201
1260N	T201
1262	T204
1262N	T204
35	T234
1370	T234
1390	T234
1741B	T281
1741RV...K	T281
1741RV...K	T281
1741RV...K	T281
1741RV...K	T281
1741RV...K	T281
1048N	T153
1052	T153
1719BMA...S5	T236
1032	T145
1034	T145
1036	T145
1038	T145
1150BM	T137
1166BM	T137
1084BM	T137
31	T31
32	T31
55	T31
96N/SC9	T31
1112	T279
1128BM	T279
1726	T279
1728BM	T279
1751N	T279
VP5	VP5
435/1,5	T273
435/3	T273
436/1	T273
436/2	T273
444/1	T273
444/2	T273
1707	T273
430	T270
433	T270
440	T270
440A	T270
441	T270
441A	T270

€

5908VI/2T

3.700,00 059081105

Sortido recomendado em combinação com RSC28 - RSC24/8 - RSC24A/8 - RSC24AXL com 8-9 gavetas - C37/8 - C39/8 - C59B



5910VI/3

Sortido de 297 ferramentas

► Manutenção industrial

Nr. Peças/Descrição	Refa. Nr.
6 Ø 2 - 3 - 4 - 5 - 6 - 8 mm	31/B6N
1 punção de bico Ø 4 mm	32
2 escopros planos 125 - 250 mm	35
1 buñil, nervurado 200 mm	37
30 chaves mistas, boca-luneta 6-7-8-9-10-11-12-13-14-15-16-17-18-19-20-21-22-23-24-25-26-27-28-29-30-32-35-36-38-41 mm	42
14 chaves de bocas 6x7 - 8x9 - 10x11 - 12x13 - 14x15 - 16x17 - 18x19 - 20x22 - 21x23 - 24x26 - 25x28 - 27x29 - 30x32 - 36x41 mm	55
13 chaves de luneta curvatura profunda 6x7+30x32 mm	90
14 chaves macho hexagonal Ø 1,5 - 2 - 2,5 - 3 - 4 - 5 - 6 - 8 - 10 - 12 - 13 - 14 - 17 - 19 mm	96N
1 Chave ajustável 250 mm	111E
1 chave para tubos, serviço pesado 300 mm	362
25 broca cilíndrica, série curta 1+13x0,5 mm	412/SP25
37 jogo de machos e caçonetos HSS, rosca métrica	447/C37
1 Chaves dinâmométricas ZERO-RESET ® 1/2", 40±200 Nm	666/20
1 extensão articulada com punho em T, quadra de 1/2"	920/40
4 chaves de caixa com ponta hexagonal, quadra de 1/2" Ø 10-12-14-17 mm	920ME
25 jogo com 20 chaves de caixa e 5 acessórios	920A/C20X
17 jogo com 12 chaves de caixa e 5 acessórios 3/4"	928A/C12
12 chaves cachimbo 6 faces 8 - 10 - 11 - 13 - 14 - 17 - 19 - 22 - 24 - 27 - 30 - 32 mm	932
14 chaves em T com três extremidades macho hexagonal 2+14 mm	951/S14
5 chaves macho hexagonal com cardan e cabo em T Ø 3 - 4 - 5 - 6 - 8 mm	953
3 alicates de freios interiores com pontas direitas Ø 180 - 225 - 300 mm	1032
3 alicates de freios interiores com pontas curvas Ø 170 - 210 - 290 mm	1034
3 alicates de freios exteriores com pontas direitas Ø 140x1,3 - 175 - 225 mm	1036
3 alicates de freios exteriores com pontas curvas Ø 135x1,3 - 175 - 220 mm	1038
2 alicate de charneira fechada 250 - 300 mm	1048N
1 alicate de pressão, regulação dupla, maxilas longas	1051
1 alicates de corte diagonal para serviços pesados, punhos em bi-matéria, acabamento industrial 160 mm	1084GBM
1 alicate de corte frontal, articulado, serviço pesado, grande esforço 180 mm	1092V
1 tesoura modelo americano 300 mm	1112
1 tesoura modelo americano com lâminas direitas e estreitas 250 mm	1114
1 tesoura de electricista	1128BMX
1 alicate combinado para trabalhos pesados, punhos bi-material, acabamento industrial 180 mm	1150GBM
1 alicate de pontas semi-redondas com estrias, extra-longas, punhos bi-material, acabamento industrial 160 mm	1166GBM
1 alicates de pontas curvas extra longas, punhos em bi-matéria, acabamento industrial 160 mm	1168GBM
9 chaves para parafusos de perfil de fenda 2,5x50 - 3x75 - 3,5x150 - 4x125 - 5,5x125 - 6,5x150 - 8x200 - 10x200 - 12x250 mm	1260
2 chave para parafusos de perfil de fenda série curta 4x30 - 6,5x30 mm	1260N
5 chaves para parafusos de perfil Phillips® PH0x100 - PH1x120 - PH2x150 - PH3x150 - PH4x200 mm	1262
2 chaves para parafusos de perfil Phillips® série curta PH1x30 - PH2x30 mm	1262N
7 chaves para parafusos de perfil Torx® T6 - T8 - T10 - T15 - T20 - T25 - T30	1267TX
2 martelo para mecânico, tipo alemão 300 - 600 g	1370
2 martelo com batentes plásticos intermutáveis Ø 35 - 60 mm	1390
5 extractores cónicos de parafusos M3+M18	1430/S5
1 extractor universal de duas pernas 23+70 mm	1500N/1
1 extractor universal de duas pernas 23+100 mm	1500N/2
1 paquímetro	1650
1 régua graduada semi-rígida 300 mm	1683
1 riscador, extremidades em carboneto de tungsténio	1688A
1 fita métrica 5 m	1692
1 apalpa - folgas	1708/13
1 pesca-peças magnético 1,8 kg	1712E/2
5 limas perfis diversos 200 mm	1719BMA8/S5
1 serrote com folha de serra bi-metálica	1726BM
1 alicate de rebitar	1741B
1 Lata de óleo de pressão 200 cc	1751N

€

5910VI/3 7.700,00 059101044

Sortido recomendado para usar com o item C30M

5910VI/3T

Sortido de 256 ferramentas em tabuleiro maleável

► Manutenção industrial

Nr. Peças/Descrição

Refa. Nr. TR



T05 T06 T31



T40 T41 T80



T167 T168 +96N



T279
T137 T145 T234 T236



- 16 chaves mistas, boca-luneta 6÷21 mm 42 T05
- 5 chaves mistas, boca-luneta 22 - 24 - 27 - 30 - 32 mm 42 T06
- 5 saca-troços Ø 2 - 3 - 4 - 5 - 6 mm 31 T31
- 1 punção de bico Ø 4 mm 32 T31
- 13 chaves de bocas 6x7 - 8x9 - 10x11 - 12x13 - 14x15 - 16x17 55 T31
- 18x19 - 20x22 - 21x23 - 24x26 - 27x29 - 30x32 mm
- 9 chaves macho hexagonal ○ 1,5 - 2 - 2,5 - 3 - 4 - 5 - 6 - 8 - 10 mm 96N/SC9 T31
- 5 chaves de luneta curvatura profunda 20x22 - 21x23 - 24x26 - 25x28 - 27x29 mm 90 T41
- 7 chaves de luneta curvatura profunda 6x7 - 8x9 - 10x11 - 12x13 - 14x15 - 16x17 90 T40
- 18x19 mm
- 5 chaves de caixa com ponta hexagonal, quadra de 1/2" ○ 5 - 6 - 8 - 10 - 12 mm 920ME T80
- 1 extensão com quadras macho e fêmea de 1/2" 125 mm 920/21 T80
- 1 extensão com quadras macho e fêmea de 1/2" 255 mm 920/22 T80
- 1 cardan com quadras macho e fêmea de 1/2" 920/25 T80
- 1 cabo T corrediço, quadra de 1/2" 920/42 T80
- 1 roquete reversível, quadra de 1/2" ⊕ 920/55 T80
- 19 chaves de caixa sextavadas, quadra de 1/2" ○ 10÷24 - 26 - 27 - 30 - 32 mm 920A T80
- 9 chaves para parafusos de perfil de fenda ● 3x75 - 3x100 - 4x100 - 4x150 - 5,5x100 - 5,5x150 1260 T167
- 6,5x150 - 8x150 - 10x200 mm
- 2 chave para parafusos de perfil de fenda série curta ● 4x30 - 6,5x30 mm 1260N T167
- 7 chaves para parafusos de perfil Phillips® ⊕ PH0x60 - PH0x100 - PH1x80 - PH1x120 - PH2x100 - PH2x150 - PH3x150 mm 1262 T168
- 2 chaves para parafusos de perfil Phillips® série curta ⊕ PH1x30 - PH2x30 mm 1262N T168
- 4 chaves macho hexagonal ○ 13-14-17-19 mm 96N T168
- 1 tesoura modelo americano 250 mm 1112 T279
- 1 tesoura de electricista 1128BM T279
- 1 serrote com folha de serra bi-metálica 1726 T279
- (5) folhas de serra (HSS bi-metálicas) 1728BM T279
- 1 Lata de óleo de pressão 200 cc 1751N T279
- 1 alicate de pontas semi-redondas extra-longas ≡ 180 mm 1150BM T137
- 1 Alicates de pontas semi-redondas extralongas ● 160 mm 1166BM T137
- 1 Alicates de corte diagonal para trabalhos pesados ⊥ 160 mm 1084BM T137
- 1 alicates de freios interiores com pontas direitas ○ 180 mm 1032 T145
- 1 alicates de freios interiores com pontas curvas ○ 170 mm 1034 T145
- 1 alicates de freios exteriores com pontas direitas ● 175mm 1036 T145
- 1 alicates de freios exteriores com pontas curvas ● 175mm 1038 T145
- 2 escopros planos 100 - 200 mm 35 T234
- 1 martelo para mecânico, tipo alemão 300 g 1370 T234
- 1 martelo com batentes plásticos intermutáveis Ø 35 mm 1390 T234
- 1 limas perfis diversos 200 mm 1719BMA8/S5 T236
- 4 chaves mistas, boca-luneta 35-36-38-41 mm 42
- 1 chaves de bocas 36x41 mm 55
- 1 Chave ajustável 250 mm 111E
- 1 chave para tubos, serviço pesado 300 mm 362
- 25 broca cilíndrica, série curta 412/SP25
- 37 jogo de machos e caçonetos HSS, rosca métrica 447/C37
- 1 Chaves dinamométricas ZERO-RESET ⊕ 40÷200 Nm 666/20
- 17 jogo com 12 chaves de caixa e 5 acessórios 3/4" 928A/C12
- 14 chaves em T com três extremidades macho hexagonal 951/S14
- 5 chaves macho hexagonal com cardan e cabo em T ○ 3-4-5-6-8 mm 953
- 1 alicates de freios interiores com pontas direitas ○ 300 mm 1032
- 1 alicates de freios interiores com pontas curvas ○ 290 mm 1034
- 1 alicates de freios exteriores com pontas direitas ● 225 mm 1036
- 1 alicates de freios exteriores com pontas curvas ● 220 mm 1038
- 1 alicate de charneira fechada 300 mm 1048N
- 1 alicate de pressão, regulação dupla, maxilas longas 1051
- 1 alicate de corte frontal, articulado, serviço pesado, grande esforço ⊥ 180 mm 1092V
- 1 martelo para mecânico, tipo alemão 600 g 1370
- 1 martelo com batentes plásticos intermutáveis 60 mm 1390
- 5 extractores cónicos de parafusos M3-M18 1430/S5
- 1 extractor universal de duas pernas 1500/3
- 1 paquímetro 1650
- 1 régua graduada semi-rígida 1683
- 1 riscador, extremidades em carboneto de tungsténio 1688
- 1 fita métrica 5 m 1692
- 1 apalpa - folgas 1708/13
- 1 pesca-peças magnético 1712E/2

€

5910VI/3T

6.600,00 059101063

Sortido recomendado para usar com o item C30M

5935VI/2MB

jogo de 133 ferramentas para caixa de ferramentas C35, em tabuleiros maleáveis

► Manutenção industrial

Nr. Peças/Descrição

- 21 chaves mistas, boca-luneta 6-7-8-9-10-11-12-13-14-15-16-17-18-19-20-21-22-24-27-30-32 mm
- 8 chaves de bocas 6x7-8x9-10x11-12x13-14x15
16x17-18x19-20x22 mm
- 1 alicate de charneira fechada 250 mm
- 19 chaves de caixa sextavadas, quadra de 1/2" ○ 10-11-12-13-14-15-16-17-18-19-20-21-22-23-24-26-27-30-32 mm
- 1 extensões com quadras macho e fêmea - 1/2" 125 mm
- 1 extensões com quadras macho e fêmea - 1/2" 150 mm
- 1 cardan com quadras macho e fêmea de 1/2"
- 1 cabo T correção, quadra de 1/2"
- 1 roquete reversível, quadra de 1/2" ⊕
- 1 Chave ajustável 250 mm
- 1 alicate de pressão 240 mm
- 1 Alicates de corte diagonal para trabalhos pesados \nlessgtr 160 mm
- 1 alicate de pontas semi-redondas extra-longas \nlessgtr 180 mm
- 1 Alicates de pontas semi-redondas extralongas ● 160 mm
- 1 alicates de freios interiores com pontas direitas ○ 180 mm
- 1 alicates de freios interiores com pontas curvas ● 170 mm
- 1 alicates de freios exteriores com pontas direitas ● 175 mm
- 1 alicates de freios exteriores com pontas curvas ● 175 mm
- 13 chaves de caixa sextavadas, quadra de 1/4" ○ 4-4,5-5-5,5-6-7-8-9-10-11-12-13-14 mm
- 1 extensão, quadra 1/4" 50 mm
- 1 extensão, quadra 1/4" 150 mm
- 1 cardan com quadras macho e fêmea de 1/4"
- 1 extensão com punho, quadra macho de 1/4"
- 1 roquete reversível, quadra de 1/4" ⊕
- 1 cabo T correção, quadra de 1/4"
- 7 chaves para parafusos de perfil de fenda ● 2,5x50-3x75-3,5x100-4x100-5,5x125-6,5x150-8x200 mm
- 2 chave para parafusos de perfil de fenda série curta ● 4x30-6,5x30 mm
- 7 chaves para parafusos de perfil Phillips® ⊕ PH0x60-PH0x100-PH1x80-PH1x120-PH2x100-PH2x150-PH3x150 mm
- 2 chaves para parafusos de perfil Phillips® série curta ⊕ PH1x30-PH2x30 mm
- 1 busca - pólos ● 4x30-6,5x30 mm
- 9 chaves macho sextavadas com uma extremidade esférica cromadas ○
- 6 chaves em T com três extremidades macho hexagonal 2,5-3-4-5-6-8 mm
- 5 saca-troços Ø 2-3-4-5-6 mm
- 1 punção de bico Ø 4 mm
- 1 escopros planos 200 mm
- 1 tesoura modelo americano 250 mm
- 1 tesoura de electricista
- 1 martelo para mecânico, tipo alemão 500 g
- 1 martelo com batentes plásticos intermutáveis Ø 45 mm
- 1 limas quadradas meia-murças, com punho 200 mm
- 1 limas triangulares meia-murças, com punho 200 mm
- 1 limas chatas meia-murças, com punho 200 mm
- 1 limas meia-cana meia-murças, com punho 200 mm
- 1 limas redondas meia-murças, com punho 200 mm
- 1 serrote com folha de serra bi-metálica 440 mm

Refa. Nr.	TR
42	MB12
55	MB12
1048N	MB12
920A	MB37
920AN/125	MB37
920AN/250	MB37
920/25	MB37
920/42	MB37
920/55	MB37
111E	MB37
1052	MB37
1084BM	MB37
1150BM	MB37
1166BM	MB37
1032	MB37
1034	MB37
1036	MB37
1038	MB37
900	MB37
900/20	MB37
900/21	MB37
900/25	MB37
900BG/30	MB37
900/55	MB37
900/42	MB37
1260	MB44
1260N	MB44
1262	MB44
1262N	MB44
1253	MB44
96BPC/SC9	MB44
951	MB44
31	MB55
32	MB55
35	MB55
1112	MB55
1128BMX	MB55
1370	MB55
1390	MB55
1719BMA...Q	MB55
1719BMA...T	MB55
1719BMA...P	MB55
1719BMA...M	MB55
1719BMA...R	MB55
1726	MB55



MB12



MB37

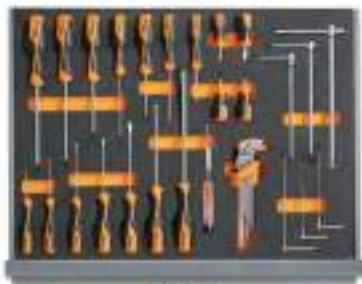

MB44



MB55

5935VI/2MB € 2.540,00 059351316

Sortido recomendado em combinação com C35



5957VI

sortido 162 ferramentas

► Manutenção industrial

Nr. Peças/Descrição	Refa. Nr.
6 saca-troços Ø 2 - 3 - 4 - 5 - 6 - 8 mm	31/SP6
2 punções, 1 punção de bico e 3 escopros	38/SP6
18 chaves mistas, boca-luneta 6-7-8-10-11-12-13-14-15-16-17-19-21-22-24-27-30-32 mm	42
12 chaves de bocas 6x7 ÷ 30x32 mm	55/S12X
8 chaves macho hexagonal 2 - 2,5 - 3 - 4 - 5 - 6 - 8 - 10 mm	96T/S8
8 T9 - T10 - T15 - T20 - T25 - T27 - T30 - T40	97TX/SC8
1 Chave ajustável 250 mm	111E
13 chaves de caixa 12 faces, quadra de 1/2" em suporte metálico Ø 10+22 mm	920B/SB13
8 chaves de caixa 12 faces, quadra de 1/2" em suporte metálico Ø 23+32 mm	920B/SB8
4 chaves de caixa com ponta de fenda ● 1,2x6,5 - 1,2x8 - 1,6x9 - 2x12 mm	920LP
3 chaves de caixa com ponta de perfil Phillips® PH2 - 3 - 4	920PH
1 extensão com quadras macho e fêmea de 1/2" 125 mm	920/21
1 extensão com quadras macho e fêmea de 1/2" 255 mm	920/22
1 cardan com quadras macho e fêmea de 1/2"	920/25
1 cabo T corrediço, quadra de 1/2"	920/42
1 roquete reversível, quadra de 1/2" ®	920/55
1 alavanca com extremidades chata e pontiaguda	963
2 alicates de freios interiores com pontas direitas Ø 140 - 180 mm	1032
2 alicates de freios interiores com pontas curvas Ø 130 - 170 mm	1034
2 alicates de freios exteriores com pontas direitas ● 140 - 175 mm	1036
2 alicates de freios exteriores com pontas curvas ● 135 - 175 mm	1038
1 alicate de charneira fechada 250 mm	1048N
1 alicate de pressão, regulação dupla, maxilas longas	1051
1 Alicates de corte diagonal para trabalhos pesados ⚡ 160 mm	1084BM
1 alicate de corte frontal, articulado, serviço pesado, grande esforço ⚡ 180 mm	1092V
1 tesoura modelo americano 250 mm	1112
1 tesoura modelo americano com lâminas direitas e estreitas 250 mm	1114
1 tesoura de electricista	1128BMX
1 alicate de pontas semi-redondas extra-longas = 180 mm	1150BM
1 Alicates de pontas semi-redondas extralongas ● 160 mm	1166BM
1 Alicates de pontas curvas semirredondas extralongas ● 160 mm	1168BM
7 chaves para parafusos de perfil de fenda ● 2,5x50 - 3x75 - 4x100 - 5,5x125 - 6,5x150 - 8x200 - 10x200 mm	1260
4 chaves para parafusos de perfil Phillips® PH0x60 - PH1x80 - PH2x100 - PH3x150 mm	1262
3 martelo para mecânico, tipo alemão 300 - 600 - 1000 g	1370
1 martelo com batentes plásticos intermutáveis Ø 35 mm	1390
1 fita métrica 5 m	1692
1 pesca-peças magnético 1,8 kg	1712E/2
1 rascador curvo 200 mm	1717A
1 rascador triangular 200 mm	1717B
5 limas perfis diversos 200 mm	1719BMA8/S5
1 serrote com folha de serra bi-metálica	1725
1 almotolia metálica 200 cc	1751
1 escopros planos 200 mm	35
1 buril, nervurado 200 mm	37
11 chaves cachimbo 6 faces 8 - 10 - 11 - 12 - 13 - 14 - 16 - 17 - 19 - 22 - 24 mm	932
1 alicate de pressão 240 mm	1052
1 alicate de pressão 280 mm	1060
1 alicate de pressão 290 mm	1062
1 martelo anti - recuo com batentes plásticos intermutáveis Ø 50 mm	1392
1 extractor universal de duas pernas 25+130 mm	1500N/2
1 paquímetro	1650
1 régua graduada semi-rígida 300 mm	1683
1 rascador, extremidades em carboneto de tungsténio	1688A
1 apalpa - folgas	1708/13
1 navalha com entalhe para descarnar	1777BM
1 x - acto com lâmina divisível de 18 mm 170 mm	1771BM
1 Alicates de corte diagonal ⚡ 160 mm	1082BM

€

5957VI 3.920,00 059571005

Sortido recomendado em combinação com C57SA - C57SB - C57SP

5954VI

jogo de 133 ferramentas

► Manutenção industrial

Nr. Peças/Descrição	Refa. Nr.
5 saca-troços Ø 2-3-4-5-6 mm	31
1 punção de bico Ø 4 mm	32
2 escopros planos 200-250 mm	35
18 chaves mistas, boca-luneta 6+14 - 16 - 17 - 18 - 19 - 21 - 22 - 24 - 27 - 30 mm	42
12 chaves de bocas 6x7 - 8x9 - 10x11 - 12x13 - 14x15 - 16x17 - 18x19 - 20x22 - 21x23 - 24x26 - 27x29 - 30x32 mm	55
12 chaves macho hexagonal Ø 2+10 mm	96/SC12
1 Chave ajustável 250 mm	111E
1 chaves para tubos modelo Sueco mordentes a 45° 320 mm	374
20 chaves de caixa sextavadas, quadra de 1/2" Ø 10+24 - 26 - 27 - 28 - 30 - 32 mm	920A
6 chaves de caixa com ponta hexagonal, quadra de 1/2" Ø 5 - 6 - 8 - 10 - 12 - 14 mm	920ME
1 extensão com quadras macho e fêmea de 1/2" 125 mm	920/21
1 extensão com quadras macho e fêmea de 1/2" 255 mm	920/22
1 cardan com quadras macho e fêmea de 1/2"	920/25
1 extensão articulada com punho em T, quadra de 1/2"	920/40
1 cabo T corrediço, quadra de 1/2"	920/42
1 roquete reversível, quadra de 1/2" Ⓢ	920/55
6 chaves em T com três extremidades macho hexagonal 2,5 - 3 - 4 - 5 - 6 - 8 mm	951
2 alicates de freios interiores com pontas direitas Ø 140 - 180 mm	1032
1 alicates de freios interiores com pontas curvas Ø 170 mm	1034
2 alicates de freios exteriores com pontas direitas ● 140x1,3 - 175 mm	1036
1 alicates de freios exteriores com pontas curvas ● 175 mm	1038
1 alicate de charneira fechada 250 mm	1048N
1 alicate de pressão 240 mm	1052
1 Alicates de corte diagonal para trabalhos pesados ⚡ 160 mm	1084BM
1 alicate de corte frontal, articulado, serviço pesado, grande esforço ⚡ 180 mm	1092V
1 tesoura modelo americano 250 mm	1112
1 tesoura de electricista	1128BMX
1 alicate de pontas semi-redondas extra-longas = 180 mm	1150BM
1 Alicates de pontas semi-redondas extralongas ● 160 mm	1166BM
1 busca - pólos ●	1253
2 chaves para parafusos de perfil de fenda ● 8x150 - 10x200 mm	1260
2 chave para parafusos de perfil de fenda série curta ● 4x30 - 6,5x30 mm	1260N
2 chaves para parafusos de perfil Phillips® Ⓢ PH3x150 - PH4x200 mm	1262
2 chaves para parafusos de perfil Phillips® série curta Ⓢ PH1x30 - PH2x30 mm	1262N
8 chaves para parafusos	1263/D8
2 martelo para mecânico, tipo alemão 300 - 500 g	1370
1 martelo com batentes plásticos intermutáveis Ø 45 mm	1390
1 fita métrica 5 m	1692
1 pesca-peças magnético 0,5 kg	1712E/1
5 limas perfis diversos 200 mm	1719BMA8/S5
1 serrote com folha de serra bi-metálica	1726BM
1 almotolia plástica 250 cc	1754



€ 

5954VI 2.680,00 059541053

Sortido recomendado em combinação com C54S-C55C

5904VU/1M

sortido de 90 ferramentas

► Utilização universal

Nr. Peças/Descrição

- 16 chaves mistas, boca-luneta 6÷21 mm
- 8 chaves de bocas 6x7 - 8x9 - 10x11 - 12x13 - 14x15 - 16x17 - 18x19 - 20x22 mm
- 9 chaves macho hexagonal \odot 1,5 - 2 - 2,5 - 3 - 4 - 5 - 6 - 8 - 10 mm
- 6 chaves para parafusos de perfil Torx® \odot T8-T10-T15-T20-T25-T30
- 3 chaves para parafusos de perfil de fenda \bullet 3x75-4x100-6,5x150 mm
- 3 chaves para parafusos de perfil Phillips® \oplus PH0x60-PH1x80-PH2x100 mm
- 8 chaves macho sextavadas \odot 2-2,5-3-4-5-6-7-8 mm
- 1 extensões com quadras macho e fêmea - 1/2" 125 mm
- 1 extensões com quadras macho e fêmea - 1/2" 250 mm
- 1 cardan com quadras macho e fêmea de 1/2"
- 1 cabo T correção, quadra de 1/2"
- 1 roquete reversível, quadra de 1/2" \oplus
- 19 chaves de caixa sextavadas, quadra de 1/2" \odot 10÷24 - 26 - 27 - 30 - 32 mm
- 1 Alicates de corte diagonal para trabalhos pesados ∇ 160 mm
- 1 alicate de pontas semi-redondas extra-longas \equiv 180 mm
- 1 Alicates de pontas semirredondas extralongas \bullet 160 mm
- 1 alicate de charneira fechada 250 mm
- 1 alicate de pressão 240 mm
- 2 escopros planos 100 - 200 mm
- 1 martelo para mecânico, tipo alemão 300 g
- 1 martelo com batentes plásticos intermutáveis \varnothing 35 mm
- 1 alicates de freios interiores com pontas direitas \odot 180 mm
- 1 alicates de freios interiores com pontas curvas \odot 170 mm
- 1 alicates de freios exteriores com pontas direitas \bullet 175 mm
- 1 alicates de freios exteriores com pontas curvas \bullet 175 mm

Refa. Nr.	TR
42	M05
55	M33
96/SC9	M33
1267TX	M204
1260	M201
1262	M201
96T	M50
920AN/125	M83
920AN/250	M83
920/25	M83
920/42	M83
920/55	M83
920A	M83
1084	M137
1150	M137
1166	M137
1048N	M153
1052	M153
35	M234
1370	M234
1390	M234
1032	M145
1034	M145
1036	M145
1038	M145



€



5904VU/1M

1.550,00 059041201

Sortido recomendado em combinação com RSC51 - RSC23T - RSC24 - RSC24A - RSC24AXL - RSC24L/7 - RSC24L-CAB - RSC28 - C37 - C39 - C39T - C39SM - C39MD - RSC50 - RSC55 - C59

5904VU/2M

sortido de 144 ferramentas

► Utilização universal

Nr. Peças/Descrição

- 16 chaves mistas, boca-luneta 6÷21 mm
- 8 chaves de bocas 6x7 - 8x9 - 10x11 - 12x13 - 14x15 - 16x17 - 18x19 - 20x22 mm
- 9 chaves macho hexagonal \odot 1,5 - 2 - 2,5 - 3 - 4 - 5 - 6 - 8 - 10 mm
- 3 chaves para parafusos de perfil de fenda \bullet 3x75-4x100-6,5x150 mm
- 3 chaves para parafusos de perfil Phillips® \oplus PH0x60-PH1x80-PH2x100 mm
- 6 chaves para parafusos de perfil Torx® \otimes T8-T10-T15-T20-T25-T30
- 8 chaves macho sextavadas \odot 2-2,5-3-4-5-6-7-8 mm
- 1 extensões com quadras macho e fêmea - 1/2" 125 mm
- 1 extensões com quadras macho e fêmea - 1/2" 250 mm
- 1 cardan com quadras macho e fêmea de 1/2"
- 1 cabo T correção, quadra de 1/2"
- 1 roquete reversível, quadra de 1/2" \oplus
- 19 chaves de caixa sextavadas, quadra de 1/2" \odot 10÷24 - 26 - 27 - 30 - 32 mm
- 1 Alicates de corte diagonal para trabalhos pesados ∇ 160 mm
- 1 alicate de pontas semi-redondas extra-longas \equiv 180 mm
- 1 Alicates de pontas semirredondas extralongas \bullet 160 mm
- 1 alicate de charneira fechada 250 mm
- 1 alicate de pressão 240 mm
- 2 escopros planos 100 - 200 mm
- 1 martelos para mecânico 300 g
- 1 Martelo com batentes em plástico \varnothing 35 mm
- 1 alicates de freios interiores com pontas direitas \odot 180 mm
- 1 alicates de freios interiores com pontas curvas \odot 170 mm
- 1 alicates de freios exteriores com pontas direitas \bullet 175 mm
- 1 alicates de freios exteriores com pontas curvas \bullet 175 mm
- 1
- 1 fita métrica 5 m
- 1 mini serrote
- 1 10 lâminas divisível de 18 mm para x-acto ref. 1771, 1771BM, 1771HD
- 1 x - acto com lâmina divisível de 18 mm
- 5 bits para parafusos ranhurados, coloridos \bullet 0,5x3 - 0,6x4,5 - 0,8x5,5 - 1x5,5 - 1,2x6,5 mm
- 8 bits sextavados para aparafusadoras eléctricas, coloridos \odot 2 - 2,5 - 3 - 4 - 5 - 6 - 8 - 10 mm
- 5 bits para parafusos Phillips®, coloridos \oplus PH0 - PH1 - PH2 - PH3 - PH4
- 4 bits para parafusos Phillips®, coloridos \oplus PZ1 - PZ2 - PZ3 - PZ4
- 11 bits para parafusos Torx®, coloridos \otimes T6-T7-T8-T9-T10-T15-T20-T25-T27-T30-T40
- 8 bits para parafusos invioláveis Torx®, coloridos \oplus T9-T10-T15-T20-T25-T27-T30-T40
- 1 porta-pontas magnético com punho 230 mm
- 1 chave de bits reversível 100 mm
- 5 limas perfis diversos 200 mm
- 1 adaptadores para aparafusadoras
- 1 extensão para porta-bits magnético

Refa. Nr.	TR
42	M05
55	M33
96/SC9	M33
1260	M201
1262	M201
1267TX	M204
96T	M50
920AN/125	M83
920AN/250	M83
920/25	M83
920/42	M83
920/55	M83
920A	M83
1084	M137
1150	M137
1166	M137
1048N	M153
1052	M153
35	M237
1370T	M237
1390N	M237
1032	M145
1034	M145
1036	M145
1038	M145
VPM3	VPM3
1692	M294
1725CR	M294
1771RL	M294
1771	M294
860LP	M85
860PE	M85
860PH	M85
860PZ	M85
860TX	M85
860RTX	M85
851SR	M85
860/55	M85
1719BMA8/S5	M236
892/0	M85
882P	M85



M05 M33 M204 M201



M50 M83



M137 M153 M237 M145



VPM3 M294 M85 M236

€ 

5904VU/2M

2.020,00 059041212

Sortido recomendado em combinação com RSC23T - RSC24 - RSC24A - RSC24AXL - RSC24L/7 - RSC24L-CAB
RSC28 - C37 - C39 - C39SM - C39MD - C39T - RSC55 - C59

5904VU/2T

sortido de 104 ferramentas

► Utilização universal

Nr. Peças/Descrição

- 7 chaves para parafusos de perfil de fenda 2,5x50 - 3x75 - 3,5x100 - 4x125
5,5x100 - 5,5x150 - 6,5x150 mm
- 6 chaves para parafusos de perfil Phillips® PH0x60 - PH0x100 - PH1x80 - PH1x120 - PH2x100 - PH2x150 mm
- 19 chaves de caixa sextavadas, quadra de 1/2" 10-11-12-13-14-15-16-17-18-19
20-21-22-23-24-26-27-30-32 mm
- 1 extensão com quadras macho e fêmea de 1/2" 125 mm
- 1 extensão com quadras macho e fêmea de 1/2" 255 mm
- 1 cardan com quadras macho e fêmea de 1/2"
- 1 cabo T corredeira, quadra de 1/2" 305 mm
- 1 roquete reversível, quadra de 1/2"
- 1 alicates de freios interiores com pontas direitas 180 mm
- 1 alicates de freios interiores com pontas curvas 170 mm
- 1 alicates de freios exteriores com pontas direitas 175 mm
- 1 alicates de freios exteriores com pontas curvas 175 mm
- 1 alicate de charneira fechada 250 mm
- 1 alicate de pressão 240 mm
- 1 Alicates de corte diagonal para trabalhos pesados 160 mm
- 1 alicate de pontas semi-redondas extra-longas 180 mm
- 1 Alicates de pontas semirredondas extralongas 160 mm
- 2 escopros planos 100-200 mm
- 1 martelo para mecânico, tipo alemão 300 g
- 1 martelo com batentes plásticos intermutáveis Ø 35 mm
- 6 chaves em T com três extremidades macho hexagonal 2,5-3-4-5-6-8 mm
- 8 chaves de bocas 6x7-8x9-10x11-12x13-14x15
16x17-18x19-20x22 mm
- 9 chaves macho hexagonal 1,5+10 mm
- 16 chaves mistas, boca-luneta 6-7-8-9-10-11-12-13-14-15-16-17
18-19-20-21 mm
- 5 chaves mistas, boca-luneta 22-24-27-30-32 mm
- 1 tesoura de electricista
- 1 tesoura multiusos
- 1 limas quadradas meia-murças, com punho 200 mm
- 1 limas chatas meia-murças, com punho 200 mm
- 1 limas triangulares meia-murças, com punho 200 mm
- 1 limas meia-cana meia-murças, com punho 200 mm
- 1 limas redondas meia-murças, com punho 200 mm
- 1 serrote com folha de serra bi-metálica
- 1 folhas de serra (HSS bi-metálicas)
- 1 x - acto com lâmina divisível de 18 mm 170 mm
- 1 185 mm

Refa. Nr.	TR
1260	T199
1262	T202
920A	T83
920/21	T83
920/22	T83
920/25	T83
920/42	T83
920/55	T83
1032	T145
1034	T145
1036	T145
1038	T145
1048N	T153
1052	T153
1084	T138
1150	T138
1166	T138
35	T234
1370	T234
1390	T234
951	T68
55	T33
96/SC9	T33
42	T05
42	T06
1128BMX	T284
1130BMX	T284
1719BMA...Q	T284
1719BMA...P	T284
1719BMA...T	T284
1719BMA...M	T284
1719BMA...R	T284
1726BM	T284
1728BM	T284
1771BM	T284
1778V18	T284



T199 T202 T83



T145 T153 T138 T234



T68 T33 T05 T06



T284

€

5904VU/2T

1.850,00 059041070

Sortido recomendado em combinação com RSC23T - RSC24 - RSC24A - RSC24AXL - RSC24L/7 - RSC24L-CAB - RSC28 - C37 - C39 - C39SM - C39MD - C39T - RSC55 - C59

5904VU/3T

sortido de 146 ferramentas

► Utilização universal

Nr. Peças/Descrição

- 16 chaves mistas, boca-luneta 6÷21 mm
- 5 chaves mistas, boca-luneta 22 - 24 - 27 - 30 - 32 mm
- 5 saca-troços Ø 2 - 3 - 4 - 5 - 6 mm
- 1 punção de bico Ø 4 mm
- 12 chaves de bocas 6x7 - 8x9 - 10x11 - 12x13 - 14x15 - 16x17 - 18x19 - 20x22 - 21x23 - 24x26 - 27x29 - 30x32 mm
- 9 chaves macho hexagonal ○ 1,5 - 2 - 2,5 - 3 - 4 - 5 - 6 - 8 - 10 mm
- 6 chaves macho sextavadas ○ 2 - 2,5 - 3 - 4 - 5 - 6 mm
- 6 chaves para parafusos de perfil Torx® ○ T10-T15-T20-T25-T27-T30
- 5 chaves de caixa com ponta hexagonal, quadra de 1/2" ○ 5 - 6 - 8 - 10 - 12 mm
- 1 extensão com quadras macho e fêmea de 1/2" 125 mm
- 1 extensão com quadras macho e fêmea de 1/2" 255 mm
- 1 cardan com quadras macho e fêmea de 1/2"
- 1 cabo T correção, quadra de 1/2"
- 1 roquete reversível, quadra de 1/2" Ⓢ
- 19 chaves de caixa sextavadas, quadra de 1/2" ○ 10÷24 - 26 - 27 - 30 - 32 mm
- 13 chaves de caixa sextavadas, quadra de 1/4" ○ 4-4,5-5-5,5-6-7-8-9-10-11-12-13-14 mm
- 6 chaves de caixa com ponta sextavadas, quadra de 1/4" ○ 2,5-3-4-5-6-8 mm
- 1 extensão, quadra 1/4" 50 mm
- 1 extensão, quadra 1/4" 150 mm
- 1 cardan com quadras macho e fêmea de 1/4"
- 1 extensão com punho, quadra macho de 1/4"
- 1 cabo T correção, quadra de 1/4" 115 mm
- 1 roquete reversível, quadra de 1/4" Ⓢ
- 1 alicates de freios interiores com pontas direitas ○ 180 mm
- 1 alicates de freios interiores com pontas curvas ○ 170 mm
- 1 alicates de freios exteriores com pontas direitas ● 175 mm
- 1 alicates de freios exteriores com pontas curvas ● 175 mm
- 1 alicate de pontas semi-redondas extra-longas = 180 mm
- 1 Alicates de pontas semirredondas extralongas ● 160 mm
- 1 Alicates de corte diagonal para trabalhos pesados † 160 mm
- 1 alicate de charneira fechada 250 mm
- 1 alicate de pressão 240 mm
- 4 chaves para parafusos de perfil de fenda ● 3x75 - 4x100 - 5,5x150 - 6,5x150 mm
- 3 chave para parafusos de perfil Pozidriv®-Supadriv® PZ0 - PZ1 - PZ2
- 7 chaves para parafusos de perfil Torx® ○ T6-T7-T8-T9-T10-T15-T20
- 2 escopros planos 100 - 200 mm
- 1 martelo para mecânico, tipo alemão 300 g
- 1 martelo com batentes plásticos intermutáveis Ø 35 mm
- 5 limas perfis diversos 200 mm

Refa. Nr.	TR
42	T05
42	T06
31	T31
32	T31
55	T31
96N/SC9	T31
96T	T52
97TTX	T55
920ME	T80
920/21	T80
920/22	T80
920/25	T80
920/42	T80
920/55	T80
920A	T80
900	T91
900ME	T91
900/20	T91
900/21	T91
900/25	T91
900BG/30	T91
900/42	T91
900/55	T91
1032	T145
1034	T145
1036	T145
1038	T145
1150	T138
1166	T138
1084	T138
1048N	T153
1052	T153
1260	T198
1269PZ	T198
1267TX	T205
35	T234
1370	T234
1390	T234
1719BMA&S5	T236



T05 T06 T31



T52 T55 T80



T91 T145 T138 T153



T198 T205 T234 T236

€

5904VU/3T 2.240,00 059041203

Sortido recomendado em combinação com RSC24 - RSC24A - RSC24AXL - RSC24L/7 - RSC24L-CAB - C37 - C39 - C39T - C39SM - C39MD - RSC50 - RSC55 - C59

5904VU/4T

sortido de 197 ferramentas em tabuleiros em plástico ABS

► Utilização universal

Nr. Peças/Descrição

- 1 punções Ø 4 mm
- 1 saca-troços Ø 4 mm
- 1 punção de bico Ø 4 mm
- 54 jogo com 52 pontas hexagonais, 10 mm, e 2 acessórios
- 17 chaves mistas, boca-luneta 6-7-8-10-11-12-13-14-16-17-18-19-21-22-24-27-30 mm
- 7 chaves de luneta curvatura profunda 6x7-8x9-10x11-12x13-14x15-16x17-18x19 mm
- 19 chaves de caixa sextavadas, quadra de 1/2" ○ 10-11-12-13-14-15-16-17-18-19-20-21-22-23-24-26-27-30-32 mm
- 1 extensão com quadras macho e fêmea de 1/2" 125 mm
- 1 extensão com quadras macho e fêmea de 1/2" 250 mm
- 1 cardan com quadras macho e fêmea de 1/2"
- 1 cabo T corredeira, quadra de 1/2" 305 mm
- 1 roquete reversível, quadra de 1/2" ⊗
- 13 chaves de caixa sextavadas, quadra de 1/4" ○ 4-4,5-5-5,5-6-7-8-9-10-11-12-13-14 mm
- 6 chaves de caixa com ponta sextavadas, quadra de 1/4" ○ 2,5-3-4-5-6-8 mm
- 1 extensão, quadra 1/4" 50 mm
- 1 extensão, quadra 1/4" 150 mm
- 1 cardan com quadras macho e fêmea de 1/4"
- 1 extensão com punho, quadra macho de 1/4"
- 1 cabo T corredeira, quadra de 1/4" 115 mm
- 1 roquete reversível, quadra de 1/4" ⊗
- 1 Alicates de corte diagonal ✂ 160 mm
- 1 alicate de pontas semi-redondas extra-longas = 180 mm
- 1 alicate de charneira fechada 250 mm
- 7 chaves para parafusos de perfil de fenda ● 2,5x50 - 3x75 - 3,5x100 - 4x125 - 5,5x100 - 5,5x150 - 6,5x150 mm
- 6 chave para parafusos de perfil Phillips® ⊕ PH0x60 - PH1x80 - PH1x120 - PH2x100 - PH2x150 - PH3x150 mm
- 7 chaves para parafusos de perfil Torx®, com punho ⊙ T6-T7-T8-T9-T10-T15-T20
- 2 escopros planos 100-200 mm
- 1 martelo para mecânico, tipo alemão 300 g
- 1 martelo com batentes plásticos intermutáveis Ø 35 mm
- 7 chaves macho hexagonal com uma extremidade esférica, brunidas ○ 2,5-3-4-5-6-8-10 mm
- 1 chaves macho hexagonal ○ 12 mm
- 31 jogo de 30 pontas com porta pontas magnético de desengate rápido em caixa plástica ● ○ ⊕ ⊙ ⊗ ⊕ ⊗
- 1 chave de caixa porta-pontas com encaixe quadra fêmea

Refa. Nr.	TR
30	
31	
32	
867/C52	
42	T01
90	T40
920A	T83
920/21	T83
920/22	T83
920/25	T83
920/42	T83
920/55	T83
900	T91
900ME	T91
900/20	T91
900/21	T91
900/25	T91
900BG/30	T91
900/42	T91
900/55	T91
1082	T156
1150	T156
1048N	T156
1201E	T211
1202E	T213
1207E/TX	T216
35	T234
1370	T234
1390	T234
96BP	T259
96N	T259
860MIX/A31	T259
895/1	T259



T01

T83



T91

T156

T40

T211



T213

T216

T234

T259



€



5904VU/4T

1.740,00 059241100

Sortido recomendado para utilização conjunta com referências RSC23T - RSC24 - RSC24A - RSC24AXL - RSC24L/7 - RSC24L-CAB - C37 - C39 - C39T - C39SM - C39MD - RSC55 - C59

5908VU/2T

jogo de 161 ferramentas em módulos soft ABS

► Utilização universal

Nr. Peças/Descrição

- 16 chaves mistas, boca-luneta 6+21 mm
- 5 chaves mistas, boca-luneta 22 - 24 - 27 - 30 - 32 mm
- 5 saca-troços Ø 2 - 3 - 4 - 5 - 6 mm
- 1 punção de bico Ø 4 mm
- 12 chaves de bocas 6x7 - 8x9 - 10x11 - 12x13 - 14x15 - 16x17 - 18x19 - 20x22 - 21x23 - 24x26 - 27x29 - 30x32 mm
- 9 chaves macho hexagonal Ø 1,5 - 2 - 2,5 - 3 - 4 - 5 - 6 - 8 - 10 mm
- 7 chaves de luneta curvatura profunda 6x7-8x9-10x11-12x13-14x15-16x17-18x19 mm
- 6 chaves macho sextavadas Ø 2-2,5-3-4-5-6 mm
- 6 chaves para parafusos de perfil Torx® Ⓞ T10-T15-T20-T25-T27-T30
- 19 chaves de caixa sextavadas, quadra de 1/2" Ⓞ 10-11-12-13-14-15-16-17-18-19-20-21-22-23-24-26-27-30-32 mm
- 5 chaves de caixa com ponta hexagonal, quadra de 1/2" Ⓞ 5-6-8-10-12 mm
- 1 extensões com quadras macho e fêmea - 1/2" 125 mm
- 1 extensões com quadras macho e fêmea - 1/2" 250 mm
- 1 cardan com quadras macho e fêmea de 1/2"
- 1 cabo T corrediço, quadra de 1/2" 305 mm
- 1 roquete reversível, quadra de 1/2" Ⓞ
- 13 chaves de caixa sextavadas, quadra de 1/4" Ⓞ 4-4,5-5-5,5-6-7-8-9-10-11-12-13-14 mm
- 6 chaves de caixa com ponta sextavadas, quadra de 1/4" Ⓞ 2,5-3-4-5-6-8 mm
- 1 extensão, quadra 1/4" 50 mm
- 1 extensão, quadra 1/4" 150 mm
- 1 cardan com quadras macho e fêmea de 1/4"
- 1 extensão com punho, quadra macho de 1/4"
- 1 cabo T corrediço, quadra de 1/4" 115 mm
- 1 roquete reversível, quadra de 1/4" Ⓞ
- 1 Alicates de corte diagonal para trabalhos pesados ≤ 160 mm
- 1 alicate de pontas semi-redondas extra-longas = 180 mm
- 1 Alicates de pontas semirredondas extralongas ● 160 mm
- 1 alicates de freios interiores com pontas direitas Ⓞ 180 mm
- 1 alicates de freios interiores com pontas curvas Ⓞ 170 mm
- 1 alicates de freios exteriores com pontas direitas ● 175 mm
- 1 alicates de freios exteriores com pontas curvas ● 175 mm
- 1 alicate de charneira fechada 250 mm
- 1 alicate de pressão 240 mm
- 7 chaves para parafusos de perfil Phillips® ● 2,5x50-3x75-3,5x100-4x125-5,5x100-5,5x150-6,5x150 mm
- 3 chaves para parafusos de perfil Phillips® ● 8x150-8x200-10x200 mm
- 2 chave para parafusos de perfil de fenda série curta ● 4x30-6,5x30 mm
- 6 chaves para parafusos de perfil Phillips® Ⓞ PH0x60-PH0x100-PH1x80-PH1x120-PH2x100-PH2x150 mm
- 2 chaves para parafusos de perfil Phillips® Ⓞ PH3x150-PH4x200 mm
- 2 chave para parafusos de perfil Phillips® série curt Ⓞ PH1x30-PH2x30 mm
- 2 escopros planos 100-200 mm
- 1 martelo para mecânico, tipo alemão 300 g
- 1 martelo com batentes plásticos intermutáveis Ø 35 mm
- 1 limas quadradas meia-murças, com punho 200 mm
- 1 limas triangulares meia-murças, com punho 200 mm
- 1 limas chatas meia-murças, com punho 200 mm
- 1 limas meia-cana meia-murças, com punho 200 mm
- 1 limas redondas meia-murças, com punho 200 mm
- 1

Refa. Nr.	TR
42	T05
42	T06
31	T31
32	T31
55	T31
96N/SC9	T31
90	T40
96T	T52
97TTX	T55
920A	T82
920ME	T82
920AN/125	T82
920AN/250	T82
920/25	T82
920/42	T82
920/55	T82
900	T91
900ME	T91
900/20	T91
900/21	T91
900/25	T91
900BG/30	T91
900/42	T91
900/55	T91
1084	T138
1150	T138
1166	T138
1032	T145
1034	T145
1036	T145
1038	T145
1048N	T153
1052	T153
1290	T170
1290	T171
1290N	T171
1292	T172
1292	T173
1292N	T173
35	T234
1370	T234
1390	T234
1719BMA...Q	T236
1719BMA...T	T236
1719BMA...P	T236
1719BMA...M	T236
1719BMA...R	T236
VP4	T236



€

5908VU/2T

2.560,00 059081136

Seleção recomendada em combinação com as referências RSC23T - RSC24 (6-7-8 gavetas) - RSC24A - RSC24AXL - RSC24L/7 - RSC24L-CAB - RSC28 - C37 (6-7-8 gavetas) - C39 (6-7-8 gavetas) - C39MD - C39SM - C59 - RSC50 - RSC55

5914VU/M

jogo de 109 ferramentas para trolley C14, em tabuleiros de espuma EVA

► Utilização universal

Nr. Peças/Descrição

- 31 jogo de 30 pontas com porta pontas magnético de desengate rápido em caixa plástica ● ○ ⊕ ⊕ ⊕ ⊕
- 1 chave de caixa porta-pontas com encaixe quadra fêmea
- 13 chaves de caixa sextavadas, quadra de 1/4" ○ 4-4,5-5,5-6-7-8-9-10-11-12-13-14 mm
- 1 extensão, quadra 1/4" 150 mm
- 1 cardan com quadras macho e fêmea de 1/4"
- 1 extensão 1/4" com punho, série curta
- 1 cabo T correção, quadra de 1/4"
- 1 roquete reversível, quadra de 1/4" ⊕
- 16 chaves de caixa sextavadas, quadra de 1/2" ○ 10-11-12-13-14-15-16-17-18-19-21-22-24-27-30-32 mm
- 1 cardan com quadras macho e fêmea de 1/2"
- 1 extensões com quadras macho e fêmea - 1/2"
- 1 cabo T correção, quadra de 1/2"
- 1 roquete reversível, quadra de 1/2" ⊕
- 16 chaves mistas, boca-luneta 6-7-8-9-10-11-12-13-14-15-16-17-18-19-21-22 mm
- 9 chaves macho hexagonal ○
- 1 Chave ajustável 250 mm
- 1 tesoura de electricista
- 1 fita métrica 5 mt
- 1 x - acto com lâmina divisível de 18 mm
- 1 alicate de charneira fechada 250 mm
- 1 Alicates de corte diagonal ✂ 160 mm
- 1 alicate de pontas semi-redondas extra-longas ≡ 180 mm
- 1 Alicates de pontas semi-redondas extralongas ● 160 mm
- 3 chaves para parafusos de perfil de fenda ● 3,5x100-5,5x125-6,5x150 mm
- 3 chaves para parafusos de perfil Phillips® ⊕ PH0x60-PH1x80-PH2x100 mm

Refa. Nr.	TR
860MIX/A31	MCT1
895/1	MCT1
900	MCT1
900/...	MCT1
900/25	MCT1
900BG/30C	MCT1
900/42	MCT1
900/55	MCT1
920A	MCT1
920/25	MCT1
920AN/125	MCT1
920/42	MCT1
920/55	MCT1
42	MCT2
96/SC9	MCT2
111E	MCT2
1128BMX	MCT2
1692/5	MCT2
1771	MCT2
1048N	MCT3
1082BM	MCT3
1150BM	MCT3
1166BM	MCT3
1260	MCT3
1262	MCT3



MC T1



MC T2



MC T3

5914VU/M

€



1.240,00 059140112

Jogo recomendado para utilização em combinação com o trolley de ferramentas C14

Nota: para que o módulo superior do trolley feche corretamente, o painel de ferramentas por baixo da tampa deve ser removido.

5988U/7M

sortido de 215 ferramentas em módulo soft

► Utilização universal

Nr. Peças/Descrição

Refa. Nr. TR



M01

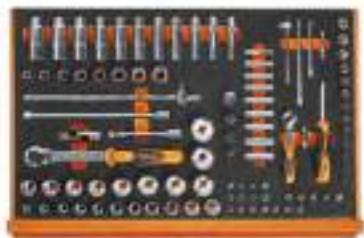

M100



M213



M33 M86 M136 M234

22	chaves mistas, boca-luneta 6-7-8-9-10-11-12-13-14-15-16-17-18-19-20-21-22-24-27-30-32-36 mm	42	M01
8	chaves de bocas 6x7-8x9-10x11-12x13-14x15-16x17-18x19-20x22 mm	55	M33
9	chaves macho hexagonal \varnothing 1,5÷10 mm	96/SC9	M33
7	pontas macho hexagonal \varnothing 4-5-6-7-8-10-12 mm	867PE	M86
7	pontas hexagonais \varnothing 4-5-6-7-8-10-12 mm	867PEEL	M86
5	pontas para parafusos de perfil XZN® \varnothing 5-6-8-10-12 mm	867XZN	M86
5	pontas com perfil XZN® \varnothing 5-6-8-10-12 mm	867XZNL	M86
7	pontas para parafusos de perfil Torx® \odot T20-T25-T30-T40-T45-T50-T55	867TX	M86
6	pontas para parafusos de perfil Torx® \odot T25-T30-T40-T45-T50-T55	867TXL	M86
7	pontas para parafusos de perfil Tamper Resistant Torx® \odot T20-T25-T30-T40-T45-T50-T55	867RTX	M86
1	chaves de caixa porta-pontas para artigos 867	867/1	M86
1	chaves de caixa porta-pontas para artigos 867	867/2	M86
1	chave de caixa porta-pontas com encaixe quadra fêmea	895/1	M100
1	chave de caixa porta-pontas com encaixe quadra fêmea	895/3	M100
1	chave de caixa porta-pontas com encaixe quadra fêmea	895/6	M100
13	chaves de caixa sextavadas, quadra de 1/4" \varnothing 4-4,5-5-5,5-6-7-8-9-10-11-12-13-14 mm	900	M100
9	chaves de caixa série longa, boca sextavadas \varnothing 5-6-7-8-9-10-11-12-13 mm	900L	M100
5	chaves de caixa com ponta sextavadas, quadra de 1/4" \varnothing 3-4-5-6-7 mm	900ME	M100
4	chaves de caixa com ponta de perfil de fenda \bullet 0,8x4-1x5,5-1,2x6,5-1,2x8 mm	900LP	M100
4	chaves de caixa com ponta de perfil Phillips® \oplus PH1-PH2-PH3-PH4	900PH	M100
7	chaves de caixa com ponta macho de perfil Torx® \odot T10-T15-T20-T25-T27-T30-T40	900TX	M100
1	extensão, quadra 1/4" 50 mm	900/20	M100
1	extensão, quadra 1/4" 100 mm	900/20L	M100
1	extensão, quadra 1/4" 150 mm	900/21	M100
1	cardan com quadras macho e fêmea de 1/4"	900/25	M100
1	extensão com punho, quadra macho de 1/4"	900BG/30	M100
1	cabo T correção, quadra de 1/4"	900/42	M100
1	roquete reversível, quadra de 1/4" \oplus	900/55	M100
21	chaves de caixa sextavadas, quadra de 1/2" \varnothing 8-10-11-12-13-14-15-16-17-18-19-20-21-22-23-24-26-27-28-30-32 mm	920A	M100
1	redução quadra fêmea de 1/2" para quadra macho de 3/8"	920/15	M100
1	cardan com quadras macho e fêmea de 1/2"	920/25	M100
1	extensões com quadras macho e fêmea - 1/2" 125 mm	920AN/125	M100
1	extensões com quadras macho e fêmea - 1/2" 250 mm	920AN/250	M100
1	cabo T correção, quadra de 1/2"	920/42	M100
1	roquete reversível, quadra de 1/2" \oplus	920/55	M100
8	chaves de caixa com quadra fêmea de 1/2", para parafusos com perfil Torx® \odot 10-12-14-16-18-20-22-24 mm	920FTX	M100
11	chaves de caixa série longa, boca hexagonal \varnothing 10-12-13-14-15-16-17-18-19-21-22	920AL	M100
1	Alicates de corte diagonal para trabalhos pesados \leq 160 mm	1084BM	M136
1	alicate de pontas semi-redondas extra-longas \equiv 180 mm	1150BM	M136
1	Alicates de pontas semi-redondas extralongas \bullet 160 mm	1166BM	M136
6	chaves para parafusos de perfil de fenda \bullet 2,5x50-3x75-4x100-5,5x125-6,5x150-8x200 mm	1201E	M213
1	chave para parafusos de perfil de fenda, série extra curta \bullet 4x30 mm	1201EN	M213
4	chave para parafusos de perfil Phillips® \oplus PH0x60-PH1x80-PH2x100-PH3x150 mm	1202E	M213
1	chave para parafusos de perfil Phillips®, série extra curta \oplus PH1X30 mm	1202EN	M213
12	chaves para parafusos de perfil Torx®, com punho \odot T6-T7-T8-T9-T10-T15-T20-T25-T27-T30-T40-T45	1207E/TX	M213
1	busca - pólos \bullet	1253	M213
2	escopros planos 100-200 mm	35	M234
1	martelo para mecânico, tipo alemão 300 g	1370	M234
1	martelo com batentes plásticos intermutáveis \varnothing 35 mm	1390	M234

5988U/7M

€ 2.580,00 059881019

Seleção recomendada em combinação com as referências RSC23T - RSC24 - RSC24A - RSC24A-XL - RSC24L - 24SL/CAB - RSC28 - C37 - C39 - C39SM - C39MD - RSC50 - RSC55 - C59



5915VU/0

sortido de 35 ferramentas

► Universais

Nr. Peças/Descrição

Nr. Peças/Descrição	Refa. Nr.
1 punção de bico 4 mm	32
1 escopros planos 125 mm	35
8 chaves de bocas 6x7-8x9-10x11-12x13-14x15-16x17-18x19-20x22 mm	55
7 Jogo de 7 chaves macho sextavadas \odot 1,5-2-2,5-3-4-5-6 mm	96/BGS7
1 Chave ajustável 150 mm	111E
1 alicate de charneira fechada 250 mm	1048N
1 alicate de corte diagonal, punhos com duplo revestimento PVC, acabamento industrial \leq 160 mm	1082G
1 tesoura de electricista	1128BMX
1 alicate combinado para trabalhos pesados, punhos com duplo revestimento PVC, acabamento industrial \equiv 180 mm	1150G
1 alicate de ponta semi-redondas com estrias, extra-longas, punhos com duplo revestimento PVC, acabamento industrial \bullet 160 mm	1166G
4 chaves para parafusos de perfil de fenda \bullet 3x75-4x100-5,5x100-6,5x150 mm	1201E
3 chave para parafusos de perfil Phillips® \oplus PH0x60-PH1x80-PH2x100 mm	1202E
1 martelo para mecânico, tipo alemão 300 g	1370
1 fita métrica 3 m	1692/3
1 x - acto com lâmina divisível de 18 mm 18 mm	1771
1 navalha manutenção automóvel	1778SOS
1 lanterna LED de elevada luminosidade, em alumínio anodizado robusto, até 500 lumens	1833S

€



5915VU/0

456,00 059151021

Sortido recomendado em combinação com C4 - C5 - C5S - C6T



5915VU/1

jogo de 45 ferramentas

► Universais

Nr. Peças/Descrição

Nr. Peças/Descrição	Refa. Nr.
2 punções \varnothing 2-3 mm	30
1 punção de bico \varnothing 4 mm	32
2 escopros planos 125-150 mm	34
1 buris 150 mm	36
14 chaves mistas, boca-luneta 6=14 - 17 - 19 - 21 - 22 - 24 mm	42
9 chaves macho hexagonal \odot 1,5 - 2 - 2,5 - 3 - 4 - 5 - 6 - 8 - 10 mm	96/SC9
1 Chave ajustável 250 mm	111E
1 alicate de charneira fechada 250 mm	1048N
1 alicate de corte diagonal, punhos com duplo revestimento PVC, acabamento industrial \leq 160 mm	1082G
1 tesoura de electricista	1128BMX
1 alicate combinado para trabalhos pesados, punhos com duplo revestimento PVC, acabamento industrial \equiv 180 mm	1150G
1 alicate de ponta semi-redondas com estrias, extra-longas, punhos com duplo revestimento PVC, acabamento industrial \bullet 160 mm	1166G
4 chaves para parafusos de perfil de fenda \bullet 3x75 - 4x100 - 5,5x100 - 6,5x150 mm	1201E
3 chave para parafusos de perfil Phillips® \oplus PH0x60 - PH1x80 - PH2x100 mm	1202E
1 martelo para mecânico, tipo alemão 300 g	1370
1 fita métrica 5 m	1692
1 x - acto com lâmina divisível de 18 mm	1771

€



5915VU/1

555,00 059151024

Sortido recomendado em combinação com C8 - C9 - C10 - C10S - C11 - CP15 - CP15L - C16 - CP17 - CP17L - C18



5915VU/2

jogo de 49 ferramentas

► Universais

Nr. Peças/Descrição

- 8 6x7 - 8x9 - 10x11 - 12x13 - 14x15
16x17 - 18x19 - 20x22 mm
- 9 chaves macho hexagonal \odot 1,5 - 2 - 2,5 - 3 - 4 - 5 - 6 - 8 - 10 mm
- 13 chaves de caixa sextavadas, quadra de 1/4" \odot 4 - 4,5 - 5 - 5,5 - 6 - 7 - 8 - 9 - 10 - 11 - 12 - 13 - 14 mm
- 1 extensão, quadra 1/4" 150 mm
- 1 cardan com quadras macho e fêmea de 1/4"
- 1 extensão com punho, quadra macho de 1/4"
- 1 cabo T corrediço, quadra de 1/4"
- 1 roquete reversível, quadra de 1/4" \otimes
- 1 alicate de charneira fechada 250 mm
- 1 tesoura de electricista
- 1 alicate combinado para trabalhos pesados, punhos com duplo revestimento PVC, acabamento industrial \equiv 180 mm
- 4 chaves para parafusos de perfil de fenda \bullet 3x75 - 4x100 - 5,5x150 - 6,5x150 mm
- 3 chave para parafusos de perfil Phillips® \oplus PH0x60 - PH1x80 - PH2x100 mm
- 1 martelo para mecânico, tipo alemão 300 g
- 1 fita métrica 3 m
- 1 10 lâminas divisível de 18 mm para x-acto ref. 1771, 1771BM, 1771HD
- 1 x-acto com lâmina divisível de 18 mm 18 mm

Refa. Nr.
55/B8N
96/SC9
900
900/21
900/25
900BG/30
900/42
900/55
1048N
1128BMX
1150G
1201E
1202E
1370
1692
1771RL
1771

5915VU/2

€ 482,00 059151027

Sortido recomendado em combinação com C7 - CP15 - C20 - C20L



5915VU/3

jogo de 74 ferramentas

► Utilização universal

Nr. Peças/Descrição

- 1 saca-troços \varnothing 4 mm
- 1 punção de bico \varnothing 4 mm
- 1 escopros planos 150 mm
- 14 chaves mistas, boca-luneta 6-7-8-10-11-12-13-14-15-16-17-19-22-24 mm
- 9 chaves macho hexagonal \odot 1,5÷10 mm
- 3 chaves macho sextavadas \odot 4 - 5 - 6 mm
- 1 Chave ajustável 250 mm
- 13 chaves de caixa sextavadas, quadra de 1/2" \odot 8÷17 - 19 - 22 - 24 mm
- 1 extensão com quadras macho e fêmea de 1/2" 125 mm
- 1 extensão com quadras macho e fêmea de 1/2" 255 mm
- 1 cardan com quadras macho e fêmea de 1/2"
- 1 cabo T corrediço, quadra de 1/2"
- 1 roquete reversível, quadra de 1/2" \otimes
- 8 chaves tubulares hexagonal, série ligeira 6x7 - 8x9 - 10x11 - 12x13 - 14x15 - 16x17 - 18x19 - 20x22 mm
- 2 passadores para chaves tubulares
- 1 Alicate de charneira fechada 250 mm
- 1 alicate de pressão 240 mm
- 1 alicates de corte diagonal para serviços pesados, punhos anti-deslizantes com dupla camada em PVC, acabamento industrial \triangleleft 160 mm
- 1 tesoura de electricista
- 1 alicate combinado para trabalhos pesados, punhos com duplo revestimento PVC, acabamento industrial \equiv 180 mm
- 1 alicate de ponta semi-redondas com estrias, extra-longas, punhos com duplo revestimento PVC, acabamento industrial \bullet 160 mm
- 4 chaves para parafusos de perfil de fenda \bullet 3x75 - 4x100 - 5,5x150 - 6,5x150 mm
- 3 chave para parafusos de perfil Phillips® \oplus PH0x60 - PH1x80 - PH2x100 mm
- 1 martelo para mecânico, tipo alemão 400 g
- 1 fita métrica 5 m
- 1 serrote com folha de serra bi-metálica
- 1 almotolia plástica 150 cc
- 1 x-acto com lâmina divisível de 18 mm

Refa. Nr.
31
32
34
42
96/SC9
96T
111E
920A
920/21
920/22
920/25
920/42
920/55
935
940
1048VN
1052
1084G
1128BMX
1150G
1166G
1201E
1202E
1370
1692
1726
1754
1771

5915VU/3

€ 1.030,00 059151028

Sortido recomendado em combinação com C7 - C9 - C10 - C10S - C11 - CP15L - C16 - CP17 - CP17L - C19 - C19L - C20 - C20L

5915VU/4

jogo de 80 ferramentas

► Universais

Nr. Peças/Descrição

- 1 saca-troços Ø 4 mm
- 1 punção de bico Ø 4 mm
- 1 escopros planos 150 mm
- 15 chaves mistas, boca-luneta 6-7-8-9-10-11-12-13-14-15-16-17-19-22-24 mm
- 9 chaves macho hexagonal \odot 1,5+10 mm
- 1 Chave ajustável 250 mm
- 13 chaves de caixa sextavadas, quadra de 1/2" \odot 8+17 - 19 - 22 - 24 mm
- 1 extensão com quadras macho e fêmea de 1/2" 255 mm
- 1 cardan com quadras macho e fêmea de 1/2"
- 1 cabo T correção, quadra de 1/2"
- 1 roquete reversível, quadra de 1/2" \otimes
- 17 chaves cachimbo 6 faces 6+22 mm
- 1 alicate de charmeira fechada 250 mm
- 1 alicate de pressão 240 mm
- 1 alicates de corte diagonal para serviços pesados, punhos em bi-matéria, acabamento industrial \nlessgtr 160 mm
- 1 tesoura de electricista
- 1 alicate combinado para trabalhos pesados, punhos bi-material, acabamento industrial \equiv 180 mm
- 1 alicate de pontas semi-redondas com estrias, extra-longas, punhos bi-material, acabamento industrial \bullet 160 mm
- 4 chaves para parafusos de perfil de fenda \bullet 3x75 - 4x100 - 5,5x150 - 6,5x150 mm
- 3 chave para parafusos de perfil Phillips \oplus PH0x60 - PH1x80 - PH2x100 mm
- 1 martelo para mecânico tipo francês 32 mm
- 1 fita métrica 5 m
- 1 serrote com folha de serra bi-metálica
- 1 almotolia plástica 150 cc
- 1 x - acto com lâmina divisível de 18 mm

Refa. Nr.

- 31
- 32
- 34
- 42
- 96/SC9
- 111E
- 920A
- 920/22
- 920/25
- 920/42
- 920/55
- 932/S17
- 1048N
- 1052
- 1084GBM
- 1128BMX
- 1150GBM
- 1166GBM
- 1201E
- 1202E
- 1370F
- 1692
- 1726
- 1754
- 1771



€

5915VU/4 1.330,00 059151045

Sortido recomendado em combinação com C20 - C20L

5915VU/5

jogo de 111 ferramentas

► Utilização universal

Nr. Peças/Descrição

- 1 saca-troços Ø 4 mm
- 1 punção de bico Ø 4 mm
- 1 escopros planos 150 mm
- 17 chaves mistas, boca-luneta 6-7-8-9-10-11-12-13-14-15-16-17-18-19-20-21-22 mm
- 8 chaves de bocas 6x7-8x9-10x11-12x13-14x15-16x17-18x19-20x22 mm
- 9 chaves macho sextavadas com uma extremidade esférica cromadas \odot
- 1 Chave ajustável 250 mm
- 39 jogo com 11 chaves de caixa sextavadas, 20 pontas e 8 acessórios
- 13 jogo com 11 chaves de caixa e 2 acessórios
- 1 alicate de charmeira fechada 250 mm
- 1 alicate de pressão 240 mm
- 1 alicate de corte diagonal, punhos com duplo revestimento PVC, acabamento industrial \nlessgtr 160 mm
- 1 turquês para cofragens 220 mm
- 1 tesoura de electricista
- 1 alicate combinado para trabalhos pesados, punhos com duplo revestimento PVC, acabamento industrial \equiv 180 mm
- 1 alicate de ponta semi-redondas com estrias, extra-longas, punhos com duplo revestimento PVC, acabamento industrial \bullet 160 mm
- 4 chaves para parafusos de perfil de fenda \bullet 3x75 - 4x100 - 5,5x100 - 6,5x150 mm
- 3 chave para parafusos de perfil Phillips \oplus PH0x60 - PH1x80 - PH2x100 mm
- 1 martelo para mecânico, tipo alemão 300 g
- 1 martelo com batentes plásticos intermutáveis Ø 35 mm
- 1 fita métrica 3 m
- 1 limas perfis diversos
- 1 serrote com folha de serra bi-metálica 440 mm
- 1 x - acto com lâmina divisível de 18 mm 18 mm
- 1 lanterna de inspecção LED, em alumínio anodizado robusto

Refa. Nr.

- 31
- 32
- 34
- 42
- 55/S8
- 96BPC/SC9
- 111E
- 900/C11
- 920A/C11
- 1048N
- 1052
- 1082G
- 1098
- 1128BMX
- 1150G
- 1166G
- 1201E
- 1202E
- 1370
- 1390
- 1692/3
- 1719BMA8/M
- 1726
- 1771BM
- 1833XS/2



€

5915VU/5 1.300,00 059151046

Sortido recomendado em combinação com C12 - C41S - C41H - C42S - C42H

5915VU/AS

jogo de 68 ferramentas

► Utilização universal

Nr. Peças/Descrição

- 1 saca-troços Ø 4 mm
- 1 punção de bico Ø 4 mm
- 1 escopros planos 150 mm
- 13 chaves mistas, boca-luneta 1/4 - 5/16 - 3/8 - 7/16 - 1/2 - 9/16 - 5/8 - 11/16 - 3/4 - 13/16 - 7/8 - 15/16 - 1"
- 8 chaves de luneta curvatura profunda 1/4"±1"
- 9 ○ 3/64"±3/8"
- 1 Chave ajustável 250 mm
- 11 chaves de caixa bocas de 12 faces quadra de 1/2" ○ 3/8 - 7/16 - 1/2 - 9/16 - 5/8 - 11/16 - 3/4 - 13/16 - 7/8 - 15/16 - 1"
- 1 extensão com quadras macho e fêmea de 1/2" 125 mm
- 1 extensão com quadras macho e fêmea de 1/2" 255 mm
- 1 cardan com quadras macho e fêmea de 1/2"
- 1 cabo T correção, quadra de 1/2"
- 1 roquete reversível, quadra de 1/2" ⊕
- 1 alicate de charneira fechada 250 mm
- 1 alicate de pressão 240 mm
- 1 alicates de corte diagonal para serviços pesados, punhos em bi-matéria, acabamento industrial \llcorner 160 mm
- 1 tesoura de electricista
- 1 alicate combinado para trabalhos pesados, punhos bi-material, acabamento industrial \equiv 180 mm
- 1 alicate de pontas semi-redondas com estrias, extra-longas, punhos bi-material, acabamento industrial ● 160 mm
- 4 chaves para parafusos de perfil de fenda ● 3x75 - 4x100 - 5,5x150 - 6,5x150 mm
- 3 chave para parafusos de perfil Phillips® ⊕ PH0x60 - PH1x80 - PH2x100 mm
- 1 martelo para mecânico, tipo alemão 300 g
- 1 fita métrica 5 m
- 1 serrote com folha de serra bi-metálica
- 1 almotolia plástica 150 cc
- 1 x - acto com lâmina divisível de 18 mm

Refa. Nr.

- 31
- 32
- 34
- 42AS
- 90AS/8
- 96AS/SC9
- 111E
- 920AS
- 920/21
- 920/22
- 920/25
- 920/42
- 920/55
- 1048N
- 1052
- 1084GBM
- 1128BMX
- 1150GBM
- 1166GBM
- 1201E
- 1202E
- 1370
- 1692
- 1726
- 1754
- 1771

€ 

5915VU/AS 1.130,00 059151032

Sortido recomendado em combinação com C10 - C20 - C20L

5927VU/M

jogo 108 ferramentas em tabuleiro maleável

► Utilização universal

Nr. Peças/Descrição

- 16 chaves mistas, boca-luneta 6-7-8-9-10-11-12-13-14-15-16-17-18-19-21-22 mm
- 1 Alicates de corte diagonal para trabalhos pesados \llcorner 160 mm
- 9 chaves macho hexagonal ○ 1,5-2-2,5-3-4-5-6-8-10 mm
- 1 alicate de pontas semi-redondas extra-longas \equiv 180 mm
- 1 Alicates de pontas semi-redondas extralongas ● 160 mm
- 3 chaves para parafusos de perfil de fenda ● 3,5x100-5,5x150-6,5x150 mm
- 3 chave para parafusos de perfil Phillips® ⊕ PH0x3x60-PH1x4,5x80-PH2x6x100 mm
- 31 jogo de 30 pontas com porta pontas magnético de desengate rápido em caixa plástica ● ○ ⊕ ⊕ ⊕
- 1 alicate de charneira fechada 250 mm
- 1 martelo para mecânico, tipo alemão 300 mm
- 1 punção de bico 4 mm
- 1 buris 4 mm
- 13 chaves de caixa sextavadas, quadra de 1/4" ○ 4-4,5-5-5,5-6-7-8-9-10-11-12-13-14 mm
- 1 extensão, quadra 1/4" 150 mm
- 1 cardan com quadras macho e fêmea de 1/4"
- 1 extensão 1/4" com punho, série curta
- 1 cabo T correção, quadra de 1/4"
- 1 roquete reversível, quadra de 1/4" ⊕
- 16 chaves de caixa sextavadas, quadra de 1/2" ○ 10-11-12-13-14-15-16-17-18-19-21-22-24-27-30-32 mm
- 1 cardan com quadras macho e fêmea de 1/2"
- 1 extensões com quadras macho e fêmea - 1/2" 125 mm
- 1 cabo T correção, quadra de 1/4"
- 1 roquete reversível, quadra de 1/2" ⊕
- 1 chave de caixa porta-pontas com encaixe quadra fêmea

Refa. Nr. TR

- 42 MC10
- 1084BM MC10
- 96/SC9 MC10
- 1150BM MC10
- 1166BM MC10
- 1201E MC10
- 1202E MC10
- 860MIX/A31 MC20
- 1048N MC20
- 1370 MC20
- 32 MC20
- 36 MC20
- 900 MC20
- 900/21 MC20
- 900/25 MC20
- 900BG/30C MC20
- 900/42 MC20
- 900/55 MC20
- 920A MC20
- 920/25 MC20
- 920AN/125 MC20
- 900/42 MC20
- 920/55 MC20
- 895/1 MC20

€ 

5927VU/M 1.110,00 059271021

Sortido recomendado em combinação com RSC22 - C27S - RSC23 - RSC23C

5938U/2T

sortido de 210 ferramentas

► Utilização universal

Nr. Peças/Descrição

- 7 chaves para parafusos de perfil de fenda 2,5x50 - 3x75 - 3,5x100 - 4x125
5,5x100 - 5,5x150 - 6,5x150 mm
- 6 chave para parafusos de perfil Phillips® PH0x60-PH1x80-PH1x120-PH2x100-PH2x150-PH3x150 mm
- 7 chaves para parafusos de perfil Torx®, com punho T6-T7-T8-T9-T10-T15-T20
- 1 alicates de freios interiores com pontas direitas 180 mm
- 1 alicates de freios interiores com pontas curvas 170 mm
- 1 alicates de freios exteriores com pontas direitas 175 mm
- 1 alicates de freios exteriores com pontas curvas 175 mm
- 1 alicate de charneira fechada 250 mm
- 1 alicate de pressão 240 mm
- 1 Alicates de corte diagonal para trabalhos pesados 160 mm
- 1 alicate de pontas semi-redondas extra-longas 180 mm
- 1 Alicates de pontas semi-redondas extralongas 160 mm
- 1 chave de caixa com sistema de roquete reversível 1/4x5/16
- 13 chaves de caixa sextavadas, quadra de 1/4" 4-4,5-5-5,5-6-7-8-9-10-11-12-13-14 mm
- 1 roquete reversível, quadra de 1/4" 125 mm
- 1 cabo T correção, quadra de 1/4" 115 mm
- 1 extensão com punho, quadra macho de 1/4" 176 mm
- 1 cardan com quadras macho e fêmea de 1/4" 41 mm
- 1 extensão, quadra 1/4" 150 mm
- 1 porta-pontas magnético com punho 230 mm
- 5 pontas para parafusos de perfil Spanner 4-6-8-10-12 mm
- 8 pontas para parafusos de perfil Torq-Set® 0-1-2-3-4-5-6-8 mm
- 6 pontas para parafusos de perfil Tri-Wing® 1-2-3-4-5-6 mm
- 8 pontas para parafusos de perfil Tamper Resistant Torx® T9-T10-T15-T20-T25-T27-T30-T40
- 11 pontas para aparafusadoras, para parafusos perfil Torx® T6-T7-T8-T9-T10-T15-T20-T25-T27-T30-T40
- 3 pontas para parafusos de perfil Pozidriv® Supadriv® PZ1 - PZ2 - PZ3
- 4 pontas para parafusos de perfil Phillips® PH0 - PH1 - PH2 - PH3
- 8 pontas macho hexagonal 2 - 2,5 - 3 - 4 - 5 - 6 - 8 - 10 mm
- 7 pontas para parafusos de fenda 0,5x3 - 0,6x4,5 - 0,8x5,5 - 1x5,5 - 1,2x6,5 - 1,2x8 - 1,6x8 mm
- 2 escopros planos 100 - 200 mm
- 1 martelo para mecânico, tipo alemão 300 g
- 1 martelo com batentes plásticos intermutáveis Ø 35 mm
- 1 fita métrica 5 m
- 1 mini serrote
- 1 10 lâminas divisível de 18 mm para x-acto ref. 1771, 1771BM, 1771HD
- 1 x - acto com lâmina divisível de 18 mm
- 19 chaves de caixa sextavadas, quadra de 1/2" 10 - 11 - 12-19 - 20 - 21 - 22 - 23 - 24 - 26 - 27 - 30 - 32 mm
- 5 chaves de caixa com ponta hexagonal, quadra de 1/2" 5 - 6 - 8 - 10 - 12 mm
- 1 extensão com quadras macho e fêmea de 1/2" 125 mm
- 1 extensão com quadras macho e fêmea de 1/2" 255 mm
- 1 cardan com quadras macho e fêmea de 1/2"
- 1 cabo T correção, quadra de 1/2"
- 1 roquete reversível, quadra de 1/2"
- 1 punção de bico Ø 4 mm
- 6 saca-troços com punho 2-3-4-5-6-8 mm
- 17 chaves mistas, boca-luneta 6-7-8-10-11-12-13-14-16-17-18-19-21-22-24-27-30 mm
- 8 chaves de bocas 6x7 - 8x9 - 10x11 - 12x13 - 14x15 - 16x17 - 18x19 - 20x22 mm
- 9 chaves macho hexagonal
- 6 chaves em T com três extremidades macho hexagonal 2,5 - 3 - 4 - 5 - 6 - 8 mm
- 5 limas perfis diversos 200 mm
- 11 chaves macho sextavadas 2 - 2,5 - 3 - 3,5 - 4 - 4,5 - 5 - 6 mm
- 4 tabuleiro em plástico para peças de pequenas dimensões, vazio
- 4 tabuleiro em plástico para peças de pequenas dimensões, vazio
- 4 tabuleiro em plástico para peças de pequenas dimensões, vazio

Refa. Nr.	TR
1201E	T211
1202E	T213
1207E/TX	T216
1032	T145
1034	T145
1036	T145
1038	T145
1048N	T153
1052	T153
1084BM	T137
1150BM	T137
1166BM	T137
194	T85
900	T85
900/55	T85
900/42	T85
900BG/30	T85
900/25	T85
900/21	T85
851SR	T85
861SP	T85
861TQS	T85
861TRW	T85
861RTX	T85
861TX	T85
861PZ	T85
861PH	T85
861PE	T85
861LP	T85
35	T234
1370	T234
1390	T234
1692	T294
1725CR	T294
1771RL	T294
920A	T80
920ME	T80
920/21	T80
920/22	T80
920/25	T80
920/42	T80
920/55	T80
32	T239
31BM	T239
42	T01
55	T33
96/SC9	T33
951	T68
1719BMA8/S5	T236
96T	T50
VP-3SC	VP-3SC
VP-LS	VP-LS
VP-LD	VP-LD

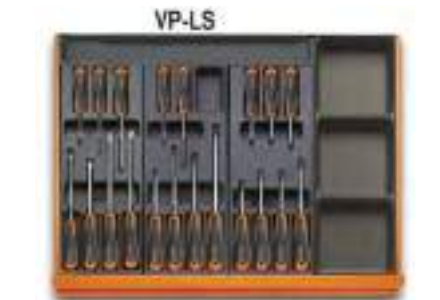

T211 T213 T216 VP3-SC
VP-LS



T145 T153 T137 VP3-SC
VP-LD



T85



T234 T294



T80 T239 VP3-SC
VP-LS



T01 T33 VP3-SC
VP-LD



T68 T236



T50

€

5938U/2T

2.750,00 059381062

Sortido recomendado em combinação com C38



5957U-P

sortido de 133 ferramentas

► Manutenção universal

Nr. Peças/Descrição	Refa. Nr.
6 saca-troços 2 + 8 mm	31/SP6
6 2 punções, 1 punção de bico e 3 escopros	38/SP6
17 chaves mistas 6+22 - 24 - 27 - 30 mm	42/S17X
12 chaves de bocas 6x7 + 30x32 mm	55/S12X
8 chaves macho hexagonal 2 + 10 mm	96T/S8
8 T9 + T40	97TX/SC8
1 Chave ajustável 250 mm	111E
13 chaves de caixa sextavadas, quadra de 1/2" 10 + 22 mm	920A/SB13
8 chaves de caixa sextavadas, quadra de 1/2" 23 + 32 mm	920A/SB8
7 chaves de caixa com ponta de perfil Phillips®	920LH/SB7
1,2x65 - 1,2x8 - 1,6x9 - 2x12mm - PH1-PH2-PH3	
1 alicates de freios interiores com pontas direitas 180 mm	1032
1 alicates de freios interiores com pontas curvas 170 mm	1034
1 alicates de freios exteriores com pontas direitas 175 mm	1036
1 alicates de freios exteriores com pontas curvas 175 mm	1038
1 alicate de charneira fechada 250 mm	1048N
1 alicate de pressão 240 mm	1052
1 tesoura modelo americano 250 mm	1112
1 tesoura de electricista	1128BMX
8 2,5x50 - 3x75 - 4x100 - 5,5x125 - 6,5x150 - PH0 - PH1 - PH2	1263/D8
2 martelo para mecânico, tipo alemão 300 - 600 g	1370
1 martelo com batentes plásticos intermutáveis 35	1390
1 fita métrica 5 m	1692/5
1 pesca-peças magnético	1712E/2
1 rascador curvo 200 mm	1717A
1 rascador triangular 200 mm	1717B
5 limas perfis diversos 200 mm	1719BMA8/S5
1 Lata de óleo de pressão 200 cc	1751N
1 x - acto com lâmina divisível de 18 mm	1771BM
1 extensão com quadras macho e fêmea de 1/2" 125 mm	920/21
1 extensão com quadras macho e fêmea de 1/2" 250 mm	920/22
1 cardan com quadras macho e fêmea de 1/2"	920/25
1 cabo T corredeço, quadra de 1/2"	920/42
1 roquete reversível, quadra de 1/2"	920/55
1 alavanca com extremidades chata e pontiaguda	963
1 Alicates de corte diagonal 160 mm	1082BM
1 Alicates de corte diagonal para trabalhos pesados 160 mm	1084BM
1 alicate de corte frontal, articulado, serviço pesado, grande esforço 180 mm	1092V
1 alicate de pontas semi-redondas extra-longas 180 mm	1150BM
1 Alicates de pontas semi-redondas extralongas 160 mm	1166BM
1 Alicates de pontas curvas semirredondas extralongas 160 mm	1168BM
2 chaves para parafusos de perfil de fenda 8x200 - 10x200 mm	1260
1 chaves para parafusos de perfil Phillips® PH3 8x150mm	1262
1 paquímetro	1650
1 serrote com folha de serra bi-metálica 420 mm	1725

€

5957U-P 2.870,00 059571004

Sortido recomendado em combinação com C57S A - C57S B - C57SP - RSC50 PS - RSC50 - C55PS - C55PSE - RSC55



5958U

jogo de 85 ferramentas

► Universais

Nr. Peças/Descrição	Refa. Nr.
17 chaves mistas, boca-luneta 6÷22 mm	42
12 chaves macho sextavadas \odot 2÷10 mm	96N/SC12
13 chaves de caixa sextavadas, quadra de 1/2" \odot 10÷22 mm	920A/SB13
8 chaves de caixa sextavadas, quadra de 1/2" \odot 23÷32 mm	920A/SB8
1 extensão com quadras macho e fêmea de 1/2" 125 mm	920/21
1 extensão com quadras macho e fêmea de 1/2" 255 mm	920/22
1 cardan com quadras macho e fêmea de 1/2"	920/25
1 cabo T corrediço, quadra de 1/2"	920/42
1 roquete reversível, quadra de 1/2" \oplus	920/55
1 alicates de freios interiores com pontas direitas \odot 180 mm	1032
1 alicates de freios exteriores com pontas direitas \bullet 175 mm	1036
1 alicate de charneira fechada 250 mm	1048N
1 alicate de pressão 240 mm	1052
1 Alicates de corte diagonal para trabalhos pesados ∇ 160 mm	1084BM
1 tesoura de electricista	1128BMX
1 alicate de pontas semi-redondas extra-longas \equiv 180 mm	1150BM
1 Alicates de pontas semi-redondas extralongas \bullet 160 mm	1166BM
7 chaves para parafusos de perfil de fenda \bullet 3x75 - 3,5x100 - 4x125 5,5x150 - 6,5x150 - 8x200 - 10x200 mm	1260
4 chaves para parafusos de perfil Phillips® \oplus PH0x60 - PH1x80 PH2x100 - PH3x150 mm	1262/S4
1 martelo para mecânico, tipo alemão 300 g	1370
1 martelo com batentes plásticos intermutáveis \varnothing 35 mm	1390
1 fita métrica 5 m	1692
5 jogo de 5 limas meia-murça, com punhos 200 mm	1719BMA...S5
1 serrote com folha de serra bi-metálica	1725
1 almotolia plástica 150 cc	1754
1 x - acto com lâmina divisível de 18 mm	1771

€ 

5958U 1.450,00 059581008

Sortido recomendado em combinação com C58P - C45PRO - RSC50 - RSC55



5990V1

jogo de 44 ferramentas para o estojo COMBO C99V1, em tabuleiro de espuma EVA

► Utilização universal

Nr. Peças/Descrição

- 9 chaves macho sextavadas com uma extremidade esférica cromadas ○
- 1 x - acto com lâmina divisível de 18 mm 18 mm
- 1 alicate de charneira fechada 250 mm
- 6 jogo de 2 punções, 1 punção de bico, 2 escopros planos e 1 bunitil em bolsa de poliéster
- 3 chaves para parafusos de perfil de fenda ● 3,5x100-5,5x125-6,5x150 mm
- 3 chaves para parafusos de perfil Phillips® ● PH0x60-PH1x80-PH2x100 mm
- 1 tesoura de electricista
- 16 chaves mistas, boca-luneta 6-7-8-9-10-11-12-13-14-15-16-17-18-19-21-22 mm
- 1 fita métrica 5 mt
- 1 martelo para mecânico, tipo alemão 300 g
- 1 alicate de corte diagonal, punhos bi-material, acabamento industrial ≡ 160 mm
- 1 alicate combinado para trabalhos pesados, punhos bi-material, acabamento industrial ≡ 180 mm

Refa. Nr.

- 96BPC/SC9 1771
- 1048N 1048N
- 38/B6N 38/B6N
- 1260 1260
- 1262 1262
- 1128BMX 1128BMX
- 42 42
- 1692/5 1692/5
- 1370 1370
- 1082GBM 1082GBM
- 1150GBM 1150GBM

€

5990V1 670,00 059900001

Jogo recomendado em combinação com C99V1



5990V3

jogo de 116 ferramentas para o estojo COMBO C99V3/2C, em tabuleiro de espuma EVA

► Reparação automóvel

Nr. Peças/Descrição

- 5 chaves macho hexagonal
- 1 Chave ajustável 250 mm
- 1 extensão com punho, quadra macho de 1/4"
- 1 busca - pólos ●
- 1 nível de bolso com base magnética em V
- 1 lanterna de inspeção LED, em alumínio anodizado robusto
- 31 jogo de 30 pontas com porta pontas magnético de desengate rápido em caixa plástica ● ○ ⊕ ⊕ ⊕ ⊕
- 1 chave de caixa porta-pontas com encaixe quadra fêmea
- 12 chaves de caixa sextavadas, quadra de 1/4" ○ 4-4,5-5-5,5-6-7-8-9-10-11-12-13 mm
- 1 extensão, quadra 1/4" 50 mm
- 1 extensão, quadra 1/4" 100 mm
- 1 cabo T corrediço, quadra de 1/4"
- 1 roquete reversível com quadra de 1/4", 72 dentes ⊕
- 38 punho para micro-chaves com 36 pontas intermutáveis de 4 mm e extensão magnética
- 1 martelo com batentes plásticos intermutáveis Ø 35mm
- 1 cardan com quadras macho e fêmea de 1/4"
- 13 chaves de caixa sextavadas, quadra de 1/2" ○ 10-11-12-13-14-15-16-17-18-19-20-21-22 mm
- 1 extensão com quadras macho e fêmea de 1/2" 125 mm
- 1 extensão com quadras macho e fêmea de 1/2" 255 mm
- 1 cardan com quadras macho e fêmea de 1/2"
- 1 cabo T corrediço, quadra de 1/2"
- 1 roquete reversível, quadra de 1/2" ⊕

Refa. Nr.

- 96T/S5P 96T/S5P
- 111E 111E
- 900BG/30 900BG/30
- 1253 1253
- 1695XS 1695XS
- 1833XS/2 1833XS/2
- 860MIX/A31 860MIX/A31
- 895 895
- 900 900
- 900/20 900/20
- 900/20L 900/20L
- 900/42 900/42
- 900/55Z 900/55Z
- 1256/C36-2 1256/C36-2
- 1390 1390
- 900/25 900/25
- 920A 920A
- 920/21 920/21
- 920/22 920/22
- 920/25 920/25
- 920/42 920/42
- 920/55 920/55

€

5990V3 965,00 059900003

Jogo recomendado em combinação com C99V3/2C



5980U/BIKE

Sortido de 90 ferramentas

► Reparação de bicicletas

Nr. Peças/Descrição	Refa. Nr.
5 chaves mistas, boca-luneta 8-9-10-13-14 mm	42
9 chaves macho hexagonal com uma extremidade esférica, brunidas	96BP/SC9
1,5-2-2,5-3-4-5-6-8-10 mm	
8 chaves macho hexagonal 2-2,5-3-4-5-6-8-10 mm	96T/S8
8 chaves para parafusos de perfil Torx®	97TTX/S8
○ T8-T10-T15-T20-T25-T27-T30-T40	
1 Chaves ajustáveis de grande abertura, cromadas, série curta 170 mm	111CM
1 corta - tubos para cobre e ligas leves	334
1 chaves dinamométricas 2+10 Nm	605E
13 ○ 4-4,5-5-5,5-6-7-8-9-10-11-12-13-14 mm	900/SB13
1 extensão, quadra 1/4"	900/21
1 cardan com quadras macho e fêmea de 1/4"	900/25
1 roquete reversível, quadra de 1/4" Ⓢ	900/55
1 alicate de corte diagonal, punhos com duplo revestimento PVC, acabamento industrial ⚡ 160 mm	1082G
1 tesoura de electricista 145 mm	1128BM
1 alicate combinado para trabalhos pesados, punhos com duplo revestimento PVC, acabamento industrial = 180 mm	1150G
1 alicate de ponta semi-redondas com estrias, extra-longas, punhos com duplo revestimento PVC, acabamento industrial ● 180 mm	1166G
7 3x75-4x125-5,5x150-6,5x150-PH0x60-PH1x80-PH2x100 mm	1203E/D
1 martelo para mecânico, tipo alemão 300 g	1370
1 martelo com batentes plásticos intermutáveis Ø 35 mm	1390
1 paquímetro 150 mm	1650
1 fita métrica 3 m	1692/3
1 limas chatas meia-murças, com punho 200 mm	1719BMA...P
1 limas meia-cana meia-murças, com punho 200 mm	1719BMA...M
1 limas redondas meia-murças, com punho 200 mm	1719BMA...R
1 serrote com folha de serra bi-metálica 300 mm	1725
1 x - acto com lâmina divisível de 18 mm	1771
1 ferramenta de verificação do desgaste das correntes 120 mm	3935
1 alicate para elos de correntes 170 mm	3937
7 sortido de 7 chaves de cones simples 13-14-15-16-17-18-19 mm	3952/S7
1 chave de boca para pedais 15 mm	3953
1 chave para raios, preta, 3,2 mm □	3961 3,2
1 chave para raios, verde, 3,3 mm □	3961 3,3
1 chave para raios, vermelha, 3,5 mm □ 3	3961 3,5
1 chave múltipla para raios, 3,2 - 4,0 mm □ 3,2 - 4,0 mm	3961U
1 ferramenta de bloqueio da cremalheira 289 mm	3967
1 alavanca metálica de pneus 200 mm	3969
3 kit de 3 alavancas de plástico, para pneus 113 mm	3969K3
1 alavanca para os freios do disco de travão 222 mm	3991
1 alinhador de discos de travão 234 mm	3992

€

5980U/BIKE 1.720,00 059801040

Sortido recomendado para usar com os itens C57S A - C57S B - C57SP - C55PSP

5980U/BIKE-M

jogo de 106 ferramentas para reparação e manutenção de bicicletas

► Reparação de bicicletas



M05 M50 M55



M137 M234 M236 M294



M213



M400



M401

Nr. Peças/Descrição

- 16 chaves mistas 6-7-8-9-10-11-12-13-14-15-16-17-18-19-20-21 mm
- 8 chaves macho sextavadas 2-2,5-3-4-5-6-7-8 mm
- 5 chaves para parafusos de perfil Torx® TX10-TX15-TX20-TX25-TX30
- 1 Alicates de corte diagonal para trabalhos pesados 160 mm
- 1 alicate de pontas semi-redondas extra-longas 160 mm
- 1 Alicates de pontas semirredondas extralongas 160 mm
- 6 chaves para parafusos de perfil de fenda 2,5x50-3x75-4x100-5,5x125-6,5x150-8x200 mm
- 1 chave para parafusos de perfil de fenda, série extra curta 4x30 mm
- 4 chave para parafusos de perfil Phillips® PH0x60-PH1x80-PH2x100-PH3x150 mm
- 1 chave para parafusos de perfil Phillips®, série extra curta 4,5x30 mm
- 12 chaves para parafusos de perfil Torx®, com punho TX6-TX7-TX8-TX9-TX10-TX15-TX20-T25-TX27-TX30-TX40-TX45
- 1 busca - pólos
- 1 martelo para mecânico, tipo alemão 300 g
- 1 martelo com batentes plásticos intermutáveis 35 mm
- 2 escopros planos 100-200 mm
- 1 jogo de 5 limas meia-murça, com punhos 200 mm
- 1 fita métrica 5 m
- 1 mini serrote 250 mm
- 1 x - acto com lâmina divisível de 18 mm
- 1 10 lâminas divisível de 18 mm para x-acto refª. 1771, 1771BM, 1771HD
- 1 Ferramenta para correntes compatível com correntes de 5 a 11 velocidades
- 1 ferramenta de verificação do desgaste das correntes
- 1 alicate para elos de correntes
- 7 13-14-15-16-17-18-19 mm
- 1 chave para raios, preta, 3,2 mm 3,2 mm
- 1 chave para raios, verde, 3,3 mm 3,3 mm
- 1 chave para raios, vermelha, 3,5 mm 3,5 mm
- 1 chave múltipla para raios, 3,2 - 4,0 mm 3,2-4,0 mm
- 1 alavanca metálica de pneus
- 1 kit de 3 alavancas de plástico, para pneus
- 1 Chave de extração do eixo de tração com 16 entalhes 39 mm
- 1 Chave de extração do eixo de tração com 16 entalhes 41 mm
- 1 Chave de extração do eixo de tração com 16 entalhes 46 mm
- 1 Chave extração do eixo de tração com 20 entalhes, com pino central, niquelada 31,5 mm
- 1 Chave de extração de cremalheira BMX, 4 pinos 35 mm
- 1 Chave de extração de cremalheira Shimano 22,8 mm
- 1 Chave de extração de cremalheira Shimano, cassete com pino guia 23,5 mm
- 1 Chave de extração de cremalheira Campagnolo, com pino guia 23 mm
- 1 alavanca para os freios do disco de travão
- 1 alinhador de discos de travão
- 1 Calibrador do suporte de mudanças
- 1 Extrator do crenque/braço do pedal
- 1 chave de boca para pedais
- 2 30x32-32x36 mm
- 1 ferramenta de bloqueio da cremalheira
- 1 Chave para parafusos de plástico Shimano

Refa. Nr.	TR
42	M05
96T	M50
97TTX	M55
1084	M137
1150	M137
1166	M137
1201E	M213
1201EN	M213
1202E	M213
1202EN	M213
1207E/TX	M213
1253	M213
1370	M234
1390	M234
35	M234
1719BMA...S5	M236
1692	M294
1725CR	M294
1771	M294
1771RL	M294
3932U	M400
3935	M400
3937	M400
3952	M400
3961 3.2	M400
3961 3.3	M400
3961 3.5	M400
3961U	M400
3969	M400
3969K3	M400
3973/1	M400
3973/2	M400
3973/3	M400
3973/4	M400
3984/1	M400
3984/2	M400
3984/3	M400
3984/4	M400
3991	M400
3992	M400
3921	M401
3948	M401
3953	M401
3955	M401
3967	M401
3971	M401

€

5980U/BIKE-M 2.230,00 059801050

Sortido recomendado para usar com os itens RSC23T - RSC24 6-7-8 - RSC24A 6-7-8 - RSC24AXL - RSC24AXLP/7 - RSC24L/7 - RSC24L-CAB RSC28 - C37 6-7-8 - C39 6-7-8 - C39MD - C39SM - RSC55 - RSC50 - C59

5988H/7M

Sortido de 333 ferramentas em tabuleiro maleável

► Reparação automóvel

Nr. Peças/Descrição

- 13  8-9-10-11-12-13-14-15-16-17-19-21-22 mm
- 16 chaves de caixa série longa, boca hexagonal  10-12-13-14-15-16-17-18-19-21-22-23-24-27-30-32 mm
- 7 chaves de caixa com quadra fêmea de 1/2", para parafusos com perfil Torx*  E12-E14-E16-E18-E20-E22-E24
- 10 chave de caixa com ponta macho sextavada  5-6-6L-7-8-8L-10-10L-12-12L mm
- 13 chaves de caixa com ponta macho de perfil Torx*  1/2"  T20-T25-T27-T30-T30L-T40-T40L-T45-T50-T50L-T55-T60-T60L
- 8 chaves de caixa com ponta macho de perfil XZN*  5-6-6L-8-8L-10-10L-12L mm
- 18 chaves mistas, boca-luneta 6-7-8-9-10-11-12-13-14-15-16-17-18-19-21-22-24-27 mm
- 7 chaves de luneta curvatura profunda 6x7-8x9-10x11-12x13-14x15-16x17-18x19 mm
- 1 adaptador de desengate rápido, 1/4", para chaves de roquete, 10mm
- 1 adaptador de desengate rápido, 3/8", para chaves de roquete, 13mm
- 1 adaptador de desengate rápido, 1/2", para chaves de roquete, 19mm
- 12 chaves boca/luneta com sistema de roquete 8-9-10-11-12-13-14-15-16-17-18-19 mm
- 9 chaves macho sextavadas com uma extremidade esférica cromadas  1,5-2-2,5-3-4-5-6-8-10 mm
- 1 chave de caixa porta-pontas com encaixe quadra fêmea  1/4- 1/4
- 1 chave de caixa porta-pontas com encaixe quadra fêmea  1/4- 3/8
- 1 chave de caixa porta-pontas com encaixe quadra fêmea  5/16- 1/2
- 13 chaves de caixa sextavadas, quadra de 1/4"  4-4,5-5-5,5-6-7-8-9-10-11-12-13-14 mm
- 9 chaves de caixa série longa, boca sextavadas  5-6-7-8-9-10-11-12-13 mm
- 4 chaves de caixa com ponta de perfil de fenda  0,8x4-1x5,5-1,2x6,51,2x8 mm
- 5 chaves de caixa com ponta sextavadas, quadra de 1/4"  3-4-5-6-7 mm
- 4 chaves de caixa com ponta de perfil Phillips*  PH1-PH2-PH3-PH4
- 7 chaves de caixa com ponta macho de perfil Torx*  T10-T15-T20-T25-T27-T30-T40
- 1 adaptador quadra fêmea de 1/4" para quadra macho de 3/8"  1/4- 3/8
- 3 extensão, quadra 1/4" 50-100-150 mm
- 1 cardan com quadras macho e fêmea de 1/4"
- 1 cabo T correção, quadra de 1/4"
- 1 roquete reversível, quadra de 1/4" 
- 1 extensão com punho, quadra macho de 1/4"
- 17 chaves de caixa, boca sextavadas 3/8"  6-7-8-9-10-11-12-13-14-15-16-17-18-19-20-21-22 mm
- 1 redução quadra fêmea de 3/8" para quadra macho de 1/4"  3/8- 1/4
- 1 adaptador, chaves quadra 1/2" fêmea e 3/8" macho  3/8- 1/2
- 1 extensões com quadras macho e fêmea - 3/8" 125 mm
- 1 extensões com quadras macho e fêmea - 3/8" 250 mm
- 1 cardan com quadras macho e fêmea de 3/8"
- 1 cabo T correção, quadra de 3/8"
- 1 roquete reversível, quadra de 3/8" 72 dentes 
- 21 chaves de caixa sextavadas, quadra de 1/2"  8-10-11-12-13-4-15-16-17-18-19-20-21-22-23-24-26-27-28-30-32 mm
- 2 extensões com quadras macho e fêmea - 1/2" 125-250 mm
- 1 redução quadra fêmea de 1/2" para quadra macho de 3/8"  1/2- 3/8
- 1 cardan com quadras macho e fêmea de 1/2"
- 1 cabo T correção, quadra de 1/2"
- 1 roquete reversível, quadra de 1/2" 
- 3 chaves de caixa 3/8" para velas  16-17,8-20,8 mm
- 31 jogo de 30 pontas com porta pontas magnético de desengate rápido em caixa plástica     
- 1 alicate de charneira fechada 250 mm
- 1 Alicates de corte diagonal  160 mm
- 1 alicate de pontas semi-redondas extra-longas  180 mm
- 1 Alicates de pontas chatas extralongas  160 mm
- 5 chaves para parafusos de perfil Phillips*  3x75-4x100-5,5x100-6,5x150-8x150 mm
- 1 chave para parafusos de perfil de fenda série curta  6,5x30 mm
- 3 chaves para parafusos de perfil Phillips*  PH1-PH2-PH3
- 1 chave para parafusos de perfil Phillips* série curt  PH2
- 4 chaves para parafusos de perfil Torx*  T20-T25-T27-T30
- 6 saca-troços 2-3-4-5-6-8 mm
- 1 punção de bico 4 mm
- 3 escopros planos 125-150-75 mm
- 1 buris 125 mm
- 2 martelo para mecânico, tipo alemão 500-1000 g
- 1 lman telescópico com cabeça flexível
- 1 martelo com batentes plásticos intermutáveis Ø 35 mm
- 1 fita métrica 5 m
- 1 alicates de freios interiores com pontas direitas  180 mm
- 1 alicates de freios interiores com pontas curvas  170 mm
- 1 alicates de freios exteriores com pontas direitas  175 mm
- 1 alicates de freios exteriores com pontas curvas  175 mm
- 1 alicate de pontas semi - redondas longas, brunido punhos bi - material  140 mm
- 1 alicate de corte diagonal  125 mm
- 4 micro-chaves para parafusos de perfil de fenda  2,0-2,5-3,0-3,5 mm
- 2 micro-chaves para parafusos de perfil Philips*  0-00
- 9 chaves para parafusos de perfil Torx*  T10-T15-T20-T25-T27-T30-T40-T45-T50
- 1 alicate de pressão 240 mm
- 1 alicates de pressão bicos longos 175 mm
- 1 alicate para oclusão de tubos plásticos
- 1 alicate para oclusão de tubos plásticos
- 1 paquímetro
- 1 apalpa - folgas
- 1 raspador para embalagens
- 7 chave de caixa articulada 6x7-8x9-10x11-12x13-14x15-16x17-18x19 mm
- 1 cabo articulado com punho quadra de 1/2"
- 1 alavanca curva com punho 450 mm
- 1 espelho telescópico 670 mm
- 1 limas perfis diversos 200 mm
- 1 limas perfis diversos 200 mm
- 1 limas perfis diversos 200 mm
- 1 limas perfis diversos 200 mm
- 1 limas perfis diversos 200 mm
- 1 Escova de fios de aço

Refa. Nr.	TR
910AL	M125
920AL	M125
920FTX	M125
920PE	M125
920TX	M125
920XZN	M125
42	M25
90	M25
123Q1/4	M25
123Q3/8	M25
123Q1/2	M25
142	M25
96BPC/SC9	M105
895/1	M105
895/3	M105
895/6	M105
900	M105
900L	M105
900LP	M105
900ME	M105
900PH	M105
900TX	M105
900/16	M105
900...	M105
900/25	M105
900/42	M105
900/55	M105
900B/30	M105
910A	M105
910/15	M105
910/16	M105
910/21	M105
910/22	M105
910/25	M105
910/42	M105
920/55	M105
956E	M105
860MIX/A31	M166
1048N	M166
1082BM	M166
1150BM	M166
1162BM	M166
1290	M166
1290N	M166
1292	M166
1292N	M166
1297TX	M166
31	M231
32	M231
34	M231
36	M231
1370	M231
1712TF	M231
1390	M231
1692	M125
1032	M62
1034	M62
1036	M62
1038	M62
1177BM	M62
1188BM	M62
1257LP	M62
1257PH	M62
97TTX	M62
1052	M78
1058	M78
1481PL/A	M78
1481PL/B	M78
1481PL/C	M78
1650	M78
1708/20	M78
1716P	M78
80	M78
920/36A	M78
965	M78
1715	M231
1719BMA/8M	M231
1719BMA/8P	M231
1719BMA/8Q	M231
1719BMA/8R	M231
1719BMA/8T	M231
1737NX	M231

€ 

5988H/7M 5.900,00 059881087

Sortido recomendado para usar com os itens RSC24/8 - RSC24A/8 - RSC24A-XL - C37/8 - C39/8 - RSC28 - C59B - RSC50 C8 - C55C8 - C55M8

5988L/4M

sortido de 273 ferramentas em módulo soft

► Reparações automóveis

Nr. Peças/Descrição

- 13 chaves de caixa sextavadas, quadra de 1/4" ○ 4-4,5-5-5,5-6-7-8-9-10-11-12-13-14 mm
- 9 chaves de caixa série longa, boca sextavadas ○ 5-6-7-8-9-10-11-12-13 mm
- 9 chaves macho sextavadas com uma extremidade esférica cromadas
○ 1,5-2-2,5-3-4-5-6-8-10 mm
- 1 chave de caixa porta-pontas com encaixe quadra fêmea
- 1 chave de caixa porta-pontas com encaixe quadra fêmea
- 1 chave de caixa porta-pontas com encaixe quadra fêmea
- 5 chaves de caixa com ponta sextavadas, quadra de 1/4" ○ 3-4-5-6-7 mm
- 4 chaves de caixa com ponta de perfil de fenda ● 0,8x4-1x5,5-1,2x6,5-2x8 mm
- 4 chaves de caixa com ponta de perfil Phillips® ⚙ PH1-PH2-PH3-PH4
- 7 chaves de caixa com ponta macho de perfil Torx® ⚙ T10-T15-T20-T25-T27-T30-T40
- 1 adaptador quadra fêmea de 1/4" para quadra macho de 3/8" □ 1/4 - ■ 3/8
- 3 extensão, quadra 1/4" 50-100-150 mm
- 1 cardan com quadras macho e fêmea de 1/4"
- 1 extensão com punho, quadra macho de 1/4"
- 1 cabo T corrediço, quadra de 1/4"
- 1 roquete reversível, quadra de 1/4" ⚙
- 17 chaves de caixa, boca sextavadas 3/8"
○ 6-7-8-9-10-11-12-13-14-15-16-17-18-19-20-21-22 mm
- 1 redução quadra fêmea de 3/8" para quadra macho de 1/4" □ 3/8 - ■ 1/4
- 1 adaptador, chaves quadra 1/2" fêmea e 3/8" macho □ 3/8 - ■ 1/2
- 1 extensões com quadras macho e fêmea - 3/8" 125 mm
- 1 extensões com quadras macho e fêmea - 3/8" 250 mm
- 1 cardan com quadras macho e fêmea de 3/8"
- 1 cabo T corrediço, quadra de 3/8"
- 1 roquete reversível, quadra de 3/8" 72 dentes ⚙
- 17 chaves de caixa sextavadas, quadra de 1/2" ○ 8-10-11-12-13-14-15-16-17-18-19-20-21-22-23-24-26-27-28-30-32 mm
- 1 redução quadra fêmea de 1/2" para quadra macho de 3/8" □ 1/2 - ■ 3/8
- 1 cardan com quadras macho e fêmea de 3/8"
- 2 extensões com quadras macho e fêmea - 1/2" 125 - 250 mm
- 1 cabo T corrediço, quadra de 1/2"
- 1 roquete reversível, quadra de 1/2" ⚙
- 3 chaves de caixa 3/8" para velas ○ 16-17,8-20,8 mm
- 13 ○ 8-9-10-11-12-13-14-15-16-17-19-21-22 mm
- 10 chave de caixa com ponta macho sextavada ○ 5-6-6L-7-8-8L-10-10L-12-12L mm
- 7 chaves de caixa com quadra fêmea de 1/2", para parafusos com perfil Torx® ⚙ E12-E14-E16-E18-E20-E22-E24
- 13 chaves de caixa com ponta macho de perfil Torx® 1/2" ⚙ T20-T25-T27-T30-T30L-T40-T40L-T45-T50-T50L-T55-T60-T60L
- 8 chaves de caixa com ponta macho de perfil XZN® ○ 5-6-6L-8-8L-10-10L-12L mm
- 16 chaves de caixa série longa, boca hexagonal
○ 10-12-13-14-15-16-17-18-19-21-22-23-24-27-30-32 mm
- 1 fita métrica 5 m
- 18 chaves mistas, boca-luneta 6-7-8-9-10-11-12-13-14-15-16-17-18-19-21-22-24-27 mm
- 7 chaves de luneta curvatura profunda 6x7-8x9-10x11-12x13-14x15-16x17-18x19 mm
- 1 adaptador de desengate rápido, 1/4", para chaves de roquete, 10mm
- 1 adaptador de desengate rápido, 3/8", para chaves de roquete, 13mm
- 1 adaptador de desengate rápido, 1/2", para chaves de roquete, 19mm
- 12 chaves boca/luneta com sistema de roquete 8-9-10-11-12-13-14-15-16-17-18-19 mm
- 31 jogo de 30 pontas com porta pontas magnético de desengate rápido em caixa plástica ● ○ ⚙ ⚙ ⚙
- 1 alicate de charneira fechada 250 mm
- 1 Alicates de corte diagonal < 160 mm
- 1 alicate de pontas semi-redondas extra-longas = 180 mm
- 1 Alicates de pontas chatas extralongas = 160 mm
- 5 chaves para parafusos de perfil Phillips® ● 3x75-4x100-5,5x100-6,5x150-8x150 mm
- 1 chave para parafusos de perfil de fenda série curta ● 6,5x30 mm
- 3 chaves para parafusos de perfil Phillips® ⚙ 4,5x80-6x100-8x150 mm
- 1 chave para parafusos de perfil Phillips® série curt ⚙ 6x30 mm
- 4 chaves para parafusos de perfil Torx® ⚙ T20-T25-T27-T30

Refa. Nr.	TR
900	M105
900L	M105
96BPC/SC9	M105
895/1	M105
895/3	M105
895/6	M105
900ME	M105
900LP	M105
900PH	M105
900TX	M105
900/16	M105
900/...	M105
900/25	M105
900BG/30	M105
900/42	M105
900/55	M105
910A	M105
910/15	M105
910/16	M105
910/21	M105
910/22	M105
910/25	M105
910/42	M105
910/55	M105
920A	M105
920/15	M105
910/25	M105
920AN	M105
920/42	M105
920/55	M105
96E	M105
910AL	M125
920PE	M125
920FTX	M125
920TX	M125
920XZN	M125
920AL	M125
1692/5	M125
42	M25
90	M25
123Q1/4	M25
123Q3/8	M25
123Q1/2	M25
142	M25
860MIX/A31	M166
1048N	M166
1082BM	M166
1150BM	M166
1162BM	M166
1290	M166
1290N	M166
1292	M166
1292N	M166
1297TX	M166



M105



M125



M25



M166

5988L/4M

€ 4.160,00 059881088

Seleção recomendada em combinação com as referências RSC24 - RSC24A - RSC24A-XL - RSC24L - RSC24L/CAB - C37 - C39 - C39T - C39SM - C39MD - RSC50 - RSC55 - C59

5988U6/M

jogo de 214 ferramentas

► Utilização universal

Nr. Peças/Descrição

Nr. Peças/Descrição	Refa. Nr.	TR
22 chaves mistas, boca-luneta 6-7-8-9-10-11-12-13-14-15-16-17-18-19-20-21-22-24 27-30-32-36 mm	42	M01
11 chaves de bocas 6x7-8x9-10x11-12x13-14x15-16x17-18x19-20x22-21x23-24x27-30x32 mm	55	M30
11 chaves de luneta curvatura profunda 6x7-8x9-10x11-12x13-14x15-16x17-18x19-20x22-21x23-24x27-30x32 mm	90	M30
9 chaves macho sextavadas com uma extremidade esférica cromadas ○ 1,5-2-2,5-3-4-5-6-8-10 mm	96BPC/SC9	M30
6 chaves para parafusos de perfil de fenda ● 2,5x50-3x75-4x100-5,5x125-6,5x150-8x200 mm	1201E	M213
1 chave para parafusos de perfil de fenda, série extra curta ● 4x30 mm	1201EN	M213
4 chave para parafusos de perfil Phillips® ● PH0x60-PH1x80-PH2x100-PH3x150 mm	1202E	M213
1 chave para parafusos de perfil Phillips®, série extra curta ● PH1x30 mm	1202EN	M213
12 chaves para parafusos de perfil Torx®, com punho ○ T6-T7-T8-T9-T10-T15-T20-T25-T27-T30-T40-T45	1207E/TX	M213
1 busca - pólos ●	1253	M213
3 punções Ø 2-3-4 mm	30	M230
6 saca-troços Ø 2-3-4-5-6-8 mm	31	M230
1 punção de bico Ø 4 mm	32	M230
1 escopros planos 150 mm	34	M230
2 escopros planos 200-250 mm	35	M230
1 buris 125 mm	36	M230
1 martelo para mecânico, tipo alemão 500 g	1370	M230
1 martelo com batentes plásticos intermutáveis Ø 35 mm	1390	M230
1 fita métrica 3 m	1692	M230
1 lman telescópico com cabeça flexível	1712TF	M230
1 limas quadradas meia-murças, com punho 200 mm	1719BMA...Q	M230
1 limas triangulares meia-murças, com punho 200 mm	1719BMA...T	M230
1 limas chatas meia-murças, com punho 200 mm	1719BMA...P	M230
1 limas meia-cana meia-murças, com punho 200 mm	1719BMA...M	M230
1 limas redondas meia-murças, com punho 200 mm	1719BMA...R	M230
1 Escova de fios de aço	1737NX	M230
1 x - acto com lâmina divisível de 18 mm 18 mm	1771	M230
1 alicates de freios interiores com pontas direitas ○ 180 mm	1032	M129
1 alicates de freios interiores com pontas curvas ○ 170 mm	1034	M129
1 alicates de freios exteriores com pontas direitas ● 175 mm	1036	M129
1 alicates de freios exteriores com pontas curvas ● 175 mm	1038	M129
1 alicate de charneira fechada 250 mm	1048N	M129
1 alicate de pressão 240 mm	1052	M129
1 Alicates de corte diagonal ✂ 160 mm	1082BM	M129
1 turquês para cofragens 220 mm	1098	M129
1 tesoura modelo americano 250 mm	1112	M129
1 tesoura de electricista	1128BM	M129
1 alicate de pontas semi-redondas extra-longas = 180 mm	1150BM	M129
1 Alicates de pontas semi-redondas extralongas ● 160 mm	1166BM	M129
1 Alicates de pontas curvas semirredondas extralongas ● 160 mm	1168BM	M129
1 chave de caixa porta-pontas com encaixe quadra fêmea	895/1	M100
1 chave de caixa porta-pontas com encaixe quadra fêmea	895/3	M100
1 chave de caixa porta-pontas com encaixe quadra fêmea	895/6	M100
13 chaves de caixa sextavadas, quadra de 1/4" ○ 4-4,5-5-5,5-6-7-8-9-10-11-12-13-14 mm	900	M100
9 chaves de caixa série longa, boca sextavadas ○ 5-6-7-8-9-10-11-12-13 mm	900L	M100
5 chaves de caixa com ponta sextavadas, quadra de 1/4" ○ 3-4-5-6-7 mm	900ME	M100
4 chaves de caixa com ponta de perfil de fenda ● 0,8x4-1x5,5-1,2x6,5-1,2x8 mm	900LP	M100
4 chaves de caixa com ponta de perfil Phillips® ● PH1-PH2-PH3-PH4	900PH	M100
7 chaves de caixa com ponta macho de perfil Torx® ● T10-T15-T20-T25-T27-T30-T40	900TX	M100
1 extensão, quadra 1/4" 50 mm	900/20	M100
1 extensão, quadra 1/4" 100 mm	900/20L	M100
1 extensão, quadra 1/4" 150 mm	900/21	M100
1 cardan com quadras macho e fêmea de 1/4"	900/25	M100
1 extensão com punho, quadra macho de 1/4"	900BG/30	M100
1 cabo T correção, quadra de 1/4"	900/42	M100
1 roquete reversível, quadra de 1/4" ⊕	900/55	M100
21 chaves de caixa sextavadas, quadra de 1/2" ○ 8-10-11-12-13-14-15-16-17-18-19-20-21-22-23-24-26-27-28-30-32 mm	920A	M100
1 redução quadra fêmea de 1/2" para quadra macho de 3/8" 125 mm	920/15	M100
1 cardan com quadras macho e fêmea de 1/2" 250 mm	920/25	M100
1 extensões com quadras macho e fêmea - 1/2"	920AN/125	M100
1 extensões com quadras macho e fêmea - 1/2"	920AN/250	M100
1 cabo T correção, quadra de 1/2"	920/42	M100
1 roquete reversível, quadra de 1/2" ⊕	920/55	M100
8 chaves de caixa com quadra fêmea de 1/2", para parafusos com perfil Torx® ● 10-12-14-16-18-20-22-24 mm	920FTX	M100
11 chaves de caixa série longa, boca hexagonal ○ 10-12-13-14-15-16-17-18-19-21-22 mm	920AL	M100



M01



M30



M213



M230



M129

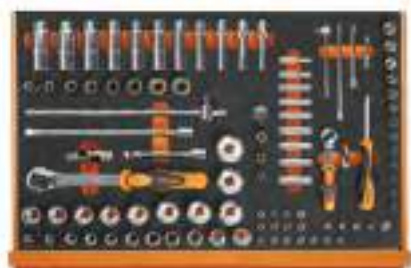

M100

€

5988U6/M 3.480,00 059881430

Sortido recomendado em combinação com RSC24 com 8 gavetas - RSC24/A com 8 gavetas - C37 com 8 gavetas - C39 com 8 gavetas RSC24A-XL - RSC28 - C39SM - C39MO - C59B - RSC50 - RSC55

5935ET/1MB

jogo de 96 ferramentas para caixa de ferramentas C35, em tabuleiros maleáveis

► Manutenção eletrotécnica

Nr. Peças/Descrição

- 1 alicate de pressão 240 mm
- 1 martelo para mecânico, tipo alemão 500 g
- 1 martelo com batentes plásticos intermutáveis Ø 35 mm
- 1 limas quadradas meia-murças, com punho 200 mm
- 1 limas chatas meia-murças, com punho 200 mm
- 1 limas triangulares meia-murças, com punho 200 mm
- 1 limas meia-cana meia-murças, com punho 200 mm
- 1 limas redondas meia-murças, com punho 200 mm
- 1 escopros planos 200 mm
- 1 alicates de freios interiores com pontas direitas ○ 180 mm
- 1 alicates de freios interiores com pontas curvas ○ 170 mm
- 1 alicates de freios exteriores com pontas direitas ● 175 mm
- 1 alicates de freios exteriores com pontas curvas ● 175 mm
- 1 Alicates de corte diagonal para trabalhos pesados † 160 mm
- 1 alicate de pontas semi-redondas extra-longas = 180 mm
- 1 Alicates de pontas semi-redondas extralongas ● 160 mm
- 9 chaves macho sextavadas com uma extremidade esférica cromadas ⊕
- 1 chave de fenda com guia preênsil ●
- 1 chave para parafusos de perfil Phillips® com guia preênsil ⊕
- 1 busca - pólos ●
- 6 chaves de caixa com punho ○ 5,5-6-7-8-10-13 mm
- 4 chaves para parafusos de perfil Phillips®, 1000V ⊕ PH0x60-PH1x80-PH2x100-PH3x150 mm
- 6 chaves para parafusos de fenda sem cabeça, 1000V
● 2,5x75-3x100-4x100-5,5x125-6x150-8x175 mm
- 31 jogo de 30 pontas com porta pontas magnético de desengate rápido em caixa plástica ● ○ ⊕ ⊕ ⊕ ⊕
- 1 porta bits magnético, isolado, com punho de 2 componentes ⊕
- 8 chaves de bocas 6x7-8x9-10x11-12x13-14x15
16x17-18x19-20x22 mm
- 1 Alicate ajustável, charneira fechada, isolado 250 mm
- 1 alicate de corte diagonal 1000V † 140 mm
- 1 tesoura de electricista, lâminas direitas, com perfis de escareação
- 1 alicate para cortar cabos de cobre e alumínio, com punhos isolados 230 mm
- 1 alicate de descarnar fio † 160 mm
- 1 alicates universais em cromado brilhante 1000V = 180 mm
- 1 alicate de pontas semi - redondas extra - longas, 1000V ● 160 mm
- 1 alicates de pontas curvas semi-redondas extra-longas ● 160 mm
- 1 chaves ajustável, 1000V 250 mm
- 1 navalha, 1000V
- 1 pinça de pontas curvas estriadas, 1000V
- 1 alicate para cravar terminais isolados série ligeira

Refa. Nr.	TR
1052	MB65
1370	MB65
1390	MB65
1719BMA...Q	MB65
1719BMA...P	MB65
1719BMA...T	MB65
1719BMA...M	MB65
1719BMA...R	MB65
35	MB65
1032	MB65
1034	MB65
1036	MB65
1038	MB65
1084BM	MB65
1150BM	MB65
1166BM	MB65
96BPCS9	MB63
1250	MB63
1251	MB63
1253	MB63
943MQ	MB63
1272MQ	MB63
1274MQ	MB63
860MIXA31	MB63
850MQ	MB63
55	MB64
1048MQ	MB64
1082MQ	MB64
1128BSX	MB64
1132MQ	MB64
1142MQ	MB64
1150MQ	MB64
1166MQ	MB64
1168MQ	MB64
110MQ	MB64
1777MQ	MB64
993MQ	MB64
1602	MB64



MB65



MB64



MB63

5935ET/1MB

€ 2.110,00 059351332

Sortido recomendado em combinação com C35



5980ET/A

jogo de 70 ferramentas

► Manutenção electrotécnica

Nr. Peças/Descrição	Refa. Nr.
1 punção de bico Ø 4 mm	32
1 escopros planos 150 mm	35
8 6x7 - 8x9 - 10x11 - 12x13 - 14x15 - 16x17 - 18x19 - 20x22 mm	55/B8N
8 Jogo de 8 chaves macho hexagonal, série longa Ø 2+10 mm	96LC/SC8
1 Chave ajustável 200 mm	111E
1 porta bits magnético, isolado, com punho de 2 componentes ®	850MQ
10 jogo de 10 pontas com porta pontas magnético em caixa plástica Ⓢ Ⓢ Ⓢ	860MIX/A10
1 Alicate ajustável, charneira fechada, isolado 250 mm	1048MQ
1 Alicates de corte diagonal 160 mm	1082BM
1 tesoura de electricista, lâminas direitas, com perfis de escareação	1128BSX
1 corta - cabos 170 mm	1132BM
1 alicate de pontas semi-redondas extra-longas ≡ 180 mm	1150BM
1 Alicates de pontas semi-redondas extralongas Ⓢ 160 mm	1166BM
1 Alicates de pontas curvas semirredondas extralongas Ⓢ 160 mm	1168BM
1 chave de fenda com guia preênsil Ⓢ 4x125 mm	1250
1 chave para parafusos de perfil Phillips®	1251
1 com guia preênsil Ⓢ PH1x125 mm	
1 busca - pólos Ⓢ	1253
5 chaves para parafusos de perfil de fenda Ⓢ 2,5x75 - 3,5x100 - 5,5x125 - 6,5x150 mm	1201E
1 chave para parafusos de perfil de fenda, série extra curta Ⓢ 4x30 mm	1201EN
4 chave para parafusos de perfil Phillips® Ⓢ PH0x60 - PH1x120 - PH2x150 - PH3x150 mm	1202E
1 chave para parafusos de perfil Phillips®, série extra curta Ⓢ PH2x30 mm	1202EN
4 chaves para parafusos de perfil Phillips®, 1000V Ⓢ PH0x60 - PH1x80 - PH2x100 - PH3x150 mm	1272MQ
5 chaves para parafusos de fenda sem cabeça, 1000V Ⓢ 5,5x125 - 3x100 - 4x100 - 6,5x150 - 8x175 mm	1274MQ
1 talhadeira chata com lâmina oblíqua	1343
1 martelo para mecânico, tipo alemão 300 g	1370
1 martelo com batentes plásticos intermutáveis Ø 35 mm	1390
1 alicate para cravar terminais isolados série ligeira	1602
1 25 m	BMESB1923NE
1 fita métrica 5 m	1692
1 limas meia-cana meia-murças, com punho 200 mm	1719BMA...M
1 limas redondas meia-murças, com punho 200 mm	1719BMA...R
1 serrote com folha de serra bi-metálica	1725
1 navalha com entalhe para descarnar	1777BM

€

5980ET/A 1.070,00 059801083

Sortido recomendado em combinação com C12 - 2028VV - 2032TV - 2032VV

5980ET/B

sortido de 64 ferramentas

► Manutenção electrotécnica

Nr. Peças/Descrição

Nr. Peças/Descrição	Refa. Nr.
3 saca-troços Ø 2 - 3 - 4 mm	31
1 punção de bico Ø 4 mm	32
1 escopros planos 150 mm	34
8 6x7 - 8x9 - 10x11 - 12x13 - 14x15 - 16x17 - 18x19 - 20x22 mm	55/B8N
9 chaves macho sextavadas com uma extremidade esférica cromadas Ø 1,5 - 2 - 2,5 - 3 - 4 - 5 - 6 - 8 - 10 mm	96BPC/SC9
1 rebarbador de lâmina giratória com lâmina intermutável 150 mm	345SB
6 chaves de caixa com punho de boca hexagonal com punho 1000V ○ 5,5 - 6 - 7 - 8 - 10 - 13 mm	943MQ/S6
1 alicate ajustável, charneira fechada, isolado 250 mm	1048MQ
1 alicate de corte diagonal 1000V ≧ 160 mm	1082MQ
1 tesoura de electricista, lâminas direitas, com perfis de escareação	1128BSX
1 alicate para cortar cabos de cobre e alumínio, com punhos isolados 230 mm	1132MQ
1 alicate de descarnar fio ≧ 160 mm	1142MQ
1 alicates universais em cromado brilhante 1000V ≡ 180 mm	1150MQ
1 alicate de pontas semi - redondas extra - longas, 1000V ● 160 mm	1166MQ
1 busca - pólos ●	1253
3 chaves para parafusos de perfil Phillips®, 1000V ⊕ PH0x60 - PH1x80 - PH2x100 mm	1272MQ
4 chaves para parafusos de fenda sem cabeça, 1000V ● 3x100 - 4x100 - 5,5x125 - 6,5x150 mm	1274MQ
1 martelo para mecânico, tipo alemão 300 g	1370
1 martelo com batentes plásticos intermutáveis Ø 35 mm	1390
1 alicate para cravar terminais isolados série ligeira	1602
1 réguas graduadas flexíveis em aço inoxidável 250 mm	1682
1 riscador, extremidades em carboneto de tungsténio 250 mm	1688
1 fita métrica 5 m	1692
1 nível com bolhas inquebráveis e corpo em perfil de alumínio anodizado 200 mm	1696
1 cinzeis para electricistas 10x200 mm	1701NE3
1 traçador de linhas em alumínio	1705
1 espelho quadrado 600 mm	1715FL/A
1 limas perfis diversos 200 mm	1719BMA8/M
1 limas perfis diversos 200 mm	1719BMA8/R
1 saca - molas	1723
1 serrote com folha de serra bi-metálica	1726BM
1 pincel	1738
1 alicate para abraçadeiras em Nylon	1743
1 almotolia plástica 150 cc	1754
100 abraçadeiras em nylon, cor preta resistente a UV 3,6x200 mm	1748N
100 abraçadeiras em nylon, cor preta resistente a UV 4,8x300 mm	1748N
1 x - acto com lâmina divisível de 18 mm	1771BM
1 ferro de soldar bivalente 30 W	1814M
1 lanterna de inspecção LED, em alumínio anodizado robusto	1833XS/2

€ 1.470,00 059801084

Sortido recomendado em combinação com C12 - 2029/VV - 2033P/VV - 2036TV

5980MQ

jogo de 46 ferramentas

► Manutenção electrotécnica

Nr. Peças/Descrição

Nr. Peças/Descrição	Refa. Nr.
7 chave de boca simples, 1000V 10 - 12 - 13 - 14 - 17 - 19 - 22 mm	52MQ
1 chaves ajustável, 1000V 250 mm	110MQ
6 chaves de caixa com punho ○ 5,5 - 6 - 7 - 8 - 10 - 13 mm	943MQ
4 chaves em T com três extremidades macho hexagonal ○ 4 - 5 - 6 - 8 mm	951MQ
1 pinça de pontas curvas estriadas, 1000V	993MQ
1 Alicate ajustável, charneira fechada, isolado 250 mm	1048MQ
1 alicate de corte diagonal 1000V ≧ 160 mm	1082MQ
1 tesoura de electricista	1128MQ
1 alicate de descarnar fio ≧ 160 mm	1142MQ
1 alicates universais em cromado brilhante 1000V ≡ 180 mm	1150MQ
1 alicate de pontas curvas chatas extra-longas ≡ 160 mm	1164MQ
1 alicate de pontas semi - redondas extra - longas, 1000V ● 160 mm	1166MQ
1 busca - pólos ●	1253
4 chaves para parafusos de perfil Phillips®, 1000V ⊕ PH0x60 - PH1x80 - PH2x100 - PH3x150 mm	1272MQ
5 chaves para parafusos de fenda sem cabeça, 1000V ● 3x100 - 4x100 - 5,5x125 - 6,5x150 - 8x175 mm	1274MQ
1 martelo para mecânico, tipo alemão 300 g	1370
1 martelo com batentes plásticos intermutáveis Ø 35 mm	1390
1 fita métrica 5 m	1692
1 200 mm	1701NE/3
1 mini serrote, 1000V	1725MQ
2 navalha, 1000V	1777MQ
1 ferro de soldar bivalente 30 W	1814M
1 lanterna LED de elevada luminosidade, em alumínio anodizado robusto, até 500 lumens	1833S
1 ferramenta de teste de tensão e continuidade, 12-690V AC/DC	1760PT

€ 1.990,00 059801257

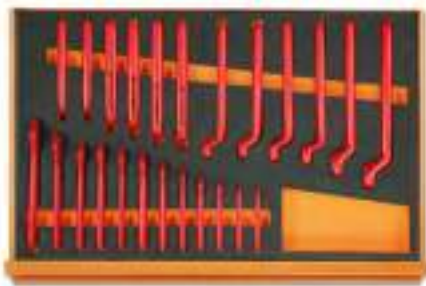

M49



M108



M161

5988 VHB-MQ

sortido de 66 ferramentas em módulos soft

► Manutenção eletrotécnica

Nr. Peças/Descrição

- 12 chave de boca simples, 1000V 7-8-10-11-12-13-14-15-16-17-19-22 mm
- 12 chaves de luneta 7-8-10-11-12-13-14-15-16-17-19-22 mm
- 4 chaves de caixa com ponta macho hexagonal \odot 4-5-6-8 mm
- 11 chaves de caixa bi-sextavadas \odot 7-8-10-11-12-13-14-15-16-17-19 mm
- 6 chaves de caixa de perfil Torx® \odot T15-T20-T25-T27-T30-T40
- 2 chaves de caixa de perfil XZN® \odot 8-10 mm
- 1 extensão quadra 3/8" 125 mm
- 1 extensão quadra 3/8" 250 mm
- 1 punho em T, encabadoiro 3/8"
- 1 roquete reversível quadra de 3/8"
- 1 tesoura de electricista
- 1 Alicate ajustável, charneira fechada, isolado 250 mm
- 1 alicate de corte diagonal 1000V ∇ 160 mm
- 1 alicates universais em cromado brilhante 1000V \equiv 180 mm
- 1 alicates de pontas extra-longas chatas \equiv 160 mm
- 1 alicate de pontas curvas chatas extra-longas \equiv 160 mm
- 4 chaves para parafusos de perfil Phillips®, 1000V \oplus PH0x60 - PH1x80 - PH2x100 - PH3x150 mm
- 4 chaves para parafusos de fenda sem cabeça, 1000V \bullet 2,5x75 - 3x100 - 4x100 - 5,5x125 mm
- 1 navalha de descarnar cabo, isolada

Refa. Nr.	TR
52MQ	M49
89MQ	M49
910MQ/PE	M108
910MQ/B	M108
910MQ/TX	M108
910MQ/XZN	M108
910MQ/21	M108
910MQ/22	M108
910MQ/T	M108
910MQ/55	M108
1128MQ	M161
1048MQ	M161
1082MQ	M161
1150MQ	M161
1162MQ	M161
1164MQ	M161
1272MQ	M161
1274MQ	M161
1777MQ/U	M161

€

5988 VHB-MQ 3.270,00 059880300

Seleção recomendada em combinação com as referências RSC51 - RSC23T - RSC24 - RSC24A - RSC24A-XL - RSC24L - RSC24L/CAB RSC28 - C37 - C39 - C39SM - C39MD - C39T - RSC55 - RSC50 - C59

5980EL/A

sortido de 57 ferramentas

► Electronics

Nr. Peças/Descrição

- 13 4÷14 mm
- 9 chaves macho hexagonal \odot 1,5÷10 mm
- 1 pinça de pontas finas, curvas e estriadas 130 mm
- 1 pinça com guia, pontas finas direitas e estriadas 150 mm
- 1 pinça cruzada de pontas largas, direitas e estriadas 155 mm
- 1 tesoura de electricista
- 1 alicate para descarnar fio ∇ 160 mm
- 1 Alicates de pontas semi-redondas extralongas \bullet 160 mm
- 1 alicate de pontas chatas longas \equiv
- 1 alicate de pontas semi - redondas longas curvas, brunido punhos bi - material \bullet
- 1 alicate universal \bullet
- 1 alicate de corte diagonal raso ∇
- 1 alicate de corte diagonal ∇
- 1 chave de fenda com guia preênsil \bullet 4x125 mm
- 1 chave para parafusos de perfil Phillips® com guia preênsil \oplus PH0x125 mm
- 8 micro-chaves
- 1 martelo para mecânico, tipo alemão 200 g
- 1 fita métrica 5 m
- 1 espelho telescópico
- 3 jogo de 3 limas
- 1 saca - molas
- 1 pincel
- 1 Oleador tipo caneta
- 1 x - acto com lâmina divisível de 18 mm
- 1 pinça de pontas redondas estriadas com bloqueio, em aço inoxidável
- 1 ferro de soldar bivalente 25 W
- 1 bomba de dessoldar
- 1 lanterna de inspecção LED, em alumínio anodizado robusto

Refa. Nr.
73/B13N
96N/SC9
991
992
998
1128BMX
1142BM
1166BM
1172BM
1178BM/P
1178BM
1185BM
1188BM
1250
1251
1257LPH/S8
1370
1692
1715
1720/S3
1723
1738
1756
1771
1002
1814M
1830T
1833XS/2

€

5980EL/A 1.060,00 059801081

Sortido recomendado em combinação com 2032TV - 2028/VV - 2033P/VV

5980EL/B

sortido de 98 ferramentas



► Electrónica

Nr. Peças/Descrição	Refa. Nr.
13 4÷14 mm	73/B13N
9 chaves macho hexagonal \odot 1,5÷10 mm	96/SC9
8 chaves macho para parafusos de cabeça Torx® \odot T9 - T10 - T15 - T20 - T25 - T27 - T30 - T40	97TX/BG8
1 Chave ajustável 150 mm	111E
18 jogo com 13 chaves hexagonais e 5 acessórios	900/C13-5
1 pinça de pontas finas, direitas e estriadas em aço inoxidável 130 mm	990
1 pinça de pontas finas, curvas e estriadas 130 mm	991
1 pinça com pontas curtas e arredondadas em aço inoxidável 120 mm	999A
1 tesoura de electricista	1128BMX
1 alicate para descarnar fio, com ajuste 170 mm	1149F
1 alicate de pontas semi-redondas extra-longas \equiv 180 mm	1150BM
1 alicate de pontas chatas longas \equiv 140 mm	1172BM
1 alicate de pontas semi - redondas longas, bruno punhos bi - material \bullet 140 mm	1177BM
1 alicate de pontas semi - redondas longas curvas, bruno punhos bi - material \bullet 140 mm	1178BM/P
1 alicate de corte diagonal, raso pontas redondas punhos bi - material \sphericalangle 120 mm	1184BM
1 alicate de corte diagonal, raso, pontas finas e estriadas punhos bi - material \sphericalangle 120 mm	1186BM
1 alicate de corte frontal oblíquo, raso punhos bi - material \sphericalangle	1191BM
8 micro-chaves	1257LPH/S8
1 busca - pólos \bullet	1253
1 chave para parafusos de perfil de fenda série curta \bullet 6,5x30 mm	1290N
3 chaves para parafusos de perfil Phillips® \oplus PH0x60 - PH1x80 - PH2x100 mm	1292
2 chave para parafusos de perfil Phillips® série curt \oplus PH1x30 - PH2x30 mm	1292N
5 chaves para parafusos de perfil de fenda sem cabeça \bullet 2,5x60 - 3x75 - 4x100 - 5x125 - 6,5x150 mm	1294
1 martelo para mecânico, tipo alemão 200 g	1370
1 régua graduada flexíveis em aço inoxidável 150 mm	1682
1 riscador, extremidades em carboneto de tungstênio 220 mm	1688
1 fita métrica 5 m	1692
1 espelho telescópico 670 mm	1715
1 Limas de calado \bullet	1720R
1 Limas de calado \blacktriangle	1720T
1 Limas de calado \blacksquare	1720P
1 saca - molas	1723
1 pincel	1738
1 Oleador tipo caneta	1756
1 x - acto com lâmina divisível de 18 mm	1771BM
1 navalha com entalhe para descarnar	1777BM
1 pinça de pontas redondas estriadas com bloqueio, em aço inoxidável	1002
1 ferro de soldar bivalente 25W	1814M
1 bomba de dessoldar	1830T
1 lanterna de inspecção LED, em alumínio anodizado robusto	1833XS/2



5980EL/B 1.490,00 059801082

Sortido recomendado em combinação com 2029/VV - 2033P/VV - 2036TV



5980ID/1

jogo de 24 ferramentas

► Canalização

Nr. Peças/Descrição	Refa. Nr.
1 Chave ajustável 250 mm	111E
1 Ø 3+28 mm	332/2
1 corta - tubos para cobre e ligas leves Ø 3+30 mm	334
1 Ø 0+42 mm	342
1 140 mm	345SB2
2 320-410 mm	376
2 alicate de charneira fechada 175-250 mm	1048N
1 tesoura de electricista	1128BMX
1 alicate combinado para trabalhos pesados, punhos bi-material, acabamento industrial = 180 mm	1150GBM
4 chaves para parafusos de perfil de fenda ● 3x75-4x100-5,5x150-8x150 mm	1201E
2 chave para parafusos de perfil Phillips® PH1x80-PH2x100	1202E
1 martelo para mecânico, tipo alemão 500 g	1370
1 fita métrica em fibra de vidro 2 m	1690F
1 fita métrica 5 m	1692/5
1 nível com bolhas inquebráveis e corpo em perfil de alumínio anodizado 200 mm	1696
1 limas meia-cana meia-murças, com punho 200 mm	1719BMA...M
1 Lima chata paralela 200 mm	1719BM/RL
1 serrote com folha de serra bi-metálica	1725

€



5980ID/1

620,00 059801086

Sortido recomendado para usar com os itens 2009N/BV - C4 - C5 - C5S - C6T - C9MT

Beta

5989 VEM

jogo de 81 ferramentas para reparação e manutenção de veículos híbridos e elétricos

► Reparação auto

Nr. Peças/Descrição

- 1 tapete isolante
- 4 postes de plástico com base de enchimento
- 1 Multímetro/megômetro para teste de isolamento de alta tensão. Indicador TRUE RMS
- 1 ferramenta de teste de tensão e continuidade, 12-690V AC/DC
- 1 Cabos de substituição para multímetros digitais e braçadeiras amperométricas
- 1 Luvas isolantes Gr. 10
- 1
- 1 corrente de barreira em plástico
- 2 sinais de alerta em alumínio A1, A2
- 2 sinais de proibição D2, D3
- 12 chave de boca simples, 1000V 7-8-10-11-12-13-14-15-16-17-19-22 mm
- 12 chaves de luneta 7-8-10-11-12-13-14-15-16-17-19-22 mm
- 4 chaves de caixa com ponta macho hexagonal \varnothing 4-5-6-8 mm
- 11 chaves de caixa bi-sextavadas \varnothing 7-8-10-11-12-13-14-15-16-17-19 mm
- 6 chaves de caixa de perfil Torx® \odot TX15-TX20-TX25-TX27-TX30-TX40
- 2 chaves de caixa de perfil XZN® \odot M8-M10
- 1 extensão quadra 3/8" 140 mm
- 1 extensão quadra 3/8" 265 mm
- 1 punho em T, encabadouro 3/8" 200 mm
- 1 roquete reversível quadra de 3/8" 203 mm
- 1 Alicate ajustável, charneira fechada, isolado 250 mm
- 1 alicate de corte diagonal 1000V \leq 160 mm
- 1 tesoura de electricista 145 mm
- 1 alicates universais em cromado brilhante 1000V \equiv 180 mm
- 1 alicates de pontas extra-longas chatas \equiv 160 mm
- 1 alicate de pontas curvas chatas extra-longas \equiv 160 mm
- 4 chaves para parafusos de perfil Phillips®, 1000V \oplus PH0-PH1-PH2-PH3
- 4 chaves para parafusos de fenda sem cabeça, 1000V \bullet 2,5x75-3x100-4x100-5.5x125 mm
- 1 navalha de descarnar cabo, isolada 190 mm

Refa. Nr.	TR
1995MQ/T	
7104 90	
1760/OHM	
1760PT	
1760DGT-R3	
1996MQ/GM	
1996VPG	
7105 6	
7109A	
7109D	
52MQ	M49
89MQ	M49
910MQ/PE	M108
910MQ/B	M108
910MQ/TX	M108
910MQ/XZN	M108
910MQ/21	M108
910MQ/22	M108
910MQ/T	M108
910MQ/55	M108
1048MQ	M161
1082MQ	M161
1128MQ	M161
1150MQ	M161
1162MQ	M161
1164MQ	M161
1272MQ	M161
1274MQ	M161
1777MQ/U	M161

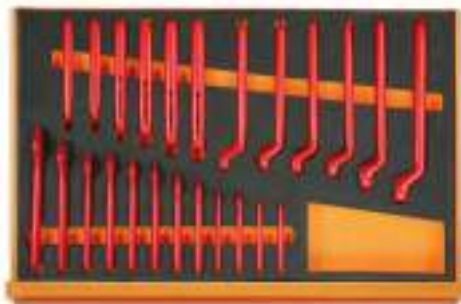

M49



M108



M161



5989 VEM

€ 5.650,00 059890116

Jogo recomendado em combinação com o artigo RSC24/6-R

5902MT

jogo de 106 ferramentas para agricultura, construção e máquinas de movimentação de terras

► Movimentação de terras

Nr. Peças/Descrição	Refa. Nr.
2 punções Ø 3 - 4 mm	30
2 saca-troços Ø 6 - 8 mm	31
1 punção de bico Ø 4 mm	32
2 escopros planos 150 - 200 mm	35
18 chaves mistas, boca-luneta 6+14 - 17 - 19 - 22 - 24 - 27 - 30 - 32 - 36 - 41 mm	42
10 chaves de luneta curvatura profunda 6x7 - 8x9 - 10x11 - 12x13 - 14x15 - 16x17 - 18x19 - 20x22 - 24x27 - 30x32 mm	90
10 chaves macho hexagonal \odot 1,5+12 mm	96NB10
17 chaves de caixa sextavadas, quadra de 1/2" \odot 10+22 - 24 - 27 - 30 - 32 mm	920A
1 extensão com quadras macho e fêmea de 1/2" 125 mm	920/21
1 extensão com quadras macho e fêmea de 1/2" 255 mm	920/22
1 cardan com quadras macho e fêmea de 1/2"	920/25
1 cabo T corredeço, quadra de 1/2"	920/42
1 roquete simples corredeço, quadra de 1/2" \otimes	920/50
11 chaves de caixa, quadra de 3/4" \odot 22 - 24 - 27 - 30 - 32 - 36 - 41 - 46 - 50 - 55 - 60 mm	928A
1 extensão com quadras macho e fêmea de 3/4" 200 mm	928/21
1 cabo articulado, quadra de 3/4"	928/36A
1 cabo T corredeço, quadra de 3/4"	928/42
1 roquete reversível, quadra de 3/4" \otimes	928/55
1 alavanca com extremidades pontiaguda e em cunha	964
1 alicate de charneira fechada 250 mm	1048N
1 alicate de pressão maxilas recurvadas	1055
1 alicates de corte diagonal para serviços pesados, punhos em bi-matéria, acabamento industrial ∇ 160 mm	1084GBM
1 tesoura de electricista	1128BMX
1 alicate combinado para trabalhos pesados, punhos bi-material, acabamento industrial \equiv 180 mm	1150GBM
1 alicate de pontas semi-redondas com estrias, extra-longas, punhos bi-material, acabamento industrial \bullet 160 mm	1166GBM
4 chaves para parafusos de perfil de fenda com sextavado auxiliar \bullet 6,5x150 - 8x175 - 10x200 - 12x250 mm	1260E
3 chaves para parafusos de perfil Phillips® com sextavado auxiliar \bullet PH2x150 - PH3x175 - PH4x200 mm	1262E
1 martelo com batente redondo e pena esférica 900 g	1377
1 martelo com batentes plásticos intermutáveis Ø 35 mm	1390
1 apalpa - folgas	1708/20
1 rascador triangular 200 mm	1717B
5 jogo de 5 limas meia-murça, com punhos 200 mm	1719BMA...S5
1 serrote com folha de serra bi-metálica	1725



€

5902MT 2.440,00 059021053

Sortido recomendado em combinação com RSC22 - RSC23 - RSC23C - C39T

5902MT/AS

jogo de 99 ferramentas para máquinas de movimentação de terras (CATERPILLAR)

► Movimentação de terras

Nr. Peças/Descrição	Refs. Nr.
2 punções Ø 3 - 4 mm	30
2 saca-troços Ø 6 - 8 mm	31
1 punção de bico Ø 4 mm	32
2 escopros planos 150 - 200 mm	35
20 chaves mistas, boca-luneta 1/4÷1.1/2"	42AS
6 chaves de luneta curvatura profunda 1/4x5/16 - 3/8x7/16 - 1/2x9/16	90AS
5/8x3/4 - 11/16x13/16 - 7/8x15/16"	
11 chaves macho hexagonal 3/64÷3/8"	96AS/B11
10 chaves de caixa bocas de 12 faces quadra de 1/2" ○ 7/16 - 1/2 - 9/16	920AS
5/8 - 11/16 - 3/4 - 13/16 - 7/8 - 15/16 - 1"	
1 extensão com quadras macho e fêmea de 1/2" 125 mm	920/21
1 extensão com quadras macho e fêmea de 1/2" 255 mm	920/22
1 cardan com quadras macho e fêmea de 1/2"	920/25
1 cabo T correção, quadra de 1/2"	920/42
1 roquete simples correção, quadra de 1/2" Ⓢ	920/50
12 chaves de caixa hexagonal 1/4" ○ □ 3/4", 7/8 - 15/16 - 1 - 1.1/16 -	928AS
1.1/8 - 1.1/4 - 1.5/16 1.1/2 - 1.5/8 - 1.11/16 - 1.7/8 - 2"	
1 extensão com quadras macho e fêmea de 3/4" 200 mm	928/21
1 cabo articulado, quadra de 3/4"	928/36A
1 cabo T correção, quadra de 3/4"	928/42
1 roquete reversível, quadra de 3/4" Ⓢ	928/55
1 alavanca com extremidades pontiaguda e em cunha	964
1 alicate de charneira fechada 250 mm	1048N
1 alicate de pressão maxilas recurvadas	1055
1 alicates de corte diagonal para serviços pesados, punhos em bi-matéria, acabamento industrial $\leq 160\text{ mm}$	1084GBM
1 tesoura de electricista	1128BMX
1 alicate combinado para trabalhos pesados, punhos bi-material, acabamento industrial = 180 mm	1150GBM
1 alicate de pontas semi-redondas com estrias, extra-longas, punhos bi-material, acabamento industrial ● 160 mm	1166GBM
4 chaves para parafusos de perfil de fenda com sextavado auxiliar ●	1260E
6,5x150 - 8x175 - 10x200 - 12x250 mm	
3 chaves para parafusos de perfil Phillips® com sextavado auxiliar ⦿	1262E
PH2x150 - PH3x175 - PH4x200 mm	
1 martelo com batente redondo e pena esférica 900 g	1377
1 martelo com batentes plásticos intermutáveis Ø 35 mm	1390
1 apalpa - folgas 150 - 200 mm	1708/20
1 rascador triangular 200 mm	1717B
5 jogo de 5 limas meia-murça, com punhos 200 mm	1719BMA...S5
1 serrote com folha de serra bi-metálica	1725



€ 

5902MT/AS 2.560,00 059021054

Sortido recomendado em combinação com RSC22 - RSC23 - RSC23C - C39T

5904VG/2M

sortido de 170 ferramentas

► Reparação automóvel

Nr. Peças/Descrição

- 16 chaves mistas, boca-luneta 6÷21 mm
- 5 chaves mistas, boca-luneta 22 - 24 - 27 - 30 - 32 mm
- 8 chaves macho sextavadas \odot 2-2,5-3-4-5-6-7-8 mm
- 5 chaves para parafusos de perfil Torx® \odot T10-T15-T20-T25-T30
- 7 pontas macho hexagonal \odot 4-5-6-7-8-10-12 mm
- 7 pontas hexagonais \odot 4-5-6-7-8-10-12 mm
- 5 pontas para parafusos de perfil XZN® \odot 5-6-8-10-12 mm
- 5 pontas com perfil XZN® \odot 5-6-8-10-12 mm
- 7 pontas para parafusos de perfil Torx® \odot T20-T25-T30-T40-T45-T50-T55
- 6 pontas para parafusos de perfil Torx® \odot T25-T30-T40-T45-T50-T55
- 7 pontas para parafusos de perfil Tamper Resistant Torx® \odot T20-T25-T30-T40-T45-T50-T55
- 1 chaves de caixa porta-pontas para artigos 867
- 1 chaves de caixa porta-pontas para artigos 867
- 5 chaves para parafusos de perfil de fenda \bullet 3x75 - 3,5x100 - 4x125 - 5,5x150 - 6,5x150 mm
- 3 chaves para parafusos de perfil Phillips® \oplus PH0x60 - PH1x80 - PH2x100 mm
- 1 chave para parafusos de perfil de fenda série curta \bullet 4x30 mm
- 1 chaves para parafusos de perfil Phillips® série curta \oplus PH1x30 mm
- 5 bits para parafusos ranhurados, coloridos \bullet 0,5x3 - 0,6x4,5 - 0,8x5,5 - 1x5,5 - 1,2x6,5 mm
- 8 bits sextavados para aparafusadoras eléctricas, coloridos \odot 2 - 2,5 - 3 - 4 - 5 - 6 - 8 - 10 mm
- 5 bits para parafusos Phillips®, coloridos \oplus PH0 - PH1 - PH2 - PH3 - PH4
- 4 bits para parafusos Phillips®, coloridos \oplus PZ1 - PZ2 - PZ3 - PZ4
- 11 bits para parafusos Torx®, coloridos \odot T6-T7-T8-T9-T10-T15-T20-T25-T27-T30-T40
- 8 bits para parafusos invioláveis Torx®, coloridos \oplus T9-T10-T15-T20-T25-T27-T30-T40
- 1 porta-pontas magnético com punho 230 mm
- 1 chave de bits reversível 100 mm
- 1 extensão para porta-bits magnético 80 mm
- 1 adaptadores para aparafusadoras \blacksquare 1/4 - \square 1/4
- 2 escopros planos 100 - 200 mm
- 1 martelo para mecânico, tipo alemão 300 g
- 1 martelo com batentes plásticos intermutáveis \varnothing 35 mm
- 1 extensões com quadras macho e fêmea - 1/2" 125 mm
- 1 extensões com quadras macho e fêmea - 1/2" 250 mm
- 1 cardan com quadras macho e fêmea de 1/2"
- 1 cabo T correção, quadra de 1/2"
- 1 roquete reversível, quadra de 1/2" \oplus
- 19 chaves de caixa sextavadas, quadra de 1/2" \odot 10÷24 - 26 - 27 - 30 - 32 mm
- 1 alicate de pontas semi-redondas extra-longas \equiv 180 mm
- 1 Alicates de pontas semi-redondas extralongas \bullet 160 mm
- 1 Alicates de corte diagonal para trabalhos pesados ∇ 160 mm
- 1 alicates de freios interiores com pontas direitas \odot 180 mm
- 1 alicates de freios interiores com pontas curvas \odot 170 mm
- 1 alicates de freios exteriores com pontas direitas \bullet 175 mm
- 1 alicates de freios exteriores com pontas curvas \bullet 175 mm

Refa. Nr.	TR
42	M05
42	M06
96T	M50
97TTX	M55
867PE	M86
867PE/L	M86
867XZN	M86
867XZN/L	M86
867TX	M86
867TX/L	M86
867RTX	M86
867/1	M86
867/2	M86
1260	M208
1262	M208
1260N	M208
1262N	M208
860LP	M85
860PE	M85
860PH	M85
860PZ	M85
860TX	M85
860RTX	M85
851SR	M85
860/55	M85
882P	M85
892/0	M85
35	M234
1370	M234
1390	M234
920AN/125	M83
920AN/250	M83
920/25	M83
920/42	M83
920/55	M83
920A	M83
1150BM	M136
1166BM	M136
1084BM	M136
1032	M145
1034	M145
1036	M145
1038	M145



M05 M06 VPM3



M50 M55 M86



M208 M85 M234



M83 M136 M145

€

5904VG/2M

1.950,00 059041198

Sortido recomendado em combinação com RSC24 - RSC24A - RSC24A-XL - C37 - C39
RSC24L - RSC24L/CAB - C59 - C39T - C39SM - C39MD - RSC23T - RSC28 - RSC50 - RSC55

5904VG/2T

jogo de 99 ferramentas

► Reparação automóvel

Nr. Peças/Descrição

- 16 chaves mistas, boca-luneta 6÷21 mm
- 5 chaves mistas, boca-luneta 22 - 24 - 27 - 30 - 32 mm
- 19 chaves de caixa sextavadas, quadra de 1/2" \odot 10÷24 - 26 - 27 - 30 - 32 mm
- 5 chaves de caixa com ponta hexagonal, quadra de 1/2" \odot 5 - 6 - 8 - 10 - 12 mm
- 1 extensão com quadras macho e fêmea de 1/2" 125 mm
- 1 extensão com quadras macho e fêmea de 1/2" 255 mm
- 1 cardan com quadras macho e fêmea de 1/2"
- 1 cabo T corrediço, quadra de 1/2"
- 1 roquete reversível, quadra de 1/2" \oplus
- 1 alicate de charneira fechada 250 mm
- 1 alicate de pressão 240 mm
- 1 Alicates de corte diagonal para trabalhos pesados \leq 160 mm
- 1 Alicates de pontas semirredondas extralongas \bullet 160 mm
- 1 alicate de pontas semi-redondas extra-longas \equiv 180 mm
- 1 alicates de freios interiores com pontas direitas \odot 180 mm
- 1 alicates de freios exteriores com pontas direitas \bullet 175 mm
- 1 alicates de freios interiores com pontas curvas \odot 170 mm
- 1 alicates de freios exteriores com pontas curvas \bullet 175 mm
- 2 escopros planos 100 - 200 mm
- 1 martelo para mecânico, tipo alemão 300 g
- 1 martelo com batentes plásticos intermutáveis \varnothing 35 mm
- 4 chaves para parafusos de perfil de fenda \bullet 3x75 - 4x100 - 5,5x150 - 6,5x150 mm
- 3 chaves para parafusos de perfil Phillips® \oplus PH0x60 - PH1x80 - PH2x100 mm
- 8 chaves de bocas 6x7 - 8x9 - 10x11 - 12x13 - 14x15 - 16x17 - 18x19 - 20x22 mm
- 9 chaves macho hexagonal \odot 1,5 - 2 - 2,5 - 3 - 4 - 5 - 6 - 8 - 10 mm
- 6 chaves macho sextavadas \odot 2 - 2,5 - 3 - 4 - 5 - 6 mm
- 6 chaves para parafusos de perfil Torx® \odot T10 - T15 - T20 - T25 - T27 - T30

Refa. Nr.	TR
42	T05
42	T06
920A	T80
920ME	T80
920/21	T80
920/22	T80
920/25	T80
920/42	T80
920/55	T80
1048N	T153
1052	T153
1084	T138
1166	T138
1150	T138
1032	T145
1036	T145
1034	T145
1038	T145
35	T234
1370	T234
1390	T234
1260	T208
1262	T208
55	T33
96/SC9	T33
96T	T52
97TTX	T55



T05 T06 T80



T153 T138 T145 T234



T208 T33 T52 T55

€

5904VG/2T 1.660,00 059041191

Sortido recomendado em combinação com RSC51 - RSC24 - RSC24A - RSC24A-XL - C37 - C39
RSC23T - C39T - RSC24L - RSC24L/CAB - C59 - RSC28 - C39SM - C39MD - RSC50 - RSC55



5904VG/3

jogo de 132 ferramentas

► Reparação automóvel

Nr. Peças/Descrição	Refa. Nr.
6 Ø 2+8 mm	31/B6N
1 punção de bico Ø 5 mm	32
1 escopros planos 200 mm	35
17 chaves mistas, boca-luneta 6÷22 mm	42
8 chaves de bocas 6x7 - 8x9 - 10x11 - 12x13 - 14x15 - 16x17 - 18x19 - 20x22 mm	55
9 chaves macho hexagonal ♂ 1,5 - 2 - 2,5 - 3 - 4 - 5 - 6 - 8 - 10 mm	96N/SC9
11 chaves macho hexagonal ♂ 2÷10 mm	96T/SP11
13 chaves macho com perfil Torx® Ⓢ T6÷T50	97TX/B13
1 Chave ajustável 300 mm	111E
13 chaves de caixa sextavadas, quadra de 1/2" Ⓞ 10÷22 mm	920A/SB13
1 extensão com quadras macho e fêmea de 1/2" 125 mm	920/21
1 extensão com quadras macho e fêmea de 1/2" 255 mm	920/22
1 cardan com quadras macho e fêmea de 1/2"	920/25
1 cabo T corrediço, quadra de 1/2"	920/42
1 roquete simples corrediço, quadra de 1/2" Ⓢ	920/50
6 chaves de caixa hexagonais com cardan e cabo em T Ⓞ 8 - 10 - 12 - 13 - 17 - 19 mm	952
1 alavanca curva com punho 450 mm	965
2 alicates de freios interiores com pontas direitas Ⓞ 180 - 225 mm	1032
2 alicates de freios interiores com pontas curvas Ⓞ 170 - 210 mm	1034
2 alicates de freios exteriores com pontas direitas ● 175 - 225 mm	1036
2 alicates de freios exteriores com pontas curvas ● 175 - 220 mm	1038
1 alicate de charmeira fechada 250 mm	1048N
1 alicate de pressão 240 mm	1057A
1 alicates de corte diagonal para serviços pesados, punhos em bi-matéria, acabamento industrial ⚡ 200 mm	1084GBM
1 alicate de corte frontal, articulado, serviço pesado, grande esforço ⚡ 200 mm	1092V
1 tesoura modelo americano 250 mm	1112
1 tesoura de electricista	1128BMX
1 alicate combinado para trabalhos pesados, punhos bi-material, acabamento industrial ⚡ 180 mm	1150GBM
4 chaves para parafusos de perfil de fenda ● 3x75 - 4x100 - 5,5x125 - 6,5x150 mm	1260
1 chave para parafusos de perfil de fenda série curta ● 6,5x30 mm	1260N
2 chaves para parafusos de perfil de fenda com sextavado auxiliar ● 8x175 - 10x200 mm	1260E
3 chaves para parafusos de perfil Phillips® Ⓢ PH0x100 - PH1x120 - PH2x100 mm	1262
1 chaves para parafusos de perfil Phillips® série curta Ⓢ PH2x30 mm	1262N
1 chaves para parafusos de perfil Phillips® com sextavado auxiliar Ⓢ PH3x175mm	1262E
1 chave para parafusos de perfil Phillips® série longa Ⓢ PH2x400 mm	1262L
1 chave para parafusos de perfil de fenda sem cabeça série longa ● 6,5x400 mm	1264L
1 martelo para mecânico, tipo alemão 500 g	1370
1 martelo com batentes plásticos intermutáveis Ø 45 mm	1390
1 chaves para filtros de óleo com cinta metálica regulável	1491
1 apalpa - folgas	1708/20
5 jogo de 5 limas meia-murça, com punhos 200 mm	1719BMA...S5
1 serrote com folha de serra bi-metálica	1726BM
1 Lata de óleo de pressão 200 cc	1751N

€

5904VG/3 2.610,00 059041062

Sortido recomendado em combinação com RSC24 - RSC24A - RSC24A-XL - C37 - C39 com 7 - 8 gavetas
RSC24L - RSC24L/CAB - C59 - RSC50 - RSC55

5904VG/3T

sortido de 102 ferramentas

► Reparação automóvel

Nr. Peças/Descrição

- 21 chaves mistas, boca-luneta 6-7-8-9-10-11-12-13-14-15-16-17
18-19-20-21-22-24-27-30-32 mm
- 8 chaves de bocas 6x7-8x9-10x11-12x13-14x15
16x17-18x19-20x22 mm
- 9 chaves macho hexagonal \odot 1,5÷10 mm
- 6 chaves macho sextavadas \odot 2-2,5-3-4-5-6 mm
- 8 chaves de caixa hexagonais com cardan e cabo em T \odot 7-8-10-12-13-14-17-19 mm
- 19 chaves de caixa sextavadas, quadra de 1/2" \odot 10-11-12-13-14-15-16-17-18-19
20-21-22-23-24-26-27-30-32 mm
- 1 extensão com quadras macho e fêmea de 1/2" 125 mm
- 1 extensão com quadras macho e fêmea de 1/2" 255 mm
- 1 cardan com quadras macho e fêmea de 1/2"
- 1 cabo T corrediço, quadra de 1/2" 305 mm
- 1 roquete reversível, quadra de 1/2" \otimes
- 1 Alicates de corte diagonal para trabalhos pesados \leq 160 mm
- 1 alicate de pontas semi-redondas extra-longas \equiv 180 mm
- 1 Alicates de pontas semi-redondas extralongas \bullet 160 mm
- 1 alicates de freios interiores com pontas direitas \odot 180 mm
- 1 alicates de freios interiores com pontas curvas \odot 170 mm
- 1 alicates de freios exteriores com pontas direitas \bullet 175 mm
- 1 alicates de freios exteriores com pontas curvas \bullet 175 mm
- 1 alicate de pressão 240 mm
- 1 alicate de charneira fechada 250 mm
- 7 chaves para parafusos de perfil de fenda \bullet 2,5x50 -3x75 - 3,5x100 - 4x125 -5,5x100 -
5,5x150 - 6,5x150 mm
- 6 chaves para parafusos de perfil Phillips® \oplus PH0x60 - PH0x100 - PH1x80
PH1x120 - PH2x100 - PH2x150 mm
- 2 escopros planos 100-200 mm
- 1 martelo para mecânico, tipo alemão 300 g
- 1 martelo com batentes plásticos intermutáveis \varnothing 35 mm
- 1 módulo

Refa. Nr.	TR
42	T05-T06
55	T33
96/SC9	T33
96T	T52
952	T63
920A	T83
920/21	T83
920/22	T83
920/25	T83
920/42	T83
920/55	T83
1084BM	T137
1150BM	T137
1166BM	T137
1032	T145
1034	T145
1036	T145
1038	T145
1052	T153
1048N	T153
1260	T199
1262	T202
35	T234
1370	T234
1390	T234
VP5	



T199 T202 T83



T145 T153 T137 T234



T52 T33 T05 T06



T63 VP5

5904VG/3T

€ 1.920,00 059041510

Sortido recomendado em combinação com C24S - C24SA - C24SA-XL - C37 - C39
C24SL - C24SL/CAB - C59 - C23ST - C39T - C28 - C39SM - C39MD - RSC50 - RSC55

5904VG/5T

jogo de 160 ferramentas

► Reparação automóvel

Nr. Peças/Descrição

- 5 chaves de caixa com ponta hexagonal, quadra de 1/2" ○ 5 - 6 - 8 - 10 - 12 mm
- 1 extensão com quadras macho e fêmea de 1/2" 125 mm
- 1 extensão com quadras macho e fêmea de 1/2" 255 mm
- 1 cardan com quadras macho e fêmea de 1/2"
- 1 cabo T correção, quadra de 1/2"
- 1 roquete reversível, quadra de 1/2" ⊗
- 19 chaves de caixa sextavadas, quadra de 1/2" ○ 10÷24 - 26 - 27 - 30 - 32 mm
- 16 chaves mistas, boca-luneta 6÷21 mm
- 5 chaves mistas, boca-luneta 22 - 24 - 27 - 30 - 32 mm
- 8 chaves de caixa hexagonais com cardan e cabo em T ○ 7 - 8 - 10 - 12 - 13 - 14 - 17 - 19 mm
- 1 módulo
- 1 alicates de freios interiores com pontas direitas ○ 180 mm
- 1 alicates de freios interiores com pontas curvas ○ 170 mm
- 1 alicates de freios exteriores com pontas direitas ● 175 mm
- 1 alicates de freios exteriores com pontas curvas ● 175 mm
- 7 chaves para parafusos de perfil Phillips® ● 2,5x50 - 3x75 - 3,5x100 - 4x125 - 5,5x100 - 5,5x150 - 6,5x150 mm
- 5 chaves para parafusos de perfil Torx® ⊕ T25 - T27 - T30 - T40 - T45
- 6 chaves macho sextavadas ○ 2 - 2,5 - 3 - 4 - 5 - 6 mm
- 8 chaves de bocas 6x7 - 8x9 - 10x11 - 12x13 - 14x15 - 16x17 - 18x19 - 20x22 mm
- 9 chaves macho hexagonal ○ 1,5 - 2 - 2,5 - 3 - 4 - 5 - 6 - 8 - 10 mm
- 3 chaves para parafusos de perfil Phillips® ● 8x150 - 8x200 - 10x200 mm
- 2 chave para parafusos de perfil de fenda série curta ● 4x30 - 6,5x30 mm
- 6 chaves para parafusos de perfil Phillips® ⊕ PH0x60 - PH0x100 - PH1x80 - PH1x120 - PH2x100 - PH2x150 mm
- 2 chaves para parafusos de perfil Phillips® ⊕ PH3x150 - PH4x200 mm
- 2 chave para parafusos de perfil Phillips® série curt ⊕ PH1x30 - PH2x30 mm
- 2 escopros planos 100 - 200 mm
- 1 martelo para mecânico, tipo alemão 300 g
- 1 martelo com batentes plásticos intermutáveis Ø 35 mm
- 1 alicate de pontas semi-redondas extra-longas = 180 mm
- 1 Alicates de pontas semi-redondas extralongas ● 160 mm
- 1 Alicates de corte diagonal para trabalhos pesados ⚡ 160 mm
- 6 pontas para aparafusadoras, para parafusos perfil Torx® ⊕ T6÷T15
- 8 pontas para aparafusadoras, para parafusos perfil Torx® ⊕ T20÷T55
- 1 chave de caixa porta-pontas com encaixe quadra fêmea
- 1 chave de caixa porta-pontas com encaixe quadra fêmea
- 6 chaves de caixa com quadra fêmea de 1/4", para parafusos com perfil Torx® ⊕ E4+E10
- 7 chaves de caixa com quadra fêmea de 1/2", para parafusos com perfil Torx® ⊕ E12+E24
- 3 chaves de caixa com ponta macho de perfil Torx® 1/2" ⊕ T55L - T60 - T70L
- 1 alicate de charneira fechada 250 mm
- 1 alicate de pressão 240 mm

Refa. Nr.	TR
920ME	T80
920/21	T80
920/22	T80
920/25	T80
920/42	T80
920/55	T80
920A	T80
42	T05
42	T06
952	T63
VP6	VP6
1032	T145
1034	T145
1036	T145
1038	T145
1290	T170
1297TX	T176
96T	T52
55	T33
96N/SC9	T33
1290	T171
1290N	T171
1292	T172
1292	T173
1292N	T173
35	T234
1370	T234
1390	T234
1150BM	T137
1166BM	T137
1084BM	T137
861TX	T112
866TX	T112
895/1	T112
895/6	T112
900FTX	T112
920FTX	T112
920TX	T112
1048N	T153
1052	T153



T80 T05 T05



T63 VP6



T145 T170 T176 T52



T33 T171 T172 T173



T234 T137 T112 T153

€

5904VG/5T

2.660,00 059041196

Sortido recomendado em combinação com RSC24 com 7 - 8 gavetas - RSC24A com 7 - 8 gavetas - RSC24A-XL - C37 com 7 - 8 gavetas - C39 com 7 - 8 gavetas RSC24L - RSC24L/CAB - C59 - RSC23T - RSC28 - C39MD - C39SM - RSC50 - RSC55



5905VG/1

jogo de 94 ferramentas para máquina de movimentação de terras (CATERPILLAR)

► Reparação automóvel

Nr. Peças/Descrição	Refs. Nr.
1 punções Ø 4 mm	30
6 Ø 2 - 3 - 4 - 5 - 6 - 8 mm	31/B6N
1 punção de bico Ø 4 mm	32
1 escopros planos 150 mm	34
1 buris 150 mm	36
17 chaves mistas, boca-luneta 6+22 mm	42
10 chaves macho hexagonal 1,5+12 mm	96/B10
1 Chaves ajustáveis com escalas, fosfatadas 300 mm	111EN
12 chave de caixa com punho, modelo longo 4+14 mm	943BX
1 alavanca curva com punho 450 mm	965
1 alicate de charneira fechada 250 mm	1048N
1 alicate de pressão 240 mm	1052
1 alicate de pressão para soldadura 280 mm	1060AL
1 alicates de corte diagonal para serviços pesados, punhos em bi-matéria, acabamento industrial 160 mm	1084GBM
1 turquês para cofragem 250 mm	1098PL
1 tesoura articulada, lâminas direitas	1122
1 tesoura de electricista	1128BMX
1 alicate combinado para trabalhos pesados, punhos bi-material, acabamento industrial 180 mm	1150GBM
1 chave para parafusos de perfil Dzus®	1201E/DZ
4 chaves para parafusos de perfil de fenda 3x75 - 4x100 - 5,5x150 - 6,5x150 mm	1260
1 chave para parafusos de perfil de fenda série curta 4x30 mm	1260N
2 chaves para parafusos de perfil de fenda com sextavado auxiliar 10x175 - 12x200 mm	1260E
3 chaves para parafusos de perfil Phillips® PH0x60 - PH1x80 - PH2x100 mm	1262
1 chaves para parafusos de perfil Phillips® série curta PH1x30 mm	1262N
1 chaves para parafusos de perfil Phillips® com sextavado auxiliar PH3x175 mm	1262E
7 chaves para parafusos de perfil Torx® T6 - T8 - T10 - T15 - T20 - T25 - T30	1267TX
1 encontrador tipo virgula 1350 g	1303
1 encontrador curvo	1305
1 encontrador tipo tacão	1306
1 encontrador tipo trilho	1310
1 encontrador redondo duplo com almofadas convexa e plana	1314
1 colher estreita simples	1326
1 colher larga simples	1327
1 colher dupla pescoço de cisne com mesas largas	1330
1 armação flexível com lima de chapreiro 9"	1338A
1 talhadeira chata com cortante direito e punho de protecção	1342PM
1 martelo com cabeça convexa redonda e pena	1345
1 martelo com cabeça redonda serrilhada e quadrada plana Ø 40 mm	1357Z/45
1 martelo para mecânico, tipo alemão 300 g	1370
1 martelo com batentes plásticos intermutáveis Ø 35 mm	1390
1 fita métrica 5 m	1692

€

5905VG/1

2.360,00 059051058

Sortido recomendado em combinação com C25



5905VG/2

jogo de 118 ferramentas

► Reparação automóvel

Nr. Peças/Descrição	Refa. Nr.
6 jogo de 2 punções, 1 punção de bico, 2 escopros planos e 1 buril em bolsa de poliéster	38/B6N
13 chaves mistas, boca-luneta 6÷14 - 17 - 19 - 22 - 24 mm	42
13 chaves de bocas 6x7 - 8x9 - 10x11 - 12x13 - 14x15 - 16x17 - 18x19 - 20x22 - 21x23 - 24x26 - 25x28 - 27x29 - 30x32 mm	55
3 chaves curvas de lunetas 11x13 - 14x17 - 19x22 mm	83
10 chaves macho hexagonal \odot 1,5÷12 mm	96N/B10
6 chaves para parafusos de perfil Torx®	97TTX
\odot T10 - T15 - T20 - T25 - T30 - T40	
2 chaves de impacto hexagonal, quadra de 1/2" \odot 17 - 19 mm	720
20 chaves de caixa sextavadas, quadra de 1/2"	920A
\odot 10÷24 - 26 - 27 - 28 - 30 - 32 mm	
1 extensão com quadras macho e fêmea de 1/2" 125 mm	920/21
1 extensão com quadras macho e fêmea de 1/2" 255 mm	920/22
1 cardan com quadras macho e fêmea de 1/2"	920/25
1 cabo T correção, quadra de 1/2"	920/42
1 roquete reversível, quadra de 1/2" \odot	920/55
8 chaves de caixa hexagonais com cardan e cabo em T \odot 7 - 8 - 10 - 11 - 13 - 14 - 17 - 19 mm	952
1 chaves em T para velas com cardan. série normal	959
1 chave em cruz para porcas de rodas \odot 17x19x22x \blacksquare 1/2"	979
1 alicates de freios interiores com pontas direitas \odot 180 mm	1032
1 alicates de freios interiores com pontas curvas \odot 170 mm	1034
1 alicates de freios exteriores com pontas direitas \bullet 175 mm	1036
1 alicates de freios exteriores com pontas curvas \bullet 175 mm	1038
1 alicate de charneira fechada 250 mm	1048N
1 alicate de pressão 240 mm	1052
1 alicates de corte diagonal para serviços pesados, punhos em bi-matéria, acabamento industrial ∇ 160 mm	1084GBM
1 tesoura articulada, lâminas direitas 250 mm	1122
1 tesoura de electricista	1128BMX
1 alicate combinado para trabalhos pesados, punhos bi-material, acabamento industrial \equiv 180 mm	1150GBM
1 alicate de pontas semi-redondas com estrias, extra-longas, punhos bi-material, acabamento industrial \bullet 160 mm	1166GBM
8 chaves para parafusos de perfil de fenda	1260
\bullet 2,5x50 - 3x75 - 3,5x100 - 4x125	
5,5x125 - 6,5x150 - 8x200 - 10x200 mm	
2 chaves para parafusos de perfil de fenda com sextavado auxiliar \bullet	1260E
10x200 - 12x250 mm	
1 chave para parafusos de perfil de fenda série curta \bullet 6,5x30 mm	1260N
4 chaves para parafusos de perfil Phillips® \oplus PH0x60 - PH1x80 - PH2x100 - PH3x150 mm	1262
1 martelo para mecânico, tipo alemão 400 g	1370
1 martelo com batentes plásticos intermutáveis \varnothing 35 mm	1390
1 chaves para filtros de óleo com cinta metálica regulável	1491
1 verificador de tensão 3÷48 V	1498

€

5905VG/2 2.210,00 059051044

Sortido recomendado em combinação com C25

5908VG/2T

sortido de 214 ferramentas

► Reparação automóvel

Nr. Peças/Descrição

Refa. Nr.	TR
42	T05
42	T06
31	T31
32	T31
55	T31
96N/SC9	T31
920ME	T80
920/21	T80
920/22	T80
920/25	T80
920/42	T80
920/55	T80
920A	T80
1032	T145
1034	T145
1036	T145
1038	T145
1032	T146
1032	T146
1036	T146
1036	T146
1260	T167
1260N	T167
1262	T168
1262N	T168
952	T63
1262L	T209
1264L	T209
97TTX	T55
720	T111
720/21	T111
720LC	T111
920PE	T113
920TX	T113
920XZN	T113
1719BMA8/S5	T236
1491	T264
1494	T264
1494E	T264
1494Q	T264
1494T	T264
1494XZN	T264
1496/C	T264
35	T234
1370	T234
1390	T234
1048N	T153
1052	T153
1150	T138
1166	T138
1084	T138
928A	T105
928/21	T106
928/22	T106
928/42	T106
928/55	T106
VP6	VP6
96N	
111E	
965	
1112	
1128BMX	
1370	
1708/20	
1712	
1715	
1717B	
1726	
1737NX	
1751N	
1771	

- 16 chaves mistas, boca-luneta 6+21 mm
- 5 chaves mistas, boca-luneta 22 - 24 - 27 - 30 - 32 mm
- 5 saca-troços Ø 2 - 3 - 4 - 5 - 6 mm
- 1 punção de bico Ø 4 mm
- 12 chaves de bocas 6x7 - 8x9 - 10x11 - 12x13 - 14x15 - 16x17 - 18x19 - 20x22 - 21x23 - 24x26 - 27x29 - 30x32 mm
- 9 chaves macho hexagonal ○ 1,5 - 2 - 2,5 - 3 - 4 - 5 - 6 - 8 - 10 mm
- 5 chaves de caixa com ponta hexagonal, quadra de 1/2" ○ 5 - 6 - 8 - 10 - 12 mm
- 1 extensão com quadras macho e fêmea de 1/2" 125 mm
- 1 extensão com quadras macho e fêmea de 1/2" 255 mm
- 1 cardan com quadras macho e fêmea de 1/2"
- 1 cabo T corrediço, quadra de 1/2"
- 1 roquete reversível, quadra de 1/2" ⊕
- 19 chaves de caixa sextavadas, quadra de 1/2" ○ 10+24 - 26 - 27 - 30 - 32 mm
- 1 alicates de freios interiores com pontas direitas ○ 180 mm
- 1 alicates de freios interiores com pontas curvas ○ 170 mm
- 1 alicates de freios exteriores com pontas direitas ● 175 mm
- 1 alicates de freios exteriores com pontas curvas ● 175 mm
- 1 alicates de freios interiores com pontas direitas ○ 140 mm
- 1 alicates de freios interiores com pontas direitas ○ 225 mm
- 1 alicates de freios exteriores com pontas direitas ● 140 mm
- 1 alicates de freios exteriores com pontas direitas ● 225 mm
- 9 chaves para parafusos de perfil de fenda ● 3x75 - 3x100 - 4x100 - 4x150 - 5,5x100 - 5,5x150 - 6,5x150 - 8x150 - 10x200 mm
- 2 chave para parafusos de perfil de fenda série curta ● 4x30 - 6,5x30 mm
- 7 chaves para parafusos de perfil Phillips* ⊕ PH0x60 - PH0x100 - PH1x80 - PH1x120 - PH2x100 - PH2x150 - PH3x150 mm
- 2 chaves para parafusos de perfil Phillips* série curta ⊕ PH1x30 - PH2x30 mm
- 8 chaves de caixa hexagonais com cardan e cabo em T ○ 7 - 8 - 10 - 12 - 13 - 14 - 17 - 19 mm
- 2 chave para parafusos de perfil Phillips* série longa ⊕ PH1x400 - PH2x400 mm
- 3 chave para parafusos de perfil de fenda sem cabeça série longa ● 3x300 - 4x400 - 5x400 mm
- 6 chaves para parafusos de perfil Torx* ⊕ T10-T15-T20-T25-T27-T30
- 12 chaves de impacto hexagonal, quadra de 1/2" ○ 10-13-17-18-19-21-22-24-27-30-32 mm
- 1 extensão com quadras macho e fêmea de 1/2" 125 mm
- 3 ○ 17-19-21
- 5 chave de caixa com ponta macho sextavada ○ 5L - 6L - 7L - 8L - 10L
- 4 chaves de caixa com ponta macho de perfil Torx* 1/2" ⊕ T40L - T45L - T55L - T70L
- 3 chaves de caixa com ponta macho de perfil XZN* ○ M6L - M8L - M12L
- 5 limas perfis diversos 200 mm
- 1 chaves para filtros de óleo com cinta metálica regulável 110 mm
- 1 chave quadra para bujões de óleo ■ 10 mm
- 7 chave sextavada para bujões de óleo ○ 8-9-10-11-12-14-17 mm
- 4 chave macho quadra para bujões de óleo ○ 8-9,5-12-13 mm
- 1 chave macho triangular para bujões de óleo Δ
- 1 chave macho perfil XZN* para bujões de óleo ○
- 1 chave para bujões de óleo
- 2 escopros planos 100 - 200 mm
- 1 martelo para mecânico, tipo alemão 300 g
- 1 martelo com batentes plásticos intermutáveis Ø 35 mm
- 1 alicate de charneira fechada 250 mm
- 1 alicate de pressão 240 mm
- 1 alicate de pontas semi-redondas extra-longas = 180 mm
- 1 Alicates de pontas semirredondas extralongas ● 160 mm
- 1 Alicates de corte diagonal para trabalhos pesados † 160 mm
- 11 chaves de caixa, quadra de 3/4" ○ 22-24-27-30-32-34-36-38-41-46-50 mm
- 1 extensão com quadras macho e fêmea de 3/4" 200 mm
- 1 extensão com quadras macho e fêmea de 3/4" 380 mm
- 1 cabo T corrediço, quadra de 3/4" 450 mm
- 1 roquete reversível, quadra de 3/4" ⊕
- 1 módulo
- 4 chaves macho hexagonal ○ 13-14-17-19 mm
- 1 Chave ajustável 300 mm
- 1 alavanca curva com punho
- 1 tesoura modelo americano 250 mm
- 1 tesoura de electricista
- 1 martelo para mecânico, tipo alemão 1000 g
- 1 apalpa - folgas
- 1 pesca peças
- 1 espelho telescópico
- 1 rascador triangular 200 mm
- 1 serrote com folha de serra bi-metálica 440 mm
- 1 Escova de fios de aço
- 1 Lata de óleo de pressão 200 cl
- 1 x - acto com lâmina divisível de 18 mm



T65 T06 T31



T80 T145 T146



T167 T168 +96N +1771



T63 T209



T55 T111 T113 T236



T264 T234 T153 T138



T105 T106 VP6



5908VG/2T € 4.500,00 059081017

Sortido recomendado em combinação com RSC28

5935VG/1MB

jogo de 98 ferramentas para caixa de ferramentas C35, em tabuleiros maleáveis



MB12



MB39



MB46

► Reparação automóvel

Nr. Peças/Descrição

- 21 chaves mistas, boca-luneta 6-7-8-9-10-11-12-13-14-15-16-17-18-19-20-21-22-24-27-30-32 mm
- 8 chaves de bocas 6x7-8x9-10x11-12x13-14x15
16x17-18x19-20x22 mm
- 1 alicate de charneira fechada 250 mm
- 4 chaves para parafusos de perfil de fenda 3x75-4x100-5x125-6,5x150 mm
- 3 chaves para parafusos de perfil Phillips® PH0x60-PH1x80-PH2x100 mm
- 6 chaves para parafusos de perfil Torx® T8-T10-T15-T20-T25-T30
- 9 chaves macho sextavadas com uma extremidade esférica cromada
- 6 chaves macho sextavadas 2-2,5-3-4-5-6
- 1 alicate de pressão 240 mm
- 19 chaves de caixa sextavadas, quadra de 1/2" 10-11-12-13-14-15-16-17-18-19-20-21-22-23-24-26-27-30-32 mm
- 1 extensão com quadras macho e fêmea de 1/2" 125 mm
- 1 extensão com quadras macho e fêmea de 1/2" 250 mm
- 1 cardan com quadras macho e fêmea de 1/2"
- 1 cabo T correção, quadra de 1/2"
- 1 roquete reversível, quadra de 1/2"
- 5 chave de caixa com ponta macho sextavada 5-6-8-10-12 mm
- 1 alicates de freios interiores com pontas direitas 180 mm
- 1 alicates de freios interiores com pontas curvas 170 mm
- 1 alicates de freios exteriores com pontas direitas 175 mm
- 1 alicates de freios exteriores com pontas curvas 175 mm
- 1 escopros planos 200 mm
- 1 Alicates de corte diagonal para trabalhos pesados 160 mm
- 1 alicate de pontas semi-redondas extra-longas 180 mm
- 1 Alicates de pontas semi-redondas extralongas 160 mm
- 1 martelo para mecânico, tipo alemão 500 g
- 1 martelo com batentes plásticos intermutáveis 35 mm

Refa. Nr.	TR
42	MB12
55	MB12
1048N	MB12
1260	MB46
1262	MB46
1267TX	MB46
96BPC/SC9	MB46
96T	MB46
1052	MB46
920A	MB39
920/21	MB39
920/22	MB39
920/25	MB39
920/42	MB39
920/55	MB39
920PE	MB39
1032	MB39
1034	MB39
1036	MB39
1038	MB39
35	MB39
1084BM	MB39
1150BM	MB39
1166BM	MB39
1370	MB39
1390	MB39

€

5935VG/1MB 1.880,00 059351321

Sortido recomendado em combinação com C35

5940SBK

Sortido de 125 ferramentas

► Reparação de motociclos

Nr. Peças/Descrição

- 1 punções Ø 2 mm
- 1 punção de bico Ø 4 mm
- 1 escopros planos 125 mm
- 10 chaves mistas, boca-luneta 6 - 7 - 8 - 10 - 11 - 12 - 13 - 14 - 17 - 19 mm
- 6 chaves de bocas 6x7 - 8x9 - 10x11 - 12x13 - 14x15 - 16x17 mm
- 9 chaves macho hexagonal 1,5 - 2 - 2,5 - 3 - 4 - 5 - 6 - 8 - 10 mm
- 1 Chaves dinâmicas ZERO-RESET 3/8", 10+50 Nm
- 54 jogo com 52 pontas hexagonais, 10 mm, e 2 acessórios
- 17 jogo com 12 chaves de caixa e 5 acessórios
- 1 adaptador, chaves quadra 1/2" fêmea e 3/8" macho
- 2 chaves de caixa para velas 14 - 16 mm
- 1 alicate de pontas extra - longas 283 mm
- 2 alicates de freios interiores com pontas direitas 140 - 180 mm
- 1 alicates de freios exteriores com pontas direitas 140x1,3 mm
- 1 alicate de corte diagonal, punhos com duplo revestimento PVC, acabamento industrial 160 mm
- 1 tesoura de electricista
- 1 alicate combinado para trabalhos pesados, punhos com duplo revestimento PVC, acabamento industrial 180 mm
- 1 chave para parafusos de perfil Dzús®
- 4 chaves para parafusos de perfil de fenda 3x75 - 4x100 - 5,5x100 - 6,5x150 mm
- 3 chave para parafusos de perfil Phillips® PH0x60 - PH1x80 - PH2x100 mm
- 1 busca - pólos
- 1 martelo para mecânico, tipo alemão 300 g
- 1 chaves para filtros de óleo com cinta metálica regulável
- 1 apalpa - folgas
- 1 mini serrote
- 1 Escova de fios de latão
- 1 almotolia plástica 250 cc

Refa. Nr.
30
32
34
42
55
96/SC9
666/5
867/C52
920A/C12X
910/16
956C
1009/LA
1032
1036
1082G
1128BM
1150G
1201E/DZ
1201E
1202E
1254
1370
1491
1708/13
1725CR
1737
1754

€

5940SBK 1.420,00 059401082

Sortido recomendado para usar com os itens C41S - C41H - C42S - C42H - C42S - C41S

5941VU/M

Sortido de 64 ferramentas para carrinho C41, em tabuleiro maleável

► Utilização universal

Nr. Peças/Descrição

- 16 chaves mistas, boca-luneta 6-7-8-9-10-11-12-13-14-15-16-17-18-19-21-22 mm
- 9 chaves macho hexagonal ○
- 1 fita métrica 5 m
- 19 chaves de caixa sextavadas, quadra de 1/2" ○ 10-11-12-13-14-15-16-17-18-19-20-21-22-23-24-26-27-30-32 mm
- 1 cardan com quadras macho e fêmea de 1/2"
- 1 cabo T corrediço, quadra de 1/2"
- 1 roquete reversível, quadra de 1/2" ⊕
- 2 extensões com quadras macho e fêmea - 1/2" 125-250 mm
- 1 Chave ajustável 250 mm
- 1 alicate de charneira fechada 250 mm
- 1 alicate de corte diagonal, punhos bi-material, acabamento industrial ⚡ 160 mm
- 1 tesoura de electricista 145 mm
- 1 alicate combinado para trabalhos pesados, punhos bi-material, acabamento industrial = 180 mm
- 1 alicate de pontas semi-redondas com estrias, extra-longas, punhos bi-material, acabamento industrial ● 160 mm
- 3 chaves para parafusos de perfil de fenda ● 3,5x100-5,5x125-6,5x150 mm
- 3 chaves para parafusos de perfil Phillips® ⊕ PH0-PH1-PH2
- 1 martelo para mecânico, tipo alemão 300 g
- 1 x - acto com lâmina divisível de 18 mm 18 mm

Refa. Nr.	TR
42	MC12
96/SC9	MC12
1692/5	MC12
920A	MC21
920/25	MC21
920/42	MC21
920/55	MC21
920AN	MC21
111E	
1048N	
1082GBM	
1128BMX	
1150GBM	
1166GBM	
1260	
1262	
1370	
1771	



MC21



MC12



5941VU/M

€ 945,00 059411002

Sortido recomendado para usar com os itens C41

► Utilização universal

Nr. Peças/Descrição

- 21 chaves mistas 6-7-8-9-10-11-12-13-14-15-16-17-18-19-20-21-22-24-27-30-32 mm
 9 chaves macho sextavadas com uma extremidade esférica cromadas \odot 1,5-2-2,5-3-4-5-6-8-10 mm
 1 chave de caixa porta-pontas com encaixe quadra fêmea \square 1/4 - \square 1/4
 1 chave de caixa porta-pontas com encaixe quadra fêmea \square 1/4 - \square 3/8
 1 chave de caixa porta-pontas com encaixe quadra fêmea \square 5/16 - \square 1/2
 13 chaves de caixa sextavadas, quadra de 1/4" \odot 4-4,5-5-5,5-6-7-8-9-10-11-12-13-14 mm
 9 chaves de caixa série longa, boca sextavadas \odot 5-6-7-8-9-10-11-12-13 mm
 5 chaves de caixa com ponta sextavadas, quadra de 1/4" \odot 3-4-5-6-7 mm
 4 chaves de caixa com ponta de perfil de fenda \bullet 0,8x4-1x5,5x1,2x6,5-1,2x8 mm
 4 chaves de caixa com ponta de perfil Phillips® \oplus PH1-PH2-PH3-PH4
 7 chaves de caixa com ponta macho de perfil Torx® \otimes T10-T15-T20-T25-T27-T30-T40
 1 adaptador quadra fêmea de 1/4" para quadra macho de 3/8" \square 1/4 - \blacksquare 3/8
 1 extensão, quadra 1/4" 50 mm
 1 extensão, quadra 1/4" 100 mm
 1 extensão, quadra 1/4" 150 mm
 1 cardan com quadras macho e fêmea de 1/4"
 1 extensão com punho, quadra macho de 1/4" 176 mm
 1 cabo T corrediço, quadra de 1/4" 115 mm
 1 roquete reversível, quadra de 1/4" \otimes 125 mm
 17 chaves de caixa, boca sextavadas 3/8" \odot 6-7-8-9-10-11-12-13-14-15-16-17-18-19-20-21-22 mm
 1 redução quadra fêmea de 3/8" para quadra macho de 1/4" \square 3/8 - \blacksquare 1/4
 1 adaptador, chaves quadra 1/2" fêmea e 3/8" macho \square 3/8 - \blacksquare 1/2
 1 extensões com quadras macho e fêmea - 3/8" 125 mm
 1 extensões com quadras macho e fêmea - 3/8" 250
 1 cardan com quadras macho e fêmea de 3/8"
 1 cabo T corrediço, quadra de 3/8" 210 mm
 1 roquete reversível, quadra de 3/8" 72 dentes \otimes 200 mm
 21 chaves de caixa sextavadas, quadra de 1/2" \odot 8-10-11-12-13-14-15-16-17-18-19-20-21-22-23-24-26-27-28-30-32 mm
 1 redução quadra fêmea de 1/2" para quadra macho de 3/8" \square 1/2 - \blacksquare 3/8
 1 cardan com quadras macho e fêmea de 1/2"
 1 extensões com quadras macho e fêmea - 1/2" 125 mm
 1 extensões com quadras macho e fêmea - 1/2" 250 mm
 1 cabo T corrediço, quadra de 1/2" 305 mm
 1 roquete reversível, quadra de 1/2" \otimes 275 mm
 3 chaves de caixa 3/8" para velas \odot 16 mm (5/8")-17,8 (11/16")-20,8 (13/16")
 6 chaves para parafusos de perfil de fenda \bullet 0,4x2,5x50-0,5x3x75-0,8x4x100-1,0x5,5x125
 1,2x6,5x150-1,2x8x200 mm
 1 chave para parafusos de perfil de fenda, série extra curta \bullet 0,8x4x30 mm
 4 chaves para parafusos de perfil Phillips® \oplus PH0x60-PH1x80PH2x100PH3x150 mm
 1 chave para parafusos de perfil Phillips®, série extra curta \oplus PH1x30 mm
 12 chaves para parafusos de perfil Torx®, com punho \otimes T06-T07-T08-T09-T10-T15-T20-T25-T27-T30-T40-T45
 1 busca - pólos \bullet 0,5x3,5x100 mm
 1 alicates de freios interiores com pontas direitas \odot 180 mm
 1 alicates de freios interiores com pontas curvas \odot 170 mm
 1 alicates de freios exteriores com pontas direitas \bullet 175 mm
 1 alicates de freios exteriores com pontas curvas \bullet 175 mm
 1 alicate de charneira fechada 250 mm
 1 alicate de pressão 240 mm
 1 alicate de pressão 240 mm
 1 Alicates de corte diagonal \ddagger 160 mm
 1 turquês para cofragens 220 mm
 1 tesoura de electricista
 1 alicate de pontas semi-redondas extra-longas \equiv 180 mm
 1 Alicates de pontas semi-redondas extralongas \bullet 160 mm
 3 punções \varnothing 2-3-4 mm
 6 saca-troços \varnothing 2-3-4-5-6-8 mm
 1 punção de bico \varnothing 4 mm
 1 escopros planos 150 mm
 2 escopros planos 200-250 mm
 1 buris 125 mm
 1 martelo para mecânico, tipo alemão 500 g
 1 martelo com batentes plásticos intermutáveis \varnothing 35 mm
 1 fita métrica 3 m
 1 lman telescópico com cabeça flexível
 1 limas quadradas meia-murças, com punho 200 mm
 1 limas triangulares meia-murças, com punho 200 mm
 1 limas chatas meia-murças, com punho 200 mm
 1 limas meia-cana meia-murças, com punho 200 mm
 1 limas redondas meia-murças, com punho 200 mm
 1 Escova de fios de aço
 1 x - acto com lâmina divisível de 18 mm

Refa. Nr.	TR
42	MM11
96BPC/SC9	MM11
895/1	MM105
895/3	MM105
895/6	MM105
900	MM105
900L	MM105
900ME	MM105
900LP	MM105
900PH	MM105
900TX	MM105
900/16	MM105
900/20	MM105
900/20L	MM105
900/21	MM105
900/25	MM105
900BG/30	MM105
900/42	MM105
900/55	MM105
910A	MM105
910/15	MM105
910/16	MM105
910/21	MM105
910/22	MM105
910/25	MM105
910/42	MM105
910/55	MM105
920A	MM105
920/15	MM105
920/25	MM105
920AN	MM105
920AN	MM105
920/42	MM105
920/55	MM105
956E	MM105
1201E	MM210
1201EN	MM210
1202E	MM210
1202EN	MM210
1207E/TX	MM210
1253	MM210
1032	MM129
1034	MM129
1036	MM129
1038	MM129
1048N	MM129
1052	MM129
1052	MM129
1082BM	MM129
1098	MM129
1128BM	MM129
1150BM	MM129
1166BM	MM129
30	MM230
31	MM230
32	MM230
34	MM230
35	MM230
36	MM230
1370	MM230
1390	MM230
1692	MM230
1712TF	MM230
1719BMA..Q	MM230
1719BMA..T	MM230
1719BMA..P	MM230
1719BMA..M	MM230
1719BMA..R	MM230
1737NX	MM230
1771	MM230



5945VUM

3.060,00 059451011

Ideal em combinação com o item C45



5954VG

jogo de 138 ferramentas

► Reparação automóvel

Nr. Peças/Descrição	Refa. Nr.
5 saca-troços Ø 2-3-4-5-6 mm	31
1 punção de bico Ø 4 mm	32
1 escopros planos 125 mm	34
18 chaves mistas, boca-luneta 6÷22 - 24 mm	42
8 chaves de bocas 6x7 - 8x9 - 10x11 - 12x13 - 14x15 - 16x17 - 18x19 - 20x22 mm	55
3 chaves de luneta curvatura profunda 12x13 - 14x15 - 17x19 mm	90
13 chaves macho hexagonal Ø 2÷10 - 12 mm	96
4 chaves de impacto hexagonal, quadra de 1/2" Ø 17 - 19 - 21 - 22 mm	720
20 chaves de caixa sextavadas, quadra de 1/2" Ø 10-11-12-13-14-15-16-17-18-19-20-21-22-23-24-26-27-28-30-32 mm	920A
1 extensão com quadras macho e fêmea de 1/2"	920/21
1 extensão com quadras macho e fêmea de 1/2"	920/22
1 cardan com quadras macho e fêmea de 1/2"	920/25
1 cabo T correção, quadra de 1/2"	920/42
1 roquete reversível, quadra de 1/2" Ⓞ	920/55
3 chaves de caixa com punho, modelo longo Ø 8 - 10 - 13 mm	943BX
10 chaves de caixa hexagonais com cardan e cabo em T Ø 6 - 7 - 8 - 10 - 11 - 12 - 13 - 14 - 17 - 19 mm	952
3 chaves de caixa para velas Ø 16 - 17,8 - 20,8 mm	956C
1 alavanca com extremidades pontiaguda e em cunha	964
1 alicates de freios interiores com pontas direitas Ⓞ	1032
1 alicates de freios interiores com pontas curvas Ⓞ	1034
1 alicates de freios exteriores com pontas direitas ●	1036
1 alicates de freios exteriores com pontas curvas ●	1038
1 alicate de charmeira fechada 250 mm	1048N
1 alicate de pressão 240 mm	1052
1 alicates de pressão bicos longos 175 mm	1058
1 Alicates de corte diagonal ⚡ 160 mm	1082BM
1 tesoura de electricista	1128BMX
1 alicate de pontas semi-redondas extra-longas = 180 mm	1150BM
1 Alicates de pontas semi-redondas extralongas ● 160 mm	1166BM
1 busca - pólos ● 6÷24V	1254
1 chaves para parafusos de perfil de fenda ● 8 x 200 mm	1260
1 chave para parafusos de perfil de fenda série curta ● 6,5x30 mm	1260N
1 chaves para parafusos de perfil Phillips® Ⓞ 8 x 150 mm	1262
1 chaves para parafusos de perfil Phillips® série curta Ⓞ PH2x30 mm	1262N
5 chaves para parafusos de perfil Torx® Ⓞ T8 - T10 - T15 - T20 - T25	1267TX
8 chaves para parafusos	1263/D8
1 martelo para mecânico, tipo alemão 300 g	1370
1 martelo anti - recuo com batentes plásticos intermutáveis Ø 35 mm	1392
1 alicate para as molas dos travões de tambor 210 mm	1470
1 alicate para cravar terminais não isolados	1603
1 fita métrica 5 m	1692
1 apalpa - folgas	1708/20
1 pesca-peças magnético 1,8 kg	1712E/2
6 jogo de 3 limas 160 mm	1720/B6
1 almotolia plástica 150 cc	1754

€

5954VG 2.610,00 059541054

Sortido recomendado em combinação com C54VG

5957VG

Sortido de 174 ferramentas

► Reparação de motocicletas



Nr. Peças/Descrição	Refa. Nr.
6 saca-troços Ø 2 - 3 - 4 - 5 - 6 - 8 mm	31/SP6
2 punções, 1 punção de bico e 3 escopros	38/SP6
17 chaves mistas, boca-luneta 6-7-8-10-11-12-13-14-15-16-17-19-21-22-24-27-30 mm	42
12 chaves de bocas 6x7 ÷ 30x32 mm	55/S12X
8 chaves macho hexagonal 2 ÷ 10 mm	96T/S8
1 chaves macho hexagonal Ø 2,5 ÷ 12 mm	96N/G7
8 T9 ÷ T40	97TX/SC8
5 chaves macho hexagonal com perfil XZN® Ø M5 ÷ M12	98XZN/B5
1 Chave ajustável 250 mm	111E
1 Chaves dinâmicas ZERO-RESET 1/2", 40÷200 Nm	666/20
13 chaves de caixa sextavadas, quadra de 1/2" Ø 10÷22 mm	920A/SB13
8 chaves de caixa sextavadas, quadra de 1/2" Ø 23÷32 mm	920A/SB8
4 chaves de caixa com ponta de fenda 1,2x6,5 - 1,2x8 - 1,6x9 - 2x12 mm	920LP
3 chaves de caixa com ponta de perfil Phillips® PH2 - 3 - 4	920PH
1 extensão com quadras macho e fêmea de 1/2" 125 mm	920/21
1 extensão com quadras macho e fêmea de 1/2" 255 mm	920/22
1 cardan com quadras macho e fêmea de 1/2"	920/25
1 cabo T correção, quadra de 1/2"	920/42
1 roquete reversível, quadra de 1/2"	920/55
2 chaves de impacto hexagonal, quadra de 1/2" Ø 17 - 19 mm	720
10 chaves de caixa hexagonais com cardan e cabo em T Ø 7 - 8 - 10 - 11 - 12 - 13 - 14 - 15 - 17 - 19 mm	952
3 chaves em T para velas com cardan. série normal 14 - 16 - 20,8 mm	959
1 alavanca com extremidades chata e pontiaguda	963
1 chave em cruz para porcas de rodas 1/2" - 17 - 19 - 22 mm	979
2 alicates de freios interiores com pontas direitas Ø 140 - 180 mm	1032
2 alicates de freios interiores com pontas curvas Ø 130 - 170 mm	1034
2 alicates de freios exteriores com pontas direitas 140x1,3 - 175 mm	1036
2 alicates de freios exteriores com pontas curvas 135x1,3 - 175 mm	1038
1 alicate de charneira fechada 250 mm	1048N
1 alicate de pressão 240 mm	1052
1 Alicates de corte diagonal 160 mm	1082BM
1 Alicates de corte diagonal para trabalhos pesados 160 mm	1084BM
1 alicate de corte frontal, articulado, serviço pesado, grande esforço 180 mm	1092V
1 tesoura modelo americano 250 mm	1112
1 tesoura de electricista	1128BMX
1 alicate de pontas semi-redondas extra-longas 180 mm	1150BM
1 Alicates de pontas semi-redondas extralongas 160 mm	1166BM
1 Alicates de pontas curvas semirredondas extralongas 200 mm	1168BM
2 chaves para parafusos de perfil de fenda 8x200 - 10x200 mm	1260
1 chaves para parafusos de perfil Phillips® PH3x150 mm	1262
8 chaves para parafusos	1263/D8
2 martelo para mecânico, tipo alemão 300 - 600 g	1370
1 martelo com batentes plásticos intermutáveis Ø 35 mm	1390
11 saca pernos com roletes M5÷M16 mm	1433/C11
1 chaves para filtros de óleo com cinta metálica regulável	1491
1 verificador de tensão	1498
1 fita métrica 5 m	1692
1 apalpa - folgas	1708/20
1 pesca-peças magnético 1,8 kg	1712E/2
1 rascador curvo 200 mm	1717A
1 rascador triangular 200 mm	1717B
5 limas perfis diversos 200 mm	1719BMA8/S5
1 serrote com folha de serra bi-metálica	1725
1 almotolia metálica 200 cc	1751
1 x - acto com lâmina divisível de 18 mm	1771
1 paquímetro	1650

€

5957VG 4.550,00 059571007

Sortido recomendado para usar com os itens C57S A - C57S B - C57SP- RSC50 PS - C55PS - C55PSE

MÓDULOS TIPO SOFT PARA FERRAMENTAS



RSC23T
RSC24
RSC24A
RSC24AXL
RSC24L/7
RSC24L-CAB
RSC28
C30M
C37
C37A
C39
C39T
C39MD
C39SM
RSC51
C57S
C59
RSC55

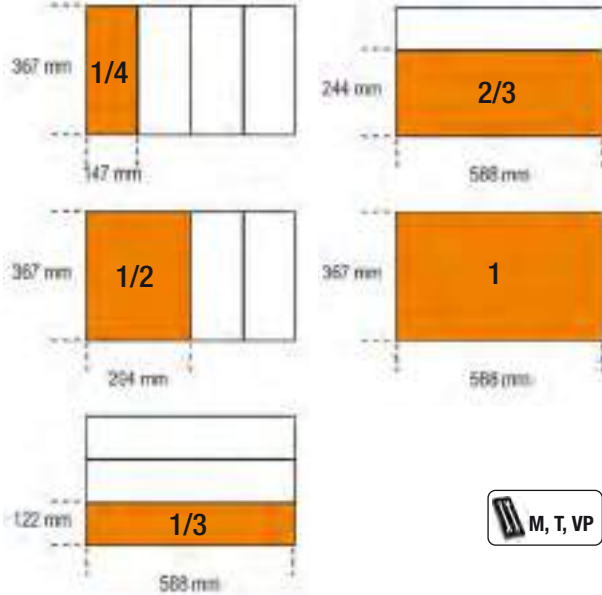

533÷543
549÷558

M13

11



42SLIM 8-10-11-12
13-14-15-16-17
18-19 mm

1,2 kg

M13	€ 175,00	1 024500013
MV13	€ 39,50	1 024510013

M25

40



42 6-7-8-9-10-11-12-13-14-15-16-17-18-19-21-22-24-27 mm
90 6x7-8x9-10x11-12x13-14x15-16x17-18x19 mm
123Q1/4
123Q3/8
123Q1/2
142 8-9-10-11-12-13-14-15-16-17-18-19 mm

5,1 kg

M25	€ 775,00	1 024500025
MV25	€ 75,50	1 024510873

M01

22



42 6-7-8-9-10-11-12-13-14-15-16-17-18-19-20-21-22-24-27-30-32-36 mm

4,5 kg

M01	€ 475,00	1 024500001
MV10	€ 75,50	1 024510010

M02

26



42 6-7-8-9-10-11-12-13-14-15-16-17-18-19-20-21-22-23-24-25-26-27-28-29-30-32 mm

6,3 kg

M02	€ 540,00	1 024500002
MV02	€ 75,50	1 024510002

M05

16



42 6-7-8-9-10-11-12-13-14-15-16-17-18-19-20-21 mm

1,5 kg

M05	€ 235,00	1 024500005
MV15	€ 39,50	1 024510015

M06

5



42 22-24-27-30-32 mm

2,1 kg

M06	€ 166,00	1 024500006
MV16	€ 53,50	1 024510016

M30

31



55 6x7-8x9-10x11-12x13-14x15-16x17-18x19-20x22-21x23-24x27-30x32 mm
90 6x7-8x9-10x11-12x13-14x15-16x17-18x19-20x22-21x23-24x27-30x32 mm
96BPC/SC9 1,5-2-2,5-3-4-5-6-8-10 mm

4,2 kg

M30	€ 453,00	1 024500030
MV30	€ 75,50	1 024510030



M31

27

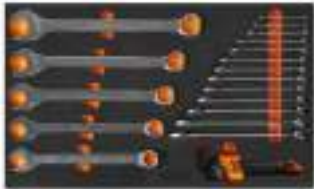

42AS 1/4 - 9/32 - 5/16 - 3/8 - 7/16 - 1/2 - 9/16
- 19/32 - 5/8 - 11/16 - 3/4 - 13/16 - 7/8 -
15/16 - 1 - 1.1/16 - 1.1/8 - 1.1/4
96BP/AS-SC9 1/16 - 3/32 - 1/8 - 5/32 - 3/16 - 7/32 - 1/4
- 5/16 - 3/8

4,5 kg

M31	473,00	1	024500031
MV31	75,50	1	024510031

M33

17



55 6x7-8x9-10x11
12x13-14x15
16x17-18x19
20x22 mm
96/SC9 1,5+10 mm

1,1 kg

M33	110,00	1	024500033
MV33	39,50	1	024510033

M38

4



55 21x23-24x26
27x29-30x32 mm

1,7 kg

M38	92,50	1	024500038
MV38	53,50	1	024510038

M39

36



31 2-3-4-5-6-8 mm
32 4 mm
55 6x7 - 8x9 - 10x11 - 12x13 - 14x15 - 16x17
- 18x19 - 20x22 - 21x23 - 24x26 - 25x28
- 27x29 - 30x32 mm
96/SC12 2 - 2,5 - 3 - 3,5 - 4 - 4,5 - 5 - 6 - 7 - 8 - 9
- 10 mm
96 12-14-17-19 mm

5,7 kg

M39	372,00	1	024500039
MV39	75,50	1	024510039

M40

7



90 6x7-8x9-10x11
12x13-14x15
16x17-18x19 mm

810 g

M40	122,00	1	024500040
MV40	39,50	1	024510040

M44

12



141 8-9-10-11-12
13-14-15-16
17-18-19 mm

1,3 kg

M44	309,00	1	024500044
MV44	39,50	1	024510044

M45

12



142 8-9-10-11-12
13-14-15-16
17-18-19 mm

1,3 kg

M45	352,00	1	024500045
MV45	39,50	1	024510045

M46

12



142SN 8-9-10-11-12
13-14-15-16
17-18-19 mm

1,4 kg

M46	415,00	1	024500046
MV46	39,50	1	024510046

M49

24

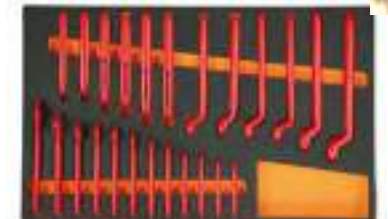

52MQ 7 - 8 - 10 - 11 - 12 - 13 - 14 - 15 - 16 - 17
- 19 - 22 mm
89MQ 7 - 8 - 10 - 11 - 12 - 13 - 14 - 15 - 16 - 17
- 19 - 22 mm

3,3 kg

M49	1.260,00	1	024500049
MV49	75,50	1	024510049

M50

8



96T 2-2,5-3-4-5
6-7-8 mm

1,1 kg

M50	143,00	1	024500050
MV50	53,50	1	024510051

M52



○ 96T 2,5-3-4-5-6 mm



330 g



M52	84,50	1	024500052
MV52	39,50	1	024510052

M53



○ 96TBP 2,5-3-4-5-6 mm



350 g



M53	89,50	1	024500053
MV52	39,50	1	024510052

M55



○ 97TTX T10-T15-T20-T25-T30



330 g



M55	93,50	1	024500055
MV55	39,50	1	024510055



M60



- 96T 2 - 2,5 - 3 - 4 - 5 - 6 - 7 - 8 - 10 mm
- 97BTX/SC8 T9 - T10 - T15 - T20 - T25 - T27 - T30 - T40
- 944BX 5-6-7-8-10-13 mm

1,9 Kg



M60	416,00	1	024500060
MV60	75,50	1	024510060

M62



- 97TTX T10 - T15 - T20 - T25 - T27 - T30 - T40 - T45 - T50
- 1032 180 mm
- 1034 170 mm
- 1036 175 mm
- 1038 175 mm
- 1177BM 140 mm
- 1188BM 125 mm
- 1257LP 2-2,5-3-3,5 mm
- 1257PH 0-00

2,3 kg



M62	505,00	1	024500075
MV62	75,50	1	024510075

M63



○ 952 7 - 8 - 10 - 12 - 13 - 14 - 17 - 19 mm

3,4 kg



M63	377,00	1	024500063
MV63	75,50	1	024510063

M65

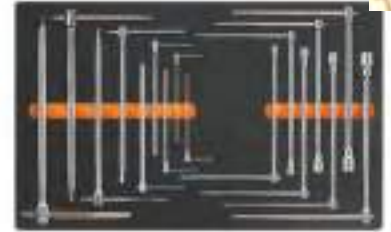

950 8 - 10 - 12 - 13 - 14 - 17 - 19 mm
951 2,5 - 3 - 4 - 5 - 6 - 8 - 10 - 12 - 14 mm

3,6 Kg



M65	580,00	1	024500065
MV65	75,50	1	024510065

M67



○ 950 7-8-10-12-13-17 mm

1,8 kg



M67	223,00	1	024500067
MV67	53,50	1	024510067

M69



○ 951 2,5-3-4-5-6-8-10-12-14 mm

1,8 kg



M69	329,00	1	024500069
MV69	53,50	1	024510069

M75



○ 933 7-8-9-10-11-12-13-14-15-16-17-18-19-21-22-24 mm

5,5 kg



M75	491,00	1	024500075
MV75	75,50	1	024510075



M78

17



80 6x7 - 8x9 - 10x11 - 12x13 - 14x15 - 16x17 - 18x19 mm

920/36A
965 450 mm
1052 240 mm
1058 175 mm
1481PL/A
1481PL/B
1481PL/C
1650 150 mm
1708/20
1716P

4,4 kg

M78	760,00	1	024500878
MV77	75,50	1	024510876

M79

6



80 8x9 - 10x11 - 12x13 - 14x15 16x17 - 18x19 mm

1,3 kg

M79	332,00	1	024500079
MV79	39,50	1	024510079

M82

29



○ 920A 10-11-12-13-14
15-16-17-18-19
20-21-22-23-24
26-27-30-32 mm
○ 920ME 5-6-8-10-12 mm
920AN/125 125 mm
920AN/250 250 mm
920/25
920/42 305 mm
⊕ 920/55

4,1 kg

M82	477,00	1	024500082
MV82	53,50	1	024510082

M83

24



○ 920A 10-11-12-13-14
15-16-17-18-19
20-21-22-23-24
26-27-30-32 mm
920AN/125 125 mm
920AN/250 250 mm
920/25 255 mm
920/42 305 mm
⊕ 920/55

3,7 kg

M83	373,00	1	024500083
MV83	53,50	1	024510083

M85

45



851SR 230 mm
● 860LP 0,5x3 - 0,6x4,5 -
0,8x5,5 - 1x5,5 -
1,2x6,5 mm
○ 860PE 2 - 2,5 - 3 - 4 - 5 - 6 - 8
- 10 mm
⊕ 860PH PH0 - PH1 - PH2 -
PH3 - PH4
⊕ 860PZ PZ1 - PZ2 - PZ3 - PZ4
⊕ 860TX T6 - T7 - T8 - T9 - T10
- T15 - T20 - T25 - T27
- T30 - T40
⊕ 860RTX T9 - T10 - T15 - T20
- T25 - T27 - T30 - T40
860/55 100 mm
882P 80 mm
892 ■ 1/4 - □ 1/4

450 g

M85	221,00	1	024500085
MV85	39,50	1	024510085

M86

46



○ 867PE 4-5-6-7-8-10-12 mm
○ 867PE/L 4-5-6-7-8-10-12 mm
○ 867XZN 5-6-8-10-12 mm
○ 867XZN/L 5-6-8-10-12 mm
⊕ 867TX T20 - T25 - T30 - T40
- T45 - T50 - T55
⊕ 867TX/L T25 - T30 - T40 - T45
- T50 - T55
⊕ 867RTX T20 - T25 - T30 - T40
- T45 - T50 - T55
867/1
867/2

1,4 kg

M86	159,00	1	024500086
MV86	39,50	1	024510086

M91

25



○ 900 4 - 4,5 - 5 - 5,5 - 6 - 7
- 8 - 9 - 10 - 11 - 12
- 13 - 14 mm
○ 900ME 2,5-3-4-5-6-8 mm
900/20 50 mm
900/21 150 mm
900/25 □ 1/4 - ■ 1/4
900BG/30
900/42
⊕ 900/55

560 g

M91	257,00	1	024500091
MV90	39,50	1	024510090

M92

22



○ 910A 6-7-8-9-10-11-12-13-
14-15-16-17-18-19-20-
21-22 mm
910/21 125 mm
910/22 250 mm
910/25
910/42
⊕ 910/55

1,5 kg

M92	288,00	1	024500092
MV92	39,50	1	024510092

M94

26



○ 900AS/L 3/16 - 7/32 - 1/4 - 9/32
- 5/16 - 11/32 - 3/8 -
7/16 - 1/2 - 9/16
○ 900AS 3/16 - 7/32 - 5/32 - 1/4
- 9/32 - 5/16 - 11/32
- 3/8 - 7/16 - 1/2 - 9/16
900AN 50-100mm
900/25
⊕ 900/55
900/42

930 g

M94	301,00	1	024500094
MV94	39,50	1	024510094

M96

22



○ 920A/AS 3/8 - 7/16 - 1/2 - 9/16
- 19/32 - 5/8 - 11/16
- 3/4 - 25/32 - 13/16 -
7/8 - 15/16 - 1 - 1.1/16
- 1.1/8 - 1.3/16 -
1.1/4
920/25
920AN 125-250mm
920/42
⊕ 920/55

3,8 kg

M96	385,00	1	024500096
MV96	53,50	1	024510096



- 895/1
- 895/3
- 895/6
- 900 4 - 4,5 - 5 - 5,5 - 6 - 7 - 8 - 9 - 10 - 11 - 12 - 13 - 14 mm
- 900L 5 - 6 - 7 - 8 - 9 - 10 - 11 - 12 - 13 mm
- 900ME 3-4-5-6-7 mm
- 900LP 0,8x4 - 1x5,5 - 1,2x6,5 - 1,2x8 mm
- ⊕ 900PH PH1-PH2-PH3-PH4
- ⊕ 900TX T10 - T15 - T20 - T25 - T27 - T30 - T40
- 900/20 50 mm
- 900/20L 100 mm
- 900/21 150 mm
- 900/25
- 900BG/30
- 900/42
- ⊕ 900/55
- 920A 8-10-11-12-13-14-15-16-17-18-19-20-21-22-23-24-26-27-28-30-32 mm
- 920/15
- 920/25
- 920AN/125 125 mm
- 920AN/250 250 mm
- 920/42
- ⊕ 920/55
- 920FTX 10 - 12 - 14 - 16 - 18 - 20 - 22 - 24 mm
- 920AL 10 - 12 - 13 - 14 - 15 - 16 - 17 - 18 - 19 - 21 - 22

6,7 Kg



M100	1.310,00	1	024500100
MV100	75,50	1	024510100



- 900 4 - 4,5 - 5 - 5,5 - 6 - 7 - 8 - 9 - 10 - 11 - 12 - 13 - 14 mm
- 900L 5 - 6 - 7 - 8 - 9 - 10 - 11 - 12 - 13 mm
- 96BPC/SC9 1,5-2-2,5-3-4-5-6-8-10 mm
- 895/1
- 895/3
- 895/6
- 900ME 3-4-5-6-7 mm
- 900LP 0,8x4 - 1x5,5 - 1,2x6,5 - 1,2x8 mm
- ⊕ 900PH PH1-PH2-PH3-PH4
- ⊕ 900TX T10 - T15 - T20 - T25 - T27 - T30 - T40
- 900/16 □ 1/4 - ■ 3/8
- 900/... 50-100-150 mm
- 900/25
- 900BG/30
- 900/42
- ⊕ 900/55
- 910A 6 - 7 - 8 - 9 - 10 - 11 - 12 - 13 - 14 - 15 - 16 - 17 - 18 - 19 - 20 - 21 - 22 mm
- 910/15 □ 3/8 - ■ 1/4
- 910/16 □ 3/8 - ■ 1/2
- 910/21 125 mm
- 910/22 250 mm
- 910/25
- 910/42
- ⊕ 910/55
- 920A 8 - 10 - 11 - 12 - 13 - 14 - 15 - 16 - 17 - 18 - 19 - 20 - 21 - 22 - 23 - 24 - 26 - 27 - 28 - 30 - 32 mm
- 920/15 □ 1/2 - ■ 3/8
- 920/25
- 920AN 125 - 250 mm
- 920/42
- ⊕ 920/55
- 956E 16-17,8-20,8 mm

7,7 kg



M105	1.430,00	1	024500871
MV105	75,50	1	024510871

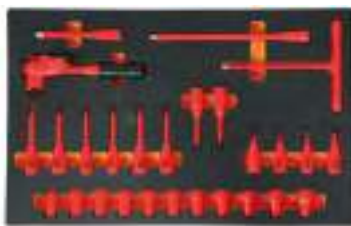

- 910MQ/PE 4-5-6-8 mm
- 910MQ/B 7 - 8 - 10 - 11 - 12 - 13 - 14 - 15 - 16 - 17 - 19 mm
- ⊕ 910MQ/TX T15 - T20 - T25 - T27 - T30 - T40
- 910MQ/XZN 8-10 mm
- 910MQ/21 125 mm
- 910MQ/22 250 mm
- 910MQ/T
- 910MQ/55

2,7 kg



M108	1.380,00	1	024500108
MV108	75,50	1	024510108



- ⊕ 850MQ
- ⊕ 860TX/A10
- 920MQ/A 8 - 9 - 10 - 11 - 12 - 13 - 14 - 15 - 16 - 17 - 18 - 19 - 20 mm
- 920MQ/PE 5-6-8-10-12 mm
- 920MQ/21 125 mm
- 920MQ/22 250 mm
- 920MQ/55A
- 943MQ 6-7-8-10 mm

3,1 kg



M110	1.390,00	1	024500110
MV110	75,50	1	024510110



- ⊕ 861TX ● 1/4-T6+T15
- ⊕ 866TX ● 5/16-T20+T55
- 895/1 ○ 1/4x□1/4
- 895/6 ○ 5/16x□1/2
- 900FTX □ 1/4-E4+E10
- 920FTX □ 1/2-E12+E24
- 920TX □ 1/2-T55L-T60-T70L

1,3 kg



M112	342,00	1	024500112
MV112	39,50	1	024510112



- ⊕ 666/20 40÷200 Nm
- 920A 13 - 14 - 15 - 16 - 17 - 18 - 19 - 20 - 21 - 22 - 24 - 26 - 27 - 30 - 32 mm
- 920FTX 12 - 14 - 16 - 18 - 20 - 22 - 24 mm
- 920PE 6 - 7 - 8 - 8L - 10 - 10L - 12 - 12L - 14 - 14L
- ⊕ 920TX T20 - T25 - T27 - T30 - T40 - T45 - T50 - T55 - T60 - T20L - T25L - T27L - T30L - T40L - T45L - T50L
- 920/21 125 mm
- 920/22 255 mm
- 920/25
- 920/42 305 mm
- ⊕ 920/55

7,8 Kg



M115	1.260,00	1	024500115
MV116	75,50	1	024510116



M120

75



- 920A 10-11-12-13-14-15-16-17-18-19-20-21
22-24-26-27-30-32 mm
- 920AN/125 125 mm
- 920AN/250 250 mm
- 920/25
- 920/42
- 920AL 10 - 12 - 13 - 14 - 15 - 16 - 17 - 18 - 19 -
22 - 24 - 27 - 30 - 32 mm
- ⊗ 920FTX 10 - 12 - 14 - 16 - 18 - 20 - 22 - 24 mm
- ⊗ 920/55
- 920PE 5 - 5L - 6 - 6L - 7 - 7L - 8 - 8L - 10 - 10L
- 12 - 12L - 14 - 14L
- ⊗ 920TX T20-T25-T27-T30-T40-T45-T50-T55-T60
T20L-T25L-T27L-T30L-T40L-T45L-T50L

6,9 Kg

12"

	€		
M120	1.410,00	1	024500120
MV120	75,50	1	024510120

M121

46



- 920BP 5L - 6L - 8L - 10L - 5XL - 6XL - 8XL mm
- ⊗ 920TX T20 - T25 - T27 - T30 - T40L - T45L
- T50L - T55L - T60L - T70L
- 920XZN 4 - 5 - 6 - 6L - 8 - 8L - 10 - 10L - 12 - 12L
- 14 - 14L - 16 - 18 mm
- ⊗ 920ES 7 - 9 - 10 - 11 - 12L - 14L - 16L - 7XL
- 9XL - 10XL - 11XL - 12XL - 14XL - 16XL
mm

920/36A

6,3 Kg

12"

	€		
M121	1.330,00	1	024500121
MV121	75,50	1	024510121

M125

68



- 910AL 8 - 9 - 10 - 11 - 12 - 13 - 14 - 15 - 16 - 17
- 19 - 21 - 22 mm
- 920PE 5-6-6L-7-8-8L-10-10L-12-12L mm
- ⊗ 920FTX E12 - E14 - E16 - E18 - E20 - E22 - E24
- ⊗ 920TX T20 - T25 - T27 - T30 - T30L - T40 - T40L
- T45 - T50 - T50L - T55 - T60 - T60L
- 920XZN 5 - 6 - 6L - 8 - 8L - 10 - 10L - 12L mm
- 920AL 10 - 12 - 13 - 14 - 15 - 16 - 17 - 18 - 19
- 21 - 22 - 23 - 24 - 27 - 30 - 32 mm

1692/5

7,9 kg

38" 12"

	€		
M125	1.380,00	1	024500872
MV125	75,50	1	024510872

M126

26



- 928A 19 - 21 - 22 - 24 - 26 - 27 - 28 - 30 - 32
- 34 - 35 - 36 - 38 - 41 - 46 mm
- 928ME 14-17-19-22 mm
- 928/15 □ 3/4 - ■ 1/2
- 928/16 □ 3/4 - ■ 1
- 928/21 200 mm
- 928/22 380 mm
- 928/25
- 928/42 450 mm
- ⊗ 928/55

12,4 kg

34"

	€		
M126	1.050,00	1	024500126
MV126	75,50	1	024510126

M127

23



- 728 19 - 21 - 22 - 24 - 27 - 30 - 32 - 33 - 34
- 35 - 36 - 38 - 40 - 41 - 46
- ⊗ 728FTX 20-22-24 mm
- 728/15 □ 3/4 - ■ 1/2
- 728/16 □ 3/4 - ■ 1
- 728/21 175 mm
- 728/22 250 mm
- 728/25

12,5 kg

34"

	€		
M127	1.010,00	1	024500127
MV127	75,50	1	024510127

M128

50



- 720 10 - 11 - 12 - 13 - 14 - 15 - 16 - 17 - 18
- 19 - 21 - 22 - 24 - 27 - 30 - 32 mm
- 720L 10 - 11 - 12 - 13 - 14 - 15 - 16 - 17 - 18
- 19 - 21 - 22 - 24 - 27 - 30 - 32 mm
- ⊗ 720TX T30-T40-T45-T50-T55
- 720ME 5 - 6 - 8 - 10 - 12 - 14 - 17 - 19 mm
- 720LC 17-19-21 mm
- 720/21 125 mm
- 720/25

8,9 kg

12"

	€		
M128	1.030,00	1	024500128
MV128	75,50	1	024510128

M129

13



- 1032 180 mm
- 1034 170 mm
- 1036 175 mm
- 1038 175 mm
- 1048N 250 mm
- 1052 240 mm
- ⊗ 1082BM 160 mm
- 1098 220 mm
- 1112 250 mm
- 1128BM
- 1150BM 180 mm
- 1166BM 160 mm
- 1168BM 160 mm

3,4 Kg

	€		
M129	498,00	1	024500129
MV138	75,50	1	024510138

M133

3



- ⊗ 1082G 160 mm
- 1150G 180 mm
- 1166G 160 mm

650 g

	€		
M133	93,00	1	024500133
MV133	39,50	1	024510133

M134

3



- ⊗ 1082GBM 160 mm
- 1150GBM 180 mm
- 1166GBM 160 mm

750 g

	€		
M134	119,00	1	024500134
MV134	39,50	1	024510134

M135



- ◄ 1082MQ 160 mm
- ▬ 1150MQ 180 mm
- 1166MQ 160 mm



750 g



M135	€ 198,00	1	024500135
MV135	€ 39,50	1	024510135

M136



- ◄ 1084BM 160 mm
- ▬ 1150BM 180 mm
- 1166BM 160 mm



750 g



M136	€ 135,00	1	024500136
MV131	€ 39,50	1	024510131

M137



- ◄ 1084 160 mm
- ▬ 1150 180 mm
- 1166 160 mm



650 g



M137	€ 110,00	1	024500137
MV132	€ 39,50	1	024510132

M145



- 1032 180 mm
- 1034 170 mm
- 1036 175 mm
- 1038 175 mm



640 g



M145	€ 148,00	1	024500145
MV145	€ 39,50	1	024510145

M153



- 1048N 250 mm
- 1052 240 mm



1 kg



M153	€ 107,00	1	024500153
MV154	€ 39,50	1	024510154

M161



- 1128MQ
- 1048MQ 250 mm
- ◄ 1082MQ 160 mm
- ▬ 1150MQ 180 mm
- ▬ 1162MQ 160 mm
- ▬ 1164MQ 160 mm
- ⊕ 1272MQ PH0x60 - PH1x80 - PH2x100 - PH3x150 mm
- 1274MQ 2,5x75 - 3x100 - 4x100 - 5,5x125 mm
- 1777MQ/U



3,0 kg



M161	€ 590,00	1	024500161
MV161	€ 75,50	1	024510161

M162



- ⊕ 1241 5,5x100 - 6,5x125 - 8x150 - 10x200 mm
- ⊕ 1242 PH1x100 - PH2x100 - PH3x150 - PH4x200 mm



1,4 kg



M162	€ 163,00	1	024500162
MV162	€ 53,50	1	024510162



M166



⊕ 860MIX/A31

- ⊕ 1048N 250 mm
- ◄ 1082BM 160 mm
- ▬ 1150BM 180 mm
- ▬ 1162BM 160 mm
- 1290 3x75 - 4x100 - 5,5x100 - 6,5x150 - 8x150 mm
- 1290N 6,5x30 mm
- ⊕ 1292 4,5x80 - 6x100 - 8x150 mm
- ⊕ 1292N 6x30 mm
- ⊕ 1297TX T20-T25-T27-T30

2,9 kg



M166	€ 515,00	1	024500879
MV880	€ 75,50	1	024510880

M170



- 1290 2,5x50 - 3x75 - 3,5x100 - 4x125 - 5,5x100 - 5,5x150 - 6,5x150 mm



500 g



M170	€ 88,50	1	024500170
MV170	€ 39,50	1	024510170

M172



- ⊕ 1292 PH0x60 - PH0x100 - PH1x80 - PH1x120 - PH2x100 - PH2x150 mm



450 g



M172	€ 80,00	1	024500172
MV172	€ 39,50	1	024510172



M174

6



1297TX T8 - T10 - T15 - T20 - T25 - T30

450 g



M174	118,00	1	024500174
MV174	39,50	1	024510174

M180

7



1290 3x75
4x100
5,5x150
6,5x150 mm
1292 PH0x60
PH1x80
PH2x100 mm

500 g



M180	91,50	1	024500180
MV180	39,50	1	024510180

M195

25

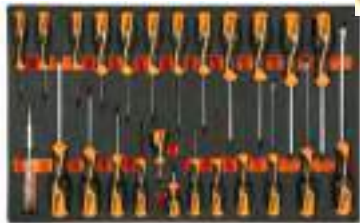

1260 2,5x50 - 3x75 - 4x100 - 5,5x125 - 6,5x150 - 8x200 mm
1260N 4x30 mm
1262 PH0x60 - PH1x80 - PH2x100 - PH3x150 mm
1262N PH1x30 mm
1267TX T6 - T7 - T8 - T9 - T10 - T15 - T20 - T25 - T27 - T30 - T40 - T45
1253 3,5x100 mm

2,3 kg



M195	355,00	1	024500195
MV195	75,50	1	024510195

M201

6



1260 3x75 - 4x100 - 6,5x150 mm
1262 PH0x60 - PH1x80 - PH2x100 mm

500 g



M201	91,00	1	024500201
MV201	39,50	1	024510201

M204

6



1267TX T8 - T10 - T15 - T20 - T25 - T30

450 g



M204	89,50	1	024500204
MV204	39,50	1	024510204

M208

10



1260 3x75
3,5x100
4x125
5,5x150
6,5x150 mm
1262 PH0x60
PH1x80
PH2x100 mm
4x30 mm
1260N 4x30 mm
1262N PH1x30 mm

750 g



M208	103,00	1	024500208
MV208	53,50	1	024510208

M209

10



1260N 4x30 mm
1264 2,5x60 - 3x100 - 4x125 - 5x150 - 6,5x150 mm
1262 PH0x60 - PH1x80 - PH2x100 mm
1262N PH1x30 mm

820 g



M209	101,00	1	024500209
MV208	53,50	1	024510208

M213

25



1201E 2,5x50 - 3x75 - 4x100 - 5,5x125 - 6,5x150 - 8x200 mm
1201EN 4x30 mm
1202E PH0x60 - PH1x80 - PH2x100 - PH3x150 mm
1202EN PH1x30 mm
1207E/TX T6 - T7 - T8 - T9 - T10 - T15 - T20 - T25 - T27 - T30 - T40 - T45
1253 3,5x100 mm

1,8 Kg



M213	239,00	1	024500213
MV210	75,50	1	024510210

M214

7



1201E 2,5x50 - 3x75 - 3,5x100 - 4x125 - 5,5x100 - 5,5x150 - 6,5x150 mm

500 g



M214	49,50	1	024500214
MV211	39,50	1	024510211

M216

6



1202E PH0x60 - PH1x80 - PH1x120 - PH2x100 - PH2x150 - PH3x150 mm

450 g



M216	54,00	1	024500216
MV212	39,50	1	024510212

M217

7



1207E/TX T6 - T7 - T8 - T9 - T10 - T15 - T20

500 g



M217	69,00	1	024500217
MV215	39,50	1	024510215



M218



- 1201E 3x75
4x100
5,5x150
6,5x150 mm
- ⊕ 1202E PH0x60
PH1x80
PH2x100 mm

📦 500 g



M218	€ 52,50	1	024500218
MV220	€ 39,50	1	024510220

M219



- ⊕ 1202E 3x60 - 4,5x80 - 6x100 mm
- 1204E 3x75 - 4x100 - 5x150 - 6,5x150 mm

📦 590 g



M219	€ 52,50	1	024500219
MV220	€ 39,50	1	024510220

M222



- ⊕ 1272MQ PH0x60 mm
- ⊕ 1272MQF PH1x80 - PH2x100 mm
- 1274MQF 3,5x100 - 4,5x100 - 5,5x125 - 6,5x150 mm

📦 540 g



M222	€ 150,00	1	024500222
MV222	€ 39,50	1	024510222

M226



- 1274MQ 3x100
4x100
5,5x125
6,5x150 mm
- ⊕ 1272MQ PH0x60
PH1x80
PH2x100 mm

📦 500 g



M226	€ 114,00	1	024500226
MV226	€ 39,50	1	024510226

M227



- 944BX 6-7-8-10-13 mm

📦 420 g



M227	€ 140,00	1	024500227
MV227	€ 39,50	1	024510227

M230



- 30 Ø 2-3-4 mm
- 31 Ø 2-3-4-5-6-8 mm
- 32 Ø 4 mm
- 34 150 mm
- 35 200-250 mm
- 36 125 mm
- 1370 500 g
- 1390 Ø 35 mm
- 1692 3 m
- 1712TF
- 1719BMA/Q 200 mm
- ▲ 1719BMA/T 200 mm
- 1719BMA/P 200 mm
- ▶ 1719BMA/M 200 mm
- 1719BMA/R 200 mm
- 1737NX
- 1771 18 mm

📦 3,2 Kg



M230	€ 457,00	1	024500230
MV230	€ 75,50	1	024510230

M231



- 31 2-3-4-5-6-8 mm
- 32 4 mm
- 34 125-150-175 mm
- 36 125 mm
- 1370 500-1000 g
- 1390 Ø 35 mm
- 1712TF 590 mm
- 1715 670 mm
- 1719BMA8/Q 200 mm
- ▲ 1719BMA8/T 200 mm
- 1719BMA8/P 200 mm
- ▶ 1719BMA8/M 200 mm
- 1719BMA8/R 200 mm
- 1737NX

📦 4,7 kg



M231	€ 441,00	1	024500877
MV231	€ 75,50	1	024510877

M234



- 35 100-200 mm
- 1370 300 g
- 1390 Ø 35 mm

📦 1,3 kg



M234	€ 115,00	1	024500234
MV232	€ 39,50	1	024510232

M236



- 1719BMA/Q 200 mm
- ▲ 1719BMA/T 200 mm
- 1719BMA/P 200 mm
- ▶ 1719BMA/M 200 mm
- 1719BMA/R 200 mm

📦 870 g



M236	€ 114,00	1	024500236
MV236	€ 39,50	1	024510236



M237

4



35 100-200 mm
1370T 300 mm
1390N Ø 35 mm

1,3 kg



M237	126,00 €	1	024500237
MV232	39,50 €	1	024510232

M240

7



31BM Ø 2-3-4-5-6-8 mm
32 Ø 4 mm

850 g



M240	150,00 €	1	024500240
MV240	39,50 €	1	024510240

M264

16



1491 Ø 65+110 mm
1494 10 mm
1494E Ø 8-9-10-11-12-14-17 mm
1494Q Ø 8-9,5-12-13 mm
1494T Δ 9,5
1494XZN Ø 16
1496C 8x 10 mm

2,1 kg



M264	266,00 €	1	024500264
MV264	39,50 €	1	024510264

Beta

QUALITY TOOLS

M284

9



1128BMX
1130BMX
1719BMA...Q 200 mm
1719BMA...P 200 mm
1719BMA...M 200 mm
1719BMA...R 200 mm
1726BM 400 mm
1728BM (5)
1771BM 170 mm
1778V18 185 mm

2,4 Kg



M284	269,00 €	1	024500284
MV284	75,50 €	1	024510284

M292

4



111E 250 mm
1128BMX
1692/5 5 m
1771 170 mm

500 g



M292	129,00 €	1	024500292
MV293	39,50 €	1	024510293

M294

4



1692/5 5 m
1725CR 260 mm
1771 18 mm
1771RL

500 g



M294	88,00 €	1	024500294
MV294	39,50 €	1	024510294

M295

4



1650
1682 L=300 mm
1707
1708/20

450 g



M295	130,00 €	1	024500295
MV295	39,50 €	1	024510295

M305

14



1927B
720 12-13-14-15-16-17
18-19-21-22
24-27 mm
720/21

4,2 kg

12"



M305	451,00 €	1	024500305
MV305	53,50 €	1	024510305

M310

14



1927CD
720 12-13-14-15-16-17
18-19-21-22
24-27 mm
720/21

4,0 kg

12"



M310	680,00 €	1	024500310
MV310	53,50 €	1	024510310

Beta

Beta



M400



- 3932U
- 3935 120 mm
- 3937 170 mm
- 3952 13 - 14 - 15 - 16 - 17 - 18 - 19 mm
- 3961 3,2
- 3961 3,3
- 3961 3,5
- 3961U 3,2 - 4,0 mm
- 3969 200 mm (x2)
- 3969K3 113 mm
- 3973/1
- 3973/2
- 3973/3
- 3973/4
- 3984/1 Ø35 mm
- 3984/2 Ø22,8 mm
- 3984/3 Ø23,5 mm
- 3984/4 Ø23 mm
- 3991 222 mm
- 3992 234 mm

3,1 kg

M400	€ 680,00	1 024500400
MV400	€ 75,50	1 024510400

M401



- 3921 440 mm
- 3948
- 3953
- 3955 30x32 - 32x36 mm
- 3967 289 mm
- 3971

2,7 kg

M401	€ 411,00	1 024500401
MV401	€ 75,50	1 024510401



RSC22
RSC23
RSC23C
G27S

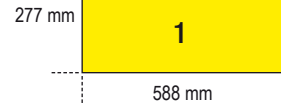
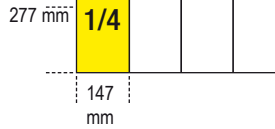

543
559

C41S
C41H



543

MC10



- 42 6-7-8-9-10-11-12
13-14-15-16-17
18-19-21-22 mm
- 96/SC9 1,5 - 2 - 2,5 - 3 - 4 - 5 - 6 - 8 - 10 mm
- ≡ 1084BM 160 mm
- ≡ 1150G 180 mm
- 1166G 160 mm
- 1201E 3,5x100 - 5,5x150 - 6,5x150 mm
- 1202E PH0x60 - PH1x80 - PH2x100 mm

3,5 kg

MC10	€ 427,00	1 027500011
MCV10	€ 53,50	1 027510010

MC12



- 42 6 - 7 - 8 - 9 - 10 - 11 - 12 - 13 - 14 - 15 - 16 - 17
- 18 - 19 - 21 - 22 mm
- 96/SC9 1,5 - 2 - 2,5 - 3 - 4 - 5 - 6 - 8 - 10 mm
- 1692/5 5 m

2,2 kg

MC12	€ 282,00	1 041500012
MCV11	€ 53,50	1 041510011

MC20

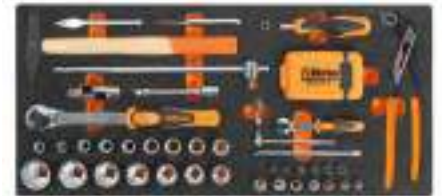

- 860MIX/A31
- 895/1
- 1048N 250 mm
- 1370 300 g
- 32 Ø 4 mm
- 36 Ø 4 mm
- 900 4 - 4,5 - 5 - 5,5 - 6 - 7 - 8 - 9 - 10 - 11 - 12 - 13 - 14 mm
- 900/21 150 mm
- 900/25
- 900BG/30C
- 900/42
- 900/55
- 920A 10 - 11 - 12 - 13 - 14 - 15 - 16 - 17 - 18 - 19 - 21 - 22 - 24
- 27 - 30 - 32 mm

- 920/25
- 920AN/125 125 mm
- 920/42
- 920/55

6 kg

MC20	€ 665,00	1 027500020
MCV20	€ 53,50	1 027510021

MC21



- 920A 10 - 11 - 12 - 13 - 14 - 15 - 16 - 17 - 18 - 19 - 20
- 21 - 22 - 23 - 24 - 26 - 27 - 30 - 32 mm
- 920/25
- 920/42
- 920/55
- 920AN 125-250 mm

4,3 kg

MC21	€ 373,00	1 041500021
MCV21	€ 53,50	1 041510021





C35

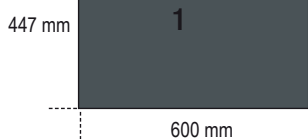

544÷546



MB12

30



- 42 6-7-8-9-10-11-12-13-14-15-16-17-18-19-20-21-22-24-27-30-32mm
- 55 6x7-8x9-10x11
12x13-14x15
16x17-18x19
20x22mm
250mm

1048N
5,4 kg



MB12	€ 650,00	1	024504212
MBV13	€ 205,00	1	024524213

MB37

52



- 920A 10-11-12-13-14-15-16-17-18-19-20-21-22-23-24-26-27-30-32mm
- 920/21 125mm
- 920/22 150mm
- 920/25
- 920/42
- ⊗ 920/55
- 111E 250mm
- 1052 240mm
- ⌘ 1084BM 160mm
- ≡ 1150BM 180mm
- 1166BM 160mm
- 1032 180mm
- 1034 170mm
- 1036 175mm
- 1038 175mm
- 900 4-4,5-5-5,5-6-7-8-9-10-11-12-13-14mm
- 900/20 50mm
- 900/21 150mm
- 900/25
- 900BG/30
- ⊗ 900/55
- 900/42

7,0 kg



MB37	€ 1.010,00	1	024504237
MBV40	€ 205,00	1	024524240

MB38

80



- 96T 2-2,5-3-4-5-6-7-8 mm
- 851SR 230mm
- 860LP 0,5x3-0,6x4,5-0,8x5,5-1x5,5-1,2x6,5 mm
- 860PE 2-2,5-3-4-5-6-8-10 mm
- ⊕ 860PH PH0 - PH1 - PH2 - PH3 - PH4
- ⊕ 860PZ PZ1 - PZ2 - PZ3 - PZ4
- ⊗ 860RTX T9 - T10 - T15 - T20 - T25 - T27 - T30 - T40
- ⊗ 860TX T6 - T7 - T8 - T9 - T10 - T15 - T20 - T25 - T27 - T30 - T40
- 860/55 100mm
- 882P
- 892/0
- 920A 10-11-12-13-14-15-16-17-18-19-20-21-22-23-24-26-27-30-32mm
- 920/21 125mm
- 920/22 255mm
- 920/25
- 920/42
- ⊗ 920/55
- ⌘ 1084BM 160mm
- ≡ 1150BM 180mm
- 1166BM 160mm

5,9 kg



MB38	€ 870,00	1	024504238
MBV35	€ 205,00	1	024524235

MB39

39



- 920A 10-11-12-13-14-15-16-17-18-19-20-21-22-23-24-26-27-30-32mm
- 920/21 125mm
- 920/22 255mm
- 920/25
- 920/42
- ⊗ 920/55
- 920PE 5-6-8-10-12 mm
- 1032 180mm
- 1034 170mm
- 1036 175mm
- 1038 175mm
- 35 200mm
- ⌘ 1084BM 160mm
- ≡ 1150BM 180mm
- 1166BM 160mm
- 1370 500g
- 1390 35mm

7,2 kg



MB39	€ 845,00	1	024504239
MBV36	€ 205,00	1	024524236

MB44

34



- 1260 2,5x50-3x75-3,5x100-4x100-5,5x125-6,5x150-8x200 mm
- 1260N 4x30-6,5x30 mm
- ⊕ 1262 PH0x60 - PH0x100 - PH1x80 - PH1x120 - PH2x100 - PH2x150 - PH3x150 mm
- ⊕ 1262N PH1x30-PH2x30 mm
- 1253
- 96BPC/SC9 951 2,5-3-4-5-6-8 mm

2,8 kg



MB44	€ 432,00	1	024504244
MBV44	€ 205,00	1	024524244

MB45

29

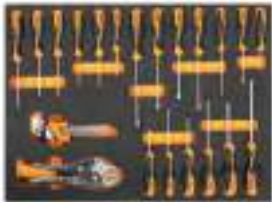

- 1260 2,5x50 - 3x75 - 3,5x100 - 4x100 - 5,5x100 - 5x125 - 6,5x150 mm
- ⊕ 1262 PH0x60 - PH0x100 - PH1x80 - PH1x120 - PH2x100 - PH2x150 mm
- ⊕ 1267TX T8 - T10 - T15 - T20 - T25 - T30
- 1052 240 mm
- 96BPC/SC9

2,8 kg



MB45	€ 320,00	1	024504245
MBV45	€ 205,00	1	024524245

MB46

29



- 1260 3x75 - 4x100 - 5,5x125 - 6,5x150 mm
- ⊕ 1262 PH0x60 - PH1x80 - - - PH2x100 mm
- ⊕ 1267TX T8 - T10 - T15 - T20 - T25 - T30
- 96BPC/SC9
- 96T 2-2,5-3-4-5-6
- 1052 240 mm

2,8 kg



MB46	€ 359,00	1	024504246
MBV46	€ 205,00	1	024524246

MB47

48



- 1260 3x75 - 4x100 - 5,5x125 - 6,5x150 mm
- ⊕ 1262 PH0x60 - PH1x80 - - - PH2x100 mm
- 1260N 4x30 mm
- ⊕ 1262N PH1x30 mm
- 96T 2,5-3-4-5-6-8 mm
- 96BPC/SC9
- 920A 10 - 11 - 12 - 13 - 14 - 15 - 16 - 17 - 18 - 19 - 20 - 21 - 22 - 23 - 24 - 26 - 27 - 30 - 32 mm
- 920/21 125 mm
- 920/22 250 mm
- 920/25
- 920/42
- ⊕ 920/55

5,6 kg

12"



MB47	€ 690,00	1	024504247
MBV47	€ 205,00	1	024524247

MB56

15



- 1719BMA/Q 200 mm
- ▲ 1719BMA/T 200 mm
- 1719BMA/P 200 mm
- ▶ 1719BMA/M 200 mm
- 1719BMA/R 200 mm
- 1032 180 mm
- 1034 170 mm
- 1036 175 mm
- 1038 175 mm
- 1370T 300 g
- 1390N Ø 35 mm
- 35 200 mm
- 1692 5 mt
- 1725CR 260 mm
- 1771 18 mm

3,7 kg



MB56	€ 413,00	1	024504256
MBV56	€ 205,00	1	024524256

MB58

17



- 31 Ø 2-3-4-5-6 mm
- 32 Ø 4 mm
- 35 200 mm
- 1112 250 mm
- 1128BMX
- 1370 500 g
- 1390 Ø 45 mm
- 1719BMA...Q 200 mm
- ▲ 1719BMA...T 200 mm
- 1719BMA...P 200 mm
- ▶ 1719BMA...M 200 mm
- 1719BMA...R 200 mm
- 1726 440 mm

4,5 kg



MB58	€ 413,00	1	024504258
MBV55	€ 205,00	1	024524255



MB59

15



- 1719BMA...Q 200 mm
- ▲ 1719BMA...T 200 mm
- 1719BMA...P 200 mm
- ▶ 1719BMA...M 200 mm
- 1719BMA...R 200 mm
- 31 Ø 4-6 mm
- 32 Ø 4 mm
- 35 125-200 mm
- 1370 300 g
- 1390 Ø 35 mm
- 1692 5 mt
- 1725 420 mm
- 1833XS/2

3,4 kg



MB59	€ 344,00	1	024504259
MBV57	€ 205,00	1	024524257

MB65

16

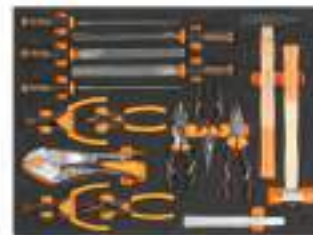

- 1719BMA...Q 200 mm
- 1719BMA...P 200 mm
- 1719BMA...T 200 mm
- 1719BMA...M 200 mm
- 1719BMA...R 200 mm
- 35 200 mm
- 1032 180 mm
- 1034 170 mm
- 1036 175 mm
- 1038 175 mm
- 1052 240 mm
- 1084BM 160 mm
- 1150BM 180 mm
- 1166BM 160 mm
- 1370 500 g
- 1390 Ø 35 mm

4,8 kg



MB65	€ 535,00	1	024504265
MBV61	€ 205,00	1	024524261

MB63

60



- 96BPC/SC9
- 1250 4x125 mm
- ⊕ 1251 PH1x125 mm
- 1253
- 943MQ 5,5-6-7-8-10-13 mm
- ⊕ 1272MQ PH0x60 - PH1x80 - PH2x100 - PH3x150 mm
- 1274MQ 2,5x75 - 3x100 - 4x100 - 5,5x125 - 6,5x150 - 8x175 mm
- 860LP 0,5x3 - 0,6x4 - 0,8x5,5 - 1,0x5,5 - 1,2x6,5 mm
- 860PE 2 - 2,5 - 3 - 4 - 5 - 6 - 8 - 10 mm
- ⊕ 860PH PH0 - PH1 - PH2 - PH3 - PH4
- ⊕ 860PZ PZ1 - PZ2 - PZ3 - PZ4
- ⊕ 860RTX T9 - T10 - T15 - T20 - T25 - T27 - T30 - T40
- 882MSR 50 ○ 1/4 ● 1/4
- 850MQ

3,2 kg



MB63	555,00	1	024504263
MBV63	205,00	1	024524263

MB64

20



- 55 6x7-8x9-10x11 - 12x13-14x15 - 16x17-18x19 - 20x22 mm
- 1048MQ 250 mm
- 1082MQ 140 mm
- 1128BSX
- 1132MQ 230 mm
- 1142MQ 160 mm
- 1150MQ 180 mm
- 1166MQ 160 mm
- 1168MQ 160 mm
- 110MQ 250 mm
- 1777MQ
- 993MQ
- 1602

4,1 kg



MB64	990,00	1	024504264
MBV62	205,00	1	024524262



C45PRO

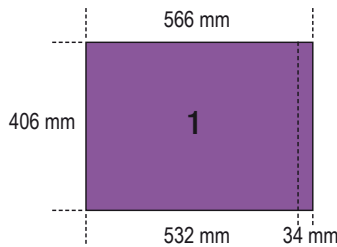

546

MM11

30

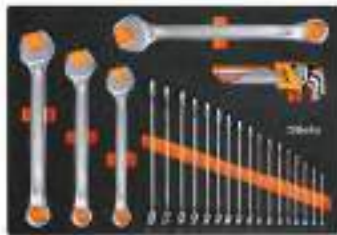

- 42 6 - 7 - 8 - 9 - 10 - 11 - 12 - 13 - 14 - 15 - 16 - 17 - 18 - 19 - 20 - 21 - 22 - 24 - 27 - 30 - 32 mm
- 96BPC/SC9 1,5 - 2 - 2,5 - 3 - 4 - 5 - 6 - 8 - 10 mm

4,5 kg



MM11	442,00	1	024580011
MMV10	75,50	1	024590010

MM26

34



- 42 6 - 7 - 8 - 9 - 10 - 11 - 12 - 13 - 14 - 15 - 16 - 17 - 18 - 19 - 21 - 22 - 24 - 27 mm
- 111E 250 mm
- 123Q1/4
- 123Q3/8
- 123Q1/2
- 142 8 - 9 - 10 - 11 - 12 - 13 - 14 - 15 - 16 - 17 - 18 - 19 mm

4,3 kg



MM26	720,00	1	024580026
MMV26	75,50	1	024590026

MM30

31

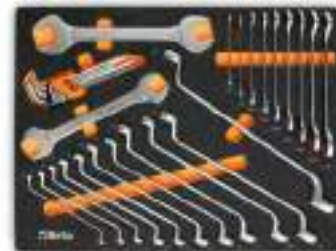

- 55 6x7-8x9-10x11-12x13-14x15-16x17 - 18x19-20x22-21x23-24x27-30x32 mm
- 90 6x7-8x9-10x11-12x13-14x15-16x17 - 18x19-20x22-21x23-24x27-30x32 mm
- 96BPC/SC9 1,5 - 2 - 2,5 - 3 - 4 - 5 - 6 - 8 - 10 mm

4,9 kg



MM30	476,00	1	024580030
MMV30	75,50	1	024590030

MM60

23



- 96T 2 - 2,5 - 3 - 4 - 5 - 6 - 7 - 8 - 10 mm
- 97BTX/SC8 T9-T10-T15-T20-T25-T27-T30-T40
- 944BX 5-6-7-8-10-13 mm

2,2 Kg



MM60	444,00	1	024580060
MMV60	75,50	1	024590060

MM63

8



- 952 7 - 8 - 10 - 12 - 13 - 14 - 17 - 19 mm

3,4 kg



MM63	410,00	1	024580063
MMV63	75,50	1	024590063





- 895/1
- 895/3
- 895/6
- 900 4 - 4,5 - 5 - 5,5 - 6 - 7 - 8 - 9 - 10 - 11 - 12 - 13 - 14 mm
- 900L 5 - 6 - 7 - 8 - 9 - 10 - 11 - 12 - 13 mm
- 900ME 3-4-5-6-7 mm
- 900LP 0,8x4 - 1x5,5 - 1,2x6,5 - 1,2x8
- ⊕ 900PH PH1-PH2-PH3-PH4
- ⊗ 900TX T10 - T15 - T20 - T25 - T27 - T30 - T40
- 900/20 50 mm
- 900/20L 100 mm
- 900/21 150 mm
- 900/25
- 900BG/30
- 900/42
- ⊗ 900/55
- 920A 8-10-11-12-13-14-15-16-17-18-19-20
21-22-23-24-26-27-28-30-32 mm
- 920/15
- 920/25
- 920AN/125 125 mm
- 920AN/250 250 mm
- 920/42
- ⊗ 920/55
- 920/42 10 - 12 - 14 - 16 - 18 - 20 - 22 - 24 mm
- 920AL 10 - 12 - 13 - 14 - 15 - 16 - 17 - 18 - 19 - 21 - 22

6,7 Kg



MM100	1.310,00	1	024580100
MMV100	75,50	1	024590100



- 1032 180 mm
- 1034 170 mm
- 1036 175 mm
- 1038 175 mm
- 1048N 250 mm
- 1052 240 mm
- ⌘ 1082BM 160 mm
- 1098 220 mm
- 1128BM
- 1150BM 180 mm
- 1166BM 160 mm

2,9 Kg



MM129	464,00	1	024580129
MMV129	75,50	1	024590129



- 1201E 2,5x50 - 3x75 - 4x100 - 5,5x125 - 6,5x150 - 8x200 mm
- 1201EN 4x30 mm
- ⊕ 1202E PH0x60 - PH1x80 - PH2x100 - PH3x150 mm
- ⊕ 1202EN PH1X30 mm
- ⊗ 1207E/TX T6 - T7 - T8 - T9 - T10 - T15 - T20 - T25 - T27 - T30 - T40 - T45
- 1253

2,1 kg



MM210	239,00	1	024580211
MMV210	75,50	1	024590210



- 895/1 ○1/4-□1/4
- 895/3 ○1/4-□3/8
- 895/6 ○5/16-□1/2
- 900 4 - 4,5 - 5 - 5,5 - 6 - 7 - 8 - 9 - 10 - 11 - 12 - 13 - 14 mm
- 900L 5 - 6 - 7 - 8 - 9 - 10 - 11 - 12 - 13 mm
- 900ME 3-4-5-6-7 mm
- 900LP 0,8x4 - 1x5,5 - 1,2x6,5 - 1,2x8
- ⊕ 900PH PH1-PH2-PH3-PH4
- ⊗ 900TX T10 - T15 - T20 - T25 - T27 - T30 - T40
- 900/16
- 900/... 50-100-150 mm
- 900/25
- 900BG/30 176 mm
- 900/42 115 mm
- ⊗ 900/55 125 mm
- 910A 6 - 7 - 8 - 9 - 10 - 11 - 12 - 13 - 14 - 15 - 16 - 17 - 18 - 19 - 20 - 21 - 22 mm
- 910/15 □3/8-■1/4
- 910/16 □3/8-■1/2
- 910/21 125 mm
- 910/22 250 mm
- 910/25
- 910/42 210 mm
- ⊗ 910/55 200 mm
- 920A 8 - 10 - 11 - 12 - 13 - 14 - 15 - 16 - 17 - 18 - 19 - 20 - 21 - 22 - 23 - 24 - 26 - 27 - 28 - 30 - 32 mm
- 920/15 □1/2-■3/8
- 920/25
- 920AN 125-250 mm
- 920/42 305 mm
- ⊗ 920/55 275 mm
- 956E 16 mm (5/8") - 17,8 (11/16") - 20,8 (13/16")

7,2 kg



MM105	1.380,00	1	024580105
MMV105	75,50	1	024590105

MM230

25



- 30 Ø 2-3-4 mm
- 31 Ø 2-3-4-5-6-8 mm
- 32 Ø 4 mm
- 34 150 mm
- 35 200-250 mm
- 36 125 mm
- 1370 500 g
- 1390 Ø 35 mm
- 1692 3 m
- 1712TF
- 1719BMA...Q 200 mm
- 1719BMA...T 200 mm
- 1719BMA...P 200 mm
- 1719BMA...M 200 mm
- 1719BMA...R 200 mm
- 1737NX
- 1771

3,2 Kg



MM230	479,00	1	024580230
MMV230	75,50	1	024590230

MM400

29



- 3932U
- 3935 120 mm
- 3937 170 mm
- 3952 13 - 14 - 15 - 16 - 17 - 18 - 19 mm
- 3961 3,2
- 3961 3,3
- 3961 3,5
- 3961U 3,2 - 4,0 mm
- 3969 200 mm (x2)
- 3969K3 113 mm
- 3973/1
- 3973/2
- 3973/3
- 3973/4
- 3984/1
- 3984/2
- 3984/3
- 3984/4
- 3991 222 mm
- 3992 234 mm

3,1 kg



MM400	680,00	1	024580400
MMV400	75,50	1	024590400

MM401

7



- 3921 440 mm
- 3948
- 3953
- 3955 30x32 mm - 32x36 mm
- 3967 289 mm
- 3971

2,7 kg



MM401	411,00	1	024580401
MMV401	75,50	1	024590401

VPM0

Tabuleiro maleável

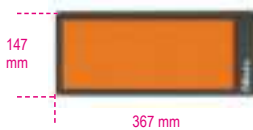

VPM0	31,00	1	088870350
------	-------	---	-----------

VPM3

Tabuleiro maleável

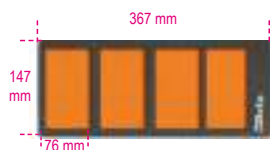

VPM3	31,00	1	088870353
------	-------	---	-----------

VPM7

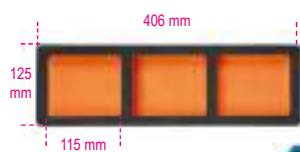

VPM7	32,50	1	088870356
------	-------	---	-----------

VPM8



VPM8	25,00	1	088870357
------	-------	---	-----------

VPM9



VPM9	24,50	1	088870358
------	-------	---	-----------

VPM7-C

tabuleiro maleável com 3 bandejas

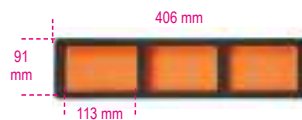

VPM7C	38,00	1	088870360
-------	-------	---	-----------



Módulos para ferramentas rígidos, série T



Composições de ferramentas em módulos para todos os modelos de carros com gavetas e para os carros.

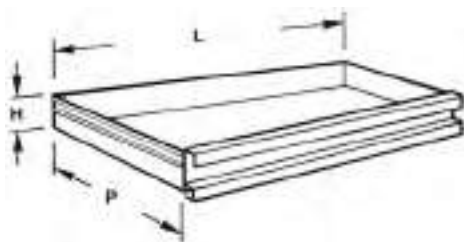

H mm	LxP mm
70	588x367

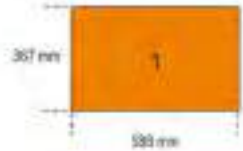
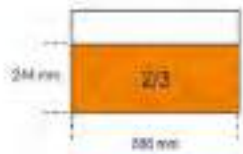
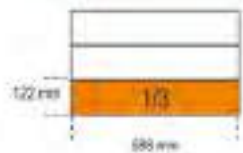
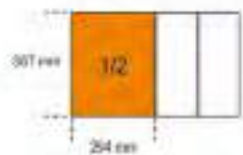
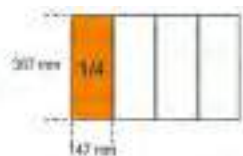

T01



42 6-7-8-10-11-12-13
14-16-17-18-19-21
22-24-27-30 mm



2,7 kg



	€	Hand	Computer
T01	289,00	1	024240001
TV10	38,50	1	024000400

T05



42 6-7-8-9-10-11-12
13-14-15-16-17
18-19-20-21 mm



1,5 kg



	€	Hand	Computer
T05	220,00	1	024240005
TV15	29,50	1	024000445

T06



42 22-24-27-30-32 mm



2,1 kg



	€	Hand	Computer
T06	157,00	1	024240006
TV16	29,50	1	024000446

T18



42MP 6-7-8-9-10-11-12
13-14-15-16-17
18-19-20-21 mm



1,5 kg



	€	Hand	Computer
T18	322,00	1	024240018
TV15	29,50	1	024000445

T19



42MP 22-24-27-30-32 mm



2,1 kg



	€	Hand	Computer
T19	212,00	1	024240019
TV16	29,50	1	024000446

T22



42AS 5/16-3/8-7/16-1/2
9/16-5/8-11/16-3/4
3/32-1/8-5/32-3/16
1/4-5/16-3/8



1 kg



	€	Hand	Computer
T22	173,00	1	024240022
TV20	29,50	1	024000488

T23



42INOX 8-10-11-12-13-14-15-17-19 mm
96BPINOX 2,5-3-4-5-6-8-10 mm



1 kg



	€	Hand	Computer
T23	300,00	1	024240023
TV23	29,50	1	024249906

T31



31 Ø 2-3-4-5-6 mm
32 Ø 4 mm
55 6x7-8x9-10x11
12x13-14x15
16x17-18x19
20x22-21x23
24x26-27x29
30x32 mm
96N/SC9 1,5+10 mm



3 kg



	€	Hand	Computer
T31	244,00	1	024240031
TV30	38,50	1	024000401

T33



55 6x7-8x9-10x11
12x13-14x15
16x17-18x19
20x22 mm
○96/SC9 1,5+10 mm

1 kg



T33	104,00	1	024240033
TV20	29,50	1	024000488

T34



55MP 6x7-8x9-10x11
12x13-14x15
16x17-18x19
20x22 mm
○96/SC9 1,5+10 mm

1 kg



T34	131,00	1	024240034
TV20	29,50	1	024000488

T40



90 6x7-8x9-10x11
12x13-14x15
16x17-18x19 mm

810 g



T40	114,00	1	024240040
TV40	29,50	1	024000456

T41



90 20x22-21x23
24x26-25x28
27x29 mm

1,5 kg



T41	170,00	1	024240041
TV41	29,50	1	024000457

T45



142 8-9-10-11-12
13-14-15-16
17-18-19 mm

1,3 kg



T45	340,00	1	024240045
TV45	29,50	1	024000498

T46



142SN 8-9-10-11-12
13-14-15-16
17-18-19 mm

1,5 kg



T46	405,00	1	024240046
TV46	29,50	1	024000499

T48



○96BPC/SC9 1,5+10 mm
142C 8-9-10-11-12
13-14-15-16
17-18-19 mm

1,4 kg



T48	289,00	1	024240048
TV47	29,50	1	024000763

T50



○96T 2-2,5-3-3,5-4-4,5
5-6-7-8-10 mm

1,3 kg



T50	192,00	1	024240050
TV50	38,50	1	024000764

T52



○96T 2-2,5-3-4-5-6 mm

350 g



T52	94,00	1	024240052
TV52	29,50	1	024000765

T55



○97TTX T10-T15-T20
T25-T27-T30

330 g



T55	109,00	1	024240055
TV55	29,50	1	024000766

T59



111E 250 mm
920/40 ■ 1/2
951 2,5-3-4-5-6-8 mm
○953 4-5-6-8 mm
1370 300 - 500 g

4,7 kg



T59	486,00	1	024240059
TV60	58,00	1	024000420

T63



○952 7 - 8 - 10 - 12 - 13 - 14 - 17 - 19 mm

3,8 kg



T63	368,00	1	024240063
TV63	48,00	1	024000471

T64



- 952FTX E10-E12-E14
- 953TX T25 - T27 - T30 - T40 - T45

3,8 kg



T64	€ 450,00	1	024240064
TV63	€ 48,00	1	024000471

T65



- 953 3 - 3,5 - 4 - 5 - 6 - 7 - 8 - 10 mm

2,8 kg



T65	€ 351,00	1	024240065
TV63	€ 48,00	1	024000471

T68



- 951 2,5-3-4-5-6-8 mm

590 g



T68	€ 157,00	1	024240068
TV68	€ 29,50	1	024000470

T73



- 930 6x7 - 8x9 - 10x11 - 12x13 - 14x15 - 16x17 - 18x19 - 20x22 mm
- 940/1
- 940/2

1,3 kg



T73	€ 234,00	1	024240073
TV73	€ 29,50	1	024000418

T75



- 933 7-8-9-10-11-12-13 - 14-15-16-17-18-19 - 21-22-24 mm

4,2 kg



T75	€ 477,00	1	024240075
TV75	€ 58,00	1	024000422

T76



- 932 7-8-9-10-11-12-13 - 14-15-16-17-18-19 - 21-22-24 mm

4,2 kg



T76	€ 477,00	1	024240076
TV75	€ 58,00	1	024000422

T77



- 933 6-7-8-10-11-12-13 - 14-17-19 mm

1,4 kg



T77	€ 238,00	1	024240077
TV77	€ 29,50	1	024000474

T80



- 920A 10-11-12-13-14 - 15-16-17-18-19 - 20-21-22-23-24 - 26-27-30-32 mm
- 920ME 5-6-8-10-12 mm
- 920/21 125 mm
- 920/22 255 mm
- 920/25
- 920/42 305 mm
- 920/55

4,1 kg

12"



T80	€ 446,00	1	024240080
TV80	€ 38,50	1	024000403

T81



- 920B 10-11-12-13-14 - 15-16-17-18-19 - 20-21-22-23-24 - 26-27-30-32 mm
- 920ME 5-6-8-10-12 mm
- 920/21 125 mm
- 920/22 255 mm
- 920/25
- 920/42 305 mm
- 920/55

4,1 kg

12"



T81	€ 446,00	1	024240081
TV80	€ 38,50	1	024000403

T82



- 920A 10-11-12-13-14 - 15-16-17-18-19 - 20-21-22-23-24 - 26-27-30-32 mm
- 920ME 5-6-8-10-12 mm
- 920AN/125 125 mm
- 920AN/250 250 mm
- 920/25
- 920/42 305 mm
- 920/55

4,1 kg

12"



T82	€ 460,00	1	024240082
TV80	€ 38,50	1	024000403

T83



- 920A 10-11-12-13-14 - 15-16-17-18-19 - 20-21-22-23-24 - 26-27-30-32 mm
- 920/21 125 mm
- 920/22 255 mm
- 920/25
- 920/42 305 mm
- 920/55

3,6 kg

12"



T83	€ 345,00	1	024240083
TV83	€ 38,50	1	024000402



T85



- 861LP 0,5x3 - 0,6x4,5 - 0,8x5,5 - 1x5,5 - 1,2x6,5 - 1,2x8 - 1,6x8 mm
- 861PE 2 - 2,5 - 3 - 4 - 5 - 6 - 8 - 10 mm
- ⊕ 861PH PH0 - PH1 - PH2 - PH3
- ⊕ 861PZ PZ1 - PZ2 - PZ3
- ⊕ 861TX T6 - T7 - T8 - T9 - T10 - T15 - T20 - T25 - T27 - T30 - T40
- ⊕ 861RTX T9 - T10 - T15 - T20 - T25 - T27 - T30 - T40
- ⊕ 861TRW 1-2-3-4-5-6 mm
- ⊕ 861TQS 0 - 1 - 2 - 3 - 4 - 5 - 6 - 8 - 10 mm
- 861SP 4-6-8-10-12 mm
- 851SR 230 mm
- 900 4-4,5-5-5,5-6-7-8-9 - 10-11-12-13-14 mm
- 900/21 150 mm
- 900/25 41 mm
- 900BG/30 176 mm
- 900/42 115 mm
- ⊕ 900/55 125 mm
- 194 1/4x5/16

1,0 kg 14"

T85	378,00	€	1	024240085
TV85	38,50	€	1	024000747

T91



- 900 4-4,5-5-5,5-6 - 7-8-9-10-11 - 12-13-14 mm
- 900ME 2,5-3-4-5-6-8 mm
- 900/20 50 mm
- 900/21 150 mm
- 900/25 150 mm
- 900BG/30 176 mm
- 900/42 115 mm
- ⊕ 900/55 125 mm

560 g 14"

T91	242,00	€	1	024240091
TV90	29,50	€	1	024000447

T92



- 910A 6-7-8-9-10-11-12-13 - 14-15-16-17-18-19 - 20-21-22 mm
- 910/21 125 mm
- 910/22 250 mm
- 910/25 250 mm
- 910/42 210 mm
- ⊕ 910/55 125 mm

1,5 kg 38"

T92	273,00	€	1	024240092
TV92	29,50	€	1	024000458

T99



- 920INOX-A 10-12-13-14-15-16-17 - 18-19-21-22-24-27 - 30-32 mm
- ⊕ 920/55INOX



2,7 kg 12"

T99	1.290,00	€	1	024240099
TV99	29,50	€	1	024249908

T100



- 920A 10-12-13-14-15 - 16-17-18-19-21 - 22-24 mm
- 920/21 125 mm
- 920/25 125 mm
- 920/42 305 mm
- ⊕ 920/55 125 mm

2,1 kg 12"

T100	247,00	€	1	024240100
TV100	29,50	€	1	024000495

T101



- 920B 10-12-13-14-15 - 16-17-18-19-21 - 22-24 mm
- 920/21 125 mm
- 920/25 125 mm
- 920/42 305 mm
- ⊕ 920/55 125 mm

2,1 kg 12"

T101	247,00	€	1	024240101
TV100	29,50	€	1	024000495

T102



- 920AS 3/8-7/16-1/2 - 9/16-5/8-11/16 - 3/4-13/16-7/8 - 15/16-1-1.1/16
- 920/21 125 mm
- 920/25 125 mm
- 920/42 305 mm
- ⊕ 920/55 125 mm

2,1 kg 12"

T102	270,00	€	1	024240102
TV100	29,50	€	1	024000495

T103



- 900L 6-7-8-9-10-11-12 mm
- 920AL 13-14-16-17-18-19 - 21-22-24-27 mm

1,1 kg 14" 12"

T103	324,00	€	1	024240103
TV103	29,50	€	1	024000748

T105



- 928A 22-24-27-30-32-34 - 36-38-41-46-50 mm

4,9 kg 34"

T105	323,00	€	1	024240105
TV105	29,50	€	1	024000484

T106



- 928/21 200 mm
- 928/22 380 mm
- 928/42 450 mm
- 928/55 125 mm

4,5 kg 34"

T106	342,00	€	1	024240106
TV106	29,50	€	1	024000485

T111



- 720 10-13-15-17-18-19-21 - 22-24-27-30-32 mm
- 720LC 17-19-21 mm
- 720/21 125 mm

2,7 kg 12"

T111	278,00	€	1	024240111
TV111	29,50	€	1	024000476

T112

32



- 861TX ● 1/4-T6+T15
- 866TX ● 5/16-T20+T55
- 895/1 ○ 1/4x□1/4
- 895/6 ○ 5/16x□1/2
- 900FTX □ 1/4-E4+E10
- 920FTX □ 1/2-E12+E24
- 920TX □ 1/2-T55L-T60-T70L

1,3 kg

14" 12"



T112	€ 328,00	1	024240112
TV112	€ 29,50	1	024000480

T113

12



- 920PE 5L-6L-7L-8L-10L
- 920TX T40L-T45L
T55L-T70L
- 920XZN M6L-M8L-M12L

1,5 kg

12"



T113	€ 288,00	1	024240113
TV113	€ 29,50	1	024000489

T122

1



666/20 40 - 200 Nm

1,2 kg

12"



T122	€ 319,00	1	024240122
TV122	€ 29,50	1	024000768

T123

3



- 1082G 160 mm
- 1150G 180 mm
- 1166G 160 mm

550 g



T123	€ 88,00	1	024240123
TV135	€ 29,50	1	024000762

T124

3



- 1082GBM 160 mm
- 1150GBM 180 mm
- 1166GBM 160 mm

640 g



T124	€ 112,00	1	024240124
TV135	€ 29,50	1	024000762

T135

3



- 1082MQ 160 mm
- 1150MQ 180 mm
- 1166MQ 160 mm

1000 V

750 g



T135	€ 186,00	1	024240135
TV135	€ 29,50	1	024000762

T136

2



- 1048MQ 250 mm
- 1777MQ/U

1000 V

700 g



T136	€ 133,00	1	024240136
TV136	€ 29,50	1	024000438

T137

3



- 1084BM 160 mm
- 1150BM 180 mm
- 1166BM 160 mm

750 g



T137	€ 126,00	1	024240137
TV130	€ 29,50	1	024000451

T138

3



- 1084 160 mm
- 1150 180 mm
- 1166 160 mm

650 g



T138	€ 104,00	1	024240138
TV130	€ 29,50	1	024000451

T140

8



- 1032 140x0,9 - 180 mm
- 1034 170 mm
- 1036 140x1,3 - 175 mm
- 1038 175 mm
- 1084 160 mm
- 1128BM

1,1 kg



T140	€ 255,00	1	024240140
TV140	€ 38,50	1	024000405

T144

4



- 1048N 250 mm
- 1052 240 mm
- 1112 250 mm
- 1150 180 mm

1,8 kg



T144	€ 147,00	1	024240144
TV143	€ 38,50	1	024000409

T145

4



- 1032 180 mm
- 1034 170 mm
- 1036 175 mm
- 1038 175 mm

640 g



T145	€ 141,00	1	024240145
TV145	€ 29,50	1	024000448

T146



- 1032 140x0,9 mm
- 1032 225 mm
- 1036 140x1,3 mm
- 1036 225 mm

700 g



T146	148,00	1	024240146
TV146	29,50	1	024000449

T151



- 1047 240 mm
- 1057A 240 mm

1,3 kg



T151	127,00	1	024240151
TV150	29,50	1	024000462

T153



- 1048N 250 mm
- 1052 240 mm

1,1 kg



T153	77,00	1	024240153
TV150	29,50	1	024000462

T156



- ◁ 1082 160 mm
- ▬ 1150 180 mm
- 1048N 250 mm

1 kg



T156	102,00	1	024240156
TV148	29,50	1	024000500

T157



- ◁ 1082BM 160 mm
- ▬ 1150BM 180 mm
- 1048BM 250 mm

1,1 kg



T157	140,00	1	024240157
TV148	29,50	1	024000500

T160



- 1290 3x75
- 3x100
- 4x100
- 4x150
- 5,5x100
- 5,5x150
- 6,5x150
- 8x150
- 10x200 mm
- 1290N 4x30
- 6,5x30 mm

1,3 kg



T160	153,00	1	024240160
TV160	38,50	1	024000706

T161



- 1292 PH0x60
- PH0x100
- PH1x80
- PH1x120
- PH2x100
- PH2x150
- PH3x150 mm
- 1292N PH1x30
- PH2x30 mm

1 kg



T161	121,00	1	024240161
TV161	38,50	1	024000707

T164



- 952 8-10-13-17-19 mm
- 959 16 mm (5/8")-20,8 mm (13/16")
- 1260 3x75-4x100-5,5x100-6,5x150-10x200 mm
- 1262 PH0x60-PH1x80-PH2x100-PH3x150 mm

5 kg



T164	520,00	1	024240164
TV61	58,00	1	024000721

T167



- 1260 3x75
- 3x100
- 4x100
- 4x150
- 5,5x100
- 5,5x150
- 6,5x150
- 8x150
- 10x200 mm
- 1260N 4x30
- 6,5x30 mm

1,3 kg



T167	124,00	1	024240167
TV160	38,50	1	024000706

T168



- 1262 PH0x60
- PH0x100
- PH1x80
- PH1x120
- PH2x100
- PH2x150
- PH3x150 mm
- 1262N PH1x30
- PH2x30 mm

1 kg



T168	98,50	1	024240168
TV161	38,50	1	024000707

T170



- 1290 2,5x50
- 3x75
- 3,5x100
- 4x125
- 5,5x100
- 5,5x150
- 6,5x150 mm

450 g



T170	83,50	1	024240170
TV170	29,50	1	024000741

T171



- 1290 8x150
- 8x200
- 10x200 mm
- 1290N 4x30
- 6,5x30 mm

750 g



T171	92,00	1	024240171
TV171	29,50	1	024000742

T172**Betamax**

- 1292 PH0x60
PH0x100
PH1x80
PH1x120
PH2x100
PH2x150 mm

i 450 g



T172	€ 76,00	1	024240172
TV172	€ 29,50	1	024000743

T173**Betamax**

- 1292 PH3x150
PH4x200 mm
- 1292N PH1x30
PH2x30 mm

i 560 g



T173	€ 74,50	1	024240173
TV173	€ 29,50	1	024000744

T175**Betamax**

- ⊖ 1297TX T6-T7-T8-T9
T10-T15-T20

i 410 g



T175	€ 119,00	1	024240175
TV175	€ 29,50	1	024000760

T176**Betamax**

- ⊖ 1297TX T25-T27-T30
T40-T45

i 640 g



T176	€ 110,00	1	024240176
TV176	€ 29,50	1	024000761

T177**Betamax**

- ⊖ 1298RTX T9-T10-T15
T20-T25-T27
T30-T40

i 680 g



T177	€ 166,00	1	024240177
TV177	€ 29,50	1	024000759

T180**Betamax**

- ⊖ 1290 3x75
4x100
5,5x150
6,5x150 mm
- 1292 PH0x60
PH1x80
PH2x100 mm

i 480 g



T180	€ 86,50	1	024240180
TV180	€ 29,50	1	024000701

T183**Betamax**

- 1292L PH1x400-PH2x400 mm
- ⊖ 1294L 3x300-4x400-5x400 mm

i 580 g



T183	€ 118,00	1	024240183
TV183	€ 29,50	1	024000497

T198**Betamax**

- ⊖ 1260 3x75
4x100
5,5x150
6,5x150 mm
- 1269PZ PZ0 - PZ1 - PZ2

i 490 g



T198	€ 74,00	1	024240198
TV180	€ 29,50	1	024000701

T199

- ⊖ 1260 2,5x50
3x75
3,5x100
4x125
5,5x100
5,5x150
6,5x150 mm

i 490 g



T199	€ 66,50	1	024240199
TV170	€ 29,50	1	024000741

T201

- ⊖ 1260 8x200
10x150
10x200 mm
- ⊖ 1260N 4x30
6,5x30 mm

i 680 g



T201	€ 72,00	1	024240201
TV171	€ 29,50	1	024000742

T202

- 1262 PH0x60
PH0x100
PH1x80
PH1x120
PH2x100
PH2x150 mm

i 490 g



T202	€ 61,00	1	024240202
TV172	€ 29,50	1	024000743

T204

- 1262 PH3x150
PH4x200 mm
- 1262N PH1x30
PH2x30 mm

i 610 g



T204	€ 60,00	1	024240204
TV173	€ 29,50	1	024000744

T205



1267TX T6-T7-T8-T9
T10-T15-T20

460 g



T205	86,50	1	024240205
TV175	29,50	1	024000760

T206



1267TX T25-T27-T30
T40-T45

710 g



T206	89,50	1	024240206
TV176	29,50	1	024000761

T207



1268RTX T9-T10-T15
T20-T25-T27-T30

760 g



T207	107,00	1	024240207
TV207	29,50	1	024000758

T208



1260 3x75
4x100
5,5x150
6,5x150 mm
1262 PH0x60
PH1x80
PH2x100 mm

530 g



T208	70,00	1	024240208
TV180	29,50	1	024000701

T209



1262L PH1x400-PH2x400 mm
1264L 3x300 - 4x400 - 5x400 mm

580 g



T209	87,00	1	024240209
TV183	29,50	1	024000497

T211



1201E 2,5x50
3x75
3,5x100
4x125
5,5x100
5,5x150
6,5x150 mm

490 g



T211	47,00	1	024240211
TV170	29,50	1	024000741

T213



1202E PH0x60
PH1x80
PH1x120
PH2x100
PH2x150
PH3x150 mm

490 g



T213	51,00	1	024240213
TV212	29,50	1	024000440

T216



1207E/TX T6-T7-T8-T9
T10-T15-T20

410 g



T216	65,00	1	024240216
TV175	29,50	1	024000760

T221



1201E 3x75
4x100
5,5x150
6,5x150 mm
1202E PH0x60
PH1x80
PH2x100 mm

530 g



T221	49,50	1	024240221
TV180	29,50	1	024000701

T226



1274MQ 3x100
4x100
5,5x125
6,5x150 mm
1272MQ PH0x60
PH1x80
PH2x100 mm

1000 V

460 g



T226	108,00	1	024240226
TV180	29,50	1	024000701

T227



944BX 5-6-7-8-10-13 mm

490 g



T227	151,00	1	024240227
TV227	29,50	1	024000705

T228



1290INOX 3x75 - 4x100 -
5,5x150 - 6,5x150 mm
1292INOX PH0x60
- PH1x80 - PH2x100
mm

480 g



T228	97,00	1	024240228
TV180	29,50	1	024000701

T231



- 1370 400 g
- 1390 Ø 35 mm
- ▲ 1719BMA/T 200 mm
- 1719BMA/P 200 mm
- ▷ 1719BMA/M 200 mm

1,7 kg



T231	€ 133,00	1	024240231
TV230	€ 38,50	1	024000411

T233



- 35 100-200 mm
- 1370F 32 mm
- 1390 Ø 35 mm

1,3 kg



T233	€ 121,00	1	024240233
TV232	€ 29,50	1	024000452

T234



- 35 100-200 mm
- 1370 300 g
- 1390 Ø 35 mm

1,3 kg



T234	€ 109,00	1	024240234
TV232	€ 29,50	1	024000452

T236



- 1719BMA/Q 200 mm
- ▲ 1719BMA/T 200 mm
- 1719BMA/P 200 mm
- ▷ 1719BMA/M 200 mm
- 1719BMA/R 200 mm

870 g



T236	€ 108,00	1	024240236
TV235	€ 29,50	1	024000453

T239



- 31BM Ø 2-3-4-5-6-8 mm
- 32 Ø 4 mm

850 g



T239	€ 143,00	1	024240239
TV239	€ 29,50	1	024000439

T241



- 1500N/1
- 1500N/3
- 1516/1

4,2 kg



T241	€ 333,00	1	024240241
TV241	€ 38,50	1	024000414

T259



- 96BP 2,5-3-4-5
6-8-10 mm
- 96N 12 mm
- 860MIX/A31
-
- +
- +
- +
- 895/1

950 g



T259	€ 167,00	1	024240259
TV263	€ 29,50	1	024000492

T264



- 1491 Ø 65+110 mm
- 1494 ■ 10 mm
- 1494E ○ 8 - 9 - 10 - 11 - 12 - 14 - 17 mm
- 1494Q ○ 8-9,5-12-13 mm
- △ 1494T △ 9,5
- 1494XZN ○ 16
- 1496C ■ 8x ■ 10 mm

2,1 kg



T264	€ 250,00	1	024240264
TV264	€ 29,50	1	024000466

T270



- 430 M3 - 4 - 5 - 6 - 7 - 8 - 9
10 - 12 - 14 - 16 - 18 - 20
- 433 M6x0,75 - M8x1 - M10x1,25
M12x1,5 - M14x1,5
M16x1,5 - M18x1,5
- 440 M3 - 4 - 5 - 6 - 7 - 8 - 9
- 440A M10 - 12 - 14 - 16 - 18 - 20
- 441 M6x0,75 - M8x1,0
- 441A M10x1,25 - M12x1,5
M14x1,5 - M16x1,5
M18x1,5

4,3 kg



T270	€ 580,00	1	024240270
TV270	€ 38,50	1	024000481

T273



- 435/1,5 M3+M12
- 435/3 M5+M21
- 436/1 □ 2,0+5,0 mm
(M3+M8)
- 436/2 □ 4,6+8 mm
(M5+M12)
- 444/1 Ø 25,4 mm
- 444/2 Ø 38,1 mm
- 1707 W 62+4x1"

2,1 kg



T273	€ 262,00	1	024240273
TV272	€ 38,50	1	024000482

T281



- 1741B 250 mm
- 1741RV2,9K 2,9x6 mm (100)
- 1741RV3,2K 3,2x8 mm (100)
- 1741RV3,8K 3,8x10 mm (100)
- 1741RV4K 4x12 mm (100)

1,4 kg



T281	€ 82,00	1	024240281
TV280	€ 29,50	1	024000478

T279



1112	250 mm
1128BM	
1726	400 mm
1728BM	(x5)
1751N	200 cc

1,5 kg



T279	142,00	€	1	024240279
TV285	48,00	€	1	024000487

T284



1128BMX	
1130BMX	
■ 1719BMA...Q	200 mm
▲ 1719BMA...T	200 mm
■ 1719BMA...P	200 mm
▶ 1719BMA...M	200 mm
● 1719BMA...R	200 mm
1726BM	400 mm
1728BM	
1771BM	170 mm
1778V18	185 mm

3,3 kg



T284	282,00	€	1	024240284
TV286	58,00	€	1	024249904

T291



1479RB/1
1479RB/2
1479RB/3

600 g



T291	113,00	€	1	024240291
TV291	29,50	€	1	024000472

T294



1692 5 m
1725CR
1771RL
1771

590 g



T294	78,00	€	1	024240294
TV294	29,50	€	1	024000491

T297



1651DGTB
1682
1691BM

490 g



T297	157,00	€	1	024240297
TV296	29,50	€	1	024000749



VP1 - VP2

tabuleiros para peças de pequenas dimensões em material plástico para todos os modelos de caixas com gavetas: RSC22, RSC23, RSC23C



	H mm	€	1	088880351
VP1	50	16,70	1	088880351
VP2	35	16,70	1	088880352

VP3 - VP4

tabuleiros para peças de pequenas dimensões em material plástico para todos os modelos de carros com gavetas e para os carros

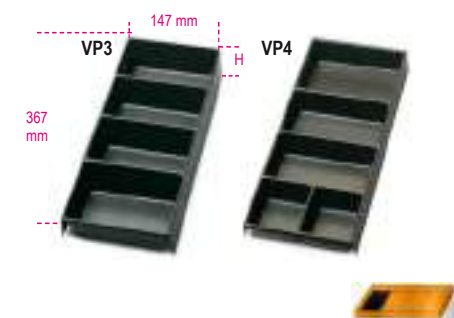

	H mm	€	1	088880353
VP3	50	17,60	1	088880353
VP4	35	17,60	1	088880354

VP5

tabuleiros



	€	1	088880355
VP5	19,90	1	088880355

VP6

tabuleiros



	€	1	088880359
VP6	20,20	1	088880359

VP-3SC

tabuleiros em plástico para ferramentas, para carro C38 +C04TSS-7

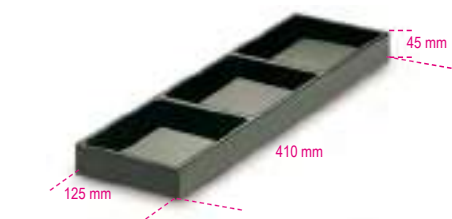

	H mm	€	1	088880356
VP-3SC	45	21,20	1	088880356

VP-LS

tabuleiros em plástico para ferramentas, para carro C38 +C04TSS-7



	H mm	€	1	088880357
VP-LS	45	14,40	1	088880357

VP-LD

tabuleiros em plástico para ferramentas, para carro C38



	H mm	€	1	088880358
VP-LD	45	13,90	1	088880358

8889P1

divisórias paralelas para ref. RSC22, RSC23, RSC23C e C27S
gaveta 588x277 mm

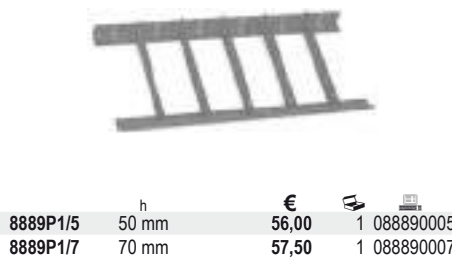

	h mm	€	1	088890005
8889P1/5	50	56,00	1	088890005
8889P1/7	70	57,50	1	088890007

8889C1

divisórias em cruz para ref. RSC22, RSC23, RSC23C e C27S
para gaveta 588x277 mm

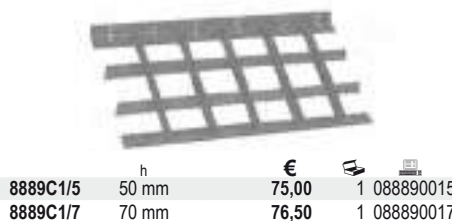

	h mm	€	1	088890015
8889C1/5	50	75,00	1	088890015
8889C1/7	70	76,50	1	088890017

8889P2

divisórias paralelas para gaveta standard 588x367 mm

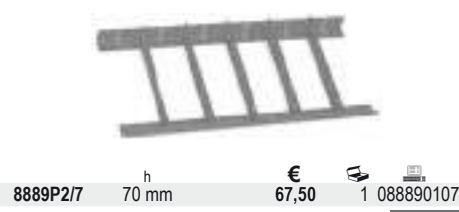

	h mm	€	1	088890107
8889P2/7	70	67,50	1	088890107

8889C2

divisórias em cruz para gaveta standard 588x367 mm

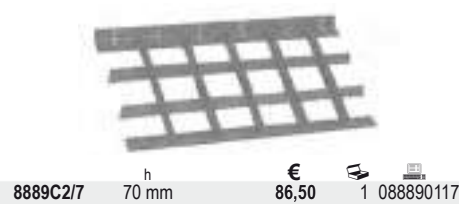

	h mm	€	1	088890117
8889C2/7	70	86,50	1	088890117

8889P3

divisórias paralelas para ref. RSC24AXL

para gaveta 882x367 mm

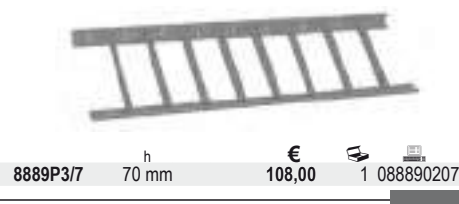

	h mm	€	1	088890207
8889P3/7	70	108,00	1	088890207

8889C3

divisórias em cruz para RSC24AXL

para gaveta 882x367 mm

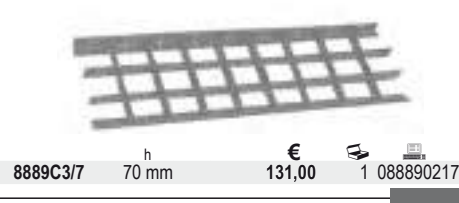

	h mm	€	1	088890217
8889C3/7	70	131,00	1	088890217

8889P4

divisórias paralelas para ref. C41

para gaveta 418x205 mm



	h mm	€	1	088890307
8889P4/7	70	45,50	1	088890307

8889I4

divisórias em cruz para ref. y C41

para gaveta 418x205 mm

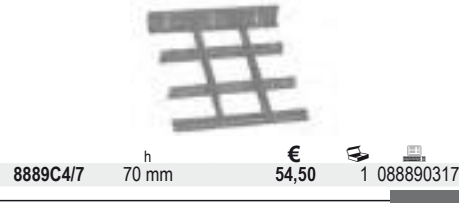

	h mm	€	1	088890317
8889C4/7	70	54,50	1	088890317

8889PS

divisórias paralelas para ref. C38 - C45PRO
M4/M5/M7/M8

gaveta do lado esquerdo 570x410 mm



8889PS/7 h 70 mm € 80,00 1 088890407

8889CS

divisórias em cruz para ref. C38 - C45PRO M4/
M5/M7/M8

gaveta do lado esquerdo 570x410 mm



8889CS/7 h 70 mm € 97,50 1 088890417

8889PD

divisórias paralelas para ref. C38

gaveta do lado direito 313x410 mm



8889PD/7 h 70 mm € 42,50 1 088890427

8889CD

divisórias em cruz para ref. C38

gaveta do lado direito 313x410 mm



8889CD/7 h 70 mm € 58,50 1 088890437

8889C6

divisórias em cruz para ref. C35

para gaveta 600x447 mm



8889C6/7,5 h 75 mm € 41,50 1 088890475
8889C6/10 h 100 mm € 41,00 1 088890480
8889C6/15 h 150 mm € 51,00 1 088890485
8889C6/20 h 200 mm € 79,50 1 088890490

SB

guia porta-chaves



L mm € 10 088880201
SB1 210 4,25
SB2 280 4,70
SB3 360 4,95 10 088880203

PM 1/2-Q5

calha magnética para chaves de caixa



PM 1/2-Q5 € 52,00 1 088880233

MB

molhas para guia SB



MB0 1/4 € 1,26 50 088880210
MB1 3/8 € 1,26 50 088880211
MB2 1/2 € 1,26 50 088880212

KIT/GPS



KIT/GPS-40 mm € 2,44 50 088880119
KIT/GPS-90 mm € 3,55 50 088880117

VE1



VE1 € 0,86 20 088880120

GM

ganchos de mola com parafusos de expansão VE1



Ø mm € 5 088880250
6,5 7,80
9,5 8,20 5 088880251
13 8,20 5 088880252
16 9,60 5 088880253
19 10,00 5 088880254
25 9,50 5 088880255

S55/8

suporte para 8 chaves de bocas, em chapa
metálica

• fornecido com 3 parafusos de expansão VE1

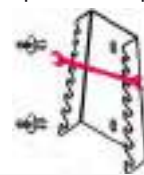

S55/8 € 27,00 1 088880420
55/S8
55AS/8
55MP/S8

S55/12

suporte para 12 chaves de bocas, em chapa
metálica

• fornecido com 3 parafusos de expansão VE1

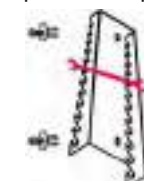

S55/12 € 32,50 1 088880421
55/S12
55/S12X
55AS/12
55MP/S12

ST2P

suporte para alicates, em chapa metálica

• Fornecido com 3 parafusos de expansão VE1

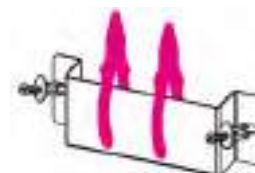

ST2P € 29,50 1 088880422

TSPP

suporte para ferramentas, em plástico

• Fornecido com 3 parafusos de expansão VE1

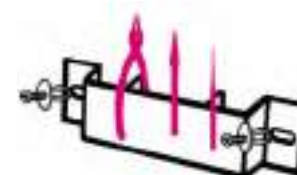

TSPP € 6,60 1 088880402

S952/10

suporte para 10 chaves em T, em chapa
metálica

• Fornecido com 3 parafusos de expansão VE1



S952/10 € 35,00 1 088880423

S1719BM

suporte para 5 limas, em chapa metálica

• fornecido com 3 parafusos de expansão VE1



S1719BM	€	1	088880404
1719BMA: Q-T-P-M-R	20,20		
1719BMD: Q-T-P-M-R			
1719BMX: Q-T-P-M-R			

SGN

suporte para 2 mini chaves de fendas, em chapa metálica

• fornecido com 3 parafusos de expansão VE1



SGN	€	1	088880405
1290N-1292N-1299N/PZ	10,20		
1260N-1262N-1269N/PZ			
1201EN-1202EN-1209EN/PZ			

CB/2

tabuleiro rígido para chaves de caixa 1/2" e acessórios, vazio

• apenas para item C54S

12"



CB/2	€	1	088880411
920A/920B	31,00		
10÷24+26-27			
28-30-32 mm			
920/21-920/22-920/25-			
920/42-920/55			

S42/17

suporte para 17 chaves mistas boca/luneta, em chapa metálica

• Fornecido com 3 parafusos de expansão VE1



S42/17	€	1	088880428
42/S17	34,50		
42MP/S17			
42/S17X			
42AS/17			
142/S17			

S951/6

suporte para 6 chaves em T com macho sextavado, em chapa metálica

• fornecido com 3 parafusos de expansão VE1



S951/6	€	1	088880429
951/S6	22,80		
951AS/S6X			
951TX/S6			

SPG11 - S1203/8

suporte para chaves de fendas, em chapa metálica

• fornecido com 3 parafusos de expansão VE1

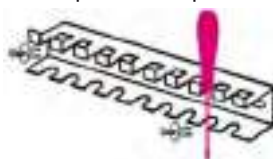

SPG11	€	1	088880910
n.8 Ø = 7 mm	23,70		
n.2 Ø = 10 mm			
n.1 Ø = 12 mm			
S1203/8	€	1	088880430
1203E/S8	25,00		
1263/D8			
1293/S8			

S96T/8

suporte para 8 chaves macho sextavadas, com punho de binário elevado, em chapa metálica

• Fornecido com 3 parafusos de expansão VE1



S96T/8	€	1	088880431
96T/AS8	25,00		
96T/S8			
97TTX/S8			

96T/SPV

suporte para 11 chaves macho sextavadas, com punho de binário elevado, em chapa metálica

• fornecido com 3 parafusos de expansão VE1

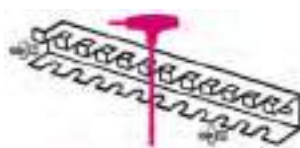

96T/SPV	€	1	000960958
96T/S11	49,00		
97TTX/S11			





Beta CHEMICALS

Apertar um parafuso nem sempre é suficiente para garantir uma fixação segura. Limpeza, lubrificação e bloqueio também são necessários.

A linha inclui produtos anaeróbicos, adesivos de cianoacrilato e sprays para manutenção, limpeza e lubrificação de componentes mecânicos.

Produtos Anaeróbicos

Os produtos anaeróbicos permitem o preenchimento completo de pequenas irregularidades existentes no metal, para que a tensão mecânica possa ser distribuída por toda a superfície. Estes endurecem na ausência total de oxigénio e vedam completamente juntas ou roscas de água, gás, óleo, combustível e fluidos industriais.

Estão disponíveis em três diferentes forças - alta (H), média (M) e baixa (L) - e em diferentes packs, para satisfazer diferentes necessidades.

Vedante silicone

Os vedantes de silicone permitem uma selagem elástica permanente, evitando assim a entrada de pequenas substâncias na junta (dejetos, poeiras...) e substituem as juntas pré-formadas. Pela sua capacidade elástica, podem absorver o movimento, sem serem afetados pela expansão ou quebra interior. Os vedantes de silicone polimerizam ao reagir com a humidade atmosférica e formam juntas elásticas e duráveis.

O produto é fornecido num prático dispensador (embalagem sob pressão), o que simplifica o trabalho. Também pode ser utilizado com uma mão, garantindo uma aplicação precisa e uniforme

Cola Instantânea

Adesivo à base de cianoacrilato de etilo para juntas estruturais em vários materiais.

Aerosóis

Ampla gama de produtos em spray, para utilizações tão diversas como lubrificar, olear, desbloquear, galvanizar e limpar.

Líquidos

Desenvolvidos para remoção de incrustações e ferrugem de componentes mecânicos e objetos em metal. Ideais para utilização com os tanques de limpeza ultrassónicos 1895.



ATENÇÃO

Países onde os produtos químicos Beta podem ser distribuídos: Áustria, Andorra, Bélgica, República Checa, República Dominicana, França, Hungria, Itália, Holanda, Nova Caledónia, República Popular da China, Polónia, Portugal, Principado do Mónaco, República da Irlanda, Reunião, San Marino, Eslováquia, Eslovênia, Espanha, Suíça, Emirados Árabes Unidos, Reino Unido.

9803H

bloqueante - força elevada

Apropriado para o bloqueio permanente de partes que não devem ser desmontadas.
Para a aplicação em superfícies metálicas passivadas como latão, alumínio e aço inox.
Não permite a desmontagem com ferramentas manuais.



Temperatura de emprego (°C)	-50/+150
Folga diametral (mm)	0,25
Velocidade de reação	10/15
bloqueio à mão (minutos)	
Endurecimento funcional (horas)	3-6
Viscosidade (mPa.s) 25 °C	800/1200
Binário de desparafusamento INICIAL (ISO-10964)	35-45 Nm
Binário de desaperto	30-40 Nm
RESÍDUO (ISO-10964)	

ml	€	🛠️	🏠
20 frasco	13,00	12	098030002
50 frasco	19,80	4	098030005
250 frasco	50,50	4	098030025
20 frasco		12	098032002
50 frasco		4	098032005
250 frasco		4	098032025

9802M

bloqueante - força média

Apropriado para fixar e bloquear partes submetidas a manutenção e desmontagens periódicas.
Permite a desmontagem com o uso de ferramentas manuais.



Temperatura de emprego (°C)	-50/+150
Folga diametral (mm)	0,15
Velocidade de reação	10/15
bloqueio à mão (minutos)	
Endurecimento funcional (horas)	3-6
Viscosidade (mPa.s) 25 °C	500/800
Binário de desparafusamento INICIAL (ISO-10964)	22-30 Nm
Binário de desaperto	20-25 Nm
RESÍDUO (ISO-10964)	

ml	€	🛠️	🏠
20 frasco	13,00	12	098020002
50 frasco	19,80	4	098020005
250 frasco	50,50	4	098020025
20 frasco		12	098022002
50 frasco		4	098022005
250 frasco		4	098022025

9801L

bloqueante - força reduzida

Apropriado para bloquear partes em ligas leves que poderão danificar-se durante a desmontagem ou para parafusos de regulação.
Permite uma fácil desmontagem das partes juntadas.



Temperatura de emprego (°C)	-50/+150
Folga diametral (mm)	0,10
Velocidade de reação	10/15
bloqueio à mão (minutos)	
Endurecimento funcional (horas)	3-6
Viscosidade (mPa.s) 25 °C	500/800
Binário de desparafusamento INICIAL (ISO-10964)	6-10 Nm
Binário de desaperto	4-8 Nm
RESÍDUO (ISO-10964)	

ml	€	🛠️	🏠
20 frasco	13,00	12	098010002
50 frasco	19,80	4	098010005
250 frasco	50,50	4	098010025
20 frasco		12	098012002
50 frasco		4	098012005
250 frasco		4	098012025

9813H

vedante de rosca - força elevada

Apropriado para a vedação permanente de conexões com rosca que não devem ser desmontadas.
Para a aplicação sobre superfícies metálicas passivadas como latão, alumínio e aço inox.
Não permite a desmontagem com ferramentas manuais.



Temperatura (°C)	-50/+200
Folga diametral (mm)	0,15
Velocidade de reação	10/15
bloqueio à mão (minutos)	
Endurecimento funcional (horas)	3-6
Viscosidade (mPa.s) 25 °C	40.000/80.000
Binário de desparafusamento INICIAL (ISO-10964)	35-45 Nm
Binário de desaperto	25-35 Nm
RESÍDUO (ISO-10964)	

ml	€	🛠️	🏠
20 frasco	11,60	12	098130002
50 frasco de fole	20,30	6	098130305
50 tubo	19,00	4	098130505
250 tubo	47,00	4	098130525
20 frasco		12	098132002
50 frasco de fole		6	098132305
50 tubo		4	098132505
250 tubo		4	098132525

9812M

vedante de rosca - força média

Apropriado para vedar conexões com rosca submetidas a manutenção periódica.
Permite a desmontagem com o uso de ferramentas manuais.



Temperatura (°C)	-50/+150
Folga diametral (mm)	0,35
Velocidade de reação	12/18
bloqueio à mão (minutos)	
Endurecimento funcional (horas)	3-6
Viscosidade (mPa.s) 25 °C	20.000/40.000
Binário de desparafusamento INICIAL (ISO-10964)	27-35 Nm
Binário de desaperto	20-30 Nm
RESÍDUO (ISO-10964)	

ml	€	🛠️	🏠
20 frasco	11,60	12	098120002
50 frasco de fole	20,30	6	098120305
50 tubo	19,00	4	098120505
250 tubo	47,00	4	098120525
20 frasco		12	098122002
50 frasco de fole		6	098122305
50 tubo		4	098122505
250 tubo		4	098122525

9811L

vedante de rosca - força reduzida

Apropriado para vedar conexões pequenas ou de passo fino.
Permite uma fácil desmontagem das partes juntadas.



Temperatura (°C)	-50/+150
Folga diametral (mm)	0,20
Velocidade de reação	10/15
bloqueio à mão (minutos)	
Endurecimento funcional (horas)	3-6
Viscosidade (mPa.s) 25 °C	10.000/20.000
Binário de desparafusamento INICIAL (ISO-10964)	6-10 Nm
Binário de desaperto	4-8 Nm
RESÍDUO (ISO-10964)	

ml	€	🛠️	🏠
20 frasco	11,60	12	098110002
50 frasco de fole	20,30	6	098110305
50 tubo	19,00	4	098110505
250 tubo	47,00	4	098110525
20 frasco		12	098112002
50 frasco de fole		6	098112305
50 tubo		4	098112505
250 tubo		4	098112525

9823H

bloqueante líquido - força elevada

Apropriado para vedar superfícies de forma permanente.
Apropriado também para recompor alojamentos de rolamento ou partes desgastadas.
Não permite a desmontagem com ferramentas manuais.



Temperatura (°C)	-50/+150
Folga diametral (mm)	0,35
Velocidade de reação	10/16
bloqueio à mão (minutos)	
Endurecimento funcional (horas)	3-6
Viscosidade (mPa.s) 25 °C	100.000/200.000
Binário de desparafusamento INICIAL (ISO-10964)	35-45 Nm
Binário de desaperto	20-30 Nm
RESÍDUO (ISO-10964)	

ml	€	🔧	📦
20 frasco	11,60	12	098230002
50 frasco de fole	20,30	6	098230305
50 tubo	19,00	4	098230505
250 tubo	47,00	4	098230525
20 frasco		12	098232002
50 frasco de fole		6	098232305
50 tubo		4	098232505
250 tubo		4	098232525

9822M

bloqueante líquido - força média

Apropriado para vedar superfícies de partes submetidas a manutenção periódica.
Permite a desmontagem com o uso de ferramentas manuais.



Temperatura (°C)	-50/+150
Folga diametral (mm)	0,35
Velocidade de reação	10/15
bloqueio à mão (minutos)	
Endurecimento funcional (horas)	3-6
Viscosidade (mPa.s) 25 °C	40.000/70.000
Binário de desparafusamento INICIAL (ISO-10964)	25-35 Nm
Binário de desaperto	20-30 Nm
RESÍDUO (ISO-10964)	

ml	€	🔧	📦
20 frasco	11,60	12	098220002
50 frasco de fole	20,30	6	098220305
50 tubo	19,00	4	098220505
250 tubo	47,00	4	098220525
20 frasco		12	098222002
50 frasco de fole		6	098222305
50 tubo		4	098222505
250 tubo		4	098222525

9821L

bloqueante líquido - força reduzida

Apropriado para vedar superfícies de partes submetidas a manutenção frequente.
Tolera a ligeira contaminação de óleos.
Protege as roscas contra corrosão e grimpagens por corrosão.
Permite uma desmontagem fácil das partes montadas.



Temperatura (°C)	-50/+150
Folga diametral (mm)	0,35
Velocidade de reação	20/30
bloqueio à mão (minutos)	
Endurecimento funcional (horas)	3-6
Viscosidade (mPa.s) 25 °C	60.000/90.000
Binário de desparafusamento INICIAL (ISO-10964)	7-11 Nm
Binário de desaperto	4-9 Nm
RESÍDUO (ISO-10964)	

ml	€	🔧	📦
20 frasco	11,60	12	098210002
50 frasco de fole	20,30	6	098210305
50 tubo	19,00	4	098210505
250 tubo	47,00	4	098210525
20 frasco		12	098212002
50 frasco de fole		6	098212305
50 tubo		4	098212505
250 tubo		4	098212525

9833H

bloqueante- força elevada

Apropriado para a fixação de partes que não devem ser desmontadas.
Apropriado para fixar dispositivos já instalados e cuja desmontagem é difícil.
Não permite a desmontagem com ferramentas manuais.



Temperatura (°C)	-50/+180
Folga diametral (mm)	0,15
Velocidade de reação	10/15
bloqueio à mão (minutos)	
Endurecimento funcional (horas)	3-6
Viscosidade (mPa.s) 25 °C	400/700
Binário de desparafusamento INICIAL (ISO-10964)	35-45 Nm
Binário de desaperto	30-40 Nm
RESÍDUO (ISO-10964)	

ml	€	🔧	📦
20 frasco	12,30	12	098330002
50 frasco	19,00	4	098330005
250 frasco	48,50	4	098330025
20 frasco		12	098332002
50 frasco		4	098332005
250 frasco		4	098332025

9832M

bloqueante- força média

Apropriado para a fixação de partes submetidas a manutenção periódica.
Permite a desmontagem com o uso de ferramentas manuais.



Temperatura (°C)	-50/+180
Folga diametral (mm)	0,25
Velocidade de reação	12/20
bloqueio à mão (minutos)	
Endurecimento funcional (horas)	3-6
Viscosidade (mPa.s) 25 °C	2000/4000
Binário de desparafusamento INICIAL (ISO-10964)	25-35 Nm
Binário de desaperto	18-28 Nm
RESÍDUO (ISO-10964)	

ml	€	🔧	📦
20 frasco	12,30	12	098320002
50 frasco	19,00	4	098320005
250 frasco	48,50	4	098320025
20 frasco		12	098322002
50 frasco		4	098322005
250 frasco		4	098322025

9831L

bloqueante- força reduzida

Apropriado para a fixação de partes submetidas a manutenção frequente e de pequenas dimensões.
Permite uma desmontagem fácil das partes montadas.



Temperatura (°C)	-50/+150
Folga diametral (mm)	0,10
Velocidade de reação	10/15
bloqueio à mão (minutos)	
Endurecimento funcional (horas)	3-6
Viscosidade (mPa.s) 25 °C	500/800
Binário de desparafusamento INICIAL (ISO-10964)	6-10 Nm
Binário de desaperto	4-8 Nm
RESÍDUO (ISO-10964)	

ml	€	🔧	📦
20 frasco	12,30	12	098310002
50 frasco	19,00	4	098310005
250 frasco	48,50	4	098310025
20 frasco		12	098312002
50 frasco		4	098312005
250 frasco		4	098312025



9841N

selante silicónico de reticulação acética cor preta, resistente a temperaturas elevadas, com prático dispensador pressurizado

Suporta temperaturas até 240 °C
Permite selagem elástica permanente. Substitui juntas pré-formadas.
O dispensador permite uma distribuição fácil, precisa e uniforme do produto.
Polimeriza reagindo com a humidade atmosférica e forma uma junta elástica e durável.
Ideal para reservatórios de óleo, bombas de óleo, carcaças, caixas de engrenagens, peças de motor que não estão sujeitas a alta pressão e aplicações que requerem resistência a altas temperaturas. Adere a substratos não porosos, incluindo vidro, madeira revestida, cerâmica e esmalte. Não é adequado para PE, PP, PC, PMMA, PTFE, plásticos macios, neoprene e substratos betuminosos.
Não pode ser pintado.



ml	€	🛒	📄
200	30,50	12	098410120
200		12	098412120

9841R

selante silicónico de reticulação acética cor vermelha, resistente a temperaturas elevadas, com prático dispensador pressurizado

Suporta temperaturas até 300 °C
Permite selagem elástica permanente. Substitui juntas pré-formadas.
O dispensador permite uma distribuição fácil, precisa e uniforme do produto.
Polimeriza reagindo com a humidade atmosférica e forma uma junta elástica e durável.
Ideal para portas de fornos e fornalhas, placas, sistemas de aquecimento, tomadas, termostatos, bombas, tubos de aquecimento, peças de motores que não estão sujeitas a alta pressão e aplicações que requeiram resistência a altas temperaturas. Adere a substratos não porosos, incluindo vidro, madeira revestida, cerâmica e esmalte. Não é adequado para PE, PP, PC, PMMA, PTFE, plásticos macios, neoprene e substratos betuminosos.
Não pode ser pintado.



ml	€	🛒	📄
200	29,00	12	098410020
200		12	098412020

9851

cola instantânea para juntas estruturais

com base em etil cianoacrilato para colar uma ampla gama de materiais, incluindo metal, plásticos, couro, madeira e diversos outros tipos de substratos, combinados ou separados; adere rapidamente.



Temperatura (°C)	-55/+82
Viscosidade (mPa.s) 25 °C	80-120

g	€	🛒	📄
5 tubo	6,30	12	098510500
20 frasco	12,30	12	098510002
50 frasco	23,90	10	098510005
5 tubo		12	098512500
20 frasco		12	098512002
50 frasco		10	098512005

9710 - LUBRIBETA universal

desbloqueador lubrificante multiuso 7 funções

1. Desbloqueante;
 2. Lubrificante;
 3. Detergente;
 4. Protetivo contra ferrugem;
 5. Desoxidante para contactos eléctricos;
 6. À prova de água;
 7. Anticongelante
- Não contém silicone.



ml	€	🛒	📄
400		12	097100040
400	10,30	12	097101040
400		12	097102040



9712 - Ultra Sblock

desbloqueador, super-penetrante

Desbloqueante, desoxidante e à prova de água
Apropriado para dissolver a ferrugem de porcas, cavilhas, parafusos e engrenagens.



ml	€	🛒	📄
400		12	097120040
400	7,10	12	097121040
400		12	097122040

9720 - Multi Grease

massa lubrificante spray multiuso

Muito indicado para a lubrificação de correntes, engrenagens e partes metálicas em movimento.
Resiste aos atritos e aos agentes atmosféricos.
Altamente adesivo. Não pinga.



ml	€	🛒	📄
400		12	097200040
400	8,40	12	097201040
400		12	097202040

9722 - Lithium Grease

massa branca spray de lítio

A base de massas saponificadas de lítio, titânio e óxidos de zinco.
Apropriada para engrenagens, rolamentos e rótulas.
Específica para aplicações marítimas.
Bastante resistente à água, salinidade, agentes atmosféricos e altas temperaturas (até 150 °C).
Não pinga.



ml	€	🛒	📄
400		12	097220040
400	9,70	12	097221040
400		12	097222040

9724 - PTFE Grease

massa spray a base de P.T.F.E.

Especificamente indicado para a lubrificação de correntes industriais e movimentos mecânicos com alta pressão e rotações não elevadas.

Apropriada para aplicações em plástico e borracha.

Totalmente incolor. À prova de água e resistente à oxidação.



ml	€		
400		12	097240040
400	10,90	12	097241040
400		12	097242040

9726 - Copper Grease

massa spray com cobre micronizado

Para a lubrificação de rótulas, cavilhas, engrenagens, veios de motor e outras partes metálicas sujeitas a temperaturas elevadas (até 1.000 °C).

Protetivo, anti-desgaste. Previne a oxidação. Não pinga.



ml	€		
400		12	097260040
400	13,00	12	097261040
400		12	097262040

9729 - Silic Spray

silicone spray

Apropriado para a lubrificação das partes em plástico, borracha e metais.

Protege contra a corrosão. Destacante. Anti-estático. À prova de água.

Abrilhantador para madeira, plástico e borracha. Não contém solventes.



ml	€		
400		12	097290040
400	7,50	12	097291040
400		12	097292040

9738 - Cutting Oil

Óleo de corte

Altamente lubrificante e protetor.

Adequado para fresagem, mandrilagem, roscagem, perfuração, trabalho manual e automático da máquina.

Altamente resistente à oxidação

Lavável com água. Isento de solventes.



ml	€		
400		12	097380040
400	8,20	12	097381040
400		12	097382040

9740 - Brake Cleaner

limpador de travões

Apropriado para a limpeza de discos e pastilhas de travões, motores.

Elimina massa e alcatrão, sem deixar resíduos.

Evaporação rápida. Não danifica borracha e plástico.



ml	€		
500		12	097400050
500	7,40	12	097401050
500		12	097402050

9741 - Multi Cleaner

detergente/desengordurante multifunções

Detergente e desengordurante para dissolver gordura, óleo, alcatrão, silicone e cola.

Adequado para limpeza de metal, plástico duro, cerâmica, superfícies em aço e alumínio.

Sem resíduos.



ml	€		
400		12	097410040
400	8,10	12	097411040
400		12	097412040

9742 - Contact Cleaner

limpador para contactos eléctricos e electrónicos

Elimina gordura e sujidade, sem deixar resíduos oleosos.

Evaporação rápida. Não danifica borracha e plástico.



ml	€		
400		12	097420040
400	7,70	12	097421040
400		12	097422040

9743 - SURFACE CLEANER

detergente em espuma

Detergente em espuma para todo o tipo de superfícies, ferramentas e tecidos.

Com composição em sais quaternários de amónio, forma uma espuma ativa que limpa e remove sujidade e gordura.

Elimina maus odores. Não necessita esfregar. Não é um desinfetante.



ml	€		
500		12	097430050
500	15,50	12	097431050
500		12	097432050

9745 - Carb Cleaner

limpador para carburadores e corpos borboleta

Específico para a limpeza interna e externa de carburadores, tubos de aspiração e corpos borboleta.

Elimina totalmente os resíduos carbonosos, depósitos e impurezas.

Não deixa resíduos oleosos.



ml	€		
400		12	097450040
400	8,20	12	097451040
400		12	097452040

9746 - Clima Cleaner

spray para limpeza de aparelhos de ar-condicionado

Para limpeza de aparelhos de ar-condicionado industriais, civis e auto. Com base na sua formulação de espuma espessa e na cânula fornecida, permite a remoção de sujidade, depósitos e odores das condutas, deixando um agradável perfume.



ml	€		
400		12	097460040
400	13,50	12	097461040
400		12	097462040

9749 - Air Spray

spray de gás comprimido

Ideal para remover depósitos de poeira de fissuras, engrenagens, peças elétricas, teclados e mecanismos delicados em geral. A lata de aerossol com cânula permite alcançar peças de difícil acesso.



ml	€		
400		12	097490040
400	8,60	12	097491040
400		12	097492040

9752 - Zinc 98%

zinco claro

Com elevado poder de cobertura, é apropriado para zincar partes em ferro. Altamente adesivo, cria um filme elástico de cor muito clara, semelhante à zincagem a quente. Bastante resistente à oxidação, abrasão e agentes atmosféricos. Pode ser envernizado. Não pinga.



ml	€		
400		12	097520040
400	9,40	12	097521040
400		12	097522040

9755 - Welding Spray

spray anti-salpicos de soldadura

Spray anti-salpicos de soldadura sem silicone. Evita que escórias e salpicos de metal, resultantes de soldadura adiram à superfície. Para utilização em peças que necessitem de soldadura e como protetor de bicos de tochas de soldadura. Permite realizar operações subsequentes, por ex. pintura, galvanização e cromagem. Sem vapores. Fácil de remover. Sem cloro.



ml	€		
400		12	097550040
400	8,50	12	097551040
400		12	097552040

9765 - Deicer Spray

spray descongelante

Spray descongelante para remover gelo e geada das janelas. Também ideal para fechaduras e mecanismos congelados. Eficaz até -40 ° C. Não gorduroso, sem manchas. Não afeta superfícies tratadas, borracha e plásticos.



ml	€		
400		12	097650040
400	14,10	12	097651040
400		12	097652040

9775 - Water Stop

spray impermeabilizante para tecido

Spray impermeabilizante e hidrorrepelente para têxteis e couro. Ideal para calçado, casacos e roupas em geral. Permite a impermeabilização dos tecidos, sem afetar a respirabilidade. Com base nas suas propriedades de resistência a manchas, os tecidos são mais fáceis de lavar. Maior resistência à flexão e abrasão.



ml	€		
400		12	097750040
400	15,20	12	097751040
400		12	097752040

9881U

detergente industrial alcalino para tanque de limpeza com ultrasons

Detergente industrial alcalino, concentrado, à base de água. Para limpeza com ultrasons e outros processos de purificação. Adequado limpeza precisa e eficaz das peças metálicas em geral (injetores, carburadores, válvulas, etc). Remove óleo, gordura, lubrificantes, resíduos de cola, resina e cera. Apropriado também para limpeza de peças em alumínio.



Lt	€		
1	39,50	1	098810010
1		1	098812010

9882R

líquido removedor de ferrugem

removedor de ferrugem líquido à base de álcool para, ferro, aço, aço inox, ferro fundido e cromados. Remove a camada oxidada superior, sem afetar o metal subjacente. Diluir: de puro a max. 1:1 Temperatura recomendada: 15°C Tempo de atuação: 30' - 24/48h (para ferrugem pesada) Biodegradável e 100% solúvel em água.



Lt	€		
1	47,50	1	098820010
1		1	098822010





Uma ampla gama de abrasivos rígidos e flexíveis, que inclui mais de 500 artigos, totalmente fabricada em Itália. Concebida e desenvolvida para satisfazer todos os requisitos de corte e remoção de material em utilizações industriais e profissionais.

A Beta Utensili lançou o projeto Beta Abrasives, assumindo com determinação o objetivo de oferecer aos profissionais uma linha abrangente e de qualidade inexcelável, resultado dos conhecimentos de fabrico da AbraBeta.



DISCOS DE CORTE E REBARBAR RÍGIDOS

Os discos rígidos representam a principal categoria desta nova família de produtos, pelo que a Beta Utensili selecionou os melhores materiais.

Os discos de corte e rebarbar são os instrumentos mais rápidos e versáteis para processamento de uma enorme variedade de materiais, utilizando as ferramentas adequadas, quer se trate de rebarbadoras ou máquinas estacionárias.

FORMATO DOS DISCOS

T42

Disco de corte centro côncavo

T41

Disco de corte centro plano

T27

Disco de rebarbar centro côncavo



Qualidade inquestionável: para utilizadores extremamente exigentes



Alta qualidade para alta performance, a preços competitivos, para a melhor relação qualidade/preço.

CERTIFICAÇÃO



PICTOGRAMAS nos discos



Utilize óculos de proteção



Utilize luvas de proteção



Utilize protetores auditivos



Utilize vestuário de proteção



Utilize máscara anti-poeiras



Consulte o manual do utilizador



Disco apenas para cortar – não adequado para rebarbar



Não utilize o disco se estiver danificado



Isento de ferro, enxofre e cloro ($\leq 0.1\%$)

Validade do produto

Validade do produto: 3 anos a partir da data de fabrico. A gravação "V01" na anilha metálica no centro do disco indica o trimestre de validade. Exemplo: "V07/2022" indica que o disco foi fabricado no terceiro trimestre de 2019 e pode ser usado até ao fim do 3o trimestre de 2022.

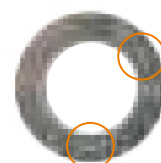

	Trimestre
V01	Jan-Mar
V04	Abr-Jun
V07	Jul-Set
V10	Out-Dez



MÓS MONTADAS

Mós montadas para utilização com retificadoras. Disponíveis em vários formatos para se adaptarem a diferentes processos de trabalho, com três tipos de abrasivos.



LAMELAS DE LIXA

As lamelas flexíveis permitem um acabamento preciso e homogêneo em formas ou superfícies irregulares.



DISCOS LAMELARES

Discos lamelares fabricados em tecido abrasivo colado sobre suporte; são uma excelente opção para operações de desbaste e acabamento. De uma forma geral, garantem uma remoção de material mais rápida, um acabamento mais homogêneo, menor vibração, menos ruído e temperaturas de trabalho menores do que com discos de rebarbar. Disponíveis com tecidos de vários materiais abrasivos, com diferentes tamanhos de grão e dois tipos de suporte.

Formatos



Plano

Utilização num ângulo máximo de 15° em relação à superfície de trabalho, para processar superfícies planas e arestas.



Cónico

Utilização em ângulos entre 15° e 25° em relação à superfície de trabalho, para maior facilidade de processamento de superfícies irregulares. Assegura uma maior superfície de contacto entre o disco e o material. As lamelas podem ser usadas até ao desgaste total.

TOP

— LINE —

Qualidade inquestionável: para utilizadores extremamente exigentes.

PREMIUM

— LINE —

Alta qualidade para alta performance, a preços competitivos, para a melhor relação qualidade/preço.



ROLOS DE LAMELAS

Os rolos de lamelas são adequados para arestas, contornos e superfícies irregulares, com lamelas de elevada flexibilidade.



ROLOS DE LAMELAS PARA ACETINADORAS

Os rolos de lamelas da Beta para acetinadoras são a melhor solução para acabamentos em qualquer material.

Gradi di grana/finitura

C	Coarse
M	Medium
F	Fine
VF	Very Fine
UF	Ultra fine



DISCOS DE FIBRA E RADIAIS

Discos especiais em não-tecido para um efeito de polimento extraordinário, resultando em processos de trabalho rápidos e precisos.



ROLOS DE LIXA OU NÃO-TECIDO

Ampla gama de rolos em lixa ou em não-tecido, de excelente qualidade, para inúmeras utilizações.

Para informação adicional, consulte o respetivo catálogo disponível no website Beta:
www.beta-tools.com

11001

discos abrasivos de corte para aço
execução com centro deprimido

A30S EN 12413



A30S



	Ø mm	S mm	F mm	max. rpm	€		
11001	115	3,2	22,23	13300	2,03	10	110010118
11001	125	3,2	22,23	12200	2,15	10	110010128
11001	230	3,2	22,23	6600	4,70	10	110010233

11001H

discos abrasivos de corte para aço
execução com centro deprimido

HARD

A30T EN 12413



A30T



	Ø mm	S mm	F mm	max. rpm	€		
11001H	230	3,2	22,23	6600	4,70	10	110010733

11003

discos abrasivos de corte para aço
execução com centro plano

A30T EN 12413



A30T



	Ø mm	S mm	F mm	max. rpm	€		
11003	115	2,5	22,23	13300	1,91	10	110030117
11003	125	2,5	22,23	12200	1,91	10	110030127
11003	180	2,5	22,23	8500	3,95	10	110030182
11003	230	2,5	22,23	6600	4,40	10	110030232

11011

discos abrasivos de desbaste para aço
execução com centro deprimido

A24N EN 12413



A24N



	Ø mm	S mm	F mm	max. rpm	€		
11011	115	6,5	22,23	13300	2,75	10	110110115
11011	125	6,5	22,23	12200	2,99	10	110110125
11011	180	6,5	22,23	8500	5,80	10	110110180
11011	230	6,5	22,23	6600	8,70	10	110110230

11011H

discos abrasivos de desbaste para aço
execução com centro deprimido

HARD

A24R EN 12413



A24R



	Ø mm	S mm	F mm	max. rpm	€		
11011H	115	6,5	22,23	13300	2,75	10	110110615
11011H	125	6,5	22,23	12200	2,99	10	110110625
11011H	180	6,5	22,23	8500	5,80	10	110110680
11011H	230	6,5	22,23	6600	8,70	10	110110730

11018

discos abrasivos para cortar aço
execução com centro plano

60 m/s

A46N EN 12413



A46N



	Ø mm	S mm	F mm	max. rpm	€		
11018	300	2,5	25,40	4010	7,70	10	110180030
11018	350	3,0	25,40	3440	12,00	10	110180035
11018	400	3,2	25,40	3010	15,30	10	110180040

11019

discos abrasivos para cortar aço
execução com centro plano

80 m/s

A24N EN 12413



A24N



	Ø mm	S mm	F mm	max. rpm	€		
11019	300	3,8	25,40	5100	9,40	10	110190030
11019	350	4,2	25,40	4400	14,20	10	110190035
11019	400	4,5	25,40	3800	18,40	10	110190040

11021

discos abrasivos de corte para aço e inox
execução com centro deprimido

A30Q EN 12413



A30Q



	Ø mm	S mm	F mm	max. rpm	€		
11021	115	3,2	22,23	13300	2,03	10	110210118
11021	125	3,2	22,23	12200	2,15	10	110210128
11021	180	3,2	22,23	8500	4,10	10	110210183
11021	230	3,2	22,23	6600	4,70	10	110210233

11023

discos abrasivos de desbaste para aço e inox
execução com centro deprimido

A24Q EN 12413



A24Q



	Ø mm	S mm	F mm	max. rpm	€		
11023	115	6,5	22,23	13300	2,75	10	110230115
11023	125	6,5	22,23	12200	2,99	10	110230125
11023	230	6,5	22,23	6600	8,70	10	110230230

11024

discos abrasivos de corte para aço e inox
execução de espessura fina e centro deprimido

TOP LINE

A46U EN 12413



A46U



	Ø mm	S mm	F mm	max. rpm	€		
11024	230	2,0	22,23	6600	5,80	10	110240230

11031÷11038

discos abrasivos de corte para aço e inox
execução de espessura fina e centro plano

TOP LINE

Ø 65 mm

A46U EN 12413



A46U



	Ø mm	S mm	F mm	max. rpm	€		
11031	65	1,0	6,00	24000	1,79	25	110310006
11031	65	1,0	10,00	24000	1,79	25	110310010
11031	65	1,6	10,00	24000	1,79	25	110310020

	Ø mm	S mm	F mm	max. rpm	€		
11032	76	1,0	6,00	20200	1,79	25	110320006
11032	76	1,0	10,00	20200	1,79	25	110320010
11032	76	1,6	10,00	20200	1,79	25	110320020

	Ø mm	S mm	F mm	max. rpm	€		
11034	115	1,0	22,23	13300	2,63	25	110340022
11034	115	1,2	22,23	13300	2,63	25	110340042
11034	115	1,6	22,23	13300	2,63	25	110340062

	Ø mm	S mm	F mm	max. rpm	€		
11035	125	1,0	22,23	12200	2,87	25	110350022
11035	125	1,2	22,23	12200	2,87	25	110350042
11035	125	1,6	22,23	12200	2,87	25	110350062

	Ø mm	S mm	F mm	max. rpm	€		
11037	180	2,0	22,23	8500	4,70	10	110370022

	Ø mm	S mm	F mm	max. rpm	€		
11038	230	2,0	22,23	6600	5,40	10	110380022

11040

discos abrasivos de corte para aço e inox
execução de espessura fina e centro deprimido

PREMIUM LINE

A36Q EN 12413



A36Q



	Ø mm	S mm	F mm	max. rpm	€		
11040	230	2,0	22,23	6600	4,40	10	110400230

11045-11046

discos abrasivos de corte para aço e inox
execução de espessura fina e centro plano

PREMIUM LINE

Ø 115 mm

A46Q EN 12413



A46Q

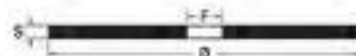

	Ø mm	S mm	F mm	max. rpm	€		
11045	115	1,0	22,23	13300	2,03	25	110450010
11045	115	1,2	22,23	13300	2,03	25	110450012
11045	115	1,6	22,23	13300	2,03	25	110450016
11046	125	1,0	22,23	12200	2,15	25	110460010
11046	125	1,2	22,23	12200	2,15	25	110460012
11046	125	1,6	22,23	12200	2,15	25	110460016

11048-11049

discos abrasivos de corte para aço e inox
execução de espessura fina e centro plano

Ø 180 mm

A36Q EN 12413



A36Q

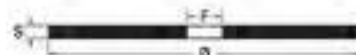

	Ø mm	S mm	F mm	max. rpm	€		
11048	180	2,0	22,23	8500	3,10	10	110480019

	Ø mm	S mm	F mm	max. rpm	€		
11049	230	2,0	22,23	6600	4,20	10	110490019

11050

discos abrasivos de desbaste para aço e ferro fundido
execução de zircônia e com centro deprimido

ZA24R - EN 12413



ZA24R



	Ø mm	S mm	F mm	max. rpm	€		
11050	115	6,5	22,23	13300	4,70	10	110500115
11050	125	6,5	22,23	12200	5,70	10	110500125
11050	230	7,0	22,23	6600	14,20	10	110500230

11069

discos abrasivos de corte para pedra e mármore
execução com centro deprimido

C30S EN 12413



C30S



	Ø mm	S mm	F mm	max. rpm	€		
11069	115	3,2	22,23	13300	2,15	10	110690115
11069	125	3,2	22,23	12200	2,27	10	110690125
11069	230	3,2	22,23	6600	5,10	10	110690230

Beta

11100

mós montadas abrasivas
grãos abrasivos de corindon rosa
forma cilíndrica

haste Ø 3 x 37 mm

EN 12413



	Ø mm	h mm	max. rpm Lo=13 mm		€		
11100	4	8	130.000	AR60P5V	1,16	25	111000004
11100	6	10	93.100	AR60P5V	1,16	25	111000006
11100	8	12	64.500	AR60P5V	1,16	25	111000008
11100	10	10	60.100	AR60P5V	1,16	25	111000011
11100	10	12	52.700	AR60P5V	1,16	25	111000012
11100	12	15	37.300	AR60P5V	1,28	25	111000013

11101

mós montadas abrasivas
grãos abrasivos de corindon rosa
forma cilíndrica

haste Ø 6 x 40 mm

EN 12413

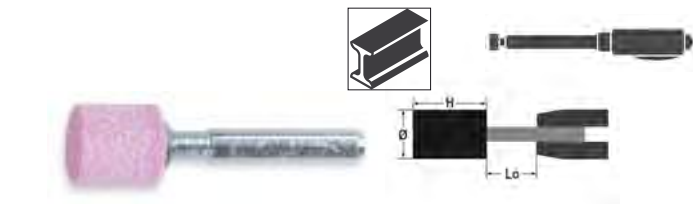

	Ø mm	h mm	max. rpm Lo=13 mm		€		
11101	4	8	130.000	AR60P5V	1,36	25	111010004
11101	5	10	130.000	AR60P5V	1,36	25	111010005
11101	6	10	130.000	AR60P5V	1,36	25	111010006
11101	8	10	119.300	AR60P5V	1,36	25	111010008
11101	10	10	95.400	AR60P5V	1,36	25	111010010
11101	10	15	95.400	AR60P5V	1,36	25	111010011
11101	10	20	86.600	AR60P5V	1,48	25	111010012
11101	10	25	72.700	AR60P5V	1,64	25	111010013
11101	10	32	58.700	AR60P5V	1,72	25	111010014
11101	12	10	79.500	AR60P5V	1,26	25	111010015
11101	12	15	79.500	AR60P5V	1,28	25	111010016
11101	12	20	79.500	AR60P5V	1,40	25	111010017
11101	15	3	63.600	AR60P5V	1,26	25	111010018
11101	15	15	63.600	AR60P5V	1,36	25	111010019
11101	16	20	59.600	AR46P5V	1,53	25	111010020
11101	16	25	56.900	AR46P5V	1,64	25	111010021
11101	16	32	45.100	AR46P5V	1,84	25	111010022
11101	20	4	47.700	AR60P5V	1,26	25	111010023
11101	20	15	47.700	AR46P5V	1,36	25	111010024
11101	20	20	47.700	AR46P5V	1,64	25	111010025
11101	20	25	46.100	AR46P5V	1,72	25	111010026
11101	20	30	38.900	AR46P5V	1,89	25	111010027
11101	20	40	29.000	AR46P5V	2,37	25	111010028
11101	25	10	38.100	AR60P5V	1,36	25	111010030
11101	25	25	37.200	AR36/46P5V	1,89	25	111010031
11101	25	40	23.300	AR36/46P5V	2,77	10	111010032
11101	30	10	31.800	AR60P5V	1,53	25	111010034
11101	30	30	26.200	AR36/46P5V	2,26	25	111010035
11101	30	40	19.500	AR36/46P5V	3,00	10	111010036
11101	32	20	29.800	AR36P5V	2,12	25	111010037
11101	32	32	23.100	AR36P5V	2,89	10	111010038
11101	40	10	23.800	AR36/46P5V	2,26	25	111010041
11101	40	20	23.800	AR36P5V	3,00	10	111010042
11101	40	25	23.400	AR36P5V	3,15	10	111010043
11101	40	30	19.700	AR36P5V	3,50	10	111010044
11101	40	40	14.700	AR36P5V	4,20	10	111010045
11101	50	15	19.000	AR36P5V	3,35	10	111010051
11101	50	25	18.800	AR36P5V	4,05	10	111010052
11101	60	10	15.900	AR36P5V	3,70	10	111010060

11102

mós montadas abrasivas
grãos abrasivos de corindon rosa
forma cilíndrica

haste Ø 6 x 80 mm

EN 12413

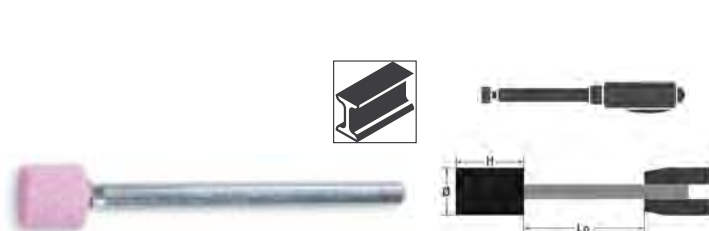

	Ø mm	h mm	max. rpm Lo=13 mm		€		
11102	8	20	100.500	AR60P5V	1,77	25	111020008
11102	10	15	95.400	AR60P5V	1,67	25	111020010
11102	10	30	62.200	AR60P5V	2,04	25	111020020
11102	12	15	79.500	AR60P5V	1,72	25	111020022
11102	15	15	63.600	AR60P5V	1,84	25	111020035
11102	15	30	51.000	AR46P5V	2,29	25	111020040
11102	20	30	38.900	AR46P5V	2,32	25	111020060

11105

mós montadas abrasivas
grãos abrasivos de corindon rosa
forma cilindro triangular

haste Ø 6 x 40 mm

EN 12413

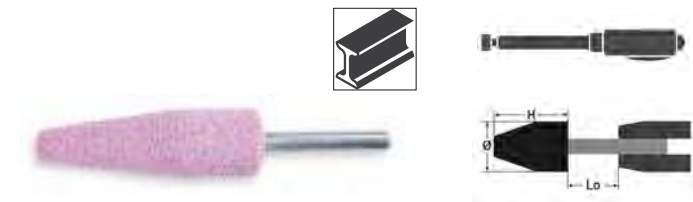

	Ø mm	h mm	max. rpm Lo=13 mm		€		
11105	20	65	16.200	AR36/46P5V	4,40	25	111050020

11106

mós montadas abrasivas
grãos abrasivos de corindon rosa
forma trapezoidal

haste Ø 3 x 37 mm

EN 12413

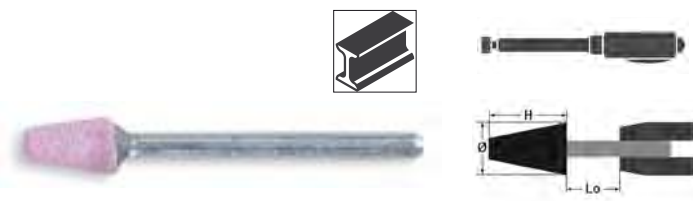

	Ø mm	h mm	max. rpm Lo=13 mm		€		
11106	6	10	93.100	AR60P5V	1,53	25	111060006

11107

mós montadas abrasivas
grãos abrasivos de coríndon rosa
forma trapezoidal

haste Ø 6 x 40 mm

EN 12413



	Ø mm	h mm	max. rpm Lo=13 mm		€		
11107	12	20	79.500	AR60P5V	1,72	25	111070012
11107	15	25	60.400	AR46P5V	2,04	25	111070015
11107	20	30	38.900	AR46P5V	2,37	25	111070020
11107	25	40	23.300	AR36/46P5V	3,50	10	111070025

11110

mós montadas abrasivas
grãos abrasivos de coríndon rosa
forma cônica arredondada

haste Ø 3 x 37 mm

EN 12413



	Ø mm	h mm	max. rpm Lo=13 mm		€		
11110	10	15	44.300	AR60P5V	1,53	25	111100010

11111

mós montadas abrasivas
grãos abrasivos de coríndon rosa
forma cônica arredondada

haste Ø 6 x 40 mm

EN 12413



	Ø mm	h mm	max. rpm Lo=13 mm		€		
11111	10	20	86.600	AR60P5V	1,77	25	111110010
11111	15	30	51.000	AR46P5V	2,32	25	111110015
11111	16	45	31.400	AR46P5V	3,15	25	111110016
11111	20	28	41.500	AR46P5V	2,37	25	111110020
11111	20	40	29.000	AR46P5V	3,00	25	111110021
11111	30	50	15.100	AR36/46P5V	4,40	10	111110030

11115

mós montadas abrasivas
grãos abrasivos de coríndon rosa
forma ogiva

haste Ø 3 x 37 mm

EN 12413

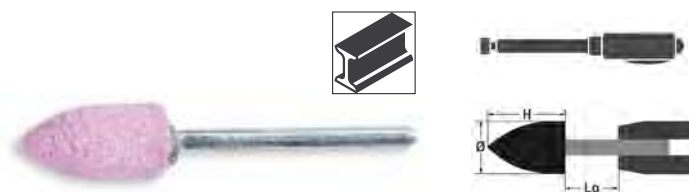

	Ø mm	h mm	max. rpm Lo=13 mm		€		
11115	10	20	34.700	AR60P5V	1,64	25	111150010

11116

mós montadas abrasivas
grãos abrasivos de coríndon rosa
forma ogiva

haste Ø 6 x 40 mm

EN 12413

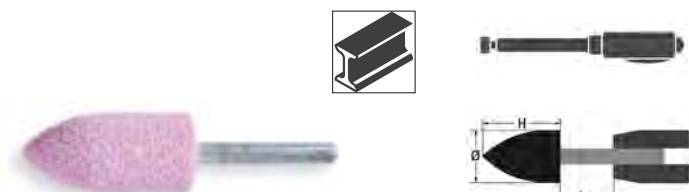

	Ø mm	h mm	max. rpm Lo=13 mm		€		
11116	10	20	86.600	AR60P5V	1,77	25	111160010
11116	18	30	43.000	AR46P5V	2,37	25	111160018
11116	20	50	22.500	AR36/46P5V	3,70	25	111160020
11116	22	70	13.400	AR36/46P5V	5,70	10	111160022

11120

mós montadas abrasivas
grãos abrasivos de coríndon rosa
forma cilindro pirâmide

haste Ø 3 x 37 mm

EN 12413

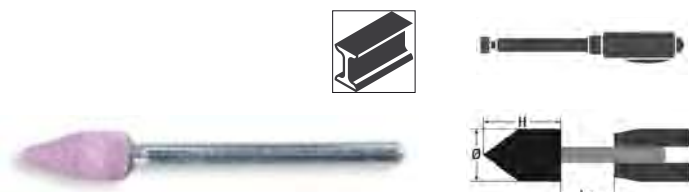

	Ø mm	h mm	max. rpm Lo=13 mm		€		
11120	6	13	77.800	AR60P5V	1,53	25	111200006

Beta

11121

mós montadas abrasivas
grãos abrasivos de coríndon rosa
forma cilindro pirâmide

haste Ø 6 x 40 mm

EN 12413



	Ø mm	h mm	max. rpm Lo=13 mm		€		
11121	6	25	100.700	AR60P5V	2,37	25	111210007
11121	12	20	79.500	AR60P5V	1,72	25	111210012
11121	20	25	46.100	AR46P5V	2,14	25	111210020
11121	25	25	37.200	AR36/46P5V	2,37	25	111210025
11121	30	30	26.200	AR36/46P5V	2,83	25	111210030

11125

mós montadas abrasivas
grãos abrasivos de coríndon rosa
forma cilindro arredondado

haste Ø 6 x 40 mm

EN 12413

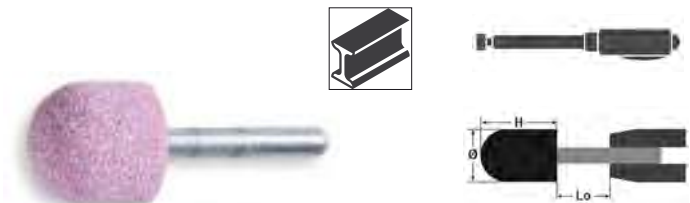

	Ø mm	h mm	max. rpm Lo=13 mm		€		
11125	6	20	117.700	AR60P5V	1,92	25	111250006
11125	25	25	37.200	AR36/46P5V	2,37	25	111250025
11125	30	50	15.100	AR36/46P5V	4,40	10	111250030
11125	40	40	14.700	AR36P5V	5,40	10	111250040

11130

mós montadas abrasivas
grãos abrasivos de coríndon rosa
forma esférica

haste Ø 3 x 37 mm

EN 12413



	Ø mm	h mm	max. rpm Lo=13 mm		€		
11130	6	6	124.900	AR60P5V	1,53	25	111300006
11130	8	8	84.800	AR60P5V	1,53	25	111300008
11130	10	10	60.100	AR60P5V	1,53	25	111300010

11131

mós montadas abrasivas
grãos abrasivos de coríndon rosa
forma esférica

haste Ø 6 x 40 mm

EN 12413



	Ø mm	h mm	max. rpm Lo=13 mm		€		
11131	10	10	95.400	AR60P5V	1,64	25	111310010
11131	15	15	63.600	AR60P5V	1,72	25	111310015
11131	20	20	47.700	AR46P5V	2,04	25	111310020
11131	25	25	37.200	AR36/46P5V	2,37	25	111310025
11131	30	30	26.200	AR36/46P5V	2,83	25	111310030

11132

mós montadas abrasivas
grãos abrasivos de coríndon rosa
forma esférica

haste Ø 6 x 80 mm

EN 12413

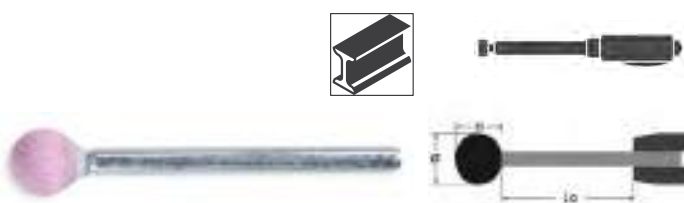

	Ø mm	h mm	max. rpm Lo=13 mm		€		
11132	10	10	95.400	AR60P5V	1,92	25	111320010
11132	15	15	63.600	AR60P5V	2,14	25	111320015
11132	20	20	47.700	AR46P5V	2,53	25	111320020

11135

mós montadas abrasivas
grãos abrasivos de coríndon rosa
forma disco

haste Ø 6 x 40 mm

EN 12413

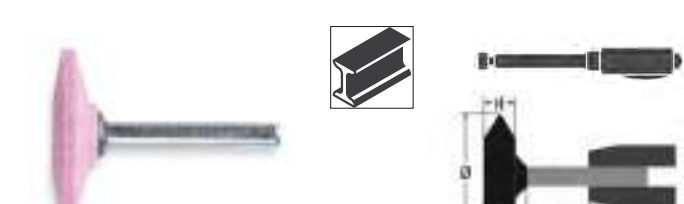

	Ø mm	h mm	max. rpm Lo=13 mm		€		
11135	30	6	31.800	AR60P5V	1,89	25	111350030
11135	40	10	23.800	AR36/46P5V	2,89	25	111350040

11140

mós montadas abrasivas
grãos abrasivos de coríndon cinzento/rosa
forma cilíndrica

haste Ø 6 x 40 mm

EN 12413

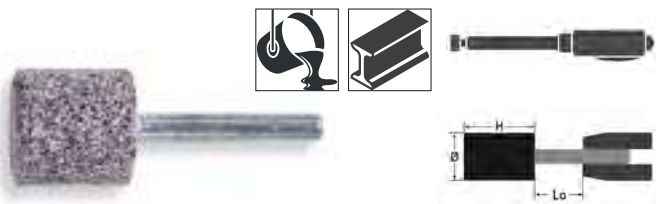

	Ø mm	h mm	max. rpm Lo=13 mm		€		
11140	20	30	38.900	A/AR24R5V	1,89	25	111400020
11140	25	25	37.200	A/AR24R5V	1,89	25	111400025
11140	30	30	26.200	A/AR24R5V	2,26	25	111400030
11140	50	10	19.000	A/AR24R5V	3,00	10	111400050

11141

mós montadas abrasivas
grãos abrasivos de coríndon cinzento/rosa
forma cilíndrica

haste Ø 6 x 80 mm

EN 12413



	Ø mm	h mm	max. rpm Lo=13 mm		€		
11141	20	40	46.800	A/AR24R5V	2,67	25	111410020
11141	30	40	31.800	A/AR24R5V	3,25	10	111410030
11141	40	40	23.800	A/AR24R5V	4,55	10	111410040

11145

mós montadas abrasivas
grãos abrasivos de coríndon cinzento/rosa
forma ogiva

haste Ø 6 x 40 mm

EN 12413



	Ø mm	h mm	max. rpm Lo=13 mm		€		
11145	20	30	38.900	A/AR24R5V	2,37	25	111450020
11145	25	50	18.100	A/AR24R5V	4,20	10	111450025

11200A-11200B

discos lamelados com tela abrasiva de zircónia
suporte em plástico e lâmina simples

Execução plana

PREMIUM LINE

Ø 115 mm

EN 13743



	Ø mm	P	F mm		€		
11200A	115	40	22,23		3,35	10	112000004
11200A	115	60	22,23		3,35	10	112000006
11200A	115	80	22,23		3,35	10	112000008
11200A	115	120	22,23		3,35	10	112000012

	Ø mm	P	F mm		€		
11200B	125	40	22,23		4,10	10	112000104
11200B	125	60	22,23		4,10	10	112000106
11200B	125	80	22,23		4,10	10	112000108

11202A÷11202C

discos lamelados com tela abrasiva de zircónia
suporte em plástico e lâmina dupla

Execução plana

PREMIUM LINE

Ø 115 mm

EN 13743



	Ø mm	P	F mm		€		
11202A	115	40	22,23		3,35	10	112020004
11202A	115	60	22,23		3,35	10	112020006
11202A	115	80	22,23		3,35	10	112020008
11202A	115	120	22,23		3,35	10	112020012

	Ø mm	P	F mm		€		
11202B	125	40	22,23		4,10	10	112020104
11202B	125	60	22,23		4,10	10	112020106
11202B	125	80	22,23		4,10	10	112020108

	Ø mm	P	F mm		€		
11202C	180	40	22,23		8,70	10	112020204
11202C	180	60	22,23		8,70	10	112020206

11204A-11204B

discos lamelados com tela abrasiva de zircónia
suporte em fibra de vidro e lâmina simples

Execução plana
PREMIUM LINE
Ø 115 mm
EN 13743



	Ø mm	P	F mm	€		
11204A	115	40	22,23	3,35	10	112040004
11204A	115	60	22,23	3,35	10	112040006
11204A	115	80	22,23	3,35	10	112040008
11204A	115	120	22,23	3,35	10	112040012

	Ø mm	P	F mm	€		
11204B	125	40	22,23	4,10	10	112040104
11204B	125	60	22,23	4,10	10	112040106
11204B	125	80	22,23	4,10	10	112040108

11208A-11208B

discos lamelados com tela abrasiva de zircónia
suporte em fibra de vidro e lâmina dupla

Execução plana
PREMIUM LINE
Ø 115 mm
EN 13743



	Ø mm	P	F mm	€		
11208A	115	40	22,23	3,35	10	112080004
11208A	115	60	22,23	3,35	10	112080006

	Ø mm	P	F mm	€		
11208B	125	40	22,23	4,10	10	112080104
11208B	125	60	22,23	4,10	10	112080106

11210A-11210B

discos lamelados com tela abrasiva de zircónia
suporte em fibra de vidro e lâmina simples

Execução cônica
PREMIUM LINE
Ø 115 mm
EN 13743



	Ø mm	P	F mm	€		
11210A	115	40	22,23	3,35	10	112100004
11210A	115	60	22,23	3,35	10	112100006
11210A	115	80	22,23	3,35	10	112100008
11210A	115	120	22,23	3,35	10	112100012

	Ø mm	P	F mm	€		
11210B	125	40	22,23	4,10	10	112100104
11210B	125	60	22,23	4,10	10	112100106
11210B	125	80	22,23	4,10	10	112100108

11212A-11212B

discos lamelados com tela abrasiva de zircónia
suporte em plástico e lâmina simples

Execução plana
TOP LINE
Ø 115 mm
EN 13743



	Ø mm	P	F mm	€		
11212A	115	40	22,23	4,20	10	112120004
11212A	115	60	22,23	4,20	10	112120006
11212A	115	80	22,23	4,20	10	112120008
11212A	115	120	22,23	4,20	10	112120012

	Ø mm	P	F mm	€		
11212B	125	40	22,23	5,20	10	112120104
11212B	125	60	22,23	5,20	10	112120106
11212B	125	80	22,23	5,20	10	112120108



11214A+11214C

discos lamelados com tela abrasiva de zircônia
suporte em plástico e lâmina dupla

Execução plana
TOP LINE
Ø 115 mm
EN 13743



	Ø mm	P	F mm	€		
11214A	115	40	22,23	4,20	10	112140004
11214A	115	60	22,23	4,20	10	112140006
11214A	115	80	22,23	4,20	10	112140008
11214A	115	120	22,23	4,20	10	112140012

	Ø mm	P	F mm	€		
11214B	125	40	22,23	5,20	10	112140104
11214B	125	60	22,23	5,20	10	112140106
11214B	125	80	22,23	5,20	10	112140108

	Ø mm	P	F mm	€		
11214C	180	40	22,23	10,60	10	112140204
11214C	180	60	22,23	10,60	10	112140206

11216A-11216B

discos lamelados com tela abrasiva de zircônia
suporte em fibra de vidro e lâmina simples

Execução plana
TOP LINE
Ø 115 mm
EN 13743



	Ø mm	P	F mm	€		
11216A	115	40	22,23	4,20	10	112160004
11216A	115	60	22,23	4,20	10	112160006
11216A	115	80	22,23	4,20	10	112160008
11216A	115	120	22,23	4,20	10	112160012

	Ø mm	P	F mm	€		
11216B	125	40	22,23	5,20	10	112160104
11216B	125	60	22,23	5,20	10	112160106
11216B	125	80	22,23	5,20	10	112160108

11218A-11218B

discos lamelados com tela abrasiva de zircônia
suporte em fibra de vidro e lâmina dupla

Execução plana
TOP LINE
Ø 115 mm
EN 13743



	Ø mm	P	F mm	€		
11218A	115	40	22,23	4,20	10	112180004
11218A	115	60	22,23	4,20	10	112180006

	Ø mm	P	F mm	€		
11218B	125	40	22,23	5,20	10	112180104
11218B	125	60	22,23	5,20	10	112180106

11220A-11220B

discos lamelados com tela abrasiva de zircônia
suporte em fibra de vidro e lâmina simples

Execução cônica
TOP LINE
Ø 115 mm
EN 13743



	Ø mm	P	F mm	€		
11220A	115	40	22,23	4,20	10	112200004
11220A	115	60	22,23	4,20	10	112200006
11220A	115	80	22,23	4,20	10	112200008
11220A	115	120	22,23	4,20	10	112200012

	Ø mm	P	F mm	€		
11220B	125	40	22,23	5,20	10	112200104
11220B	125	60	22,23	5,20	10	112200106
11220B	125	80	22,23	5,20	10	112200108

11222B

discos lamelados com tela abrasiva de zircónia
suporte em fibra de vidro e lâmina dupla

Execução cónica
TOP LINE
Ø 115 mm
EN 13743



	Ø mm	P	F mm	€	🔧	📄
11222B	125	40	22,23	5,20	10	112220104
11222B	125	60	22,23	5,20	10	112220106
11222B	125	80	22,23	5,20	10	112220108

11230A-11230B

discos lamelados com tela abrasiva de coríndon
suporte em plástico e lâmina simples

Execução plana
PREMIUM LINE
Ø 115 mm
EN 13743



	Ø mm	P	F mm	€	🔧	📄
11230A	115	40	22,23	3,10	10	112300004
11230A	115	60	22,23	3,10	10	112300006
11230A	115	80	22,23	3,10	10	112300008
11230A	115	120	22,23	3,10	10	112300012

	Ø mm	P	F mm	€	🔧	📄
11230B	125	40	22,23	3,80	10	112300104
11230B	125	60	22,23	3,80	10	112300106

Beta

11232A

discos laminados com tela abrasiva de coríndon
suporte em plástico e lâmina dupla

Execução plana
PREMIUM LINE
Ø 115 mm
EN 13743



	Ø mm	P	F mm	€	🔧	📄
11232A	115	40	22,23	3,10	10	112320004
11232A	115	60	22,23	3,10	10	112320006
11232A	115	80	22,23	3,10	10	112320008
11232A	115	120	22,23	3,10	10	112320012

11234A

discos laminados com tela abrasiva de coríndon
suporte em fibra de vidro e lâmina simples

Execução plana
TOP LINE
Ø 115 mm
EN 13743



	Ø mm	P	F mm	€	🔧	📄
11234A	115	40	22,23	3,70	10	112340004
11234A	115	60	22,23	3,70	10	112340006
11234A	115	80	22,23	3,70	10	112340008
11234A	115	120	22,23	3,70	10	112340012

Beta

11240A-11240B

discos laminados com tela abrasiva de zircônia cerâmica
suporte em plástico e lâmina simples

Execução plana
Ø 115 mm
EN 13743



	Ø mm	P	F mm	€		
11240A	115	40	22,23	5,90	10	112400004
11240A	115	60	22,23	5,90	10	112400006
11240B	125	40	22,23	7,10	10	112400104
11240B	125	60	22,23	7,10	10	112400106

11242A-11242B

discos laminados com tela abrasiva de zircônia cerâmica
suporte em fibra de vidro e lâmina simples

Execução plana
Ø 115 mm
EN 13743



	Ø mm	P	F mm	€		
11242A	115	40	22,23	5,90	10	112420004
11242A	115	60	22,23	5,90	10	112420006
11242B	125	40	22,23	7,10	10	112420104
11242B	125	60	22,23	7,10	10	112420106

11246A

discos laminados com tela abrasiva cerâmica
suporte em plástico e lâmina simples

Execução plana
Ø 115 mm
EN 13743



	Ø mm	P	F mm	€		
11246A	115	40	22,23	7,20	10	112460004
11246A	115	60	22,23	7,20	10	112460006

11248A-11248B

discos laminados com tela abrasiva cerâmica
suporte em fibra de vidro e lâmina simples

Execução plana
Ø 115 mm
EN 13743



	Ø mm	P	F mm	€		
11248A	115	40	22,23	7,20	10	112480004
11248A	115	60	22,23	7,20	10	112480006
11248B	125	40	22,23	9,40	10	112480104
11248B	125	60	22,23	9,40	10	112480106

11259

discos laminados com lâminas em feltro
suporte em fibra de vidro e lâmina simples

Execução plana



	Ø mm	F mm	€		
11259	115	22,23	11,80	10	112590115
11259	125	22,23	13,60	10	112590125



11260÷11268

rodas com lâminas com haste
lâminas em tela abrasiva de coríndon

haste Ø 3 mm

EN 13743



	Ø mm	h mm	S mm	P	€		
11260	10	10	3	60	5,90	10	112600010
11260	15	15	3	60	4,70	10	112600015

	Ø mm	h mm	S mm	P	€		
11263	30	10	6	60	3,10	10	112630006
11263	30	15	6	60	3,10	10	112630016
11263	30	15	6	80	3,10	10	112630018
11263	30	20	6	40	3,10	10	112630024
11263	30	20	6	60	3,25	10	112630026
11263	30	20	6	80	3,25	10	112630028
11263	30	20	6	120	3,25	10	112630032

	Ø mm	h mm	S mm	P	€		
11264	40	15	6	60	3,35	10	112640006
11264	40	15	6	80	3,35	10	112640008
11264	40	15	6	120	3,35	10	112640012
11264	40	20	6	40	3,50	10	112640014
11264	40	20	6	60	3,50	10	112640016
11264	40	30	6	40	3,95	10	112640024
11264	40	30	6	60	3,95	10	112640026

	Ø mm	h mm	S mm	P	€		
11265	50	20	6	60	4,10	10	112650006
11265	50	20	6	80	4,10	10	112650008
11265	50	30	6	40	4,55	10	112650014
11265	50	30	6	60	4,55	10	112650016
11265	50	30	6	80	4,55	10	112650018
11265	50	30	6	120	4,80	10	112650022

	Ø mm	h mm	S mm	P	€		
11266	60	20	6	40	4,80	10	112660004
11266	60	20	6	60	4,80	10	112660006
11266	60	30	6	40	5,40	10	112660014
11266	60	30	6	60	5,40	10	112660016
11266	60	30	6	80	5,40	10	112660018
11266	60	30	6	120	5,90	10	112660022
11266	60	40	6	60	6,30	10	112660026
11266	60	40	6	80	6,30	10	112660028

	Ø mm	h mm	S mm	P	€		
11268	80	30	6	60	7,50	10	112680006
11268	80	30	6	80	7,50	10	112680008

Beta

11271A÷11271C

rodas em tecido não tecido abrasivo com haste
tecido em fibras sintéticas de coríndon

Ø 40 mm

haste Ø 6 mm



	Ø mm	h mm	S mm	P	€		
11271A	40	20	6	C	7,80	10	112710001
11271A	40	20	6	M	7,80	10	112710002
11271A	40	20	6	F	7,80	10	112710003
11271A	40	20	6	VF	7,80	10	112710004

	Ø mm	h mm	S mm	P	€		
11271B	60	30	6	C	8,80	10	112710011
11271B	60	30	6	M	8,80	10	112710012
11271B	60	30	6	F	8,80	10	112710013
11271B	60	30	6	VF	8,80	10	112710014

	Ø mm	h mm	S mm	P	€		
11271C	80	50	6	C	9,80	10	112710021
11271C	80	50	6	M	9,80	10	112710022
11271C	80	50	6	F	9,80	10	112710023
11271C	80	50	6	VF	9,80	10	112710024

11276A÷11276C

rodas mistas lâminas/tecido não tecido com haste
lâminas em tela abrasiva alternada com tecido em fibras sintéticas de coríndon

Ø 40 mm

haste Ø 6 mm



	Ø mm	h mm	S mm	P	€		
11276A	40	20	6	M/60	8,90	10	112760006
11276A	40	20	6	M/80	8,90	10	112760008
11276A	40	20	6	M/120	8,90	10	112760012

	Ø mm	h mm	S mm	P	€		
11276B	60	30	6	M/60	9,80	10	112760016
11276B	60	30	6	M/80	9,80	10	112760018
11276B	60	30	6	M/120	9,80	10	112760022

Beta

	Ø mm	h mm	S mm	P	€		
11276C	80	50	6	M/60	11,70	10	112760036
11276C	80	50	6	M/80	11,70	10	112760038
11276C	80	50	6	M/120	11,70	10	112760042

11300A÷11300G

rodas laminadas com tela de coríndon com furo

Ø 165 x 30 mm

EN 13743

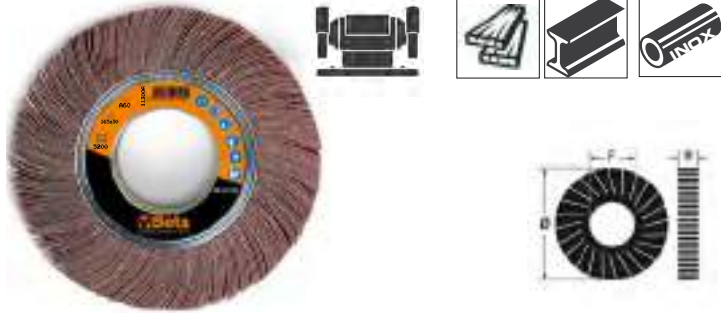

	Ø mm	H mm	P	F mm	€		
11300A	165	30	40	54	32,00	3	113000004
11300A	165	30	60	54	34,00	3	113000006
11300A	165	30	80	54	35,00	3	113000008
11300A	165	30	120	54	38,00	3	113000012
11300A	165	30	180	54	40,00	3	113000018
11300A	165	30	220	54	42,00	3	113000022

	Ø mm	H mm	P	F mm	€		
11300B	165	50	40	54	44,00	2	113000104
11300B	165	50	60	54	47,00	2	113000106
11300B	165	50	80	54	48,00	2	113000108
11300B	165	50	120	54	53,00	2	113000112
11300B	165	50	180	54	59,00	2	113000118
11300B	165	50	220	54	62,50	2	113000122

	Ø mm	H mm	P	F mm	€		
11300C	200	30	40	54	38,00	3	113000204
11300C	200	30	60	54	41,00	3	113000206
11300C	200	30	80	54	44,00	3	113000208
11300C	200	30	120	54	47,00	3	113000212
11300C	200	30	180	54	50,50	3	113000218

	Ø mm	H mm	P	F mm	€		
11300D	200	50	40	54	53,00	2	113000304
11300D	200	50	60	54	59,00	2	113000306
11300D	200	50	80	54	62,50	2	113000308
11300D	200	50	120	54	68,50	2	113000312
11300D	200	50	180	54	74,50	2	113000318
11300D	200	50	220	54	80,50	2	113000322

	Ø mm	H mm	P	F mm	€		
11300E	250	30	40	100	68,50	3	113000404
11300E	250	30	60	100	72,00	3	113000406
11300E	250	30	80	100	74,50	3	113000408
11300E	250	30	120	100	79,50	3	113000412

	Ø mm	H mm	P	F mm	€		
11300F	250	50	40	100	98,50	2	113000504
11300F	250	50	60	100	101,00	2	113000506
11300F	250	50	80	100	104,00	2	113000508
11300F	250	50	120	100	107,00	2	113000512
11300F	250	50	180	100	126,00	2	113000518
11300F	250	50	220	100	138,00	2	113000522

	Ø mm	H mm	P	F mm	€		
11300G	300	50	40	100	132,00	2	113000604
11300G	300	50	60	100	138,00	2	113000606
11300G	300	50	80	100	142,00	2	113000608

11320

rodas em tecido não tecido abrasivo com furo
tecido em fibras sintéticas de coríndon

Ø 200 x 50 mm

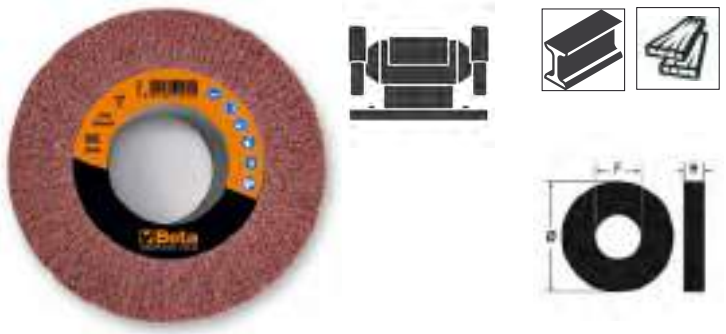

	Ø mm	H mm	P	F mm	€		
11320	200	50	C	76,2	40,00	2	113200006
11320	200	50	M	76,2	40,00	2	113200008
11320	200	50	F	76,2	40,00	2	113200012
11320	200	50	VF	76,2	40,00	2	113200024

11411

rodas laminadas com tela de coríndon para polidoras de metais

Ø 100 x 100 mm

EN 13743

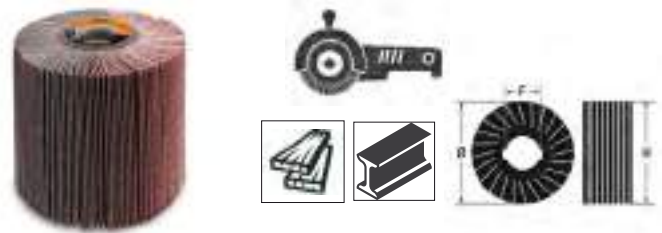

	Ø mm	H mm	P	F mm	€		
11411	100	100	40	19,1	34,00	2	114110004
11411	100	100	60	19,1	37,00	2	114110006
11411	100	100	80	19,1	38,00	2	114110008
11411	100	100	120	19,1	40,00	2	114110012
11411	100	100	240	19,1	41,00	2	114110024

11415B

rodas em tecido não tecido
fibras sintéticas de coríndon para polidoras de metais

Ø 100 x 100 mm

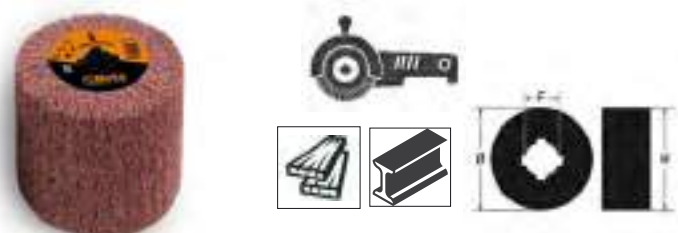

	Ø mm	H mm	P	F mm	€		
11415B	100	100	C	19,1	29,00	2	114150106
11415B	100	100	M	19,1	29,00	2	114150108
11415B	100	100	F	19,1	29,00	2	114150112
11415B	100	100	VF	19,1	29,00	2	114150124

11420B

rodas mistas lâminas/tecido não tecido para polidoras de metais
tela abrasiva alternada com fibras sintéticas de coríndon

Ø 100 x 100 mm

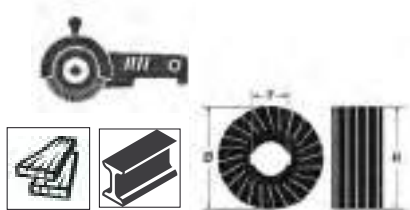

	Ø mm	H mm	P	F mm	€	🚚	📄
11420B	100	100	C/60	19,1	31,00	2	114200106
11420B	100	100	M/80	19,1	31,00	2	114200108
11420B	100	100	F/120	19,1	31,00	2	114200112
11420B	100	100	VF/240	19,1	31,00	2	114200124

11431

discos radiais em tecido não tecido
fibras sintéticas de coríndon

Ø 115 mm



	Ø mm	P	F mm	€	🚚	📄
11431	115	C	22,23	18,00	4	114310006
11431	115	M	22,23	18,00	4	114310008
11431	115	F	22,23	18,00	4	114310012
11431	115	VF	22,23	18,00	4	114310024

11440A÷11440C

discos fibrados com tela de zircónia

Ø 115 mm



	Ø mm	P	F mm	€	🚚	📄
11440A	115	24	22	1,55	25	114400024
11440A	115	36	22	1,55	25	114400036
11440A	115	60	22	1,43	25	114400060
11440A	115	120	22	1,43	25	114400120

	Ø mm	P	F mm	€	🚚	📄
11440B	125	24	22	1,79	25	114400224
11440B	125	36	22	1,79	25	114400236
11440B	125	60	22	1,67	25	114400260
11440B	125	120	22	1,67	25	114400320

	Ø mm	P	F mm	€	🚚	📄
11440C	180	24	22	2,87	25	114400424
11440C	180	36	22	2,87	25	114400436
11440C	180	60	22	2,75	25	114400460
11440C	180	120	22	2,75	25	114400520

11450A÷11450C

discos fibrados com tela de coríndon

Ø 115 mm



	Ø mm	P	F mm	€	🚚	📄
11450A	115	24	22	1,19	25	114500024
11450A	115	36	22	1,19	25	114500036
11450A	115	60	22	1,07	25	114500060
11450A	115	120	22	1,07	25	114500120

	Ø mm	P	F mm	€	🚚	📄
11450B	125	24	22	1,31	25	114500224
11450B	125	36	22	1,31	25	114500236
11450B	125	60	22	1,31	25	114500260
11450B	125	120	22	1,31	25	114500320

	Ø mm	P	F mm	€	🚚	📄
11450C	180	24	22	2,03	25	114500424
11450C	180	36	22	2,03	25	114500436
11450C	180	60	22	1,91	25	114500460
11450C	180	120	22	1,91	25	114500520



11488PF

bases para apoio de discos de fibra com rosca M14



	Ø mm	€		
11488P	115	9,20	1	114880115
11488P	125	10,00	1	114880125
11488P	180	15,30	1	114880180

11491-11493-11495

rolos antidesperdício em tela abrasiva de coríndon

h 38 mm x 50 m



	H mm	L m	P	€		
11491	38	50	40	59,00	1	114910004
11491	38	50	60	58,00	1	114910006
11491	38	50	80	56,50	1	114910008
11491	38	50	100	55,50	1	114910010
11491	38	50	120	55,50	1	114910012
11491	38	50	150	55,50	1	114910015
11491	38	50	180	55,50	1	114910018
11491	38	50	220	55,50	1	114910022
11491	38	50	240	55,50	1	114910024
11491	38	50	320	55,50	1	114910032
11491	38	50	400	55,50	1	114910040

	H mm	L m	P	€		
11493	50	50	40	94,00	1	114930004
11493	50	50	60	85,50	1	114930006
11493	50	50	80	84,00	1	114930008
11493	50	50	100	79,50	1	114930010
11493	50	50	120	79,50	1	114930012
11493	50	50	150	79,50	1	114930015
11493	50	50	180	79,50	1	114930018
11493	50	50	220	79,50	1	114930022
11493	50	50	240	79,50	1	114930024
11493	50	50	320	79,50	1	114930032
11493	50	50	400	79,50	1	114930040

	H mm	L m	P	€		
11495	120	25	40	111,00	1	114950004
11495	120	25	60	108,00	1	114950006
11495	120	25	80	105,00	1	114950008
11495	120	25	100	102,00	1	114950010
11495	120	25	120	102,00	1	114950012
11495	120	25	180	102,00	1	114950018
11495	120	25	240	102,00	1	114950024
11495	120	25	400	102,00	1	114950040

11498

rolo antidesperdício em tecido não tecido
fibras sintéticas de coríndon

h 100 mm x 10 m



	H mm	L m	P	€		
11498	100	10	M	49,00	1	114980008
11498	100	10	F	40,00	1	114980012
11498	100	10	VF	40,00	1	114980015
* 11498	100	10	UF	43,00	1	114980018



ALICATES PARA CRAVAGEM DE TERMINAIS

		Terminais	Cavidade do molde	Range (mm ²)	Utilização
1601/PC					Para terminais telefônicos e de transmissão de dados 4P/6P/8P
1602				0,75-6	Para terminais isolados, série light
1602A				0-6	Para terminais isolados, modelo standard
1603				1,25-5,5	Para terminais não isolados, série light
1603A				0-8	Para terminais não isolados, modelo standard
1603B				0-8	Para terminais abertos não isolados, modelo standard
1606/2				0,14-10	Para trabalhos pesados, terminais cilíndricos
1606A				0,5-6 6-16	Para terminais cilíndricos
1606T				0,1-10	Para terminais cilíndricos, cravagem em 4 lados
1607				6,48 5,41 1,69	Para trabalhos pesados, para cabos coaxiais BNC RG 58, RG 59, RG 62, RG 71
1608				0,5-6	Para terminais isolados, com regulador de pressão
1608A				0,75-6	Para trabalhos pesados, terminais isolados
1609				0,5-2,5	Para terminais não isolados
1609A				0,5-6	Para trabalhos pesados, terminais não isolados
1609B				10-120	Para terminais não isolados

1601/PC

alicate para cravar terminais de cabos de telefone e de transmissão de dados



RJ11-RJ12-RJ45

€ 71,00 2 016010011

1602

alicate para cravar terminais isolados série ligeira

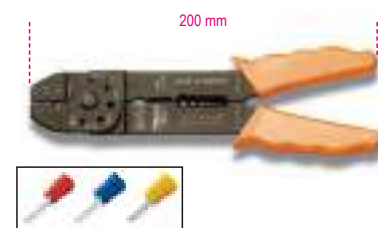

mm²
0,75+6

€ 17,70 5 016020001

1602/C9

alicate para cravar terminais isolados série ligeira com jogo de 450 terminais diversos



1602/C9

€ 153,00 1 016020045

1602

BM00180	R/6,3	50
BM00280	B/6,3	50
BM00380	G/6,3	50
BM00191	R/6,3	50
BM00291	B/6,3	50
BM00392	G/6,3	50
BM00160	R/1,6	50
BM00260	B/2,3	50
BM00360	G/3,6	50

420x185x60 mm - 1,5 kg

1602A

alicate para cravar terminais isolados modelo standard



mm²
0÷6 € 65,00 2 016020005

1603

alicate para cravar terminais não isolados série ligeira

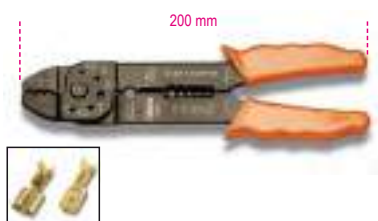

mm²
1,25÷5,5 € 17,70 5 016030001

1603A

alicate para cravar terminais não isolados fechados modelo standard

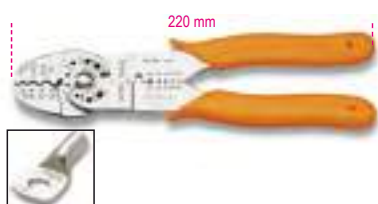

mm²
0÷8 € 65,00 2 016030005

1603B

alicate para cravar terminais não isolados abertos modelo standard

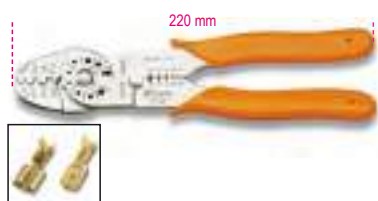

mm²
0÷8 € 66,50 2 016030010



1606/2

alicates de cravar terminais cilindricos para serviços pesados



mm²
0,14÷10 L mm 175 A mm 65 B mm 20 € 387,00 1 016060002

1606A

alicate de cravar terminais tubulares



mm²
1606A6 0,5÷6 € 104,00 1 016060010
1606A16 6÷16 € 104,00 1 016060016

1606A/C9

alicate de cravar para terminais tubulares com jogo de 450 terminais, 0,5÷6 mm²



1606A/C9 € 170,00 1 016060045

1606A6	n.
BM00601 W/0,5	50
BM00604 N/1,5	100
BM00506 B/2,5	100
BM00508 G/4	100
BM00610 Y/6	100

420x185x60 mm - 2,5 kg



Beta

1606T

alicate de cravar terminais tubulares, cravagem em 4 lados

reduzida tensão da alavanca



mm²
0.1÷10 L mm 173 A mm 61 B mm 13 € 346,00 1 016060005

1607

alicates para cravar terminais de cabo coaxial BNC RG 58, RG 59, RG 62, RG 71



1607 L mm 220 A mm 73 B mm 19 € 341,00 1 016070001

1608

alicate para cravar terminais isolados, com regulador de pressão



mm²
0,5÷6 € 133,00 1 016080001

1608/C9

alicate de pressão com jogo de 450 terminais diversos



1608/C9 € 268,00 1 016080045

1608	n.
BM00180 R/6,3	50
BM00280 B/6,3	50
BM00380 G/6,3	50
BM00191 R/6,3	50
BM00291 B/6,3	50
BM00392 G/6,3	50
BM00160 R/1,6	50
BM00260 B/2,3	50
BM00360 G/3,6	50

420x185x60 mm - 2 kg

1608A

alicate para cravar terminais isolados, para serviço pesado



mm² 0,75÷6 € 269,00 1 016080005

Beta

1609

alicate para cravar terminais não isolados modelo profissional



mm² 0,5÷2,5 € 133,00 1 016090001

1609A

alicate para cravar terminais não isolados, para serviço pesado



mm² 0,5÷6 € 525,00 1 016090005

1609B

alicate de cravar terminais para terminais não isolados
matrizes, 10 mm² ÷ 120 mm²



L mm 600 mm² 10÷120 € 354,00 1 016090101

1609C/C5

alicate para cravar terminais hidráulico com 5 pares de matrizes

matrizes hexagonais, 25 mm² ÷ 240 mm²



mm² 50÷240 € 2.270,00 1 016090210
500x300x110 mm - 4 kg

1609M

matrizes para artigo 1609C

matrizes hexagonais



	mm ²	€		
1609M/16	10-16	82,00	1	016090221
1609M/35	25-35	82,00	1	016090223
1609M/70	50-70	82,00	1	016090225
1609M/120	95-120	82,00	1	016090227
1609M/150	150	82,00	1	016090229
1609M/185	185	82,00	1	016090231
1609M/240	240	82,00	1	016090233

1639S

extractor fios de nylon

com cabeças intercambiáveis



L m 10 Ø mm 4 € 24,10 1 016390010





PRODUTOS DA MARCA BM: TERMINAIS, ABRAÇADEIRAS, BLOCOS DE TERMINAIS, FITAS ISOLADORAS

O Grupo BM concebe, fabrica e distribui peças de ligação e produtos de instalação elétrica desde 1958. Qualidade, segurança e fiabilidade sempre foram os principais valores da BM. Combinados com a paixão pela excelência, estes valores permitiram que a empresa se tornasse numa referência para o mercado de materiais elétricos. Em 2018, o Grupo BM foi integrado pela Beta Utensili. Esta seção inclui uma seleção de produtos da marca BM, complementando a linha de produtos Beta.

QUALIDADE CERTIFICADA



1610-B

terminais pré-isolados com olhais



D mm	mm²	L mm	€	unidades	BM
4	0,25-1,5	20,6	9,30	100	BM00119
5	0,25-1,5	21,8	9,20	100	BM00125
5	1,5-2,5	22,4	9,40	100	BM00225
6	1,5-2,5	26	10,50	100	BM00231
8	1,5-2,5	29,8	12,50	100	BM00237
6	4-6	29,1	16,40	50	BM00331
8	4-6	34,5	20,20	50	BM00337

indicar no pedido o número de terminais e não de embalagens

-os preços indicados são relativos a 100 unidades

1614-P

terminais pré-isolados com ponta



D mm	mm²	L mm	€	unidades	BM
1,9	0,25-1,5	19	9,30	100	BM00151
1,9	1,5-2,5	19	9,80	100	BM00251
2,7	4-6	28	16,20	50	BM00350

indicar no pedido o número de terminais e não de embalagens

-os preços indicados são relativos a 100 unidades

1616-SM

terminais pré-isolados tipo pino macho



D mm	mm²	L mm	€	unidades	BM
4	0,25-1,5	21	18,30	100	BM00130

indicar no pedido o número de terminais e não de embalagens

-os preços indicados são relativos a 100 unidades

1618-SF

terminais pré-isolados tipo pino fêmea



D mm	mm²	L mm	€	unidades	BM
3,8	0,25-1,5	23,5	21,20	100	BM00140

indicar no pedido o número de terminais e não de embalagens

-os preços indicados são relativos a 100 unidades

1620-M

terminais pré-isolados rápidos macho

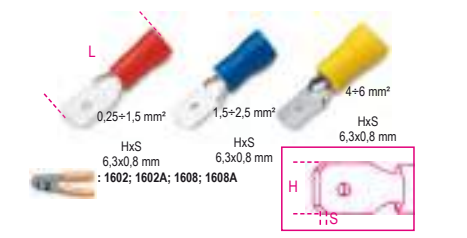

HxS mm	mm²	L mm	€	unidades	BM
6,3x0,8	0,25-1,5	21	17,60	100	BM00180
6,3x0,8	1,5-2,5	21	18,30	100	BM00280
6,3x0,8	4-6	24,5	20,00	50	BM00380

indicar no pedido o número de terminais e não de embalagens

-os preços indicados são relativos a 100 unidades

1622-F

terminais pré-isolados rápidos fêmea



HxS mm	mm²	L mm	€	unidades	BM
6,3x0,8	0,25-1,5	20,7	17,90	100	BM00190
2,8x0,5	0,25-1,5	18,5	15,10	100	BM00395
6,3x0,8	1,5-2,5	20,7	18,30	100	BM00290
6,3x0,8	4-6	24,5	26,00	50	BM00391

indicar no pedido o número de terminais e não de embalagens

-os preços indicados são relativos a 100 unidades

1624-FI

terminais rápidos fêmea isolados



HxS mm	mm²	L mm	€	unidades	BM
6,3x0,8	0,25-1,5	22	19,80	100	BM00191
6,3x0,8	1,5-2,5	22	20,10	50	BM00291
6,3x0,8	4-6	25	25,00	50	BM00392

indicar no pedido o número de terminais e não de embalagens

-os preços indicados são relativos a 100 unidades

1628-C

conectores de linha pré-isolados

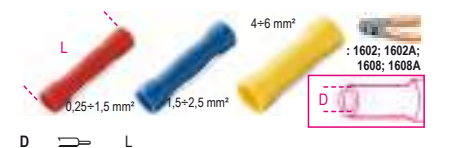

D mm	mm²	L mm	€	unidades	BM
1,8	0,25-1,5	25	14,90	100	BM00160
2,5	1,5-2,5	26,5	17,60	100	BM00260
3,7	4-6	27	24,40	50	BM00360

indicar no pedido o número de terminais e não de embalagens

-os preços indicados são relativos a 100 unidades

1630-CR

conectores rápidos



mm²	L mm	€	unidades	BM
0,25-1	15,3	15,40	500	BM00110
1,25-2,5	15,9	15,00	500	BM00210

indicar no pedido o número de terminais e não de embalagens

-os preços indicados são relativos a 100 unidades

1632-TS

terminais tipo tubo simples



mm²	L mm	€	unidades	BM
0,5	14	1,83	500	BM00601
0,75	14	1,83	500	BM00602
1	14	1,83	500	BM00603
1,5	14	1,83	500	BM00604
2,5	14	2,39	250	BM00506
4	17	3,80	200	BM00508
6	20	6,20	100	BM00610
0,5	14	1,75	500	BM00501
0,75	14	1,75	500	BM00502
1	14	1,75	500	BM00503
1,5	14	1,74	500	BM00504
6	20	5,90	100	BM00510

indicar no pedido o número de terminais e não de embalagens

-os preços indicados são relativos a 100 unidades

1634-TD

terminais tipo tubo duplos



mm²	L mm	€	unidades	BM
2x0,5	15	6,10	200	BM00651
2x0,75	15	4,70	200	BM00652
2x1	15	4,70	200	BM00654
2x1,5	16	5,10	200	BM00656
2x2,5	18,5	5,80	100	BM00558
2x4	23	17,10	100	BM00560
2x6	26	22,30	50	BM00661
2X0,5	15	4,50	200	BM00551
2X0,75	15	4,50	200	BM00552
2X1	15	4,50	200	BM00554
2X1,5	16	4,80	200	BM00556
2X6	26	21,20	50	BM00561

indicar no pedido o número de terminais e não de embalagens

-os preços indicados são relativos a 100 unidades

Beta
QUALITY TOOLS



1635-D

terminais de polipropileno, réguas de 12 polos

Corpo isolante: polipropileno natural (PP)

Corpo condutor: latão

Parafuso imperdível: aço zincado

Auto-extinção: EN 60335-1: 2002+A2:2006 (par. 30.2.3), EN 60695-2-10 a 850 °C, EN 60695-2-11

Temperatura de funcionamento: máx. 85°C

Grau de proteção: IP20

Normas de referência: EN 60998-1: 2004, EN 60998-2-1: 2004, EN 60335-1: 2002 + A2: 2006 (par. 30.2.3), IEC/EN 60695-2-11



mm ²	L mm	L1 mm	mm ²	N	€	100 unid.	BM
16	93,7	14,7	2,5	2	1,55	50	BM9200
20,5	116,5	17,2	4	2	1,92	50	BM9201
23,5	139,5	20,1	6	2	2,81	50	BM9202
25,3	175,5	22,5	16	2	4,95	25	BM9203
35,2	228	33,5	25	2	13,70	10	BM9204

1635-S

cerra-cabos terminais para ligações avulsas

Corpo isolante: policarbonato transparente UL94 V0

Corpo condutor: latão

Parafuso imperdível: aço zincado

Auto-extinção: EN60695-2-10 a 850 °C, EN 60335-1:2002 +A2:2006, EN60695-2-11

Temperatura de operação: max 85 °C

Grau de proteção: IP20

Normas de referência: EN60998-1: EN60998-2-1:2004



mm ²	L mm	L1 mm	S mm	mm ²	N	€	100 unid.	BM
1.5	15	7.5	14.5	1.5	2	1,40	10	BM991
					1 2+3			
					0.75 2+4			
2.5	17.5	9	18.2	2.5	2	1,43	10	BM992
					1.5 2+3			
					1 2+4			
4	21	10.3	20	4	2	1,92	10	BM9924
					2.5 2+3			
					1.5 2+4			
6	22.5	11.8	23	6	2	2,24	10	BM993
					4 2+3			
					2.5 2+4			
10	26	14.7	26	10	2	3,80	10	BM994
					6 2+3			
					4 2+4			
16	31.8	18.8	32.2	16	2	9,10	10	BM995
					10 2+3			
					6 2+4			

1635-S



mm ²	L mm	L1 mm	S mm	mm ²	N	€	100 unid.	BM
25	36.3	22.5	41.9	25	2	4,20	25	BM9960
					16 2+3			
					10 2+4			
35	43.5	26.1	49.4	35	2	5,40	25	BM9961
					25 2+3			
					16 2+4			



1748-BV2

abraceadeiras em nylon, cor natural

Material: Poliamida PA 6.6

Classe de auto-extinção: UL 94-V2

Temperatura de operação: -40 °C + +85 °C

Temperatura mínima de instalação: -10 °C

Resistência aos agentes químicos: Boa resistência às bases, aos óleos, às massas, aos solventes de cloreto. Limitada resistência aos ácidos. Não resistente aos fenóis

Normas de referência: EN 62275:2015-02

Classificação: tipo 1 (EN); tipo 21 (UL)



A mm	L mm	Ø MAX mm	F MAX N	€	100 unid.	BM
2.5	80	14	80	1,53	100	BMB0824
2.5	100	20.5	80	1,42	100	BMB1025
2.5	120	27	80	2,50	100	BMB1225
2.5	160	40	80	3,35	100	BMB1625
2.5	200	52.5	80	3,70	100	BMB2025
3.6	140	33	180	3,80	100	BMB1436
3.6	200	52.5	180	5,30	100	BMB2036
3.6	300	106	180	7,40	100	BMB2936
3.6	370	105	180	11,70	100	BMB3736
4.6	120	24	220	5,20	100	BMB1248
4.6	160	36	220	5,50	100	BMB1648
4.8	188	46	220	6,60	100	BMB1948
4.8	200	50	220	6,50	100	BMB2048
4.8	250	65	220	9,40	100	BMB2548
4.8	300	81	220	9,60	100	BMB3048
4.8	370	103.5	220	12,10	100	BMB3748
4.8	390	110	220	16,50	100	BMB3948
4.8	430	122.5	220	21,30	100	BMB4348
4.8	530	160	220	35,50	100	BMB5348
7.6	150	24	550	17,60	100	BMB1576
7.6	200	51	550	18,10	100	BMB2076
7.6	300	83	550	20,20	100	BMB2976
7.6	370	103.5	550	24,50	100	BMB3776
7.6	450	130.5	550	41,50	100	BMB4576
7.6	540	159	550	53,50	100	BMB5476
7.6	750	226	550	85,50	100	BMB7576
8.8	550	163.5	800	50,50	100	BMB5390
8.8	710	195	800	71,00	100	BMB7190
8.8	780	235.5	800	79,50	100	BMB7890
9.0	430	130.5	800	42,00	100	BMB4390
9.0	810	245	800	94,50	100	BMB8190
9.0	1020	295	800	130,00	100	BMB1090
9.0	1220	375.5	800	169,00	100	BMB1290
9.0	1530	460	800	230,00	100	BMB1590

indicar no pedido o número de terminais e não de embalagens

-os preços indicados são relativos a 100 unidades



1748V

abraceadeiras em nylon, cor verde

Material: poliamida PA 6.6

Classe de auto-extinção: UL 94-V2

Temperatura de funcionamento: -40 °C + +85 °C

Temperatura mínima de instalação: -10 °C

Resistência a produtos químicos: boa resistência a bases, óleos, graxas, solventes de cloreto. Resistência limitada a ácidos. Não resistente a fenóis.

Normas de referência: EN 62275:2015-02

Classificação: tipo 1 (EN); tipo 21 (UL)



A mm	L mm	Ø MAX mm	F MAX N	€	100 unid.	BM
2.5	100	20.5	80	1,40	100	BMV1025
3.6	140	33	180	3,45	100	BMV1436
4.8	200	50	220	5,90	100	BMV2048
4.8	300	81	220	8,70	100	BMV3048

- Por favor, indique o número de abraçadeiras, e não de embalagens no seu pedido.

- Os preços indicados são para 100 unid.

1748N

abraceadeiras em nylon, cor preta resistente a UV

Material: Poliamida PA 6.6 + carbon black

Classe de auto-extinção: UL 94-V2

Temperatura de operação: -40 °C + +85 °C

Temperatura mínima de instalação: -10 °C

Resistência aos agentes químicos: Boa resistência às bases, aos óleos, às massas, aos solventes de cloreto. Limitada resistência aos ácidos. Não resistente aos fenóis

Normas de referência: EN 62275:2015-02

Classificação: tipo 1 (EN)



A mm	L mm	Ø mm	F MAX N	€	100 unid.	BM
2.5	80	14	80	1,53	100	BMN0824
2.5	100	20.5	80	1,42	100	BMN1025
2.5	120	27	80	2,53	100	BMN1225
2.5	160	40	80	3,35	100	BMN1625
2.5	200	52.5	80	3,70	100	BMN2025
3.6	140	33	180	3,80	100	BMN1436
3.6	200	52.5	180	5,30	100	BMN2036
3.6	300	106	180	7,40	100	BMN2936
3.6	370	105	180	11,90	100	BMN3736
4.6	120	24	220	5,20	100	BMN1248
4.6	160	36	220	5,60	100	BMN1648
4.8	188	46	220	6,60	100	BMN1948
4.8	200	50	220	6,50	100	BMN2048
4.8	250	65	220	9,40	100	BMN2548
4.8	300	81	220	9,60	100	BMN3048
4.8	370	103.5	220	12,10	100	BMN3748
4.8	390	110	220	16,50	100	BMN3948
4.8	430	122.5	220	21,30	100	BMN4348
4.8	530	160	220	35,50	100	BMN5348
7.6	150	24	550	17,60	100	BMN1576
7.6	200	51	550	18,10	100	BMN2076
7.6	300	83	550	20,20	100	BMN2976
7.6	370	103.5	550	24,00	100	BMN3776
7.6	450	130.5	550	41,50	100	BMN4576
7.6	540	159	550	53,50	100	BMN5476
7.6	750	226	550	85,50	100	BMN7576
8.8	550	163.5	800	50,50	100	BMN5390
8.8	710	195	800	71,00	100	BMN7190
8.8	780	235.5	800	79,50	100	BMN7890
9.0	430	130.5	800	42,00	100	BMN4390
9.0	810	245	800	94,00	100	BMN8190
9.0	1020	295	800	131,00	100	BMN1090
9.0	1220	375.5	800	169,00	100	BMN1290
9.0	1530	460	800	230,00	100	BMN1590

indicar no pedido o número de terminais e não de embalagens

-os preços indicados são relativos a 100 unidades

1748-UL

abraçadeiras em nylon,
cor preta
resistente a UV

CE

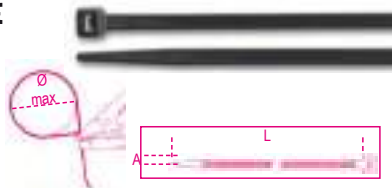

A	L	Ø MAX	F MAX	€		
mm	mm	mm	N			
12.4	230	57	1200	52,00	100	BMN2412
12.4	480	136.5	1200	89,50	100	BMN4912
12.4	730	216.1	1200	125,00	100	BMN7412
12.4	880	263.9	1200	149,00	100	BMN8912
12.4	1000	305	1200	178,00	100	BMN1012

1748-N2D

abraçadeiras em nylon,
cor preta
resistente a UV

Material: poliamida PA 6.6 + carbon black
Classe de auto-extinção: UL 94-V2
Temperatura de operação: -40 °C ÷ +85 °C
Temperatura mínima de instalação: -10 °C
Resistência aos agentes químicos: Boa resistência às bases, aos óleos, às massas, aos solventes de cloreto. Limitada resistência aos ácidos. Não resistente aos fenóis
Normas de referência: EN 62275:2015-02
Classificação: tipo 1 (EN)

CE



A	L	Ø MAX	F MAX	€		
mm	mm	mm	N			
9.0	180	40	400	27,00	100	BMN1890
9.0	265	62	540	42,00	100	BMN2690
9.0	360	93	540	51,00	100	BMN3690

- No pedido indicar o número de abraçadeiras e não de embalagens
- Os valores indicados são para 100 unidades

1748-BV0

abraçadeiras em nylon auto-extinguente,
cor branca

Material: Poliamida PA 6.6
Classe de auto-extinção: UL 94-V0
Temperatura de operação: -40 °C ÷ +8 °C
Temperatura mínima de instalação: -10 °C
Resistência aos agentes químicos: Boa resistência às bases, aos óleos, às massas, aos solventes de cloreto. Limitada resistência aos ácidos. Não resistente aos fenóis
Normas de referência: EN 62275:2015-02
Classificação: tipo 1 (EN)

CE V0



A	L	Ø MAX	F MAX	€		
mm	mm	mm	N			
2.5	100	20.5	80	2,23	100	BMB1025V0
3.6	150	36.0	180	5,40	100	BMB1536V0
3.6	200	52.5	180	7,80	100	BMB2036V0
4.8	200	49.5	230	8,50	100	BMB2048V0
4.8	300	81.0	230	12,40	100	BMB3048V0
4.8	370	106.7	230	17,70	100	BMB3848V0
7.6	370	106.7	540	31,00	100	BMB3876V0

indicar no pedido o número de terminais e não de embalagens

-os preços indicados são relativos a 100 unidades

1748-BX

abraçadeiras em nylon,
cor azul,
detectável por detector de metais

Material: Poliamida PA 6.6 + pó metálico
Classe de auto-extinção: UL 94-V2
Temperatura de operação: -40 °C ÷ +85 °C
Temperatura mínima de instalação: -10 °C
Resistência aos agentes químicos: Boa resistência às bases, aos óleos, às massas, aos solventes de cloreto. Limitada resistência aos ácidos. Não resistente aos fenóis
Normas de referência: EN 62275:2015-02
Classificação: tipo 1 (EN)

CE



A	L	Ø MAX	F MAX	€		
mm	mm	mm	N			
2.5	100	20.5	80	2,68	100	BMBX1025
3.6	150	36.0	180	7,10	100	BMBX1536
3.6	200	52.5	180	9,50	100	BMBX2036
4.8	200	49.5	230	11,60	100	BMBX2048
4.8	300	81.0	230	16,80	100	BMBX3048
4.8	370	106.7	230	22,80	100	BMBX3848
7.6	370	106.7	540	41,50	100	BMBX3876

1748-BL

abraçadeiras em nylon com dente em aço,
cor natural

Material: Poliamida PA 6.6 + aço
Classe de auto-extinção: UL 94-V2
Temperatura de operação: -40 °C ÷ +85 °C
Temperatura mínima de instalação: -10 °C
Resistência aos agentes químicos: Boa resistência às bases, aos óleos, às massas, aos solventes de cloreto. Limitada resistência aos ácidos. Não resistente aos fenóis
Normas de referência: EN 62275:2015-02
Classificação: tipo 1 (EN)

CE

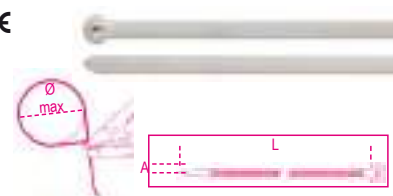

A	L	Ø MAX	F MAX	€		
mm	mm	mm	N			
2.5	100	20.5	180	5,40	100	BMBL1025
2.5	200	52.5	180	7,00	100	BMBL2025
3.6	140	33.0	250	12,00	100	BMBL1436
4.8	200	49.5	360	16,70	100	BMBL2048
4.8	300	81.0	360	21,40	100	BMBL3048
4.8	370	103.5	360	25,50	100	BMBL3748
7.6	370	103.5	780	48,50	100	BMBL3776

indicar no pedido o número de terminais e não de embalagens

-os preços indicados são relativos a 100 unidades

1748-NL

abraçadeiras em nylon com dente de aço,
cor preta,
resistente a UV

Material: Poliamida PA 6.6 + aço + carbon black
Classe de auto-extinção: UL 94-V2
Temperatura de operação: -40 °C ÷ +85 °C
Temperatura mínima de instalação: -10 °C
Resistência aos agentes químicos: Boa resistência às bases, aos óleos, às massas, aos solventes de cloreto. Limitada resistência aos ácidos. Não resistente aos fenóis
Normas de referência: EN 62275:2015-02
Classificação: tipo 1 (EN)

CE

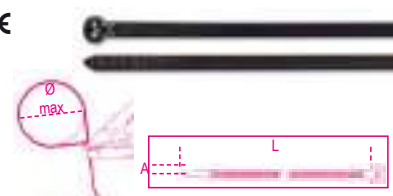

A	L	Ø MAX	F MAX	€		
mm	mm	mm	N			
2.5	100	20.5	180	5,40	100	BMNL1025
2.5	200	52.5	180	7,00	100	BMNL2025
3.6	140	33.0	250	12,00	100	BMNL1436
4.8	200	49.5	360	16,70	100	BMNL2048
4.8	300	81.0	360	21,40	100	BMNL3048
4.8	370	103.5	360	25,50	100	BMNL3748
7.6	370	103.5	780	47,50	100	BMNL3776

indicar no pedido o número de terminais e não de embalagens

-os preços indicados são relativos a 100 unidades

1748-BR

abraçadeiras em nylon reutilizáveis,
cor natural

Material: Poliamida PA 6.6
Classe de auto-extinção: UL 94-V2
Temperatura de operação: -40 °C + +85 °C
Temperatura mínima de instalação: -10 °C
Resistência aos agentes químicos: Boa resistência às bases, aos óleos, às massas, aos solventes de cloreto. Limitada resistência aos ácidos. Não resistente aos fenóis
Normas de referência: EN 62275:2015-02
Classificação: tipo 1 (EN); tipo 21 (UL)

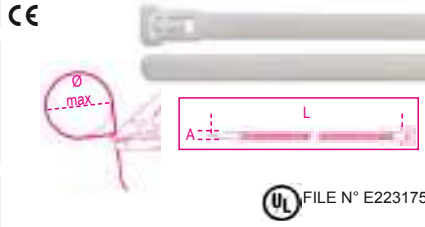

A	L	Ø MAX	F MAX	€	100	100
mm	mm	mm	N			
7.6	150	40	230	18,50	100	BMBR1576
7.6	200	55	230	19,80	100	BMBR2076
7.6	300	82	230	33,50	100	BMBR3076

1748-BH

abraçadeiras em nylon com olhal,
cor natural

Material: Poliamida PA 6.6
Classe de auto-extinção: UL 94-V2
Temperatura de operação: -40 °C + +85 °C
Temperatura mínima de instalação: -10 °C
Resistência aos agentes químicos: Boa resistência às bases, aos óleos, às massas, aos solventes de cloreto. Limitada resistência aos ácidos. Não resistente aos fenóis
Normas de referência: EN 62275:2015-02
Classificação: tipo 1 (EN); tipo 21 (UL)

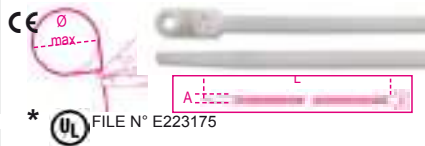

A	L	Ø MAX	F MAX	€	100	100
mm	mm	mm	N			
2.5	110	19.0	80	4,90	100	BMBH1125
* 4.8	200	49.8	230	12,10	100	BMBH2048
* 7.6	305	78.7	550	40,00	100	BMBH3076

1748-BP

abraçadeiras em nylon de inserção,
cor natural

Material: Poliamida PA 6.6
Classe de auto-extinção: UL 94-V2
Temperatura de operação: -40 °C + +85 °C
Temperatura mínima de instalação: -10 °C
Resistência aos agentes químicos: Boa resistência às bases, aos óleos, às massas, aos solventes de cloreto. Limitada resistência aos ácidos. Não resistente aos fenóis
Normas de referência: EN 62275:2015-02
Classificação: tipo 1 (EN); tipo 21 (UL)

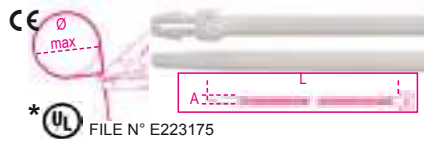

A	L	Ø MAX	F MAX	€	100	100
mm	mm	mm	N			
3.6	155	37.9	180	7,50	100	BMBP1536
* 4.8	200	50.8	230	13,00	100	BMBP2048

1748-BT

abraçadeiras em nylon com etiqueta
transversal 25x8mm,
cor natural

Material: Poliamida PA 6.6
Classe de auto-extinção: UL 94-V2
Temperatura de operação: -40 °C + +85 °C
Temperatura mínima de instalação: -10 °C
Resistência aos agentes químicos: Boa resistência às bases, aos óleos, às massas, aos solventes de cloreto. Limitada resistência aos ácidos. Não resistente aos fenóis
Normas de referência: EN 62275:2015-02
Classificação: tipo 1 (EN); tipo 21 (UL)

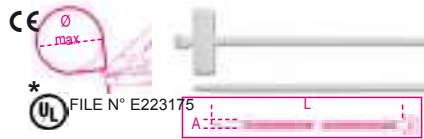

A	L	Ø MAX	F MAX	€	100	100
mm	mm	mm	N			
* 2.5	100	22.0	80	8,40	100	BMBT21025
2.5	200	53.5	80	13,20	100	BMBT22025

indicar no pedido o número de terminais e não de embalagens

-os preços indicados são relativos a 100 unidades

1748-BT2

abraçadeiras em nylon com etiqueta
longitudinal 13x27mm,
cor natural

Material: Poliamida PA 6.6
Classe de auto-extinção: UL 94-V2
Temperatura de operação: -40 °C + +85 °C
Temperatura mínima de instalação: -10 °C
Resistência aos agentes químicos: Boa resistência às bases, aos óleos, às massas, aos solventes de cloreto. Limitada resistência aos ácidos. Não resistente aos fenóis
Normas de referência: EN 62275:2015-02
Classificação: tipo 1 (EN)



A	L	Ø MAX	F MAX	€	100	100
mm	mm	mm	N			
4.8	190	51	230	15,60	100	BMBT12248

1748-BT3

abraçadeiras em nylon com etiqueta externa
20x9mm,
cor natural

Material: Poliamida PA 6.6
Classe de auto-extinção: UL 94-V2
Temperatura de operação: -40 °C + +85 °C
Temperatura mínima de instalação: -10 °C
Resistência aos agentes químicos: Boa resistência às bases, aos óleos, às massas, aos solventes de cloreto. Limitada resistência aos ácidos. Não resistente aos fenóis
Normas de referência: EN 62275:2015-02
Classificação: tipo 1 (EN)

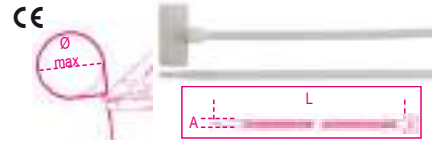

A	L	Ø MAX	F MAX	€	100	100
mm	mm	mm	N			
2.5	110	22	80	8,60	100	BMBT1125

indicar no pedido o número de terminais e não de embalagens

-os preços indicados são relativos a 100 unidades

1748-BA1

suportes de fixação

Material: Poliamida PA 6.6
Classe de auto-extinção: UL 94-V2
Temperatura de operação: -40 °C + +85 °C
Temperatura mínima de instalação: -10 °C
Resistência aos agentes químicos: Boa resistência às bases, aos óleos, às massas, aos solventes de cloreto. Resistência limitada aos ácidos. Não resistente aos fenóis



SxDxH	Ø	F	€	100	100
mm	mm	mm			
15.2x9.4x6.8	3.3	3.6	11,70	100	BMB0905
22x16.2x10.8	5.2	9	26,50	100	BMB0906

indicar no pedido o número de terminais e não de embalagens

-os preços indicados são relativos a 100 unidades

1748-NA1

suportes de fixação

Material: Poliamida PA 6.6
Classe de auto-extinção: UL 94-V2
Temperatura de operação: -40 °C + +85 °C
Temperatura mínima de instalação: -10 °C
Resistência aos agentes químicos: Boa resistência às bases, aos óleos, às massas, aos solventes de cloreto. Limitada resistência aos ácidos. Não resistente aos fenóis



SxDxH	Ø	F	€	100	100
mm	mm	mm			
15.2x9.4x6.8	3.3	3.6	12,00	100	BMN0905
22x16.2x10.8	5.2	9	21,40	100	BMN0906

indicar no pedido o número de terminais e não de embalagens

-os preços indicados são relativos a 100 unidades

Beta

1748-BA2

suportes de fixação bidirecionais

Material: Poliamida PA 6.6

Classe de auto-extinção: UL 94-V2

Temperatura de operação: -40 °C + +85 °C

Temperatura mínima de instalação: -10°C

Resistência aos agentes químicos: Boa resistência às bases, aos óleos, às massas, aos solventes de cloreto. Limitada resistência aos ácidos. Não resistente aos fenóis

CE



SxDxH mm	F mm	€	100	10
19x19x5.4	3.6	14,50	100	BMB0901
* 28x28x7	4.8	20,10	100	BMB0902
* 28x28x5.8	4.8	18,40	100	BMB0903

1748-NA2

suportes de fixação bidirecionais resistente a UV

Material: Poliamida PA 6.6

Classe de auto-extinção: UL 94-V2

Temperatura de operação: -40 °C + +85 °C

Temperatura mínima de instalação: -10 °C

Resistência aos agentes químicos: Boa resistência às bases, aos óleos, às massas, aos solventes de cloreto. Limitada resistência aos ácidos. Não resistente aos fenóis

CE

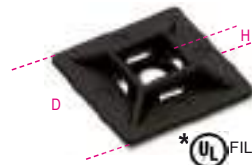

SxDxH mm	F mm	€	100	10
19x19x5.4	3.6	14,50	100	BMN0901
* 28x28x7	4.8	20,10	100	BMN0902
* 28x28x5.8	4.8	18,30	100	BMN0903

indicar no pedido o número de terminais e não de embalagens

-os preços indicados são relativos a 100 unidades



1748-S

abraçadeiras autobloqueantes em aço inoxidável

Material: aço inox AISI 304

Dispositivo de fixação: de esfera

Classe de auto-extinção: não inflamável

Plenum rating: AH-1

Resistência aos raios UV: excelente

Temperatura de operação: -60 °C + +300 °C

Temperatura mínima de instalação: -60 °C

Resistência aos agentes químicos: excelente

Normas de referência: EN 62275:2015-02

Classificação: tipo 2 (EN); tipo 2 (UL)

CE

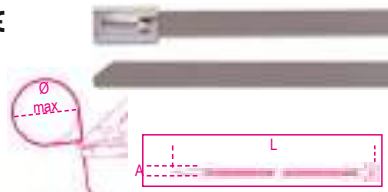

A mm	L mm	ØMAX mm	Trazione N	€	100	10
4.6	125	38	890	88,50	100	BMS1345
4.6	200	61.9	890	92,00	100	BMS2045
7.9	200	61.9	1500	97,50	100	BMS2079
4.6	290	90.6	890	99,00	100	BMS3045
7.9	300	90.6	1500	113,00	100	BMS3079
4.6	360	112.8	890	108,00	100	BMS3745
7.9	360	112.8	1500	123,00	100	BMS3779
7.9	500	163.8	1500	145,00	100	BMS5079
4.6	520	163.8	890	108,00	100	BMS5245
4.6	680	214.8	890	114,00	100	BMS6845
7.9	680	214.8	1500	166,00	100	BMS6879
4.6	840	265.7	890	120,00	100	BMS8445
7.9	840	265.7	1500	196,00	100	BMS8479

1748-SC

abraçadeiras autobloqueantes em aço inoxidável,

revestimento em poliéster preto

Material: aço inox AISI 304 + poliéster

Dispositivo de fixação: de esfera

Classe de auto-extinção: não inflamável

Plenum rating: AH-1

Resistência aos raios UV: excelente

Temperatura de operação: -60 °C + +300 °C

Temperatura mínima de instalação: -60 °C

Resistência aos agentes químicos: excelente

Normas de referência: EN 62275:2015-02

Classificação: tipo 2 (EN); tipo 2 (UL)

CE

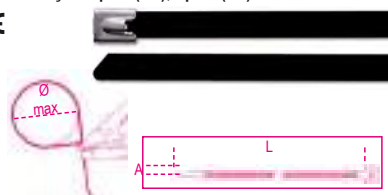

A mm	L mm	ØMAX mm	Trazione N	€	100	10
4.6	125	38	450	92,00	100	BMSC1345
4.6	200	61.9	450	107,00	100	BMSC2045
7.9	200	61.9	800	109,00	100	BMSC2079
4.6	290	90.6	450	120,00	100	BMSC3045
7.9	300	90.6	800	128,00	100	BMSC3079
4.6	360	112.8	450	132,00	100	BMSC3745
7.9	360	112.8	800	144,00	100	BMSC3779
7.9	520	163.8	800	181,00	100	BMSC5079
4.6	520	163.8	450	134,00	100	BMSC5245
4.6	680	214.8	450	153,00	100	BMSC6845
7.9	680	214.8	800	206,00	100	BMSC6879
4.6	840	265.7	450	162,00	100	BMSC8445
7.9	840	265.7	800	247,00	100	BMSC8479

1748-BV

abraçadeiras em Velcro, cor branca

Material: polietileno-poliamida (PE-PA)

Temperatura de funcionamento: -20 °C + +60 °C

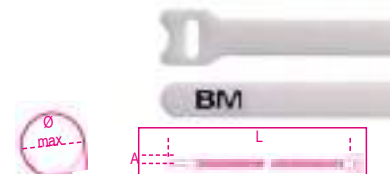

A mm	L mm	Ø MAX mm	F MAX N	€	10	10
12,7	229	55	180	259,00	10	BMBV2312
19	229	55	220	297,00	10	BMBV2319

- Por favor, indique o número de abraçadeiras, e não de embalagens no seu pedido.
- Os preços indicados são para 100 unid.

1748-NV

abraçadeiras em Velcro, cor preta

Material: polietileno-poliamida (PE-PA)

Temperatura de funcionamento: -20 °C + +60 °C



A mm	L mm	Ø MAX mm	F MAX N	€	10	10
12,7	229	55	180	259,00	10	BMNV2312

- Por favor, indique o número de abraçadeiras, e não de embalagens no seu pedido.
- Os preços indicados são para 100 unid.

1743

alicate para abraçadeiras em Nylon

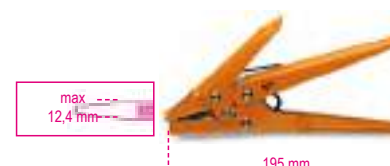

1743	€	100	1	017430001
	63,50			

1743T

Tesoura para abraçadeiras

• Também adequada para corte de pequenos cabos (3x1.5mm²; 1x17mm²)



1743T	€	100	1	017430100
	37,50			



1748-N

ferramentas de instalação para abraçadeiras em nylon, 2,5 a 4,8 mm de largura

Corte automático quando a tensão definida é atingida.
Com sistema de ajuste da tensão de aperto.

Materiais: estrutura em polímero e fibra de vidro, partes internas em metal



BM1100 € 70,50 1 BM1100

1748-ST

pinças automáticas para abraçadeiras em aço inoxidável, para abraçadeiras de 4,6 a 9 mm, com controlo automático da tensão e corte



BM1105 € 271,00 1 BM1105

1638M

revestimento termoretráctil fino, em mini caixa

Relação de retração: 2:1
Material: polietileno
Temperatura de funcionamento: -55 °C ÷ +125 °C
Temperatura de retração: +70 °C ÷ +125 °C
VRMS máximo: 600 V
Grau de auto-extinção: VW-1 (UL 224)
Sem halogénio



mm	L m	Ø1 mm	Ø2 mm	€	1	BMGBS016MNE
1,6	12	1,6	0,8	20,70	1	BMGBS016MNE
2,4	11	2,4	1,2	20,70	1	BMGBS024MNE
3,2	11	3,2	1,6	20,70	1	BMGBS032MNE
4,8	10	4,8	2,4	20,70	1	BMGBS048MNE
6,4	9	6,4	3,2	20,70	1	BMGBS064MNE
9,5	7	9,5	4,8	20,70	1	BMGBS095MNE
12,7	6	12,7	6,4	20,70	1	BMGBS127MNE
19	5	19,1	9,5	21,10	1	BMGBS190MNE
25,4	3,5	25,4	12,7	21,50	1	BMGBS254MNE

1639ESB

fita isolante em PVC

Temperatura de operação: 0-90 °C
Carga de ruptura: 28N/cm equivalente a 18.6 N/mm²
Alongamento em ruptura: 200%
Aderência ao aço: 2.2N/cm
Aderência ao dorso: 2 N/cm
Rigidez dielétrica: 45kV/mm
Inflamabilidade: retardante de chama
Normas de referência: IEC 60454-2
Classificação: CEI EN 60454-3-1-5/F-PVCP/90



S mm	A mm	L m	€	10	BMESB1510BI
0.15	15	10	0,94	10	BMESB1510BI
0.15	15	10	0,94	10	BMESB1510BL
0.15	15	10	0,94	10	BMESB1510GI
0.15	15	10	0,94	10	BMESB1510GR
0.15	15	10	1,05	10	BMESB1510GV
0.15	15	10	0,94	10	BMESB1510MA
0.15	15	10	0,94	10	BMESB1510NE
0.15	15	10	0,94	10	BMESB1510RO
0.15	15	10	0,94	10	BMESB1510VE
0.15	15	25	2,31	10	BMESB1525BI
0.15	15	25	2,31	10	BMESB1525BL
0.15	15	25	2,31	10	BMESB1525GI
0.15	15	25	2,31	10	BMESB1525GR
0.15	15	25	2,41	10	BMESB1525GV
0.15	15	25	2,31	10	BMESB1525MA
0.15	15	25	2,31	10	BMESB1525NE
0.15	15	25	2,31	10	BMESB1525RO
0.15	15	25	2,31	10	BMESB1525VE
0.15	19	25	2,52	10	BMESB1925BI
0.15	19	25	2,52	10	BMESB1925BL
0.15	19	25	2,52	10	BMESB1925GI
0.15	19	25	2,52	10	BMESB1925GR
0.15	19	25	2,62	10	BMESB1925GV
0.15	19	25	2,52	10	BMESB1925MA
0.15	19	25	2,52	10	BMESB1925NE
0.15	19	25	2,52	10	BMESB1925RO
0.15	19	25	2,52	10	BMESB1925VE
0.15	25	25	3,60	8	BMESB2525BI
0.15	25	25	3,60	8	BMESB2525BL
0.15	25	25	3,60	8	BMESB2525GI
0.15	25	25	3,60	8	BMESB2525GR
0.15	25	25	3,70	8	BMESB2525GV
0.15	25	25	3,60	8	BMESB2525MA
0.15	25	25	3,60	8	BMESB2525NE
0.15	25	25	3,60	8	BMESB2525RO
0.15	25	25	3,60	8	BMESB2525VE
0.15	50	25	5,50	4	BMESB5025NE

1639ESC

fita isolante em PVC

Temperatura de operação: 0-80 °C
Carga de ruptura: 28N/cm equivalente a 18.6 N/mm²
Alongamento em ruptura: 200%
Aderência ao aço: 2.2N/cm
Aderência ao dorso: 2.2 N/cm
Rigidez dielétrica: 38kV/mm
Inflamabilidade: retardante de chama
Normas de referência: ASTM-D-1000 ; UL510
Classificação: CEI EN 60454-3-1-5/F-PVCP/90



S mm	A mm	L m	€	10	BMESC1920NE
0.18	19	20	3,35	10	BMESC1920NE

1639ETA

fita isolante em PVC para altas temperaturas

Temperatura de operação: -18 ÷ +105 °C
Carga de ruptura: 35N/cm equivalente a 19.4 N/mm²
Alongamento em ruptura: 300%
Aderência ao aço: 3.1N/cm
Aderência ao dorso: 2.7 N/cm
Rigidez dielétrica: 55.5kV/mm
Inflamabilidade: retardante de chama
Normas de referência: ASTM-D-1000 ; UL510
Classificação: CEI EN 60454-3-1-5/F-PVCP/90



S mm	A mm	L m	€	1	BMETA1920NE
0.18	19	20	10,10	1	BMETA1920NE

1639EAB

fita isolante auto-aglomerante a base de EPR

Temperatura de operação: -40 ÷ +90 °C
Carga de ruptura: 2.4 N/mm²
Alongamento em ruptura: 750%
Rigidez dielétrica: 29.5kV/mm
Inflamabilidade: retardante de chama
Normas de referência: ASTM-D-4388; ASTM-D-4325
Resistência excelente a: humidade, corrosão e agentes químicos



S mm	A mm	L m	€	1	BMEAB1909NE
0.76	19	9	20,70	1	BMEAB1909NE



Beta
ULTRADW TOOLS



GAMA BLISTER

para a promoção
das suas vendas!

- **Maior visibilidade**
- **Código de barras**
- **Exposição eficiente**



PACK BLISTER:

- PVC à prova de rasgão
- 4 formatos para otimização do espaço de exposição
- Sistema de fixação de nova geração com banda elástica

42K



mm	€	🔧	📦
5,5x5,5	8,70	5	000429505
6x6	8,80	5	000429506
7x7	8,90	5	000429507
8x8	9,10	5	000429508
9x9	9,60	5	000429509
10x10	9,90	5	000429510
11x11	10,50	5	000429511
12x12	10,60	5	000429512
13x13	10,60	5	000429513
14x14	12,10	5	000429514
15x15	13,40	5	000429515
16x16	13,80	5	000429516
17x17	14,50	5	000429517
18x18	15,30	5	000429518
19x19	15,90	5	000429519
20x20	17,80	3	000429520
21x21	19,10	3	000429521
22x22	19,70	3	000429522
23x23	21,10	3	000429523
24x24	22,20	3	000429524
25x25	23,60	2	000429525
26x26	25,50	2	000429526
27x27	27,50	2	000429527
28x28	28,00	2	000429528
29x29	31,00	2	000429529
30x30	32,00	2	000429530
32x32	35,50	2	000429532

55K



mm	€	🔧	📦
6x7	5,30	5	000559012
8x9	5,40	5	000559021
10x11	5,60	5	000559030
10x12	7,60	5	000559033
10x13	8,30	5	000559035
12x13	6,30	5	000559042
12x14	8,50	5	000559045
13x17	9,90	5	000559051
14x15	7,90	5	000559054
14x17	10,70	5	000559057
16x17	9,00	5	000559060
17x19	11,90	2	000559063
18x19	10,50	2	000559066
19x22	13,50	2	000559069
20x22	11,90	2	000559075
21x23	12,60	2	000559078
22x24	14,60	2	000559081
24x26	15,00	2	000559087
24x27	16,30	2	000559090
25x28	17,10	2	000559096
27x29	19,10	2	000559099
27x30	22,00	2	000559102
30x32	21,20	2	000559108

90K



mm	€	🔧	📦
6x7	11,70	5	000909006
8x9	12,50	5	000909012
10x11	13,80	5	000909018
12x13	15,00	5	000909027
14x15	16,30	5	000909033
16x17	18,60	5	000909039
18x19	21,70	5	000909045

mm	€	🔧	📦
20x22	24,80	3	000909051
21x23	28,00	2	000909057
24x26	31,00	2	000909063
24x27	34,50	2	000909067
25x28	37,50	2	000909070
27x29	40,50	2	000909073
30x32	45,50	2	000909080

93K



mm	€	🔧	📦
21x22	47,00	3	000939021

94K



mm	€	🔧	📦
8x10	20,20	2	000949008
9x11	21,00	2	000949009
10x11	22,00	2	000949010
11x13	22,60	2	000949011
12x14	23,90	2	000949012
13x15	23,90	2	000949013
14x15	28,00	2	000949014
14x17	29,00	2	000949015
17x19	29,50	2	000949017
19x22	31,00	2	000949019
22x24	38,50	2	000949022
24x27	42,00	2	000949024
30x32	54,50	2	000949030

96/SC9



96/SC9	€	🔧	📦
1,5-2-2,5-3-4-5-6-8-10 mm	23,80	1	000960374

96/ST6K



96/ST6K	€	🔧	📦
2,5-3-4-5-6-8 mm	16,80	3	000969370

96N/ST6K



96N/ST6K	€	🔧	📦
2,5-3-4-5-6-8 mm	11,90	3	000969640

96BPA/SC9



96BPA/SC9	€	🔧	📦
1,5-2-2,5-3-4-5-6-8-10 mm	54,50	1	000961974

96BP-CL/SC9



96BP-CL/SC9	€	🔧	📦
1,5-2-2,5-3-4-5-6-8-10 mm	60,50	1	000961619

96BPC/SC9



96BPC/SC9	€	🔧	📦
1,5-2-2,5-3-4-5-6-8-10 mm	49,50	1	000960354

96C/AS



	€	🔧	📦
1/16	1,95	20	000961702
3/32	2,70	20	000961706
1/8	2,84	20	000961710
5/32	3,30	20	000961714
3/16	3,75	20	000961716
7/32	4,25	20	000961718
1/4	4,75	20	000961720
5/16	5,30	10	000961724
3/8	6,60	10	000961728

96LBP/SC9



96LBP/SC9 € 58,00 1 000961354
1,5-2-2,5-3-4-5-6-8-10 mm

96/BGS7



96/BGS7 € 35,50 1 000960367
1,5-2-2,5-3-4-5-6 mm

96/BG7



96/BG7 € 37,50 1 000960368
2,5-3-4-5-6-8-10 mm

96TK



mm	€	Hand	Code
2	13,80	5	000969934
2,5	13,80	5	000969935
3	14,40	5	000969936
4	14,90	5	000969938
5	15,20	5	000969940
6	17,40	5	000969941
8	22,00	3	000969943
10	25,00	3	000969945

97BTX/SC8



97BTX/SC8 € 89,00 1 000970164
T9-T10-T15-T20-T25-T27-T30-T40

97BTXL/SC8



97BTXL/SC8 € 103,00 1 000970364
T9-T10-T15-T20-T25-T27-T30-T40

111E



L mm	€	Hand	Code
100	28,50	3	001110110
150	29,50	3	001110115
200	36,00	3	001110120
250	43,50	3	001110125
300	58,00	3	001110130
380	114,00	3	001110138
450	189,00	2	001110145
600	262,00	1	001110160

111EN



L mm	€	Hand	Code
100	26,00	3	001110410
150	27,00	3	001110415
200	31,50	3	001110420
250	39,50	3	001110425
300	53,00	3	001110430
380	105,00	3	001110438
450	179,00	2	001110445

111ER



L mm	€	Hand	Code
200	37,50	3	001110520
250	46,50	3	001110525
300	60,50	2	001110530



123/K4



123/K4 € 37,50 1 001230504

142K



mm	€	Hand	Code
6	20,40	3	001429006
7	20,40	3	001429007
8	21,10	3	001429008
9	22,40	3	001429009
10	22,90	3	001429010
11	23,70	3	001429011
12	24,60	3	001429012
13	26,50	3	001429013
14	27,50	2	001429014
15	29,00	2	001429015
16	31,00	2	001429016
17	32,00	2	001429017
18	34,50	2	001429018
19	35,00	2	001429019
21	45,50	1	001429021
22	47,00	1	001429022
24	54,50	1	001429024

192/S2

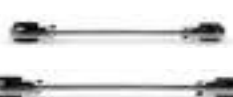

192/S2 € 73,50 1 001920070
8x10/12x13 mm
16x17/18x19 mm

195K



mm	€	Hand	Code
8x10	23,30	2	001959010
12x13	26,50	2	001959013
14x15	28,00	2	001959015
16x18	32,50	2	001959018
17x19	34,50	2	001959019

374K



374K € 41,50 1 003749024

850MQ



L mm	€	1	008500910
233	26,50		

855P



L1 mm	€	1	008550010
240	80,00		

860/58K



L mm	€	1	008609884
126	85,00		

860LP



SxA mm	€	5	008600005
0,5x3	2,08		
0,6x4,5	2,08		
0,8x5,5	2,08		
1x5,5	2,08		
1,2x6,5	2,08		

860PH



PH	€	5	008600220
0	2,08		
1	2,08		
2	2,08		
3	2,08		
4	3,00		

860PZ



PZ	€	5	008600320
1	2,08		
2	2,08		
3	2,08		
4	3,00		

860PE



mm	€	5	008600101
2	2,22		
2,5	2,22		
3	2,22		
4	2,22		
5	2,22		
6	2,22		
8	2,79		
10	2,79		

860TX



°	€	5	008600704
T6	2,79		
T7	2,79		
T8	2,79		
T9	2,79		
T10	2,22		
T15	2,22		
T20	2,22		
T25	2,22		
T27	2,22		
T30	2,22		
T40	2,22		

860RTX



°	€	5	008600550
T9	3,00		
T10	3,00		
T15	3,00		
T20	3,00		
T25	3,00		
T27	3,00		
T30	3,00		
T40	3,00		

860/C27



860/C27	€	1	008600880
	97,00		

860MIX/A10



860MIX/A10	€	1	008600900
	40,50		

860TX/A10



860TX/A10	€	1	008600970
	43,00		

860MIX/A31



860MIX/A31	€	1	008600902
	95,50		

862F/A7



862F/A7	€	1	008620950
	55,50		

900K



mm	€	10	009009040
4	4,85		
4,5	4,85		
5	4,85		
5,5	4,85		
6	4,85		
7	4,85		
8	4,85		
9	4,85		
10	4,85		
11	4,85		
12	4,85		
13	4,90		
14	5,10		

900/20LK

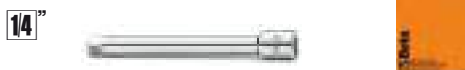

L mm	€	5	009009819
100	10,80		

900/25K

14"



L mm	€	🔧	📦
41	20,00	5	009009830

900BG/30K

14"



L mm	€	🔧	📦
128	10,50	5	009009834

900/55K

40%

14"



L mm	€	🔧	📦
125	53,50	5	009009870

900/55ZK

40%

14"



L mm	€	🔧	📦
125	53,50	3	009009882

900/58K

14"



L mm	€	🔧	📦
126	81,50	2	009009884

910AK

38"



mm	€	🔧	📦
6	7,60	5	009109006
7	7,60	5	009109007
8	7,60	5	009109008
9	7,60	5	009109009
10	7,60	5	009109010
11	7,60	5	009109011
12	7,80	5	009109012
13	7,80	5	009109013
14	7,80	5	009109014
15	7,80	5	009109015
16	8,80	5	009109016
17	8,80	5	009109017
18	8,80	5	009109018
19	8,80	5	009109019
20	9,40	5	009109020
21	9,40	5	009109021
22	9,60	5	009109022

910/21K

38"



L mm	€	🔧	📦
125	13,90	5	009109822

910/25K

38"



L mm	€	🔧	📦
54,6	24,70	5	009109830

910/55K

72%

38"



L mm	€	🔧	📦
200	58,00	3	009109882

910/58K

38"



L mm	€	🔧	📦
222	89,00	1	009109884

920AK

12"



mm	€	🔧	📦
10	6,30	10	009209010
11	6,30	10	009209011
12	6,30	10	009209012
13	6,60	10	009209013
14	6,60	10	009209014
15	6,60	10	009209015
16	7,30	10	009209016
17	7,30	10	009209017
18	7,30	10	009209018
19	7,30	10	009209019
20	8,00	5	009209020
21	8,00	5	009209021
22	8,00	5	009209022
23	9,30	5	009209023
24	9,30	5	009209024
25	9,30	5	009209025
26	9,60	5	009209026
27	9,60	5	009209027
28	9,60	5	009209028
29	9,90	5	009209029
30	9,90	5	009209030
32	10,40	5	009209032

920/21K

12"



L mm	€	🔧	📦
125	18,80	5	009209822

920/25K

12"



L mm	€	🔧	📦
75	29,50	5	009209830

920/55K

72%

12"



L mm	€	🔧	📦
275	70,50	3	009209882

920/58K

12"

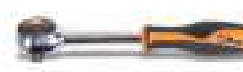

L mm	€	🔧	📦
281	106,00	1	009209926

935K



mm	€	🔧	📦
6x7	9,50	5	009359105
8x9	10,20	5	009359111
10x11	11,40	5	009359115
12x13	12,60	5	009359117
14x15	14,70	5	009359126
16x17	16,00	5	009359128
18x19	18,80	5	009359131
20x22	22,60	3	009359138

937K



mm	€	🔧	📦
6x6	10,20	5	009379006
7x7	10,60	5	009379007
8x8	11,10	5	009379008
9x9	11,70	5	009379009
10x10	12,00	5	009379010
11x11	12,60	5	009379011
12x12	14,10	5	009379012
13x13	14,40	5	009379013
14x14	15,70	5	009379014
15x15	17,40	5	009379015
16x16	18,70	5	009379016
17x17	19,50	5	009379017
18x18	19,90	5	009379018
19x19	20,70	5	009379019
20x20	23,20	5	009379020
21x21	25,50	3	009379021
22x22	26,50	3	009379022

943BK



mm	€	🔧	📄
5,5	19,90	5	009439005
6	19,90	5	009439006
7	21,20	5	009439007
8	21,20	5	009439008
10	22,90	3	009439010
13	24,50	3	009439013

951K



mm	€	🔧	📄
2	22,00	5	009519521
2,5	22,00	5	009519525
3	22,00	5	009519530
3,5	22,60	5	009519535
4	22,60	5	009519540
4,5	24,80	5	009519545
5	24,80	5	009519550
6	28,50	5	009519560
8	30,50	5	009519580
10	38,50	5	009519610

1032K



L mm	€	🔧	📄
140x0,9	28,00	5	010329013
140x1,3	27,50	5	010329014
180	29,50	5	010329017

1033K



L mm	€	🔧	📄
140x0,9	31,50	5	010339013
140x1,3	30,50	5	010339014
180	32,00	5	010339017

1034K



L mm	€	🔧	📄
130x0,9	31,50	5	010349013
130x1,3	30,50	5	010349014
170	32,00	5	010349017

1036K



L mm	€	🔧	📄
140x0,9	30,00	5	010369013
140x1,3	29,50	5	010369014
175	30,50	5	010369017

1037K



L mm	€	🔧	📄
140x0,9	33,50	5	010379013
140x1,3	32,00	5	010379014
175	33,50	5	010379017

1038K



L mm	€	🔧	📄
135x0,9	33,50	5	010389013
135x1,3	32,00	5	010389014
175	33,50	5	010389017

1044NK



L mm	€	🔧	📄
250	28,00	5	010449025

1048NK



L mm	€	🔧	📄
175	30,00	3	010489910
250	31,50	5	010489915

1048VNK



L mm	€	🔧	📄
175	29,50	3	010489111
250	33,50	5	010489116

1052K



L mm	€	🔧	📄
140	30,00	3	010529014
190	33,50	3	010529019
240	37,00	3	010529024

1082K



L mm	€	🔧	📄
140	29,00	5	010829004
160	30,00	5	010829006

1082GK



L mm	€	🔧	📄
140	24,90	5	010829064
160	26,00	5	010829066

1082BMK



L mm	€	🔧	📄
140	36,00	3	010829034
160	39,50	3	010829036

1082GBMK



L mm	€	🔧	📄
140	31,50	3	010829264
160	35,50	3	010829266

1084K



L mm	€	🔧	📄
160	33,50	3	010849006

1084GK



L mm	€		
160	29,50	5	010849066

1084BMK



L mm	€		
160	41,00	3	010849036

1084GBMK



L mm	€		
160	45,00	3	010849266

1088K



L mm	€		
160	41,50	2	010889006

1088BMK



L mm	€		
160	51,00	2	010889036

1096K



L mm	€		
200	26,00	5	010969020

1098K



L mm	€		
190	22,30	5	010989190
220	25,00	5	010989220

1098PLK



L mm	€		
220	28,00	5	010989320

1112K



L mm	€		
200	29,50	2	011129020

1122K



L mm	€		
250	40,00	2	011229020

1123K



L mm	€		
250	40,00	2	011239020

1124K



L mm	€		
250	40,00	2	011249020

1128BAX



L mm	€		
150	37,00	5	011280088

1128BMX



L mm	€		
147	19,60	5	011280051

1128BSX



L mm	€		
148	33,50	5	011280061

1128FX



L mm	€		
145	35,50	5	011280090

1128FXS



L mm	€		
145	42,50	5	011280095

1129BMK



L mm	€		
145	19,10	5	011299000

1130BMX



L mm	€	🔧	📄
185	22,00	1	011300002

1132K



L mm	€	🔧	📄
170	56,50	2	011329107

1132BMK



L mm	€	🔧	📄
170	69,50	2	011329137

1142BMK



L mm	€	🔧	📄
160	45,50	3	011429036

1144T



L mm	€	🔧	📄
112	23,30	1	011440060

1149F



L mm	€	🔧	📄
175	19,30	1	011490010

1150K



L mm	€	🔧	📄
160	25,50	5	011509046
180	28,00	5	011509048
200	30,00	5	011509050
220	33,00	2	011509052

1150GK



L mm	€	🔧	📄
160	23,90	5	011509066
180	26,00	5	011509068
200	29,00	5	011509070
220	30,00	2	011509072

1150BMK



L mm	€	🔧	📄
160	31,50	3	011509146
180	35,00	3	011509148
200	38,50	3	011509150
220	41,00	2	011509152

1150GBMK



L mm	€	🔧	📄
160	29,50	3	011509266
180	31,50	3	011509268
200	36,00	3	011509270
220	38,50	2	011509272

1162K



L mm	€	🔧	📄
160	30,00	5	011629006
200	35,00	5	011629010

1162GK



L mm	€	🔧	📄
160	25,50	5	011629066
200	29,50	5	011629070

1162BMK



L mm	€	🔧	📄
160	37,00	3	011629036
200	41,00	3	011629040

1162GBMK



L mm	€	🔧	📄
160	31,50	3	011629266
200	37,50	3	011629270

1164K



L mm	€	🔧	📄
160	32,50	5	011649006
200	37,00	5	011649010

1164BMK



L mm	€	🔧	📄
160	40,00	3	011649036
200	45,00	3	011649040

1166K



L mm	€	🔧	📄
160	30,00	5	011669006
200	35,00	5	011669010

1166GK

L mm	€	Hand	Product Code
160	25,50	5	011669066
200	29,50	5	011669070

1166BMK

L mm	€	Hand	Product Code
160	37,00	3	011669036
200	41,00	3	011669040

1166GBMK

L mm	€	Hand	Product Code
160	31,50	3	011669266
200	37,50	3	011669270

1168K

L mm	€	Hand	Product Code
160	32,50	5	011689006
200	37,00	5	011689010

1168GK

L mm	€	Hand	Product Code
160	28,00	5	011689066
200	31,50	5	011689070

1168BMK

L mm	€	Hand	Product Code
160	40,00	3	011689036
200	45,00	3	011689040

1168GBMK

L mm	€	Hand	Product Code
160	35,50	3	011689266
200	40,00	3	011689270

1201E/K

SxAxL mm	€	Hand	Product Code
0,4x2,5x50	4,65	5	012019203
0,4X2,5x75	4,85	5	012019206
0,5x3x75	4,90	5	012019209
0,5x3x100	5,30	5	012019212
0,6x3,5X75	5,30	5	012019218
0,6x3,5x100	5,50	5	012019221
0,8x4x100	5,50	5	012019230
0,8x4x125	5,80	5	012019233
0,8x4X150	6,30	5	012019236
1,0x5,5x100	6,80	5	012019239
1,0x5,5X125	7,20	5	012019240
1,0x5,5x150	7,30	5	012019242
1,2x6,5x100	8,10	5	012019248
1,2x6,5x125	8,40	5	012019250
1,2x6,5x150	8,50	5	012019251
1,2x8x150	11,00	3	012019257
1,2x8X200	11,60	3	012019260
1,6x10x200	13,50	3	012019266

1201EN/K

SxAxL mm	€	Hand	Product Code
0,8x4x30	6,80	3	012019303
1,2x6,5x30	7,00	3	012019306

1202E/K

PHxDxL mm	€	Hand	Product Code
0x3x60	4,85	5	012029203
0x3X100	5,50	5	012029206
1x4,5x80	6,30	5	012029209
1x4,5x120	7,00	5	012029212
2x6x100	8,40	5	012029218
2x6x150	9,00	5	012029221
3x8x150	11,30	3	012029224
4x9,5x200	14,70	3	012029227

1202EN/K

PHxDxL mm	€	Hand	Product Code
1x4,5x30	6,80	3	012029303
2x6x30	7,00	3	012029306

1204E/K

SxDxL mm	€	Hand	Product Code
0,4x2,5x60	4,80	5	012049103
0,6x3x75	4,90	5	012049106
0,5x3x100	5,10	5	012049109
0,8x4x100	5,70	5	012049112
0,8x4x125	5,90	5	012049115
1,0x5x125	6,90	5	012049118
1,0x5x150	7,40	5	012049121
1,2x6,5x150	8,10	5	012049124

1207E TX/K

Type	€	Hand	Product Code
T5	7,20	5	012079105
T6	7,60	5	012079106
T7	7,80	5	012079107
T8	7,90	5	012079108
T9	8,30	5	012079109
T10	9,40	5	012079110
T15	9,50	5	012079115
T20	9,60	5	012079120
T25	9,90	5	012079125
T27	10,50	5	012079127
T30	10,60	5	012079130
T40	12,40	2	012079140
T45	13,60	2	012079145

1208E RTX/K

Type	€	Hand	Product Code
T9	8,40	5	012089109
T10	9,40	5	012089110
T15	9,90	5	012089115
T20	10,10	5	012089120
T25	10,30	5	012089125
T27	11,00	5	012089127
T30	11,50	5	012089130
T40	13,70	2	012089140

1209E PZ/K

Type	€	Hand	Product Code
PZ 0	5,70	5	012099200
1	7,30	5	012099203
2	9,40	5	012099206
3	14,00	3	012099209
4	15,30	3	012099212



1209EN-PZ/K



	€	U	PC
1	6,80	3	012099303
2	7,00	3	012099306

1253



SxAxL mm	€	U	PC
0,5x3,5x100	11,30	5	012530001

1254



SxAxL mm	€	U	PC
0,5x3x44	12,40	5	012540001

1260K



SxAxL	€	U	PC
0,4x2,5x50	6,50	5	012609003
0,4x2,5x75	6,70	5	012609006
0,5x3x75	6,90	5	012609009
0,5x3x100	7,10	5	012609012
0,6x3,5x75	7,30	5	012609018
0,6x3,5x100	7,40	5	012609021
0,8x4x100	8,10	5	012609030
0,8x4x125	8,40	5	012609033
0,8x4x150	8,80	5	012609036
1x5,5x100	9,30	5	012609039
1x5,5x150	10,30	5	012609042
1,5x6,5x100	11,00	5	012609048
1,2x6,5x150	11,80	5	012609051
1,2x8x150	14,40	3	012609057
1,2x8x200	14,80	3	012609060
1,6x10x200	17,90	3	012609066

1260NK

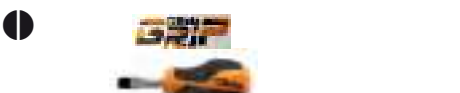

SxAxL mm	€	U	PC
0,8x4x30	8,50	5	012609103
1,2x6,5x30	9,50	5	012609106

1260EK



SxAxL mm	€	U	PC
1,2x6,5x150	15,30	3	012609156
1,2x8x175	18,80	3	012609157
1,6x10x200	21,50	2	012609159
2x12x250	24,90	2	012609162

1262K



PHxDxL mm	€	U	PC
0x3x60	6,90	5	012629003
0x3x100	7,30	5	012629006
1x4,5x80	9,00	5	012629009
1x4,5x120	9,80	5	012629012
2x6x100	11,00	5	012629018
2x6x150	11,90	5	012629021
3x8x150	15,90	3	012629024
4x10x200	20,20	3	012629027

1262NK

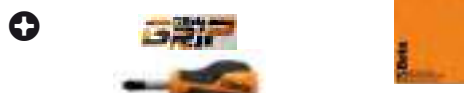

PHxDxL	€	U	PC
1x4,5x30	8,50	5	012629103
2x6x30	9,50	5	012629106

1262EK



PHxDxL mm	€	U	PC
2x6x150	15,30	3	012629153
3x8x175	18,60	3	012629156
4x10x200	23,10	3	012629159

1264K



SxDxL mm	€	U	PC
0,5x2,5x60	6,50	5	012649003
0,6x3x75	6,90	5	012649006
0,6x3x100	7,10	5	012649009
0,8x4x100	8,10	5	012649012
0,8x4x125	8,40	5	012649015
1x5x125	9,50	5	012649018
1x5x150	10,00	5	012649021
1,2x6,5x150	11,80	5	012649024

1267TKK

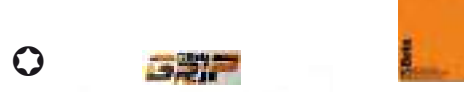

Ø	€	U	PC
T5	9,60	5	012679005
T6	10,00	5	012679006
T7	10,30	5	012679007
T8	10,80	5	012679008
T9	11,10	5	012679009
T10	11,50	5	012679010
T15	12,20	5	012679015
T20	12,80	5	012679020
T25	13,90	5	012679025
T27	14,40	5	012679027
T30	15,20	5	012679030
T40	17,50	2	012679040
T45	19,30	2	012679045

1268RTKK



Ø	€	U	PC
T9	12,00	3	012689009
T10	12,50	3	012689010
T15	12,80	3	012689015
T20	13,90	3	012689020
T25	14,20	3	012689025
T27	15,20	3	012689027
T30	15,40	3	012689030
T40	17,70	2	012689040

1269PZK



PZ	€	U	PC
0	7,90	5	012699000
1	10,20	5	012699001
2	12,00	5	012699002
3	17,10	3	012699003
4	21,70	3	012699004

1269N/PZK



PZ	€	U	PC
1	8,50	5	012699011
2	9,50	5	012699012

1290K



SxAxL mm	€	⚡	📦
0,4x2,5x50	8,30	5	012909003
0,4x2,5x75	8,50	5	012909006
0,5x3x75	8,70	10	012909009
0,5x3x100	9,20	10	012909012
0,6x3,5x75	9,90	10	012909018
0,6x3,5x100	10,10	10	012909021
0,8x4x100	10,20	10	012909030
0,8x4x125	10,50	10	012909033
0,8x4x150	11,00	10	012909036
1x5,5x100	11,20	10	012909039
1x5,5x150	12,40	10	012909042
1,2x6,5x100	13,90	10	012909048
1,2x6,5x150	14,60	10	012909051
1,2x8x150	18,30	3	012909057
1,2x8x200	19,40	3	012909060
1,6x10x200	22,50	3	012909066

1290NK



SxAxL mm	€	⚡	📦
0,8x4x30	10,70	5	012909103
1,2x6,5x30	11,70	5	012909106

1290K/INOX



SxAxL mm	€	⚡	📦
0,4x2,5x50	10,60	4	012909403
0,5x3x75	10,90	4	012909409
0,8x4x100	11,10	4	012909430
1,0x5,5x150	14,10	4	012909442
1,2x6,5x150	16,10	4	012909451

1292K



PHxDxL mm	€	⚡	📦
0x3x60	7,90	10	012929003
0x3x100	9,00	5	012929006
1x4,5x80	10,80	10	012929009
1x4,5x120	11,80	10	012929012
2x6x100	14,10	10	012929018
2x6x150	15,00	10	012929021
3x8x150	19,20	3	012929024
4x10x200	26,00	3	012929027

1292NK



PHxDxL mm	€	⚡	📦
1x4,5x30	10,30	5	012929103
2x6x30	11,10	5	012929106

1292K/INOX



PHxDxL mm	€	⚡	📦
0x3x60	9,90	4	012929403
1x4,5x80	11,50	4	012929409
2x6x100	14,10	4	012929418

1294K



SxDxL mm	€	⚡	📦
0,5x2,5x60	7,70	5	012949003
0,6x3x75	8,20	5	012949006
0,8x4x100	10,20	5	012949012
1x5x125	12,50	5	012949018

1298RTXK



⊕	€	⚡	📦
T9	16,70	5	012989009
T10	17,00	5	012989010
T15	18,00	5	012989015
T20	18,10	5	012989020
T25	18,70	5	012989025
T27	20,00	5	012989027
T30	20,60	5	012989030
T40	22,10	2	012989040

1299PZK



PZ	€	⚡	📦
0	11,20	5	012999000
1	13,20	5	012999003
2	17,70	5	012999006

1299N/PZK



PZ	€	⚡	📦
1	12,70	5	012999021
2	14,10	5	012999024

1472VW



L mm	€	⚡	📦
200	54,00	1	014720051

1473P



A Max mm	€	⚡	📦
53	42,00	1	014730020

1497BS

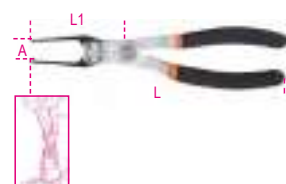

L mm	€	⚡	📦
230	27,00	1	014970190

1497SS



L mm	€	⚡	📦
245	24,50	1	014970195



1497RC



1497RC € 87,50 1 014970351

1600Q 8



1600Q 8 € 34,00 1 016000008

1600Q 10



1600Q 10 € 43,00 1 016000010

1603K



mm² 0÷8 € 18,70 5 016039001

1603BK



mm² 0÷8 € 69,00 2 016039010

1651DGTB

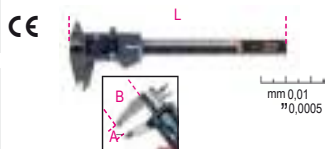

A Max mm	€		
150	113,00	1	016510211
200	147,00	1	016510212
300	192,00	1	016510213

Beta

QUALITY TOOLS

1651DGTB/IP

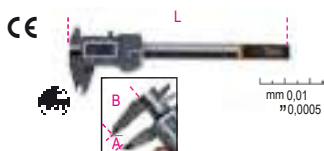

A Max mm	€		
150	185,00	1	016510711

1691BM



L m	€		
5	17,60	1	016910205
8	26,50	1	016910208
10	32,00	1	016910210

1691MG



L m	€		
5	15,90	1	016910405
8	22,20	1	016910408
10	23,40	1	016910410

1692



L m	€		
2	8,60	5	016920052
3	10,70	5	016920053
5	15,30	5	016920055
8	22,00	5	016920058

1693

CE



IP54



H mm 100 € 135,00 1 016930020

1729CG



L mm 310 € 26,00 2 017290200

1729DM 450



L mm 450 € 29,50 4 017290450

1741U



Ø mm	2,4	3	3,2	4	4,8
Aluminio	•	•	•	•	•
Aço	•	•	•	•	
Aço inoxidável	•	•	•	•	

1741U € 51,00 1 017410450



1741B



250 mm

Ø mm	2,4	3,2	4	4,8	5
Alluminio
Aço
Aço inoxidável

1741B	€ 43,00	1	017410000
-------	---------	---	-----------

1760K

CE



180 mm

CAT III-1000V

1760K	€ 43,00	1	017600140
-------	---------	---	-----------

1762K



Ø mm	€		
2-2,5-3	37,00	2	017629001
3,5-4-4,5			

1771



18 mm

170 mm

1771	€ 10,30	10	017710000
------	---------	----	-----------

1770BM



L mm	€		
140	13,90	10	017700050

1771BM



L mm	€		
170	22,50	10	017710050

1771HD



L mm	€		
190	25,50	5	017710100

1772R



L mm	€		
125	19,00	5	017720006

1773A



L mm	€		
180	20,00	10	017730000

1773S



L mm	€		
190	9,40	1	017730100

1777BMT



L mm	€		
170	30,50	5	017770050

1777T



L mm	€		
160	28,50	5	017770030

1778MT

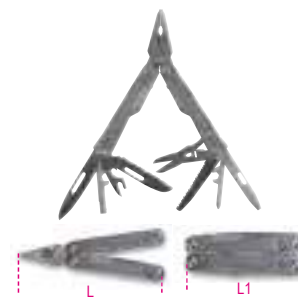

L mm	€		
180	109,00	1	017780055

1783



L mm	€		
215	16,70	5	017830021
240	18,70	5	017830024

1820



1820 30 30W L = 210mm	€ 56,50	1	018200003
1820 60 60W L = 220mm	€ 64,50	1	018200006
1820 80 80W L = 260mm	€ 91,50	1	018200008

Beta

1822



1822 120	139,00	1	018220012
120W			
LxA = 250x125 mm			
1822 180	148,00	1	018220018
180W			
LxA = 250x125mm			
1822 320	184,00	1	018220032
320W			
LxA = 250x140mm			

1833XSW



L mm	€	1	018330011
145	54,00		

1833S



L mm	€	1	018330002
150	43,00		

1833M



L mm	€	1	018330003
162	54,00		

1833MW



L mm	€	1	018330013
160	99,00		

Beta

1833L



L mm	€	1	018330004
196	90,00		

1833XL



L mm	€	1	018330005
300	113,00		

1833L/USB



L mm	€	1	018330054
240	133,00		

1836AW



1836AW	81,50	1	018360051
--------	-------	---	-----------

1836B



1836B	148,00	1	018360200
-------	--------	---	-----------

1837F



L mm	€	1	018370050
460	98,00		

1837F/USB



L mm	€	1	018370060
460	145,00		

1838COB



1838COB	106,00	1	018380010
---------	--------	---	-----------



1838P



1838P € 90,50 1 018380005

1838POCKET



L mm 98 € 77,00 1 018380080

1838SLIM

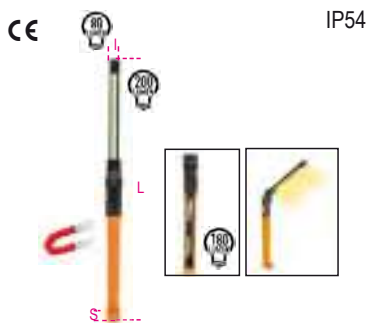

L mm 307 € 82,50 1 018380221

1838SW



L mm 260 € 110,00 1 018380142

1839BRW



L mm 101 € 104,00 1 018390002

1860M



L max mm 30 € 107,00 1 018600301

1875SP/K3



1875SP/K3 € 21,20 1 018750010

1949F2



g 125 € 15,70 1 019490028

1949XS



g 20 € 6,30 25 019490025

6888B1/4

Suporte blister para chaves 1/4"



6888B1/4 € 0,72 50 068880900

6888B3/8

Suporte blister para chaves 3/8"



6888B3/8 € 0,85 50 068880910

6888B1/2

Suporte blister para chaves 1/2"



6888B1/2 € 0,85 50 068880920



Beta

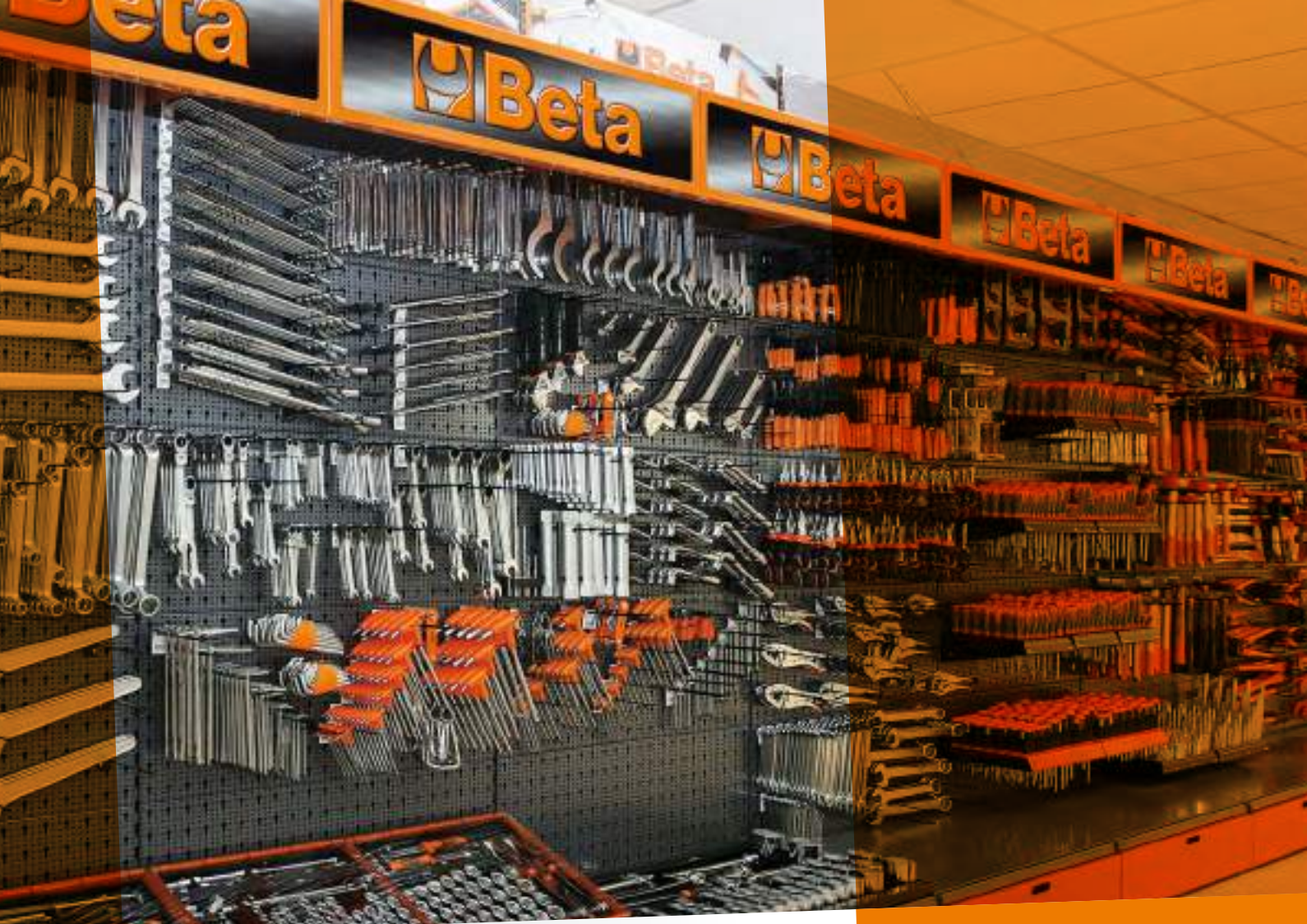

EXPOSITORES PARA POSTOS DE VENDA

SHOP
in Shop



CONFIGURE O SEU ESPAÇO BETA

www.beta-tools.com/planner3d/

38/DS1

expositor de parede
com 75 punções e escopos



495x260x332 mm

Expositor completo
38/DS1 € 820,00 1 000380701

	n.
30 Ø 2 - 3 - 4 - 5 - 6 mm	5
31 Ø 2 - 3 - 4 - 5 - 6 - 8 - 10 mm	5
32 Ø 3 - 4 - 5 mm	5

Expositor vazio
38/DVS1 € 122,00 1 000380751

38/DS2

expositor de parede
com 65 punções e escopos

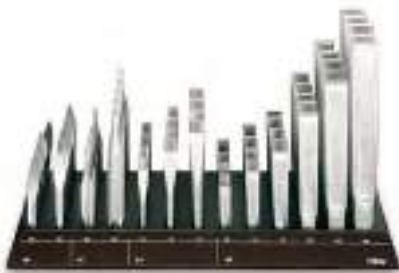

495x260x332 mm

Expositor completo
38/DS2 € 1.550,00 1 000380702

	n.
34 125 - 150 - 175 mm	5
35 100 - 125 - 150 - 200 - 250 - 300 mm	5
36 125 - 150 mm	5
37 150 - 200 mm	5

Expositor vazio
38/DVS2 € 122,00 1 000380752

942BX/DG

expositor de parede
com 43 chaves de caixa com punho,
série curta



330x260x332 mm

Expositor completo
942BX/DG € 825,00 1 009420701

	n.
○ 942BX 5 - 5,5 mm	3
6 - 7 mm	6
8 - 9 - 10 mm	5
11 mm	2
12 mm	3
13 mm	5

Expositor vazio
942BX/DVG € 108,00 1 009420751

943BX/DG

expositor de parede
com 43 chaves de caixa com punho,
série longa



330x260x332 mm

Expositor completo
943BX/DG € 885,00 1 009430701

	n.
○ 943BX 5 - 5,5 mm	3
6 - 7 mm	6
8 - 9 - 10 mm	5
11 mm	2
12 mm	3
13 mm	5

Expositor vazio
943BX/DVG € 108,00 1 009430751

944BX/DG

expositor de parede de 43 chaves de caixa
sextavadas profundas, com punho,
modelo longo de binário elevado



330x260x332 mm

Expositor completo
944BX/DG € 1.030,00 1 009440701

	n.
○ 944BX 5 - 5,5 mm	3
6 - 7 mm	6
8 - 9 - 10 mm	5
11 mm	2
12 mm	3
13 mm	5

Expositor vazio
944BX/DVG € 108,00 1 009440751

943MQ/BG

expositor de parede
com 30 chaves de caixa com punho



⚡ 1000 V ⚡

330x260x332 mm

Expositor completo
943MQ/BG € 680,00 1 009430281

	n.
○ 943MQ 5,5 - 6 - 7 - 8 - 10 - 13 mm	5

Expositor vazio
943BG-MQ/DV € 108,00 1 009430285

1203/E1P

expositor de parede
com 82 chaves de parafusos



495x260x310 mm

Expositor completo
1203E/E1P € 510,00 1 012031301

		n.
● 1201	0,4x2,5x50 - 0,5x3x75 - 0,6x3,5x100 0,8x4x100 - 0,8x4x125 mm	7
	1,0x5,5x100 - 1,0x5,5x150 - 1,2x6,5x150 mm	6
	1,2x8x150 mm	5
⊕ 1202	PH0x3x60 mm	7
	PH1x4,5x80 - PH2x6x100 mm	6
	PH3x8x150 mm	5

Expositor vazio
1203E/EV1P € 135,00 1 012031351

1203/E4P

expositor de parede
com 85 chaves de parafusos



495x260x310 mm

Expositor completo
1203E/E4P € 491,00 1 012031304

		n.
● 1201	0,4x2,5x50 - 0,5x3x75 - 0,8x4x125 mm	7
	1,0x5,5x100 - 1,0x5,5x150 - 1,2x6,5x150 mm	6
● 1204	0,4x2,5x60 - 0,5x3x100 - 0,8x4x100 mm	7
	1,0x5x125 mm	6
⊕ 1209PZ	PZ0x3x60 mm	7
	PZ1x4,5x80 - PZ2x6x100 mm	6

Expositor vazio
1203E/EV4P € 135,00 1 012031354

1203/E5P

expositor de parede
com 82 chaves de parafusos



495x260x310 mm

Expositor completo
1203E/E5P € 520,00 1 012031305

		n.
⊕ 1202	PH0x3x60 mm	7
	PH1x4,5x80 - PH1x4,5x120 PH2x6x100 - PH2x6x150 mm	6
	PH3x8x150 mm	5
● 1204	0,4x2,5x60 - 0,5x3x100 - 0,8x4x100 mm	7
	1,0x5x125 mm	6
⊕ 1209PZ	PZ0x3x60 mm	7
	PZ1x4,5x80 - PZ2x6x100 mm	6

Expositor vazio
1203E/EV5P € 135,00 1 012031355

1203/E10P

expositor de parede
com 80 chaves de parafusos



495x260x310 mm

Expositor completo
1203E/E10P € 700,00 1 012031310

		n.
⊕ 1207TX	T6	4
	T7	3
	T8	7
	T9 - T10 - T15 - T20 - T25	6
	T27 - T30	3
⊕ 1208RTX	T9 - T10	3
	T15 - T20 - T25	6
	T27 - T30	3

Expositor vazio
1203E/EV10P € 135,00 1 012031360

1263/E78

expositor para parede com 78 chaves de fendas



495x260x310 mm

Expositor completo
1263/E78 € 675,00 1 012630510

● 1260	2,5x75-3x75-3,5x100 mm	7
	4x100-4x125-5,5x100-5,5x150-6,5x150 mm	6
	8x150 mm	4
⊕ 1262	PH0x60 mm	7
	PH1x80-PH2x100 mm	6
	PH3x150	4

Expositor vazio
1263/EV78 € 125,00 1 012630511

1263/E74

expositor de parede
com 74 chaves de fendas



495x260x310 mm

Expositor completo
1263/E74 € 635,00 1 012630540

● 1264	2,5x60 mm	7
	3x75 mm	3
	3x100 - 4x100 mm	4
	4x125 - 5x150 mm	2
	5x125 - 6,5x150 mm	4
⊕ 1262	PH 8x150	3
	PH 3x60 - 3x100 mm	7
	PH 4,5x80 - 4,5x120 mm	6
	PH 6x100 mm	10
	PH 6x150 mm	5

Expositor vazio
1263/EV74 € 125,00 1 012630541

1263/E85

expositor de parede
com 85 chaves de parafusos



495x260x377 mm

Expositor completo
1263/E85 € 755,00 1 012630550

	n.
● 1260 2,5x50 mm	7
2,5x75 mm	6
3x75 - 3x100 - 3,5x100 mm	7
4x100 - 4x125 - 5,5x125	6
5,5x150 - 6,5x150 mm	4
8x150 mm	3
● 1260E 10x200 mm	2
12x250 mm	2
4x30 - 6,5x30 mm	6

Expositor vazio
1263/EV85 € 125,00 1 012630551

1263/E70

expositor de parede
com 70 chaves de parafusos



495x260x327 mm

Expositor completo
1263/E70 € 740,00 1 012630560

	n.
⊕ 1262 PH0x60 - PH0x100 mm	7
PH1x80 - PH1x120 mm	6
PH2x100 mm	9
PH2x150 - PH3x150 mm	5
PH4x200 mm	4
⊕ 1262E PH2x150 mm	5
PH3x175 mm	4
⊕ 1262N PH1x30 - PH2x30 mm	6

Expositor vazio
1263/EV70 € 125,00 1 012630561

1263/E50

expositor de parede
com 50 chaves de parafusos



330x260x269 mm

Expositor completo
1263/E50 € 388,00 1 012630570

	n.
● 1264 2,5x60 - 3x75 - 3x100 mm	7
4x100 - 4x125 - 5x125 - 5x150 mm	6
6,5x150 mm	5

Expositor vazio
1263/EV50 € 108,00 1 012630571

1263/E62

expositor de parede
com 62 chaves de parafusos



495x260x257 mm

Expositor completo
1263/E62 € 715,00 1 012630590

	n.
⊕ 1267TX T5	5
T6	6
T7	5
T8	6
T9	5
T10 - T15 - T20	6
T25	5
T27 - T30	4
T40 - T45	2

Expositor vazio
1263/EV62 € 125,00 1 012630591

1263/E39

expositor de parede
com 39 chaves de parafusos



330x260x257 mm

Expositor completo
1263/E39 € 510,00 1 012630595

	n.
⊕ 1268RTX T9x60 - T10x80 - T15x80	6
T20x100 - T25x100 mm	4
T27x115 mm	3
T30x115 mm	2
T40x130 mm	2

Expositor vazio
1263/EV39 € 108,00 1 012630596

1263/E40

expositor de parede
com 40 chaves de parafusos



330x260x327 mm

Expositor completo
1263/E40 € 449,00 1 012630580

	n.
⊕ 1269 PZ0x60 mm	7
PZ1x80 mm	6
PZ2x100 - PZ3x150 - PZ4x200 mm	5
⊕ 1269N PZ1x30 - PZ2x30 mm	6

Expositor vazio
1263/EV40 € 108,00 1 012630581

1273MQ/E1

expositor de parede
com 40 chaves de parafusos



△ 1000 V

330x260x332 mm

Expositor completo
1273MQ/E1 € 570,00 1 012730312

	n.
➕ 1272MQ PH0x60 - PH1x80 mm	5
PH2x100 mm	3
PH3x150 mm	2
● 1274MQ 3x100 - 4x100 - 5,5x125 - 6,5x150 mm	5
8x175 mm	3
10x200 mm	2

Expositor vazio
1273BG-MQ/DV € 108,00 1 012730651

1273MQ/E4

expositor de parede
com 43 chaves para parafusos



△ 1000 V

330x260x332 mm

Expositor completo
1273MQ/E4 € 775,00 1 012730315

➕ 1272MQF 4,5x80 - 6x100 mm	3
● 1274MQF 3,5x100 - 4,5x100 - 5,5x125 - 6,5x150 mm	3
➕ 1275MQ/C 4,5x80 - 6x100 mm	5
➕ 1276MQ/C 4,5x80 - 6x100 mm	5
➕ 1279MQ/F 4,5x80 mm	3
6x100 mm	2

Expositor vazio
1273BG-MQ/DV4 € 108,00 1 012730655

1293BX/DA

expositor de parede
com 90 chaves de parafusos



495x260x332 mm

Expositor completo
1293BX/DA € 1.010,00 1 012930701

● 1290 3x75 - 3,5x100 - 4x100 - 4x125	7
5,5x100 - 5,5x150 mm	6
6,5x150 mm	3
8x150 mm	2
10x200 mm	3
● 1290N 4x30 - 6,5x30 mm	7
➕ 1292 PH0x60 - PH1x80 mm	6
PH2x100 mm	5
PH3x150 mm	3
➕ 1292N PH1x30 - PH2x30 mm	3

Expositor vazio
1293BX/DVA € 125,00 1 012930751

1293BX/DD

expositor de parede
com 48 chaves de parafusos



330x260x332 mm

Expositor completo
1293BX/DD € 476,00 1 012930704

● 1294 2,5x60 - 3x75 - 3x100 - 4x100	7
4x150 - 5x125 mm	6
6,5x150 mm	6

Expositor vazio
1293BX/DVD € 109,00 1 012930754

1293BX/DE

expositor de parede
com 42 chaves de parafusos



330x260x332 mm

Expositor completo
1293BX/DE € 710,00 1 012930705

➕ 1299PZ PZ0x60 - PZ1x80 mm	7
PZ2x100 mm	6
PZ3x150 - PZ4x200 mm	5
➕ 1299N/PZ PZ1x30 - PZ2x30 mm	6

Expositor vazio
1293BX/DVE € 109,00 1 012930755

1293BX/DF

expositor de parede
com 59 chaves de parafusos



330x260x332 mm

Expositor completo
1293BX/DF € 940,00 1 012930706

● 1297TX T6 - T8 - T10 - T15 - T20 - T25	7
T27 - T30	6
T40	5

Expositor vazio
1293BX/DVF € 109,00 1 012930756

C68

expositor de parede Beta, vazio



1000x560x2200 mm

		€		
C68/1	1 m	2.320,00	1	068000001
C68/2	2 m	4.030,00	1	068000002
C68/3	3 m	5.750,00	1	068000003
C68/4	4 m	7.500,00	1	068000004
C68/5	5 m	9.200,00	1	068000005
C68/6	6 m	10.900,00	1	068000006
C68/7	7 m	12.600,00	1	068000007
C68/8	8 m	14.400,00	1	068000008
C68/9	9 m	16.100,00	1	068000009
C68/10	10 m	17.800,00	1	068000010

C68N

expositor de parede Beta, vazio



1000x560x2200 mm

		€		
C68N/1	1 m	2.000,00	1	068000031
C68N/2	2 m	3.710,00	1	068000032
C68N/3	3 m	5.450,00	1	068000033
C68N/4	4 m	7.150,00	1	068000034
C68N/5	5 m	8.850,00	1	068000035
C68N/6	6 m	10.600,00	1	068000036
C68N/7	7 m	12.300,00	1	068000037
C68N/8	8 m	14.000,00	1	068000038
C68N/9	9 m	15.700,00	1	068000039
C68N/10	10 m	17.500,00	1	068000040

C68 G

expositor tipo "gôndola"



1000x1120x1600 mm

		€		
C68G/1	1 m	2.110,00	1	068000051
C68G/2	2 m	3.880,00	1	068000052
C68G/3	3 m	5.650,00	1	068000053
C68G/4	4 m	7.450,00	1	068000054

C88 R/1

expositor de parede Robur, vazio



1000x560x2200 mm

		€		
C88R/1	1 m	2.350,00	1	088000001

C88NR/1

expositor de parede Robur, vazio



1000x560x2200 mm

		€		
C88NR/1	1 m	2.030,00	1	088000031

C88VE

tabuleiro para expositor de parede C88

adequado para bobinas das correntes artigo 8120



		€		
C88VE		251,00	1	088000120

C88SE

tabuleiro para expositor Genovese adequado para bobinas de corrente



		€		
C88SE		605,00	1	088000130

1700x600x600 mm



6888

ganchos para expositores
C60 - C61 - C68 - C88



	€	U	PC
6888S1	4,75	10	068880011
6888S2	4,75	10	068880012
6888D1	7,50	5	068880021
6888D2	7,50	5	068880022
6888D4	7,80	5	068880024
6888D5	7,80	5	068880025
6888T1	10,70	5	068880031
6888T2	10,70	5	068880032
6888CT	20,10	1	068880044
6888B	71,50	1	068880100
6888GA	23,60	3	068880120
6888S-1/4	43,00	1	068880605
6888S-3/8	43,00	1	068880610

6800 VE

vitrina para expositores C68 e C68 R/1



	€	U	PC
6800VE/1	1 m	1.160,00	1 068000401
6800VE/2	2 m	1.760,00	1 068000402
6800VE/3	3 m	2.370,00	1 068000403
6800VE/4	4 m	2.970,00	1 068000404
6800VE/5	5 m	3.580,00	1 068000405



	€	U	PC
6800AE	231,00	1	068000145
6800AI	476,00	1	068000140
6800AD/P	810,00	1	068000143



	€	U	PC
6800CB/100	266,00	1	068000104
6800FB/100	94,00	1	068000109
6800FO/100	64,50	1	068000108
6800PL	270,00	1	068000137
6800RP/100	85,50	1	068000150
6800GR/37	36,00	1	068000159

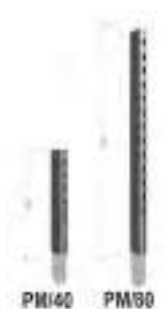

	€	U	PC
6800PM/40	85,50	1	068000171
6800PM/80	116,00	1	068000172

6600 M/14

jogo de 154 ferramentas, com ganchos e sem painel



	€	U	PC
6600 M/14	2.660,00	1	066000014

6600 M/22

sortido de 108 ferramentas,
com ganchos, sem painel



	€	U	PC
6600 M/22	1.800,00	1	066000022

6600 M/27

jogo com 25 ferramentas
com ganchos, sem painel



	€	U	PC
6600 M/27	1.260,00	1	066000027

6600 M/29

jogo de 173 ferramentas, com ganchos e sem
painel

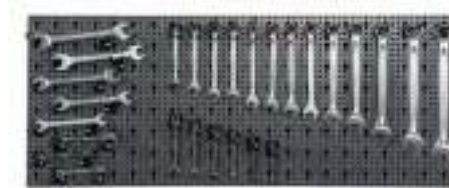

	€	U	PC
6600 M/29	2.350,00	1	066000029

6600 M/33

Sortido de 37 ferramentas com ganchos e
sem painel



	€	U	PC
6600 M/33	2.010,00	1	066000033

Beta

6600 M/40

jogo de 100 ferramentas,
com ganchos e sem painel



6600 M/40 € 2.980,00 1 066000040

6600 M/42

jogo de 65 ferramentas,
com ganchos sem painel



6600 M/42 € 1.920,00 1 066000042

6600 M/44

jogo de 48 ferramentas, com ganchos e sem
painel

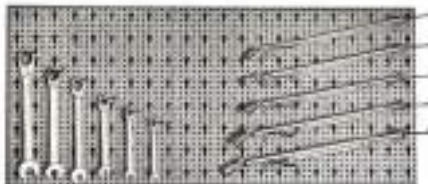

6600 M/44 € 1.670,00 1 066000044

6600 M/47

jogo com 65 ferramentas
com ganchos, sem painel



6600 M/47 € 1.790,00 1 066000047

6600 M/51

jogo de 257 ferramentas
com ganchos, sem painel



6600 M/51 € 3.180,00 1 066000051

6600 M/52

jogo de 176 ferramentas
com ganchos, sem painel



6600 M/52 € 2.080,00 1 066000052

6600 M/58

jogo de 150 ferramentas
com ganchos, sem painel



6600 M/58 € 2.260,00 1 066000058

6600 M/59

jogo de 220 ferramentas, com ganchos e sem
painel



6600 M/59 € 2.400,00 1 066000059

6600 M/61

sortido de 71 ferramentas,
com ganchos, sem painel



6600 M/61 € 2.870,00 1 066000061

6600 M/62

jogo de 28 ferramentas,
com ganchos, sem painel



6600 M/62 € 675,00 1 066000062

6600 M/63

jogo de 110 ferramentas
com ganchos, sem painel

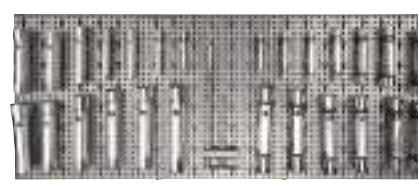

6600 M/63 € 2.610,00 1 066000063

6600 M/73

jogo de 68 ferramentas
com ganchos, sem painel



6600 M/73 € 1.710,00 1 066000073

6600 M/112

jogo de 329 ferramentas,
com ganchos e sem painel



6600 M/112 € 2.810,00 1 066000112

6600 M/116

jogo de 306 ferramentas,
com ganchos e sem painel



6600 M/116 € 2.630,00 1 066000116

6600 M/120

jogo de 163 ferramentas,
com ganchos e sem painel



6600 M/120 € 1.900,00 1 066000120

6600 M/125

jogo de 133 ferramentas,
com ganchos e sem painel



6600 M/125 € 1.640,00 1 066000125

6600 M/126

jogo de 58 ferramentas,
com ganchos e sem painel



6600 M/126 € 1.010,00 1 066000126

6600 M/131

jogo com 92 ferramentas
com ganchos, sem painel



6600 M/131 € 3.130,00 1 066000131

6600 M/174

Sortido de 13 ferramentas com ganchos e
sem painel



6600 M/174 € 4.760,00 1 066000174

6600 M/175

jogo de 12 ferramentas,
com ganchos sem painel



6600 M/175 € 3.440,00 1 066000175

6600 M/217

jogo de 74 ferramentas, com ganchos e sem
painel



6600 M/217 € 2.940,00 1 066000217

6600 M/218

jogo de 58 ferramentas, com ganchos e sem
painel



6600 M/218 € 1.560,00 1 066000218

6600 M/222

jogo de 74 ferramentas, com ganchos e sem
painel

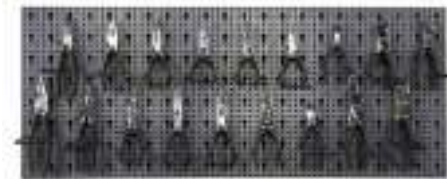

6600 M/222 € 2.390,00 1 066000222

6600 M/223

jogo de 58 ferramentas, com ganchos e sem
painel



6600 M/223 € 2.030,00 1 066000223

6600 M/230

jogo de 78 ferramentas,
com ganchos e sem painel



6600 M/230 € 2.610,00 1 066000230

6600 M/236

jogo de 31 ferramentas,
com ganchos e sem painel



6600 M/236 € 1.470,00 1 066000236

6600 M/241

sortido de 43 ferramentas,
com ganchos sem painel

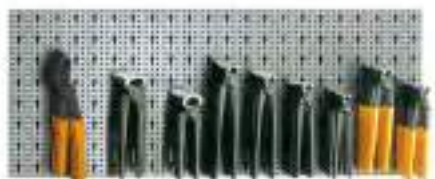

6600 M/241 € 1.270,00 1 066000241

6600 M/242

jogo de 91 ferramentas, com ganchos e sem painel



6600 M/242 € 3.010,00 1 066000242

6600 M/253

jogo de 60 ferramentas, com ganchos e sem painel



6600 M/253 € 2.220,00 1 066000253

6600 M/311

jogo de 114 ferramentas,
com ganchos, sem expositor



6600 M/311 € 1.290,00 1 066000311

6600 M/315

jogo de 149 ferramentas,
com ganchos e sem painel



6600 M/315 € 2.130,00 1 066000315

6600 M/320

jogo de 98 ferramentas,
com ganchos e sem painel



6600 M/320 € 1.950,00 1 066000320

6600 M/326

jogo de 155 ferramentas,
com ganchos e sem painel

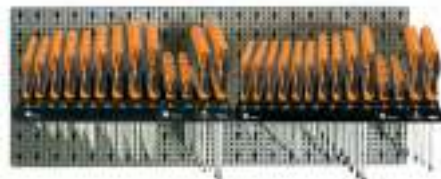

6600 M/326 € 1.490,00 1 066000326

6600 M/327

jogo de 101 ferramentas,
com ganchos e sem painel



6600 M/327 € 1.230,00 1 066000327

6600 M/330

jogo de 110 ferramentas,
com ganchos e sem painel



6600 M/330 € 1.010,00 1 066000330

6600 M/371

jogo de 162 ferramentas, com ganchos e sem painel



6600 M/371 € 1.210,00 1 066000371

6600 M/380

sortido com 71 ferramentas,
com ganchos, sem painel



6600 M/380 € 780,00 1 066000380

6600 M/406

jogo de 107 ferramentas, com ganchos e sem
painel

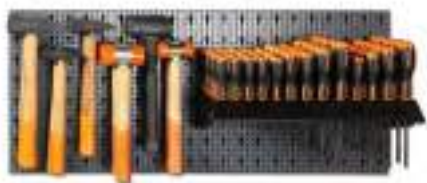

6600 M/406 € 1.380,00 1 066000406

6600 M/417

jogo de 43 ferramentas,
com ganchos, sem painel



6600 M/417 € 1.190,00 1 066000417

6600 M/423

Sortido de 30 ferramentas com ganchos e
sem painel



6600 M/423 € 1.190,00 1 066000423

6600 M/424

Sortido de 36 ferramentas com ganchos e
sem painel



6600 M/424 € 1.260,00 1 066000424

6600 M/427

jogo de 24 ferramentas,
com ganchos e sem painel



6600 M/427 € 1.290,00 1 066000427

6600 M/430

jogo de 29 ferramentas,
com ganchos e sem painel



6600 M/430 € 1.260,00 1 066000430

6600 M/440

jogo de 140 ferramentas,
com ganchos e sem painel

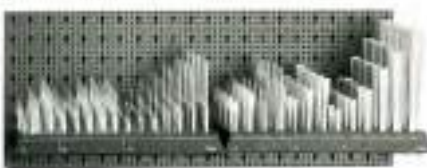

6600 M/440 € 2.370,00 1 066000440

6600 M/456

jogo de 41 ferramentas,
com ganchos, sem expositor



6600 M/456 € 1.610,00 1 066000456

6600 M/465

Sortido de 36 ferramentas com ganchos e
sem painel



6600 M/465 € 2.060,00 1 066000465

6600 M/480

jogo de 18 ferramentas,
com ganchos e sem painel



6600 M/480 € 1.300,00 1 066000480

6600 M/485

jogo de 12 ferramentas,
com ganchos e sem painel

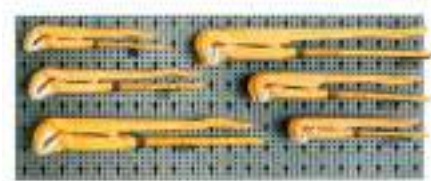

6600 M/485 € 935,00 1 066000485

6600 M/510

jogo de 16 ferramentas,
com ganchos e sem painel



6600 M/510 € 1.290,00 1 066000510

6600 M/532

jogo de 24 ferramentas
com ganchos, sem painel



6600 M/532 € 1.060,00 1 066000532

6600 M/534

jogo de 51 ferramentas,
com ganchos e sem painel



6600 M/534 € 1.690,00 1 066000534

6600 M/542

sortido de 53 ferramentas,
com ganchos sem painel



6600 M/542 € 1.050,00 1 066000542

6600 M/548

jogo de 37 ferramentas,
com ganchos, sem painel



6600 M/548 € 1.010,00 1 066000548

6600 M/561

jogo de 60 ferramentas,
com ganchos sem painel



6600 M/561 € 1.450,00 1 066000561

6600 M/583

jogo de 22 ferramentas
com ganchos, sem painel



6600 M/583 € 960,00 1 066000583

6600 M/643

sortido com 90 ferramentas,
com ganchos, sem painel

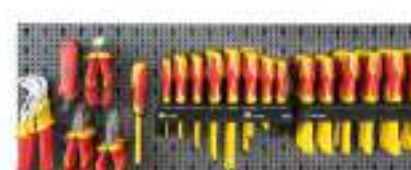

6600 M/643 € 2.310,00 1 066000643

6600 M/650

jogo de 28 ferramentas,
com ganchos e sem painel



6600 M/650 € 2.820,00 1 066000650

6600 M/657

jogo de 17 ferramentas,
com ganchos sem painel



6600 M/657 € 2.290,00 1 066000657

6600 M/658

jogo de 14 ferramentas
com ganchos, sem painel



6600 M/658 € 2.550,00 1 066000658



6600 M/716

jogo de 64 ferramentas,
com ganchos e sem painel



6600 M/716 € 2.340,00 1 066000716

6600 M/813

Sortido de 25 ferramentas com ganchos e
sem painel



6600 M/813 € 1.370,00 1 066000813

6600 M/842

Sortido de 36 ferramentas com ganchos e
sem painel



6600 M/842 € 1.780,00 1 066000842

6600 M/852

sortido de 560 disco abrasivos duros, com
ganchos e sem painel



6600 M/852 € 1.720,00 1 066000852

6600 M/856

sortido de 560 disco abrasivos duros, com
ganchos e sem painel



6600 M/856 € 1.810,00 1 066000856

6600 M/857

sortido de 560 disco abrasivos duros, com
ganchos e sem painel



6600 M/857 € 1.900,00 1 066000857

6600 M/871

jogo de 120 abrasivos
com ganchos sem painel



6600 M/871 € 770,00 1 066000871

6600 M/878

jogo de 100 abrasivos
com ganchos sem painel



6600 M/878 € 725,00 1 066000878

6600 M/881

jogo de 410 abrasivos
com tabuleiro expositor



6600 M/881 € 2.140,00 1 066000881



8600 R/11

Jogo de 374 acessórios para cabos, com
ganchos, sem painel

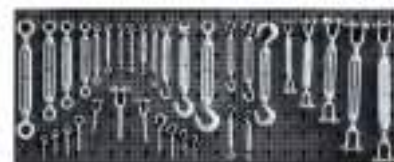

8600 R/11 € 1.820,00 1 086000011

8600 R/12

jogo com 259 acessórios para cabos, com
ganchos sem painel

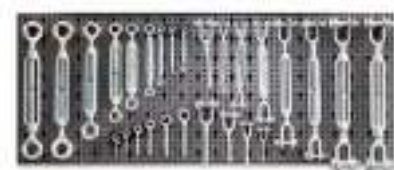

8600 R/12 € 1.770,00 1 086000012



8600 R/13

jogo com 230 acessórios para cabos, com ganchos sem painel



8600 R/13 € 1.500,00 1 086000013

8600 R/113

jogo com 1862 acessórios para cabos, com ganchos sem painel



8600 R/113 € 2.090,00 1 086000113

8600 R/114

jogo com 1045 acessórios para cabos, com ganchos sem painel



8600 R/114 € 2.060,00 1 086000114

8600 R/225

jogo com 64 acessórios para cabos GRAU 8, com ganchos sem painel



8600 R/225 € 1.410,00 1 086000225

8600 R/412

jogo com 348 acessórios para cabos aço inox, com ganchos sem painel



8600 R/412 € 2.080,00 1 086000412

8600 R/511

jogo de 11 bobinas de corrente Genovese, com tabuleiro para expositor

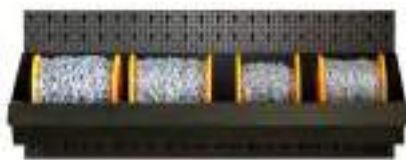

8600 R/511 € 1.730,00 1 086000511

8600 R/601

jogo de 50 esticadores com roquete com prateleira e ganchos, sem painel



8600 R/601 € 1.150,00 1 086000601
C88/R601 € 339,00 1 088000160

8600 R/611

jogo de 52 estopos com ganchos, sem painel



8600 R/611 € 905,00 1 086000611
C88/R611 € 198,00 1 088000161



CALÇADO DE SEGURANÇA

LEGENDA



Com palmilha antipenetração



Resistência à flexão repetida > 60.000



Com biqueira



Sola resistente ao calor de contato (300 °C/min.)



Calçado antiestático



Calçado não magnético, totalmente isento de peças metálicas



Absorção de energia da região do calcanhar



Calçado desenvolvido para garantir a dissipação constante das cargas eletrostáticas do corpo do utilizador para o solo



Sola à prova de óleo, hidrocarbonetos e solventes



Formato largo (11) para maior conforto



Rasto antiderrapante



Calçado desenvolvido para proporcionar isolamento ao frio (-20 °C)

AVISOS

Antes da utilização, assegure que o calçado é adequado para as suas necessidades e possui uma classe de proteção adaptada ao tipo e local de trabalho. O calçado fabricado pela Beta Utensili cumple as atuais NORMAS EUROPEIAS.

O empregador deve disponibilizar equipamento de proteção pessoal adequado aos colaboradores expostos a situações de risco (características e categoria do EPI - Equipamento de Proteção Individual).

OBSOLESCÊNCIA

Devido aos numerosos fatores envolvidos (humidade durante o armazenamento e alterações estruturais dos materiais com o decorrer do tempo), não é possível determinar a duração exata do sapato em armazenamento. Em geral, o calçado feito inteiramente em poliuretano ou com solas de poliuretano tem uma duração máxima prevista de três anos a partir da data de fabrico. O calçado inteiramente em PVC tem uma vida útil expectável de cinco anos a partir da data de fabrico, enquanto o calçado com gáspea de couro e o calçado em borracha, em material termoplástico e EVA tem uma vida útil expectável máxima de dez anos a partir da data de fabrico. Estes períodos de tempo aplicam-se a calçado novo, embalado e armazenado em condições controladas - ou seja, sem mudanças abruptas de temperatura e de humidade relativa.

NORMAS EUROPEIAS E SIGNIFICADOS EN ISO 20345:2011 - EN ISO 20347:2012

CONFORMIDADE COM A NORMA EN ISO 20345:2011

A norma especifica requisitos básicos e adicionais (opcionais) para Calçado de Segurança de utilização geral. Calçado em conformidade com a norma EN ISO 20345:2011 tem marcação "S" (= Segurança), com biqueira resistente a um impacto de 200 Joules.

CONFORMIDADE COM A NORMA EN ISO 20347:2012

A norma especifica requisitos básicos e adicionais (opcionais) para calçado ocupacional não exposto a riscos mecânicos (impacto ou compressão). Calçado em conformidade com a norma EN ISO 20347:2012 tem marcação "O" (= Ocupacional). Possui muitas das características do calçado descrito acima, embora sem biqueira e sem sola intermédia anti-perfuração.

Tal como no caso dos requisitos básicos para a norma EN ISO 20345:2011, o calçado também pode cumprir alguns requisitos adicionais, que devem ser identificados com símbolos ou classes mencionados na etiqueta que se encontra na língua do sapato.

NORMAS EUROPEIAS E SIGNIFICADOS EN ISO 20345:2022 - EN ISO 20347:2022

CONFORMIDADE COM A NORMA EN ISO 20345:2022

A norma especifica requisitos básicos e adicionais (opcionais) para Calçado de Segurança de utilização geral. Calçado em conformidade com a norma EN ISO 20345:2022 tem marcação "S" (= Segurança), com biqueira resistente a um impacto de 200 Joules.

CONFORMIDADE COM A NORMA EN ISO 20347:2022

A norma especifica requisitos básicos e adicionais (opcionais) para calçado ocupacional não exposto a riscos mecânicos (impacto ou compressão). Calçado em conformidade com a norma EN ISO 20347:2022 tem marcação "O" (= Ocupacional). Possui muitas das características do calçado descrito acima, embora sem biqueira e sem sola intermédia anti-perfuração.

Tal como no caso dos requisitos básicos para a norma EN ISO 20345:2011, o calçado também pode cumprir alguns requisitos adicionais, que devem ser identificados com símbolos ou classes mencionados na etiqueta que se encontra na língua do sapato.

Informação relativa a calçado com inserções anti-perfuração

A resistência deste sapato à perfuração foi testada em laboratório, utilizando força e pregos standard. Pregos de diâmetro menor e com maior estática ou cargas dinâmicas estão associados a um maior risco de perfuração. Sob estas circunstâncias, devem considerar-se medidas de prevenção adicionais. O calçado PPE está disponível com três diferentes tipos de inserções anti-perfuração. Estas podem ser metálicas ou não-metálicas e devem ser escolhidas em função dos riscos associados ao tipo de trabalho. Todos os três tipos de inserções garantem proteção contra o risco de perfuração; contudo, cada uma tem as suas vantagens e desvantagens, nomeadamente:

- **Inserção metálica anti-perfuração:** a resistência à perfuração é menos afetada pelo formato do objeto (ex.: diâmetro, geometria, ponta aguçada), mas não cobre toda a superfície da parte inferior do sapato, devido a limitações nas dimensões necessárias para o fabrico do calçado.
- **Inserção não metálica anti-perfuração:** leve, flexível e com uma ampla cobertura em comparação com a inserção metálica, mas a resistência à perfuração pode variar em função do formato do objeto afiado (ex.: diâmetro, geometria, ponta aguçada).

Modelos PS proporcionam maior proteção contra objetos menores em diâmetro do que os modelos PL.

EN ISO 20345:2011 - EN ISO 20347:2012

REQUISITOS BÁSICOS + REQUISITOS ADICIONAIS PARA CALÇADO

CLASSIFICAÇÃO DE CALÇADO

- **Classe I:** calçado em couro e outros materiais, excluindo totalmente em borracha e em polímero.
- **Classe II:** calçado totalmente em borracha (i.e. inteiramente vulcanizada) ou em polímero (i.e. inteiramente moldado).

REQUISITOS BÁSICOS

- **Todo o calçado:** altura parte superior; zona do calcanhar; desempenho construtivo da sola (construção e resistência de união parte superior/sola); proteção dos dedos e propriedades da biqueira (exceto para calçado abrangido pela EN ISO 20347), resistência antiderrapante.
- **Parte superior:** propriedades dos materiais da parte superior, forro, língua, palmilha/revestimento interior (resistência a rasgões e abrasão, propriedades de tração, permeabilidade a vapor de água, pH, absorção e desabsorção da palmilha/base do pé).
- **Sola exterior:** construção e resistência a rasgões, à abrasão, à flexão, à hidrólise, força de união entre camadas e resistência a óleos de hidrocarbonetos.

CLASSE DE PROTEÇÃO	EN ISO 20345:2011				EN ISO 20347:2012				EN ISO 20345:2011		EN ISO 20347:2012		VALORES MÍNIMOS	
	SB	S1	S2	S3	OB	O1	O2	O3	S4	S5	O4	O5		
	Área do calcanhar fechada	0	X	X	X	0	X	X	X	X	X	X	X	
	Biqueira resistente a um impacto de 200 Joules	X	X	X	X	-	-	-	-	X	X	-	-	
A	Calçado antiestático	0	X	X	X	0	X	X	X	X	X	X	X	Resistência elétrica > 100 kΩ ≤ 1000 kΩ
E	Absorção de energia na área do calcanhar	0	X	X	X	0	X	X	X	X	X	X	X	> 20 Joules
WRU	Parte superior impermeável	0	-	X	X	0	-	X	X	-	-	-	-	Penetração: <0.2 g x 60 min Absorção: <30% x 60 min.
P	Resistência à perfuração (insert metálico P)	0	0	-	X	0	0	-	X	0	X	0	X	> 1100 N
CI	Isolamento contra o frio da palmilha	0	0	0	0	0	0	0	0	0	0	0	0	Descida de temperatura ≤ 10 °C num ambiente a 17 °C durante 30'
HI	Isolamento térmico da palmilha	0	0	0	0	0	0	0	0	0	0	0	0	Aumento de temperatura ≤ 22 °C quando colocado numa placa a uma temperatura de 150 °C durante 30'
HRO	Resistência ao contacto com superfícies quentes	0	0	0	0	0	0	0	0	0	0	0	0	Contacto a 300 °C durante 60" - Não derrete
WR	Impermeável	0	0	0	0	0	0	0	0	-	-	-	-	Sem penetração de água
FO	Resistência a hidrocarbonetos	0	X	X	X	0	0	0	0	X	X	0	0	Aumento de volume da única amostra < 12 %
SRC	Sola antiderrapante	X	X	X	X	X	X	X	X					Requisito SRA + SRB

X	Requisito obrigatório para classe de proteção
O	Requisito opcional acrescentado aos obrigatórios, caso identificado
-	Requisito não obrigatório , verificar informação no sapato

Calçado antiestático:

O calçado antiestático deve ser usado quando existe a necessidade de minimizar a acumulação de cargas electrostáticas, de forma a eliminar o perigo de combustão de substâncias e vapores inflamáveis e em caso de persistência do risco de choque elétrico de componentes sob tensão. O calçado antiestático não protege contra choques elétricos, limitando-se a criar uma resistência elétrica entre o chão e o pé. Se o perigo de choque elétrico não puder ser totalmente eliminado, devem tomar-se medidas de precaução adicionais como parte do plano de prevenção de acidentes no local de trabalho. Para assegurar que são cumpridos os requisitos antiestáticos, o calçado não pode ser objeto de modificações.

Calçado isolante:

O calçado isolante proporciona proteção contra contactos acidentais com componentes elétricos com voltagens até 1000 V, desde que as condições de utilização não interfiram ou alterem a resistência elétrica sob influência de humidade. Salientamos que a resistência elétrica refere-se apenas à parte inferior do calçado, e não à superior.

Classes elétricas para calçado:

Classe 00 500V CA ou 750V CC

Classe 0 1000V CA ou 1500V CC

Calçado de dissipação para ambientes EPA:

Calçado de dissipação, especialmente desenvolvido para ambientes EPA (ESDS), que permite a dissipação de cargas electrostáticas do corpo do operador de forma contínua e controlada, protegendo componentes e dispositivos eletrónicos do fenómeno electrostático. O valor de referência da resistência do solo de acordo com a norma CEI EN 61340-5-1: 2016, para utilizador/calçado/pavimento, é <1 × 10⁹ Ω.

EN ISO 20345:2022 - EN ISO 20347:2022

REQUISITOS BÁSICOS + REQUISITOS ADICIONAIS PARA CALÇADO

CLASSIFICAÇÃO DE CALÇADO

- **Classe I:** calçado em couro e outros materiais, excluindo totalmente em borracha e em polímero.
- **Classe II:** calçado totalmente em borracha (i.e. inteiramente vulcanizada) ou em polímero (i.e. inteiramente moldado).

REQUISITOS BÁSICOS

- **Todo o calçado:** altura parte superior; zona do calcanhar; desempenho construtivo da sola (construção e resistência de união parte superior/sola); proteção dos dedos e propriedades da biqueira (exceto para calçado abrangido pela EN ISO 20347), resistência antiderrapante.
- **Parte superior:** propriedades dos materiais da parte superior, forro, língua, palmilha/revestimento interior (resistência a rasgões e abrasão, propriedades de tração, permeabilidade a vapor de água, pH, absorção e desabsorção da palmilha/base do pé).
- **Sola exterior:** construção e resistência a rasgões, à abrasão, à flexão, à hidrólise, força de união entre camadas e resistência a óleos de hidrocarbonetos.

CLASSE DE PROTEÇÃO	EN ISO 20345:2022											EN ISO 20347:2022						VALORES MÍNIMOS
	SB	S1	S2	S3	S3L	S3S	S6	S7	S7L	S7S	OB	O1	O2	O3	O3L	O3S		
Classe	I o II	I	I	I	I	I	I	I	I	I	I o II	I	I	I	I	I		
Área do calcanhar fechada	0	X	X	X	X	X	X	X	X	X	0	X	X	X	X	X		
Biqueira resistente a um impacto de 200 Joules	X	X	X	X	X	X	X	X	X	X	-	-	-	-	-	-		
Sola com rasto	0	0	0	X	X	X	0	X	X	X	0	0	0	X	X	X		
P Resistência à perfuração (insert metálico P)	0	0	0	X	-	-	0	X	-	-	0	0	0	X	-	-	Força de perfuração ≥ 1100N	
PL Resistência à perfuração (insert não-metálico, teste com prego, Ø 4.5 mm)	0	0	0	-	X	-	0	-	X	-	0	0	0	-	X	-		
PS Resistência à perfuração (insert não-metálico, teste com prego, Ø 3.0 mm)	0	0	0	-	-	X	0	-	-	X	0	0	0	-	-	X		
A Calçado antiestático	0	X	X	X	X	X	X	X	X	X	0	X	X	X	X	X	Resistência elétrica > 100 kΩ ≤ 1000 kΩ	
HI Isolamento térmico da palmilha	0	0	0	0	0	0	0	0	0	0	0	0	0	0	0	0	Aumento de temperatura ≤ 22 °C quando colocado numa placa a uma temperatura de 150 °C durante 30'	
CI Isolamento contra o frio da palmilha	0	0	0	0	0	0	0	0	0	0	0	0	0	0	0	0	Descida de temperatura ≤ 10 °C num ambiente a 17 °C durante 30'	
E Absorção de energia na área do calcanhar	0	X	X	X	X	X	X	X	X	X	0	X	X	X	X	X	> 20 Joules	
WR Impermeável	0	0	0	0	0	0	X	X	X	X	0	0	0	0	0	0	Sem penetração de água	
SC Resistência à abrasão da capa de proteção	0	0	0	0	0	0	0	0	0	0	0	0	0	0	0	0	Nenhum furo em toda a espessura após 8.000 ciclos	
SR Antiderrapante em piso cerâmico com glicerina	X	X	X	X	X	X	X	X	X	X	X	X	X	X	X	X	Teste em piso cerâmico com glicerina	
WPA Penetração e absorção de água	0	0	X	X	X	X	-	-	-	-	0	0	X	X	X	X	Absorção de água após 60' ≤ 30%	
HRO Resistência ao contacto com superfícies quentes	0	0	0	0	0	0	0	0	0	0	0	0	0	0	0	0	Contacto a 300 °C durante 60" - Não derrete	
FO Resistência a hidrocarbonetos	0	0	0	0	0	0	0	0	0	0	0	0	0	0	0	0	Aumento de volume da única amostra < 12 %	
LG Ranhura de segurança para escada	0	0	0	0	0	0	0	0	0	0	0	0	0	0	0	0	Largura da área central da sola > 35 mm	

X	Requisito obrigatório para classe de proteção
O	Requisito opcional acrescentado aos obrigatórios, caso identificado
-	Requisito não obrigatório , verificar informação no sapato

Calçado parcialmente condutor

O calçado parcialmente condutor deve ser utilizado se for necessário minimizar as cargas electrostáticas no menor tempo possível, por exemplo, ao manusear explosivos.

O calçado eletricamente condutivo não deve ser utilizado se o risco de choque de qualquer aparelho elétrico ou componentes sob tensão alternada ou direta não tiver sido completamente eliminado. A fim de assegurar que este calçado é parcialmente condutor, foi especificado um limite superior de resistência de 100 kΩ em estado novo.

Calçado antiestático:



O calçado antiestático deve ser usado quando existe a necessidade de minimizar a acumulação de cargas electrostáticas, de forma a eliminar o perigo de combustão de substâncias e vapores inflamáveis e em caso de persistência do risco de choque elétrico de componentes sob tensão. O calçado antiestático não protege contra choques elétricos, limitando-se a criar uma resistência elétrica entre o chão e o pé. Se o perigo de choque elétrico não puder ser totalmente eliminado, devem tomar-se medidas de precaução adicionais como parte do plano de prevenção de acidentes no local de trabalho. Para assegurar que são cumpridos os requisitos antiestáticos, o calçado não pode ser objeto de modificações.

Os certificados de calçado em conformidade com normas anteriores mantêm-se válidos até ao seu termo

EN ISO 20345:2011		S1P SRC										
LINHA	ITEM	REQUISITOS			SETORES RECOMENDADOS							📄
		REQUISITOS ADICIONAIS		METAL FREE 	SETOR AUTO	CONSTRUÇÃO	ELETRICIDADE	INDÚSTRIA	LOGÍSTICA	AQUECIMENTO/CAVALHAZÕES		
 FLEX	7212G	ESD		X	X	X	X	X	X	X	X	635
	7212B	ESD		X	X	X	X	X	X	X	X	634
	7213G	ESD		X	X	X	X	X	X	X	X	635
 EASY PLUS	7222PEK			X	X	X	X	X	X	X	X	633
	7223PEK			X	X	X	X	X	X	X	X	633
 BASIC	7241BK				X	X	X	X	X	X	X	630
	7243BK				X	X	X	X	X	X	X	630
	7246BK				X	X	X	X	X	X	X	632
	7247BK				X	X	X	X	X	X	X	632
 EASY	7246E				X	X	X	X	X	X	X	629
 TREKKING	7249GK	RS			X	X	X	X	X	X	X	638
 ACTIVE	7314AF			X	X	X	X	X	X	X	X	639
	7316NB	ESD		X	X	X	X	X	X	X	X	639
	7316NG	ESD		X	X	X	X	X	X	X	X	640
	7317NA			X	X	X	X	X	X	X	X	640
 0-GRAVITY	7352A	HRO		X	X	X	X	X	X	X	X	642
	7352B	HRO		X	X	X	X	X	X	X	X	642
	7352G	HRO ESD	X	X	X	X	X	X	X	X	X	642
	7353Y	HRO		X	X	X	X	X	X	X	X	643
	7372B	HRO	X	X	X	X	X	X	X	X	X	646
7376A	HRO	X	X	X	X	X	X	X	X	X	646	
 0-GRAVITY LADY	7352LG	HRO		X	X	X	X	X	X	X	X	643

EN ISO 20347:2012		O1 SRC										
 0-GRAVITY	7362B	FO HRO		X	X	X	X	X	X	X	X	645

EN ISO 20345:2022		S1PS SR										
 0-GRAVITY	7371V	HRO FO ESD	X	X	X	X	X	X	X	X	X	645

EN ISO 20347:2012		O2 SRC										
 BASIC	7243FT	FO			X	X	X	X	X	X	X	631
 0-GRAVITY	7363N	FO HRO		X	X	X	X	X	X	X	X	645

EN ISO 20345:2011		S3 SRC										
LINE	ITEM	REQUISITOS			SETORES RECOMENDADOS							📄
		REQUISITOS ADICIONAIS		METAL FREE 	AGRICULTURA	SETOR AUTO	CONSTRUÇÃO	INDÚSTRIA	ELETRICIDADE	LOGÍSTICA	INDÚSTRIA	
 FLEX	7214FN			X	X	X	X	X	X	X	X	635
	7214G	ESD		X	X	X	X	X	X	X	X	636
	7215FN			X	X	X	X	X	X	X	X	636
	7218FN	RS		X	X	X	X	X	X	X	X	636
	7218G	RS ESD		X	X	X	X	X	X	X	X	636
 EASY PLUS	7220PEK			X	X	X	X	X	X	X	X	633
	7221PEK	RS		X	X	X	X	X	X	X	X	633
 TREKKING	7236BK	RS			X	X	X	X	X	X	X	638
	7238WR	RS HRO WR			X	X	X	X	X	X	X	638
 EASY	7241EN				X	X	X	X	X	X	X	629
	7243EN	RS			X	X	X	X	X	X	X	629
 BASIC	7241CK				X	X	X	X	X	X	X	630
	7243CK	RS			X	X	X	X	X	X	X	631
	7243CR	RS HRO			X	X	X	X	X	X	X	631
7245BK	RS			X	X	X	X	X	X	X	631	
 HEAVY DUTY	7293HM	HRO HI	X		X	X	X	X	X	X	X	647
	7294HM	HRO HI	X		X	X	X	X	X	X	X	647
	7294HMC	HRO HI CI WR	X		X	X	X	X	X	X	X	647
 ACTIVE	7315AN			X	X	X	X	X	X	X	X	639
	7318AN			X	X	X	X	X	X	X	X	640
	7320NA			X	X	X	X	X	X	X	X	640
	7321NA	RS		X	X	X	X	X	X	X	X	641
	7322SA			X	X	X	X	X	X	X	X	641
	7323SA	RS		X	X	X	X	X	X	X	X	641
 0-GRAVITY	7354N	HRO		X	X	X	X	X	X	X	X	643
	7355V	HRO		X	X	X	X	X	X	X	X	643
	7356G	HRO		X	X	X	X	X	X	X	X	644
	7357G	HRO		X	X	X	X	X	X	X	X	644
	7356V	HRO		X	X	X	X	X	X	X	X	644
7357V	HRO		X	X	X	X	X	X	X	X	645	
 0-GRAVITY LADY	7356LN	HRO		X	X	X	X	X	X	X	X	644
 0-GRAVITY	7381N	HRO WR	X	X	X	X	X	X	X	X	X	646
	7382N	HRO WR	X	X	X	X	X	X	X	X	X	646

EN ISO 20345:2011		S5 SRC										
 BASIC	7328A				X	X	X	X	X	X	X	632
	7328N				X	X	X	X	X	X	X	632

EASY



7241EN

Sapato em pele natural, impermeável

- Biqueira de aço
- Palmilha anti-perfuração elástica à prova de aço

**EN ISO
20345
2011**



EU	UK	mm	€		
35	2,5	230	43,50	1	072410835
36	3,5	237	43,50	1	072410836
37	4,5	244	43,50	1	072410837
38	5	250	43,50	1	072410838
39	6	257	43,50	1	072410839
40	6,5	264	43,50	1	072410840
41	7	270	43,50	1	072410841
42	8	277	43,50	1	072410842
43	9	284	43,50	1	072410843
44	10	290	43,50	1	072410844
45	10,5	297	43,50	1	072410845
46	11	304	43,50	1	072410846
47	12	310	43,50	1	072410847
48	13	317	43,50	1	072410848



CE

S3 SRC

7243EN

Bota em pele natural, impermeável, com sistema de abertura rápida

- Biqueira de aço
- Palmilha anti-perfuração elástica à prova de aço

**EN ISO
20345
2011**



EU	UK	mm	€		
35	2,5	230	44,50	1	072430835
36	3,5	237	44,50	1	072430836
37	4,5	244	44,50	1	072430837
38	5	250	44,50	1	072430838
39	6	257	44,50	1	072430839
40	6,5	264	44,50	1	072430840
41	7	270	44,50	1	072430841
42	8	277	44,50	1	072430842
43	9	284	44,50	1	072430843
44	10	290	44,50	1	072430844
45	10,5	297	44,50	1	072430845
46	11	304	44,50	1	072430846
47	12	310	44,50	1	072430847
48	13	317	44,50	1	072430848



CE

S3 RS SRC

7246E

Sapato aberto, de carmuça

- Biqueira de aço
- Palmilha anti-perfuração em aço flexível

**EN ISO
20345
2011**



EU	UK	mm	€		
35	2,5	230	44,50	1	072460435
36	3,5	237	44,50	1	072460436
37	4,5	244	44,50	1	072460437
38	5	250	44,50	1	072460438
39	6	257	44,50	1	072460439
40	6,5	264	44,50	1	072460440
41	7	270	44,50	1	072460441
42	8	277	44,50	1	072460442
43	9	284	44,50	1	072460443
44	10	290	44,50	1	072460444
45	10,5	297	44,50	1	072460445
46	11	304	44,50	1	072460446
47	12	310	44,50	1	072460447
48	13	317	44,50	1	072460448



CE

S1P SRC

BASIC



7241BK

Sapato em pele natural

- Biqueira de aço
- Palmilha anti-perfuração em fibra reforçada

EU	UK	mm	€	W	W
35	2,5	228	52,50	1	072411235
36	3,5	235	52,50	1	072411236
37	4,5	242	52,50	1	072411237
38	5	248	52,50	1	072411238
39	6	255	52,50	1	072411239
40	6,5	262	52,50	1	072411240
41	7	268	52,50	1	072411241
42	8	275	52,50	1	072411242
43	9	282	52,50	1	072411243
44	10	288	52,50	1	072411244
45	10,5	295	52,50	1	072411245
46	11	302	52,50	1	072411246
47	12	308	52,50	1	072411247
48	13	315	52,50	1	072411248



CE

S1P SRC

**EN ISO
20345
2011**



7241CK

Sapato em pele natural, impermeável

- Biqueira de aço
- Palmilha anti-perfuração em fibra reforçada

EU	UK	mm	€	W	W
35	2,5	228	53,50	1	072411535
36	3,5	235	53,50	1	072411536
37	4,5	242	53,50	1	072411537
38	5	248	53,50	1	072411538
39	6	255	53,50	1	072411539
40	6,5	262	53,50	1	072411540
41	7	268	53,50	1	072411541
42	8	275	53,50	1	072411542
43	9	282	53,50	1	072411543
44	10	288	53,50	1	072411544
45	10,5	295	53,50	1	072411545
46	11	302	53,50	1	072411546
47	12	308	53,50	1	072411547
48	13	315	53,50	1	072411548



CE

S3 SRC

**EN ISO
20345
2011**



7243BK

Bota em pele natural

- Biqueira de aço
- Palmilha anti-perfuração em fibra reforçada

EU	UK	mm	€	W	W
35	2,5	228	53,50	1	072431235
36	3,5	235	53,50	1	072431236
37	4,5	242	53,50	1	072431237
38	5	248	53,50	1	072431238
39	6	255	53,50	1	072431239
40	6,5	262	53,50	1	072431240
41	7	268	53,50	1	072431241
42	8	275	53,50	1	072431242
43	9	282	53,50	1	072431243
44	10	288	53,50	1	072431244
45	10,5	295	53,50	1	072431245
46	11	302	53,50	1	072431246
47	12	308	53,50	1	072431247
48	13	315	53,50	1	072431248



CE

S1P SRC

**EN ISO
20345
2011**



7243CK

Bota em pele natural, com atacadores, impermeável, sistema de abertura rápida

- Biqueira de aço
- Palmilha anti-perfuração em fibra reforçada

EU	UK	mm	€	W	PC
35	2,5	228	55,50	1	072431335
36	3,5	235	55,50	1	072431336
37	4,5	242	55,50	1	072431337
38	5	248	55,50	1	072431338
39	6	255	55,50	1	072431339
40	6,5	262	55,50	1	072431340
41	7	268	55,50	1	072431341
42	8	275	55,50	1	072431342
43	9	282	55,50	1	072431343
44	10	288	55,50	1	072431344
45	10,5	295	55,50	1	072431345
46	11	302	55,50	1	072431346
47	12	308	55,50	1	072431347
48	13	315	55,50	1	072431348

CE



S3 RS SRC

EN ISO 20345 2011



7243CR

botim em pele, impermeável, com sola em borracha durável e sistema de abertura rápida

- Biqueira em aço
- Sola intermédia anti-perfuração em aço

EU	UK	mm	€	W	PC
35	2,5	231	81,50	1	072430735
36	3,5	238	81,50	1	072430736
37	4,5	245	81,50	1	072430737
38	5	251	81,50	1	072430738
39	6	258	81,50	1	072430739
40	6,5	265	81,50	1	072430740
41	7	271	81,50	1	072430741
42	8	278	81,50	1	072430742
43	9	285	81,50	1	072430743
44	10	291	81,50	1	072430744
45	10,5	298	81,50	1	072430745
46	11	305	81,50	1	072430746
47	12	311	81,50	1	072430747
48	13	318	81,50	1	072430748

CE



S3 RS HRO SRC

EN ISO 20345 2011



7243FT

botins em pele, impermeáveis, sem biqueira, sem palmilha reforçada

- Sem biqueira reforçada
- Sem palmilha reforçada

EU	UK	mm	€	W	PC
35	2,5	228	48,00	1	072430635
36	3,5	235	48,00	1	072430636
37	4,5	242	48,00	1	072430637
38	5	248	48,00	1	072430638
39	6	255	48,00	1	072430639
40	6,5	262	48,00	1	072430640
41	7	268	48,00	1	072430641
42	8	275	48,00	1	072430642
43	9	282	48,00	1	072430643
44	10	288	48,00	1	072430644
45	10,5	295	48,00	1	072430645
46	11	302	48,00	1	072430646
47	12	308	48,00	1	072430647
48	13	315	48,00	1	072430648

CE



O2 FO SRC

EN ISO 20347 2012



7245BK

Bota em pele natural, com atacadores, impermeável, sistema de abertura rápida com velcro e biqueira de proteção.

- Biqueira de aço
- Palmilha anti-perfuração em fibra reforçada

EU	UK	mm	€	W	PC
35	2,5	228	63,50	1	072451235
36	3,5	235	63,50	1	072451236
37	4,5	242	63,50	1	072451237
38	5	248	63,50	1	072451238
39	6	255	63,50	1	072451239
40	6,5	262	63,50	1	072451240
41	7	268	63,50	1	072451241
42	8	275	63,50	1	072451242
43	9	282	63,50	1	072451243
44	10	288	63,50	1	072451244
45	10,5	295	63,50	1	072451245
46	11	302	63,50	1	072451246
47	12	308	63,50	1	072451247
48	13	315	63,50	1	072451248

CE



S3 RS SRC

EN ISO 20345 2011



7246BK

Sapato aberto, de camuça

- Biqueira de aço
- Palmilha anti-perfuração em fibra reforçada

EU	UK	mm	€	U	U
35	2,5	228	55,50	1	072461235
36	3,5	235	55,50	1	072461236
37	4,5	242	55,50	1	072461237
38	5	248	55,50	1	072461238
39	6	255	55,50	1	072461239
40	6,5	262	55,50	1	072461240
41	7	268	55,50	1	072461241
42	8	275	55,50	1	072461242
43	9	282	55,50	1	072461243
44	10	288	55,50	1	072461244
45	10,5	295	55,50	1	072461245
46	11	302	55,50	1	072461246
47	12	308	55,50	1	072461247
48	13	315	55,50	1	072461248

CE



S1P SRC

EN ISO 20345 2011



7247BK

Sapato aberto, em pele natural

- Biqueira de aço
- Palmilha anti-perfuração em fibra reforçada

EU	UK	mm	€	U	U
35	2,5	228	54,50	1	072471235
36	3,5	235	54,50	1	072471236
37	4,5	242	54,50	1	072471237
38	5	248	54,50	1	072471238
39	6	255	54,50	1	072471239
40	6,5	262	54,50	1	072471240
41	7	268	54,50	1	072471241
42	8	275	54,50	1	072471242
43	9	282	54,50	1	072471243
44	10	288	54,50	1	072471244
45	10,5	295	54,50	1	072471245
46	11	302	54,50	1	072471246
47	12	308	54,50	1	072471247
48	13	315	54,50	1	072471248

CE



S1P SRC

EN ISO 20345 2011



7328A

botas de trabalho "máxima visibilidade" em PVC de nitrilo. Com rasto antiderrapante.

- Biqueira de aço
- Palmilha anti-perfuração

EU	UK	mm	€	U	U
38	5	253	43,00	1	073280638
39	6	260	43,00	1	073280639
40	6,5	267	43,00	1	073280640
41	7	273	43,00	1	073280641
42	8	280	43,00	1	073280642
43	9	287	43,00	1	073280643
44	10	293	43,00	1	073280644
45	10,5	300	43,00	1	073280645
46	11	307	43,00	1	073280646
47	12	313	43,00	1	073280647

CE



S5 SRC

EN ISO 20345 2011



7328N

botas de trabalho em PVC de nitrilo. Com rasto antiderrapante.

- Biqueira de aço
- Palmilha anti-perfuração

EU	UK	mm	€	U	U
38	5	253	43,00	1	073280838
39	6	260	43,00	1	073280839
40	6,5	267	43,00	1	073280840
41	7	273	43,00	1	073280841
42	8	280	43,00	1	073280842
43	9	287	43,00	1	073280843
44	10	293	43,00	1	073280844
45	10,5	300	43,00	1	073280845
46	11	307	43,00	1	073280846
47	12	313	43,00	1	073280847

CE



S5 SRC

EN ISO 20345 2011



EASY PLUS



7220PEK

Sapato em pele, impermeável, com aplicações de nylon, biqueira com reforço anti-abrasão

- Biqueira em compósito
- Palmilha anti-perfuração em fibra reforçada

EU	UK	mm	€	W	Art.
35	2,5	228	72,50	1	072200235
36	3,5	235	72,50	1	072200236
37	4,5	242	72,50	1	072200237
38	5	248	72,50	1	072200238
39	6	255	72,50	1	072200239
40	6,5	262	72,50	1	072200240
41	7	268	72,50	1	072200241
42	8	275	72,50	1	072200242
43	9	282	72,50	1	072200243
44	10	288	72,50	1	072200244
45	10,5	295	72,50	1	072200245
46	11	302	72,50	1	072200246
47	12	308	72,50	1	072200247
48	13	315	72,50	1	072200248

CE



S3 SRC

EN ISO
20345
2011

METAL
FREE



7221PEK

Botim em pele, impermeável, com aplicações de nylon, biqueira com reforço anti-abrasão e sistema de abertura rápida

- Biqueira em compósito
- Palmilha anti-perfuração em fibra reforçada

EU	UK	mm	€	W	Art.
35	2,5	228	76,00	1	072210235
36	3,5	235	76,00	1	072210236
37	4,5	242	76,00	1	072210237
38	5	248	76,00	1	072210238
39	6	255	76,00	1	072210239
40	6,5	262	76,00	1	072210240
41	7	268	76,00	1	072210241
42	8	275	76,00	1	072210242
43	9	282	76,00	1	072210243
44	10	288	76,00	1	072210244
45	10,5	295	76,00	1	072210245
46	11	302	76,00	1	072210246
47	12	308	76,00	1	072210247
48	13	315	76,00	1	072210248

CE



S3 RS SRC

EN ISO
20345
2011

METAL
FREE



7222PEK

sapato em camurça, perfurado, com inserts de rede

- Biqueira em compósito
- Palmilha anti-perfuração em fibra compósita

EU	UK	mm	€	W	Art.
35	2,5	228	70,00	1	072220135
36	3,5	235	70,00	1	072220136
37	4,5	242	70,00	1	072220137
38	5	248	70,00	1	072220138
39	6	255	70,00	1	072220139
40	6,5	262	70,00	1	072220140
41	7	268	70,00	1	072220141
42	8	275	70,00	1	072220142
43	9	282	70,00	1	072220143
44	10	288	70,00	1	072220144
45	10,5	295	70,00	1	072220145
46	11	302	70,00	1	072220146
47	12	308	70,00	1	072220147
48	13	315	70,00	1	072220148

CE



S1P SRC

EN ISO
20345
2011

METAL
FREE



7223PEK

Sapato de camurça com aberturas em rede e biqueira com reforço anti-abrasão

- Biqueira em compósito
- Palmilha anti-perfuração em fibra reforçada

EU	UK	mm	€	W	mm
35	2,5	228	75,50	1	072230135
36	3,5	235	75,50	1	072230136
37	4,5	242	75,50	1	072230137
38	5	248	75,50	1	072230138
39	6	255	75,50	1	072230139
40	6,5	262	75,50	1	072230140
41	7	268	75,50	1	072230141
42	8	275	75,50	1	072230142
43	9	282	75,50	1	072230143
44	10	288	75,50	1	072230144
45	10,5	295	75,50	1	072230145
46	11	302	75,50	1	072230146
47	12	308	75,50	1	072230147
48	13	315	75,50	1	072230148



CE

S1P SRC

EN ISO 20345 2011



FLEX



7212B

sapato em camurça, perfurado, com inserções em rede, insert anti-abrasão na área da biqueira Extraordinariamente flexível e leve - peso aprox. tamanho 42: 490 g Não recomendado para trabalhos pesados (construção, agricultura, indústria pesada)

- Biqueira em material compósito
- Palmilha anti-perfuração em fibra compósita

EU	UK	mm	€	W	mm
35	2,5	228	81,00	1	072120235
36	3,5	235	81,00	1	072120236
37	4,5	242	81,00	1	072120237
38	5	248	81,00	1	072120238
39	6	255	81,00	1	072120239
40	6,5	262	81,00	1	072120240
41	7	268	81,00	1	072120241
42	8	275	81,00	1	072120242
43	9	282	81,00	1	072120243
44	10	288	81,00	1	072120244
45	10,5	295	81,00	1	072120245
46	11	302	81,00	1	072120246
47	12	308	81,00	1	072120247
48	13	315	81,00	1	072120248



CE

S1P SRC ESD

EN ISO 20345 2011



Beta

7212G

sapatos em camurça, perfurados. Com inserção anti-abrasão na biqueira. Extremamente maleáveis e leves - peso aprox. tamanho 42: 490 g Não recomendados para trabalhos pesados (construção, agricultura, indústria pesada)

- Biqueira em material compósito
- Palmilha anti-perfuração em fibra compósita

EU	UK	mm	€	Art. 1	Art. 2
35	2.5	228	81,00	1 072120335	
36	3.5	235	81,00	1 072120336	
37	4.5	242	81,00	1 072120337	
38	5	248	81,00	1 072120338	
39	6	255	81,00	1 072120339	
40	6.5	262	81,00	1 072120340	
41	7	268	81,00	1 072120341	
42	8	275	81,00	1 072120342	
43	9	282	81,00	1 072120343	
44	10	288	81,00	1 072120344	
45	10.5	295	81,00	1 072120345	
46	11	302	81,00	1 072120346	
47	12	308	81,00	1 072120347	
48	13	315	81,00	1 072120348	

CE



S1P SRC ESD



EN ISO 20345 2011



7213G

sapato em camurça, perfurado, com inserções em rede altamente respiráveis. Extraordinariamente flexíveis e leves - peso aprox. para tamanho 42: 490 g Não recomendado para trabalhos pesados (construção, agricultura, indústria pesada)

- Biqueira em material compósito
- Palmilha anti-perfuração em fibra compósita

EU	UK	mm	€	Art. 1	Art. 2
35	2.5	228	81,00	1 072130135	
36	3.5	235	81,00	1 072130136	
37	4.5	242	81,00	1 072130137	
38	5	248	81,00	1 072130138	
39	6	255	81,00	1 072130139	
40	6.5	262	81,00	1 072130140	
41	7	268	81,00	1 072130141	
42	8	275	81,00	1 072130142	
43	9	282	81,00	1 072130143	
44	10	288	81,00	1 072130144	
45	10.5	295	81,00	1 072130145	
46	11	302	81,00	1 072130146	
47	12	308	81,00	1 072130147	
48	13	315	81,00	1 072130148	

CE



S1P SRC ESD



EN ISO 20345 2011



7214FN

Sapato em pele, impermeável, com proteção anti-abrasão na biqueira, Extremamente leve e flexível - peso aproximado 500g, tamanho 42 Não recomendado para trabalhos pesados (construção, agricultura, indústria)

- Biqueira em compósito
- Sola intermédia antiperfuração em fibra compósita

EU	UK	mm	€	Art. 1	Art. 2
35	2.5	228	87,50	1 072140035	
36	3.5	235	87,50	1 072140036	
37	4.5	242	87,50	1 072140037	
38	5	248	87,50	1 072140038	
39	6	255	87,50	1 072140039	
40	6.5	262	87,50	1 072140040	
41	7	268	87,50	1 072140041	
42	8	275	87,50	1 072140042	
43	9	282	87,50	1 072140043	
44	10	288	87,50	1 072140044	
45	10.5	295	87,50	1 072140045	
46	11	302	87,50	1 072140046	
47	12	308	87,50	1 072140047	
48	13	315	87,50	1 072140048	

CE



S3 SRC



EN ISO 20345 2011



 **Beta**

7214G

sapatos Action em camurça, impermeáveis, com insert anti-abrasão na área da biqueira Extraordinariamente flexíveis e leves -peso aprox. para o tamanho 42: 500 g Não recomendado para trabalhos pesados (construção, agricultura, indústria pesada)

- Biqueira em material compósito
- Palmilha anti-perfuração em fibra compósita

EU	UK	mm	€		
35	2.5	228	87,50	1	072140235
36	3.5	235	87,50	1	072140236
37	4.5	242	87,50	1	072140237
38	5	248	87,50	1	072140238
39	6	255	87,50	1	072140239
40	6.5	262	87,50	1	072140240
41	7	268	87,50	1	072140241
42	8	275	87,50	1	072140242
43	9	282	87,50	1	072140243
44	10	288	87,50	1	072140244
45	10.5	295	87,50	1	072140245
46	11	302	87,50	1	072140246
47	12	308	87,50	1	072140247
48	13	315	87,50	1	072140248

CE



S3 SRC ESD



EN ISO 20345 2011



7215FN

moccasin Action em pele Nubuck, impermeáveis, com aplicação anti-abrasão na biqueira Extremamente leve e flexível - peso aproximado 490g, tamanho 42 Não recomendado para trabalhos pesados (construção, agricultura, indústria)

- Biqueira em material compósito
- Sola intermédia anti-perfuração em fibra compósita

EU	UK	mm	€		
35	2,5	228	88,50	1	072150135
36	3,5	235	88,50	1	072150136
37	4,5	242	88,50	1	072150137
38	5	248	88,50	1	072150138
39	6	255	88,50	1	072150139
40	6,5	262	88,50	1	072150140
41	7	268	88,50	1	072150141
42	8	275	88,50	1	072150142
43	9	282	88,50	1	072150143
44	10	288	88,50	1	072150144
45	10,5	295	88,50	1	072150145
46	11	302	88,50	1	072150146
47	12	308	88,50	1	072150147
48	13	315	88,50	1	072150148

CE



S3 SRC



EN ISO 20345 2011



7218FN

Botim em Nubuck, impermeável, biqueira anti-abrasão e sistema de abertura rápida. Extremamente flexível e leve - peso apróx., tamanho 42: 510g. Não recomendado para trabalhos pesados (ex: construção, agricultura, indústria pesada).

- Biqueira em compósito
- Palmilha anti-perfuração em fibra reforçada

EU	UK	mm	€		
35	2,5	228	91,50	1	072180035
36	3,5	235	91,50	1	072180036
37	4,5	242	91,50	1	072180037
38	5	248	91,50	1	072180038
39	6	255	91,50	1	072180039
40	6,5	262	91,50	1	072180040
41	7	268	91,50	1	072180041
42	8	275	91,50	1	072180042
43	9	282	91,50	1	072180043
44	10	288	91,50	1	072180044
45	10,5	295	91,50	1	072180045
46	11	302	91,50	1	072180046
47	12	308	91,50	1	072180047
48	13	315	91,50	1	072180048

CE



S3 RS SRC



EN ISO 20345 2011



7218G

botins Action em camurça, impermeáveis, com insert anti-abrasão na área da biqueira e sistema de abertura rápida Extraordinariamente flexíveis e leves -peso aprox. para o tamanho 42: 550 g Não recomendado para trabalhos pesados (construção, agricultura, indústria pesada)

- Biqueira em material compósito
- Palmilha anti-perfuração em fibra compósita

EU	UK	mm	€		
35	2.5	228	91,50	1	072180135
36	3.5	235	91,50	1	072180136
37	4.5	242	91,50	1	072180137
38	5	248	91,50	1	072180138
39	6	255	91,50	1	072180139
40	6.5	262	91,50	1	072180140
41	7	268	91,50	1	072180141
42	8	275	91,50	1	072180142
43	9	282	91,50	1	072180143
44	10	288	91,50	1	072180144
45	10.5	295	91,50	1	072180145
46	11	302	91,50	1	072180146
47	12	308	91,50	1	072180147
48	13	315	91,50	1	072180148

CE



S3 RS SRC ESD



EN ISO 20345 2011



BASIC PLUS



7201BKK

botim em pele, impermeável
INDISPONÍVEL PARA VENDA

- biqueira em material compósito
- palmilha em fibra compósita antipenetração

EU	UK	mm	EU	UK	mm
35	2,5	228	1	072010435	
36	3,5	235	1	072010436	
37	4,5	242	1	072010437	
38	5	248	1	072010438	
39	6	255	1	072010439	
40	6,5	262	1	072010440	
41	7	268	1	072010441	
42	8	275	1	072010442	
43	9	282	1	072010443	
44	10	288	1	072010444	
45	10,5	295	1	072010445	
46	11	302	1	072010446	
47	12	308	1	072010447	
48	13	315	1	072010448	



CE

S3 SRC

EN ISO 20345 2011

METAL FREE



7210BKK

sapato em camurça, perfurado
INDISPONÍVEL PARA VENDA

- biqueira em material compósito
- palmilha em fibra compósita antipenetração

EU	UK	mm	EU	UK	mm
35	2,5	228	1	072100335	
36	3,5	235	1	072100336	
37	4,5	242	1	072100337	
38	5	248	1	072100338	
39	6	255	1	072100339	
40	6,5	262	1	072100340	
41	7	268	1	072100341	
42	8	275	1	072100342	
43	9	282	1	072100343	
44	10	288	1	072100344	
45	10,5	295	1	072100345	
46	11	302	1	072100346	
47	12	308	1	072100347	
48	13	315	1	072100348	



CE

S1P SRC

EN ISO 20345 2011

METAL FREE



7216BKK

sandália em camurça,
com presilha
INDISPONÍVEL PARA VENDA

- biqueira em material compósito
- palmilha em fibra compósita antipenetração

EU	UK	mm	EU	UK	mm
35	2,5	228	1	072160335	
36	3,5	235	1	072160336	
37	4,5	242	1	072160337	
38	5	248	1	072160338	
39	6	255	1	072160339	
40	6,5	262	1	072160340	
41	7	268	1	072160341	
42	8	275	1	072160342	
43	9	282	1	072160343	
44	10	288	1	072160344	
45	10,5	295	1	072160345	
46	11	302	1	072160346	
47	12	308	1	072160347	
48	13	315	1	072160348	



CE

S1P SRC

EN ISO 20345 2011

METAL FREE



TREKKING



7236BK

botim Action em pele Nubuck, impermeável, com sistema de abertura rápida e biqueira reforçada em poliuretano

- Biqueira em aço
- Palmilha anti-perfuração em fibra compósita

EU	UK	mm	€		
35	2,5	228	83,00	1	072360335
36	3,5	235	83,00	1	072360336
37	4,5	242	83,00	1	072360337
38	5	248	83,00	1	072360338
39	6	255	83,00	1	072360339
40	6,5	262	83,00	1	072360340
41	7	268	83,00	1	072360341
42	8	275	83,00	1	072360342
43	9	282	83,00	1	072360343
44	10	288	83,00	1	072360344
45	10,5	295	83,00	1	072360345
46	11	302	83,00	1	072360346
47	12	308	83,00	1	072360347
48	13	315	83,00	1	072360348



CE

S3 RS SRC

**EN ISO
20345
2011**



7238WR

sapatos com aplicações em nylon, sola exterior resistente em borracha, com sistema de abertura rápida WR (calçado impermeável): após 1.000 passos num reservatório com 3 cm de água, a superfície interna molhada é ≤ 3 cm²

- Biqueira em material composto
- Palmilha anti-perfuração em fibra compósita

EU	UK	mm	€		
35	2,5	228	112,00	1	072380235
36	3,5	235	112,00	1	072380236
37	4,5	242	112,00	1	072380237
38	5	248	112,00	1	072380238
39	6	255	112,00	1	072380239
40	6,5	262	112,00	1	072380240
41	7	268	112,00	1	072380241
42	8	275	112,00	1	072380242
43	9	282	112,00	1	072380243
44	10	288	112,00	1	072380244
45	10,5	295	112,00	1	072380245
46	11	302	112,00	1	072380246
47	12	308	112,00	1	072380247
48	13	315	112,00	1	072380248



CE

S3 RS WR HRO SRC

**EN ISO
20345
2011**



7249GK

botim em camurça com aplicações em nylon, com sistema de abertura rápida e biqueira reforçada em poliuretano

- Biqueira em aço
- Palmilha anti-perfuração em fibra compósita

EU	UK	mm	€		
35	2,5	231	70,00	1	072490235
36	3,5	238	70,00	1	072490236
37	4,5	245	70,00	1	072490237
38	5	251	70,00	1	072490238
39	6	258	70,00	1	072490239
40	6,5	265	70,00	1	072490240
41	7	271	70,00	1	072490241
42	8	278	70,00	1	072490242
43	9	285	70,00	1	072490243
44	10	291	70,00	1	072490244
45	10,5	298	70,00	1	072490245
46	11	305	70,00	1	072490246
47	12	311	70,00	1	072490247
48	13	318	70,00	1	072490248



CE

S1P RS SRC

**EN ISO
20345
2011**



ACTIVE



7314AF

sapato em camurça
com aplicações de nylon e inserções em carbono

- Biqueira em material compósito
- Palmilha em fibra anti-perfuração

**EN ISO
20345
2011**

METAL
FREE



EU	UK	mm	€	W	W
35	2,5	228	111,00	1	073140235
36	3,5	235	111,00	1	073140236
37	4,5	242	111,00	1	073140237
38	5	248	111,00	1	073140238
39	6	255	111,00	1	073140239
40	6,5	262	111,00	1	073140240
41	7	268	111,00	1	073140241
42	8	275	111,00	1	073140242
43	9	282	111,00	1	073140243
44	10	288	111,00	1	073140244
45	10,5	295	111,00	1	073140245
46	11	302	111,00	1	073140246
47	12	308	111,00	1	073140247
48	13	315	111,00	1	073140248



CE

S1P SRC

7315AN

sapato em camurça e microfibras,
impermeável, com inserções em carbono

- Biqueira em material compósito
- Palmilha em fibra anti-perfuração

**EN ISO
20345
2011**

METAL
FREE



EU	UK	mm	€	W	W
35	2,5	228	128,00	1	073150535
36	3,5	235	128,00	1	073150536
37	4,5	242	128,00	1	073150537
38	5	248	128,00	1	073150538
39	6	255	128,00	1	073150539
40	6,5	262	128,00	1	073150540
41	7	268	128,00	1	073150541
42	8	275	128,00	1	073150542
43	9	282	128,00	1	073150543
44	10	288	128,00	1	073150544
45	10,5	295	128,00	1	073150545
46	11	302	128,00	1	073150546
47	12	308	128,00	1	073150547
48	13	315	128,00	1	073150548



CE

S3 SRC

7316NB

sapato em camurça e rede, altamente respirável,
com apoio de estabilidade no calcanhar

- Biqueira em compósito
- Palmilha anti-perfuração em fibra compósita

**EN ISO
20345
2011**



METAL
FREE



EU	UK	mm	€	W	W
35	2,5	228	96,00	1	073160735
36	3,5	235	96,00	1	073160736
37	4,5	242	96,00	1	073160737
38	5	248	96,00	1	073160738
39	6	255	96,00	1	073160739
40	6,5	262	96,00	1	073160740
41	7	268	96,00	1	073160741
42	8	275	96,00	1	073160742
43	9	282	96,00	1	073160743
44	10	288	96,00	1	073160744
45	10,5	295	96,00	1	073160745
46	11	302	96,00	1	073160746
47	12	308	96,00	1	073160747
48	13	315	96,00	1	073160748



CE

S1P SRC ESD

7316NG

sapato em camurça e rede, altamente respirável, com apoio de estabilidade no calcanhar

- Biqueira em compósito
- Palmilha anti-perfuração em fibra compósita

EU	UK	mm	€	U	U
35	2.5	228	96,00	1	073160635
36	3.5	235	96,00	1	073160636
37	4.5	242	96,00	1	073160637
38	5	248	96,00	1	073160638
39	6	255	96,00	1	073160639
40	6.5	262	96,00	1	073160640
41	7	268	96,00	1	073160641
42	8	275	96,00	1	073160642
43	9	282	96,00	1	073160643
44	10	288	96,00	1	073160644
45	10.5	295	96,00	1	073160645
46	11	302	96,00	1	073160646
47	12	308	96,00	1	073160647
48	13	315	96,00	1	073160648

CE



S1P SRC ESD



7317NA

Sapato de camurça, perfurado, com reforço de microfibras na zona do calcanhar

- Biqueira em compósito
- Palmilha anti-perfuração em fibra compósita

EU	UK	mm	€	U	U
35	2.5	228	82,50	1	073170135
36	3.5	235	82,50	1	073170136
37	4.5	242	82,50	1	073170137
38	5	248	82,50	1	073170138
39	6	255	82,50	1	073170139
40	6.5	262	82,50	1	073170140
41	7	268	82,50	1	073170141
42	8	275	82,50	1	073170142
43	9	282	82,50	1	073170143
44	10	288	82,50	1	073170144
45	10.5	295	82,50	1	073170145
46	11	302	82,50	1	073170146
47	12	308	82,50	1	073170147
48	13	315	82,50	1	073170148

CE



S1P SRC



7318AN

Sapato de trabalho, de camurça e microfibra, à prova de água com inserts em carbono

- Biqueira em compósito
- Palmilha anti-perfuração em fibra compósita

EU	UK	mm	€	U	U
35	2.5	228	133,00	1	073180535
36	3.5	235	133,00	1	073180536
37	4.5	242	133,00	1	073180537
38	5	248	133,00	1	073180538
39	6	255	133,00	1	073180539
40	6.5	262	133,00	1	073180540
41	7	268	133,00	1	073180541
42	8	275	133,00	1	073180542
43	9	282	133,00	1	073180543
44	10	288	133,00	1	073180544
45	10.5	295	133,00	1	073180545
46	11	302	133,00	1	073180546
47	12	308	133,00	1	073180547
48	13	315	133,00	1	073180548

CE



S3 SRC



7320NA

Sapato em pele nubuck, impermeável, biqueira com reforço anti-abrasão

- Biqueira em compósito
- Palmilha anti-perfuração em fibra compósita

EU	UK	mm	€	U	U
35	2.5	228	87,00	1	073200435
36	3.5	235	87,00	1	073200436
37	4.5	242	87,00	1	073200437
38	5	248	87,00	1	073200438
39	6	255	87,00	1	073200439
40	6.5	262	87,00	1	073200440
41	7	268	87,00	1	073200441
42	8	275	87,00	1	073200442
43	9	282	87,00	1	073200443
44	10	288	87,00	1	073200444
45	10.5	295	87,00	1	073200445
46	11	302	87,00	1	073200446
47	12	308	87,00	1	073200447
48	13	315	87,00	1	073200448

CE



S3 SRC



7321NA

Sapato em pele nubuck, impermeável, com sistema de abertura rápida e biqueira com reforço anti-abrasão

- Biqueira em compósito
- Palmilha anti-perfuração em fibra compósita

EU	UK	mm	€	W	W
35	2,5	228	89,50	1	073210435
36	3,5	235	89,50	1	073210436
37	4,5	242	89,50	1	073210437
38	5	248	89,50	1	073210438
39	6	255	89,50	1	073210439
40	6,5	262	89,50	1	073210440
41	7	268	89,50	1	073210441
42	8	275	89,50	1	073210442
43	9	282	89,50	1	073210443
44	10	288	89,50	1	073210444
45	10,5	295	89,50	1	073210445
46	11	302	89,50	1	073210446
47	12	308	89,50	1	073210447
48	13	315	89,50	1	073210448

CE



S3 RS SRC



EN ISO 20345 2011



7322SA

sapato em tecido, elevada resistência à abrasão, com suporte à estabilidade do calcanhar

- Biqueira em compósito
- Palmilha anti-perfuração em fibra compósita

EU	UK	mm	€	W	W
35	2,5	228	94,00	1	073220435
36	3,5	235	94,00	1	073220436
37	4,5	242	94,00	1	073220437
38	5	248	94,00	1	073220438
39	6	255	94,00	1	073220439
40	6,5	262	94,00	1	073220440
41	7	268	94,00	1	073220441
42	8	275	94,00	1	073220442
43	9	282	94,00	1	073220443
44	10	288	94,00	1	073220444
45	10,5	295	94,00	1	073220445
46	11	302	94,00	1	073220446
47	12	308	94,00	1	073220447
48	13	315	94,00	1	073220448

CE



S3 SRC



EN ISO 20345 2011



7323SA

botim em tecido, elevada resistência à abrasão, com sistema de abertura rápida e suporte à estabilidade do calcanhar

- Biqueira em compósito
- Palmilha anti-perfuração em fibra compósita

EU	UK	mm	€	W	W
35	2,5	228	96,50	1	073230435
36	3,5	235	96,50	1	073230436
37	4,5	242	96,50	1	073230437
38	5	248	96,50	1	073230438
39	6	255	96,50	1	073230439
40	6,5	262	96,50	1	073230440
41	7	268	96,50	1	073230441
42	8	275	96,50	1	073230442
43	9	282	96,50	1	073230443
44	10	288	96,50	1	073230444
45	10,5	295	96,50	1	073230445
46	11	302	96,50	1	073230446
47	12	308	96,50	1	073230447
48	13	315	96,50	1	073230448

CE



S3 RS SRC



EN ISO 20345 2011



Beta

O-GRAVITY



7352A

sapato em tecido respirável, com aplicações em TPU
Apoio de estabilidade do calcanhar, rebordo elástico, e sola em borracha nitrílica resistente EVA

- Biqueira em material compósito
- Palmilha anti-perfuração em fibra compósita
- EXTREMAMENTE LEVE: peso aproximado, tamanho 42: 450 g

**EN ISO
20345
2011**

EU	UK	mm	€	U	U
38	5	254	144,00	1	073520038
39	6	261	144,00	1	073520039
40	6,5	268	144,00	1	073520040
41	7	274	144,00	1	073520041
42	8	281	144,00	1	073520042
43	9	288	144,00	1	073520043
44	10	294	144,00	1	073520044
45	10,5	301	144,00	1	073520045
46	11	308	144,00	1	073520046
47	12	314	144,00	1	073520047
48	13	321	144,00	1	073520048



CE

S1P HRO SRC

7352B

sapato em tecido respirável, com aplicações em TPU
Apoio de estabilidade do calcanhar, rebordo elástico, e sola em borracha nitrílica resistente EVA

- Biqueira em material compósito
- Palmilha anti-perfuração em fibra compósita
- EXTREMAMENTE LEVE: peso aproximado, tamanho 42: 450 g

**EN ISO
20345
2011**

EU	UK	mm	€	U	U
38	5	254	144,00	1	073520138
39	6	261	144,00	1	073520139
40	6,5	268	144,00	1	073520140
41	7	274	144,00	1	073520141
42	8	281	144,00	1	073520142
43	9	288	144,00	1	073520143
44	10	294	144,00	1	073520144
45	10,5	301	144,00	1	073520145
46	11	308	144,00	1	073520146
47	12	314	144,00	1	073520147
48	13	321	144,00	1	073520148



CE

S1P HRO SRC

7352G

sapato em tecido de malha de rede altamente respirável, com inserts TPU
suporte à estabilidade do calcanhar, com atacadores, pé largo. sola EVA com rasto em borracha nitrílica

- Biqueira em material compósito
- Palmilha anti-perfuração em fibra compósita
- EXTREMAMENTE LEVE: peso aproximado tamanho 42: 450 g

**EN ISO
20345
2011**

EU	UK	mm	€	U	U
38	5	254	149,00	1	073520338
39	6	261	149,00	1	073520339
40	6,5	268	149,00	1	073520340
41	7	274	149,00	1	073520341
42	8	281	149,00	1	073520342
43	9	288	149,00	1	073520343
44	10	294	149,00	1	073520344
45	10,5	301	149,00	1	073520345
46	11	308	149,00	1	073520346
47	12	314	149,00	1	073520347
48	13	321	149,00	1	073520348



CE

S1P HRO SRC ESD

7352LG

sapato de senhora em tecido de malha de rede, altamente respirável, com aplicações em TPU
gáspea com malha refletora de alta visibilidade
suporte à estabilidade do calcanhar, rebordo elástico no tornozelo
e sola em EVA com rasto em borracha nitrilica

- Biqueira em fibra de vidro
- Palmilha anti-perfuração em fibra compósita
- EXTREMAMENTE LEVE: peso aproximado tamanho38: 390 g

**EN ISO
20345
2011**

EU	UK	mm	€	W	W
34	2	228	149,00	1	073520234
35	2,5	234	149,00	1	073520235
36	3,5	241	149,00	1	073520236
37	4,5	248	149,00	1	073520237
38	5	254	149,00	1	073520238
39	6	261	149,00	1	073520239
40	6,5	268	149,00	1	073520240
41	7	274	149,00	1	073520241
42	8	281	149,00	1	073520242

CE



S1P HRO SRC

METAL
FREE



7353Y

sapato em tecido respirável, com aplicações em TPU
Malha refletora de alta visibilidade
Apoio de estabilidade do calcanhar, rebordo elástico, e sola em borracha nitrilica resistente EVA

- Biqueira em fibra de carbono
- Palmilha anti-perfuração em fibra compósita
- EXTREMAMENTE LEVE: peso aproximado, tamanho 42: 420 g

**EN ISO
20345
2011**

EU	UK	mm	€	W	W
38	5	254	185,00	1	073530038
39	6	261	185,00	1	073530039
40	6,5	268	185,00	1	073530040
41	7	274	185,00	1	073530041
42	8	281	185,00	1	073530042
43	9	288	185,00	1	073530043
44	10	294	185,00	1	073530044
45	10,5	301	185,00	1	073530045
46	11	308	185,00	1	073530046
47	12	314	185,00	1	073530047
48	13	321	185,00	1	073530048

CE



S1P HRO SRC



7354N

sapato em tecido, impermeável, com aplicações em TPU
Apoio de estabilidade do calcanhar, rebordo elástico, e sola em borracha nitrilica resistente EVA

- Biqueira em material compósito
- Palmilha anti-perfuração em fibra compósita
- EXTREMAMENTE LEVE: peso aproximado, tamanho 42: 460 g

**EN ISO
20345
2011**

EU	UK	mm	€	W	W
38	5	254	149,00	1	073540038
39	6	261	149,00	1	073540039
40	6,5	268	149,00	1	073540040
41	7	274	149,00	1	073540041
42	8	281	149,00	1	073540042
43	9	288	149,00	1	073540043
44	10	294	149,00	1	073540044
45	10,5	301	149,00	1	073540045
46	11	308	149,00	1	073540046
47	12	314	149,00	1	073540047
48	13	321	149,00	1	073540048

CE



S3 HRO SRC



METAL
FREE



7355V

botim em tecido, impermeável, com aplicações em TPU
Apoio de estabilidade do calcanhar, rebordo elástico, e sola em borracha nitrilica resistente EVA

- Biqueira em material compósito
- Palmilha anti-perfuração em fibra compósita
- EXTREMAMENTE LEVE: peso aproximado, tamanho 42: 465 g

**EN ISO
20345
2011**

EU	UK	mm	€	W	W
38	5	254	159,00	1	073550038
39	6	261	159,00	1	073550039
40	6,5	268	159,00	1	073550040
41	7	274	159,00	1	073550041
42	8	281	159,00	1	073550042
43	9	288	159,00	1	073550043
44	10	294	159,00	1	073550044
45	10,5	301	159,00	1	073550045
46	11	308	159,00	1	073550046
47	12	314	159,00	1	073550047
48	13	321	159,00	1	073550048

CE



S3 HRO SRC



METAL
FREE



7356G

sapato em microfibras, impermeável, com aplicações em TPU. Apoio de estabilidade no calcanhar, rebordo elástico e sola em EVA com rastro resistente em borracha nitrílica.

- Biqueira em material compósito
- Palmilha anti-perfuração em fibra compósita
- EXTREMAMENTE LEVE: peso aproximado para tamanho 42: 460 g

**EN ISO
20345
2011**

EU	UK	mm	€		
38	5	254	154,00	1	073560038
39	6	261	154,00	1	073560039
40	6,5	268	154,00	1	073560040
41	7	274	154,00	1	073560041
42	8	281	154,00	1	073560042
43	9	288	154,00	1	073560043
44	10	294	154,00	1	073560044
45	10,5	301	154,00	1	073560045
46	11	308	154,00	1	073560046
47	12	314	154,00	1	073560047
48	13	321	154,00	1	073560048

CE



METAL
FREE



S3 HRO SRC

7356V

sapato em microfibras, impermeável, com aplicações em TPU suporte à estabilidade do calcanhar, rebordo elástico no tornozelo e sola em EVA com rasto em borracha nitrílica

- Biqueira em compósito
- Palmilha anti-perfuração em fibra compósita
- EXTREMAMENTE LEVE: peso aproximado tamanho 42: 460 g

**EN ISO
20345
2011**

EU	UK	mm	€		
38	5	254	154,00	1	073560138
39	6	261	154,00	1	073560139
40	6,5	268	154,00	1	073560140
41	7	274	154,00	1	073560141
42	8	281	154,00	1	073560142
43	9	288	154,00	1	073560143
44	10	294	154,00	1	073560144
45	10,5	301	154,00	1	073560145
46	11	308	154,00	1	073560146
47	12	314	154,00	1	073560147
48	13	321	154,00	1	073560148

CE



METAL
FREE



S3 HRO SRC

7356LN

sapato de senhora em microfibras, impermeável, com aplicações em TPU suporte à estabilidade do calcanhar, rebordo elástico no tornozelo e sola em EVA com rasto em borracha nitrílica

- Biqueira em fibra de vidro
- Palmilha anti-perfuração em fibra compósita
- EXTREMAMENTE LEVE: peso aproximado tamanho 38: 400 g

**EN ISO
20345
2011**

EU	UK	mm	€		
34	2	228	153,00	1	073560234
35	2,5	234	153,00	1	073560235
36	3,5	241	153,00	1	073560236
37	4,5	248	153,00	1	073560237
38	5	254	153,00	1	073560238
39	6	261	153,00	1	073560239
40	6,5	268	153,00	1	073560240
41	7	274	153,00	1	073560241
42	8	281	153,00	1	073560242

CE



METAL
FREE



S3 HRO SRC

7357G

botim em microfibras, impermeável, aplicações em TPU Apoio de estabilidade no calcanhar, rebordo elástico e sola em EVA com rastro em borracha nitrílica

- Biqueira em material compósito
- Palmilha anti-perfuração em fibra compósita
- EXTREMAMENTE LEVE: peso aproximado para tamanho 42: 480 g

**EN ISO
20345
2011**

EU	UK	mm	€		
38	5	254	170,00	1	073570038
39	6	261	170,00	1	073570039
40	6,5	268	170,00	1	073570040
41	7	274	170,00	1	073570041
42	8	281	170,00	1	073570042
43	9	288	170,00	1	073570043
44	10	294	170,00	1	073570044
45	10,5	301	170,00	1	073570045
46	11	308	170,00	1	073570046
47	12	314	170,00	1	073570047
48	13	321	170,00	1	073570048

CE



METAL
FREE



S3 HRO SRC

7357V

botim em microfibra, impermeável, com aplicações em TPU suporte à estabilidade do calcanhar, rebordo elástico no tornozelo e sola em EVA com rasto em borracha nitrilica

- Biqueira em compósito
- Palmilha anti-perfuração em fibra compósita
- EXTREMAMENTE LEVE: peso aproximado tamanho 42: 480 g

EN ISO 20345 2011

EU	UK	mm	€	W	W
38	5	254	170,00	1	073570138
39	6	261	170,00	1	073570139
40	6,5	268	170,00	1	073570140
41	7	274	170,00	1	073570141
42	8	281	170,00	1	073570142
43	9	288	170,00	1	073570143
44	10	294	170,00	1	073570144
45	10,5	301	170,00	1	073570145
46	11	308	170,00	1	073570146
47	12	314	170,00	1	073570147
48	13	321	170,00	1	073570148

CE



S3 HRO SRC

7362B

sapatos de trabalho, em tecido de malha muito respirável, com aplicações em TPU.

Apoio de estabilidade para o calcanhar, rebordo elástico e sola em borracha nitrilica resistente EVA

- Sem biqueira
- Sem sola intermédia anti-perfuração
- EXTRAORDINARIAMENTE LEVES: peso aprox. tamanho 42: 330 g

EN ISO 20347 2012

EU	UK	mm	€	W	W
39	6	261	131,00	1	073620039
40	6,5	268	131,00	1	073620040
41	7	274	131,00	1	073620041
42	8	281	131,00	1	073620042
43	9	288	131,00	1	073620043
44	10	294	131,00	1	073620044
45	10,5	301	131,00	1	073620045
46	11	308	131,00	1	073620046
47	12	314	131,00	1	073620047
48	13	321	131,00	1	073620048

CE



O1 FO HRO SRC

7363N

sapato de trabalho em tecido de malha, impermeável, com aplicações em TPU.

Apoio de estabilidade para o calcanhar, rebordo elástico e sola em borracha nitrilica resistente EVA

- Sem biqueira
- Sem sola intermédia anti-perfuração
- EXTRAORDINARIAMENTE LEVES: peso aprox. tamanho 42: 330 g

EN ISO 20347 2012

EU	UK	mm	€	W	W
39	6	261	136,00	1	073630039
40	6,5	268	136,00	1	073630040
41	7	274	136,00	1	073630041
42	8	281	136,00	1	073630042
43	9	288	136,00	1	073630043
44	10	294	136,00	1	073630044
45	10,5	301	136,00	1	073630045
46	11	308	136,00	1	073630046
47	12	314	136,00	1	073630047
48	13	321	136,00	1	073630048

CE



O2 FO HRO SRC

7371V

sapato em tecido, ultrarespirável.

Com apoio de estabilidade no calcanhar, atacadores tradicionais, modelo largo.

Sola EVA com rasto durável em borracha de nitrilo.

- Biqueira em material compósito
- Palmilha anti-perfuração em fibra compósita
- EXTREMAMENTE LEVE: peso aproximado, tamanho 42: 450 g

EN ISO 20345 2022

EU	UK	mm	€	W	W
38	5	254	149,00	1	073710038
39	6	261	149,00	1	073710039
40	6,5	268	149,00	1	073710040
41	7	274	149,00	1	073710041
42	8	281	149,00	1	073710042
43	9	288	149,00	1	073710043
44	10	294	149,00	1	073710044
45	10,5	301	149,00	1	073710045
46	11	308	149,00	1	073710046
47	12	314	149,00	1	073710047
48	13	321	149,00	1	073710048

CE



S1PS HRO FO SR ESD

7372B

sapatos em tecido, ultra-resistentes e ultra-respiráveis. Com apoio de estabilidade no calcanhar, atacadores tradicionais, modelo largo. Sola EVA com rasto durável em borracha de nitrilo.

- Biqueira em compósito
- Palmilha anti-perfuração em fibra compósita
- INCRIVELMENTE LEVES: peso aprox. tamanho 42: 450 g

**EN ISO
20345
2011**

EU	UK	mm	€		
38	5	254	153,00	1	073720038
39	6	261	153,00	1	073720039
40	6.5	268	153,00	1	073720040
41	7	274	153,00	1	073720041
42	8	281	153,00	1	073720042
43	9	288	153,00	1	073720043
44	10	294	153,00	1	073720044
45	10.5	301	153,00	1	073720045
46	11	308	153,00	1	073720046
47	12	314	153,00	1	073720047
48	13	321	153,00	1	073720048

CE



S1P HRO SRC



7376A

sapatos com aberturas, em microfibra e rede, perfurados e altamente respiráveis. Com apoio de estabilidade no calcanhar, atacadores tradicionais com elasticidade, modelo largo. Sola EVA com rasto durável em borracha de nitrilo.

- Biqueira em compósito
- Palmilha anti-perfuração em fibra compósita
- INCRIVELMENTE LEVES: peso aprox. tamanho 42: 490 g

**EN ISO
20345
2011**

EU	UK	mm	€		
38	5	254	155,00	1	073760038
39	6	261	155,00	1	073760039
40	6.5	268	155,00	1	073760040
41	7	274	155,00	1	073760041
42	8	281	155,00	1	073760042
43	9	288	155,00	1	073760043
44	10	294	155,00	1	073760044
45	10.5	301	155,00	1	073760045
46	11	308	155,00	1	073760046
47	12	314	155,00	1	073760047
48	13	321	155,00	1	073760048

CE



S1P HRO SRC



7381N

sapatos impermeáveis, em tecido altamente resistente à abrasão, com inserções em TPU. Suporte de estabilidade no calcanhar, atacadores tradicionais, modelo largo. Sola de EVA com rasto em borracha nitrílica durável.

- Biqueira composta
- Palmilha anti-perfuração em fibra composta
- Membrana impermeabilizante Beta TECH, com sistema bootie
- LEVE: peso aproximado para tamanho 42: 500 g

**EN ISO
20345
2011**

EU	UK	mm	€		
38	5	254	177,00	1	073810038
39	6	261	177,00	1	073810039
40	6.5	268	177,00	1	073810040
41	7	274	177,00	1	073810041
42	8	281	177,00	1	073810042
43	9	288	177,00	1	073810043
44	10	294	177,00	1	073810044
45	10.5	301	177,00	1	073810045
46	11	308	177,00	1	073810046
47	12	314	177,00	1	073810047
48	13	321	177,00	1	073810048

CE



S3 SRC HRO WR



7382N

sapatos impermeáveis, em tecido altamente resistente à abrasão, com inserções em TPU. Suporte de estabilidade no calcanhar, atacadores tradicionais, modelo largo. Sola de EVA com rasto em borracha nitrílica durável.

- Biqueira composta
- Palmilha anti-perfuração em fibra composta
- Membrana impermeabilizante Beta TECH, com sistema bootie
- LEVE: peso aproximado para tamanho 42: 550 g

**EN ISO
20345
2011**

EU	UK	mm	€		
38	5	254	198,00	1	073820038
39	6	261	198,00	1	073820039
40	6.5	268	198,00	1	073820040
41	7	274	198,00	1	073820041
42	8	281	198,00	1	073820042
43	9	288	198,00	1	073820043
44	10	294	198,00	1	073820044
45	10.5	301	198,00	1	073820045
46	11	308	198,00	1	073820046
47	12	314	198,00	1	073820047
48	13	321	198,00	1	073820048

CE



S3 SRC HRO WR



HEAVY DUTY



7293HM

Bota em pele natural, lubrificada, impermeável, com sola de borracha VIBRAM®, Anti-abrasão inserido na zona do calcanhar e na biqueira. Com proteção e reforço de poliuretano.

- Biqueira em fibra de vidro
- Palmilha anti-perfuração em fibra reforçada

EN ISO 20345 2011



EU	UK	mm	€	W	W
39	6	263	198,00	1	072930639
40	6,5	270	198,00	1	072930640
41	7	276	198,00	1	072930641
42	8	283	198,00	1	072930642
43	9	289	198,00	1	072930643
44	10	296	198,00	1	072930644
45	10,5	302	198,00	1	072930645
46	11	309	198,00	1	072930646
47	12	315	198,00	1	072930647
48	13	322	198,00	1	072930648



CE

S3 HRO HI SRC

7294HM

Bota em pele natural, impermeável, com sola de borracha VIBRAM®, Anti-abrasão inserido na zona do calcanhar e na biqueira. Com proteção e reforço de poliuretano.

- Biqueira em fibra de vidro
- Palmilha anti-perfuração em fibra compósita

EN ISO 20345 2011



EU	UK	mm	€	W	W
39	6	263	210,00	1	072940639
40	6,5	270	210,00	1	072940640
41	7	276	210,00	1	072940641
42	8	283	210,00	1	072940642
43	9	289	210,00	1	072940643
44	10	296	210,00	1	072940644
45	10,5	302	210,00	1	072940645
46	11	309	210,00	1	072940646
47	12	315	210,00	1	072940647
48	13	322	210,00	1	072940648



CE

S3 HRO HI SRC

7294HMC

Bota em pele natural, impermeável, com sola de borracha VIBRAM®, Anti-abrasão inserido na zona do calcanhar e na biqueira. Com membrana de Tepor, impermeável, à prova de vento e respirável.

- Biqueira em fibra de vidro
- Palmilha anti-perfuração em fibra reforçada

EN ISO 20345 2011



EU	UK	mm	€	W	W
39	6	263	234,00	1	072940739
40	6,5	270	234,00	1	072940740
41	7	276	234,00	1	072940741
42	8	283	234,00	1	072940742
43	9	289	234,00	1	072940743
44	10	296	234,00	1	072940744
45	10,5	302	234,00	1	072940745
46	11	309	234,00	1	072940746
47	12	315	234,00	1	072940747
48	13	322	234,00	1	072940748



CE

S3 HRO HI CI WR SRC

ACCESSORIES

7398 0/G

palmilhas anatómicas em borracha EVA, com amortecimento no calcanhar (recomendadas para a linha de calçado 0-Gravity)



EU	UK	€	📄	📱
38	5	8,10	1	073981238
39	6	8,10	1	073981239
40	6,5	8,10	1	073981240
41	7	8,10	1	073981241
42	8	8,10	1	073981242
43	9	8,10	1	073981243
44	10	8,10	1	073981244
45	10,5	8,10	1	073981245
46	11	8,10	1	073981246
47	12	8,10	1	073981247
48	13	8,10	1	073981248

7398ESD

formato anatómico, palmilha respirável, camada superior antibacteriana para prevenção de maus odores. Substituição para calçado certificado ESD (Descarga Eletroestática).



EU	UK	€	📄	📱
35	2,5	9,30	1	073981435
36	3,5	9,30	1	073981436
37	4,5	9,30	1	073981437
38	5	9,30	1	073981438
39	6	9,30	1	073981439
40	6,5	9,30	1	073981440
41	7	9,30	1	073981441
42	8	9,30	1	073981442
43	9	9,30	1	073981443
44	10	9,30	1	073981444
45	10,5	9,30	1	073981445
46	11	9,30	1	073981446
47	12	9,30	1	073981447
48	13	9,30	1	073981448

7398T

palmilhas anatómicas com isolamento WINTHERM. 70% poliéster aluminizado, 30% polietileno, fibras sintéticas. Material antiestático, respirável, absorção rápida, anti-odores, antibacteriano, antifúngica.



WINDTHERM

EU	UK	€	📄	📱
35	2,5	16,10	1	073981335
36	3,5	16,10	1	073981336
37	4,5	16,10	1	073981337
38	5	16,10	1	073981338
39	6	16,10	1	073981339
40	6,5	16,10	1	073981340
41	7	16,10	1	073981341
42	8	16,10	1	073981342
43	9	16,10	1	073981343
44	10	16,10	1	073981344
45	10,5	16,10	1	073981345
46	11	16,10	1	073981346
47	12	16,10	1	073981347
48	13	16,10	1	073981348

7398U

palmilhas anatómicas em GEL TPR com efeito de amortecimento, suporte para arco plantar e calcanhar



EU	UK	€	📄	📱
36 - 40	3,5 - 6,5	14,90	1	073980058
41 - 46	7 - 11	14,90	1	073980063



7398UP

palmilhas anatómicas em GEL TPE com fragrância cítrica e suporte para arco plantar



EU	UK	€	📄	📱
36 - 40	3,5 - 6	13,60	1	073980076
41 - 46	7 - 11	13,60	1	073980081

7398GEL

palmilhas com formas anatómicas cobertas com aplicações gel



EU	UK	€	📄	📱
35	2,5	4,90	1	073980835
36	3,5	4,90	1	073980836
37	4,5	4,90	1	073980837
38	5	4,90	1	073980838
39	6	4,90	1	073980839
40	6,5	4,90	1	073980840
41	7	4,90	1	073980841
42	8	4,90	1	073980842
43	9	4,90	1	073980843
44	10	4,90	1	073980844
45	10,5	4,90	1	073980845
46	11	4,90	1	073980846
47	12	4,90	1	073980847
48	13	4,90	1	073980848

7398EF

palmilhas anatómicas em espuma de poliuretano, com elevação do calcanhar



EU	UK	€	👤	📦
35	2,5	9,40	1	073981135
36	3,5	9,40	1	073981136
37	4,5	9,40	1	073981137
38	5	9,40	1	073981138
39	6	9,40	1	073981139
40	6,5	9,40	1	073981140
41	7	9,40	1	073981141
42	8	9,40	1	073981142
43	9	9,40	1	073981143
44	10	9,40	1	073981144
45	10,5	9,40	1	073981145
46	11	9,40	1	073981146
47	12	9,40	1	073981147
48	13	9,40	1	073981148

7399 A/N...

embalagem com 10 pares de atacadores



cm	€	👤	📦
100	17,70	1	073990010
120	20,90	1	073990012
140	25,50	1	073990017

Os preços indicados são para 10 unidades

7421

Meias de compressão, até ao joelho, reforçadas com nylon e algodão nos dedos e calcanhar. Sola de fibra de bambu resistente, antimicótico e respirável.



👤	EU	€	👤	📦
M	39-42	18,80	1	074210002
L	43-46	18,80	1	074210004

7422P

meias de cano alto em algodão reciclado, com reforço na biqueira e calcanhar
2 pares
variantes de cor:
preto com aplicações em cinza, laranja e castanho
cinza com aplicações em preto, laranja e castanho



👤	EU	€	👤	📦
M	39-42	16,40	1	074220102
L	43-46	16,40	1	074220104

7425

Meias respiráveis e reforçadas com nylon/algodão nos dedos e calcanhar. Sola de nylon com fibra de bambu resistente, antimicótica e respirável.



👤	EU	€	👤	📦
M	39-42	12,40	1	074250002
L	43-46	12,40	1	074250004

7426P

meias de cano médio em algodão reciclado, com sola em algodão felpudo e reforço na biqueira e calcanhar
2 pares
variantes de cor:
cinza com aplicações em preto e azul elétrico
preto com aplicações em cinza e azul elétrico



👤	EU	€	👤	📦
M	39-42	15,30	1	074260102
L	43-46	15,30	1	074260104

7427

Meias Sneaker com proteções e respiração na zona da tibia e peito do pé. Reforçadas com nylon e algodão na zona dos dedos e calcanhar. Sola de fibra antimicótica resistente e respirável.



👤	EU	€	👤	📦
M	39-42	10,50	1	074270002
L	43-46	10,50	1	074270004

7430T

meias de cano baixo em algodão reciclado, com reforço na biqueira e calcanhar
3 pares
variantes de cor:
cinza melange com aplicações em preto e bordeaux
preto com aplicações em cinza
cinza melange com aplicações em preto



👤	EU	€	👤	📦
M	39-42	19,70	1	074300202
L	43-46	19,70	1	074300204

7431P

Dois pares de meias até ao tornozelo, com textura respirável e reforços em nylon/algodão nos dedos e calcanhar.

Solas em nylon com fibra de bambu, resistente, antifúngico e respirável.
Um par em cor em preto/laranja, outro par em cor preto/cinza.



👤	EU	€	👤	📦
M	39-42	9,30	1	074310102
L	43-46	9,30	1	074310104

VESTUÁRIO DE TRABALHO



Ao longo dos anos a linha de vestuário de trabalho ganhou popularidade e a confiança dos profissionais mais exigentes. O sucesso dos produtos traduziu-se na expansão e constante desenvolvimento desta linha.

O vestuário de trabalho fabricado pela Beta Utensili S.p.a. cumpre as seguintes normas:

EN ISO 13688:2013

Os equipamentos de protecção pessoal protegem o utilizador de perigos físicos limitados, como pequenas escoriações, raios solares, vento, frio, poeiras e sujidade resultantes de materiais não tóxicos. Este nível de protecção está relacionado com a primeira categoria do Projecto-lei n.º. 475 de 04/12/1992 do Parlamento Italiano.

INSTRUÇÕES DE UTILIZAÇÃO E ARMAZENAMENTO

Para assegurar a protecção das diferentes partes do corpo do utilizador, os artigos devem ser correctamente utilizados. Devem igualmente ser armazenados em local fresco e seco, na embalagem original, afastados de fontes de calor e ao abrigo da luz solar, poeiras e condições atmosféricas adversas.

ENCOLHIMENTO

Todas as fibras naturais encolhem após a lavagem. O grau de encolhimento pode variar entre 1% e 5%, dependendo de vários parâmetros, que incluem o tipo de fibras e a temperatura a água.

CORRESPONDÊNCIA DE TAMANHOS

VESTUÁRIO MASCULINO	I F D E UK USA						VESTUÁRIO FEMININO	I F D E UK USA					
	XS	S	M	L	XL	XXL		XS	S	M	L	XL	XXL
	46	48	50	52	54	58	38	40	42	44	46	48	50
	38	40	42	44	46	50	34	36	38	40	42	44	46
	42	44	46	48	50	54	36	38	40	42	44	46	48
	44	46	48	50	52	56	38	40	42	44	46	48	50
	46	48	50	52	54	58	40	42	44	46	48	50	52
	48	50	52	54	56	60	42	44	46	48	50	52	54
	50	52	54	56	58	62	44	46	48	50	52	54	56

TAMANHOS ANATÓMICOS EN ISO 13688:2013









































VESTUÁRIO MASCULINO									
	XS	S	M	L	XL	2XL	3XL	4XL	5XL
A	88-92	92-96	96-104	104-108	108-116	116-124	124-132	132-140	140-148
B	79-83	83-87	87-91	91-95	95-100	100-107	107-112	112-120	120-128
H	158-164	164-170	170-176	176-182	182-188	188-194	194-200	200-206	206-212

VESTUÁRIO FEMININO							
	XS	S	M	L	XL	2XL	3XL
B	72-77	77-82	82-87	87-93	93-99	99-105	105-111
H	162-165	164-167	168-171	170-173	172-175	174-177	176-179

GUIA DE VESTUÁRIO - CATÁLOGO 2024

Categoria	N.º Artigo	Linha	Pág.	Cor	Conjugações recomendadas (tecido e cor idênticos às calças)									
					Calções bermuda	Pág.	Jardineiras	Pág.	Macacões	Pág.	Coletes	Pág.	Casacos	Pág.
CALÇAS DE TRABALHO, LEVES	7610G	Trekking	653	■	7611G	657								
	7610N		653	■										
	7660B	Top Line	653	■	7661B	657								
	7660G		653	■	7661G	657								
	7830SN	Stretch	654	■	7831SN	657								
	7860G	Beta Easy	655	■	7861G	658	7863G	658	7865G	659	7867G	661	7869G	660
	7860B		655	■	7861B	658			7865B	659	7867B	661		
7930MG	Cotton	656	■	7931MG	658			7935MG	659	7937MG	662			
CALÇAS DE TRABALHO, 4 ESTAÇÕES	7600G	Trekking	652	■										
	7600N		652	■										
	7650	Top Line	653	■								7653G	660	
	7650B		653	■										
	7818BL		654	■										
	7818CM		654	■	7815CM	657								
	7818G		654	■										
	7819G		654	■										
	7830ST	Stretch	655	■	7831ST	657								
	7840BL	Beta Easy	655	■								7849BL	660	
	7850G		655	■										
	7880SC	Stretch	655	■										
	7900B		656	■								7909B	660	
	7900G	Beta Easy	656	■	7901G	658	7903G	659	7905G	659	7907G	662	7909G	660
	7900P		656	■			7903P	659				7909P	660	
7900V	656		■								7909V	660		
7940	Multiprotection	656	■								7949	661		
7818LN	Lady	654	■											

GUIA DE VESTUÁRIO - CATÁLOGO 2024

Categoria	N.º Artigo	Linha	Pág.	Cor	Conjugações recomendadas (tecido e cor idênticos às calças)								
					Calções bermuda	Pág.	Jardineiras	Pág.	Macacões	Pág.	Coletes	Pág.	Casacos
JEANS DE TRABALHO	7530		652										
	7528		652		7529	657							
	7527		652										
POLOS	7547AZ		664		CONJUGUE TODOS OS OUTROS ARTIGOS DE ACORDO COM COMBINAÇÕES DE CORES								
	7547BL		665										
	7547G		665										
	7547N		665										
	7547R		665										
	7557BL		666										
T-SHIRTS	7548M		665		CONJUGUE TODOS OS OUTROS ARTIGOS DE ACORDO COM COMBINAÇÕES DE CORES								
	7548C		665										
	7549AZ		665										
	7549BL		665										
	7549G		665										
	7549N		666										
	7549NE		666										
	7549R		666										
	7550G	Top Line	666										
7550N	Top Line	666											
CAMISAS	7545F		664										
SWEATSHIRTS	7637G		663		CONJUGUE TODOS OS OUTROS ARTIGOS DE ACORDO COM COMBINAÇÕES DE CORES								
	7642G		663										
	7664G	Top Line	664										
	7664N		664										
	7665G		664										
	7665N		664										
CAMISOLAS POLARES	7636N		663		CONJUGUE TODOS OS OUTROS ARTIGOS DE ACORDO COM COMBINAÇÕES DE CORES								
	7654B	Top Line	663										
	7654N		664										
	7657B		664										
	7657N		667										
COLETES	7575N		661		CONJUGUE TODOS OS OUTROS ARTIGOS DE ACORDO COM COMBINAÇÕES DE CORES								
	7579QN		661										
	7673NG	Top Line	661										
CASACOS CORTA-VENTO	7658CM	Top Line	662		CONJUGUE TODOS OS OUTROS ARTIGOS DE ACORDO COM COMBINAÇÕES DE CORES								
	7659N		662										
	7669N		662										
BLUSÕES	7670G	Top Line	662		CONJUGUE TODOS OS OUTROS ARTIGOS DE ACORDO COM COMBINAÇÕES DE CORES								
	7674NG		663										
	7780QN		663										
	7750N		663										

GUIA DE VESTUÁRIO - CATÁLOGO 2024

Categoria	N.º Artigo	Linha	Pág.	Cor	Conjugações recomendadas (tecido e cor idênticos às calças)								
					Calções bermuda	Pág.	Jardineiras	Pág.	Macacões	Pág.	Coletes	Pág.	Casacos
VESTUÁRIO IMPERMEÁVEL	7970	Trousers	666									7979	667
	7971L	Trousers	667									7978L	667
	7981N	Rainproof hat	668										
ACESSÓRIOS	7980NC	Cap	668		CONJUGUE TODOS OS OUTROS ARTIGOS DE ACORDO COM COMBINAÇÕES DE CORES								
	7980RN	Cap	668										
	7980L	Cap with light	668										
	7982N	Cap	668										
	7984EG	Belt	668										
	7984G	Belt	668										
	7985N	Snood	668										
	7996N	Technical underwear set	667										

PANTS



7527

jeans de trabalho,
70% algodão, 27% poliéster e 3% elastano
Regular fit

CE

Jeans



XXXXXX	I	€	U	U
XS	46	57,00	1	075270046
S	48	57,00	1	075270048
M	50	57,00	1	075270050
L	52	57,00	1	075270052
XL	54	57,00	1	075270054
XXL	56	57,00	1	075270056
XXXL	58	57,00	1	075270058

7528

Jeans de trabalho elásticos, 98% cotton, 2% elastano, modelo slim

CE

Jeans



XXXXXX	I	€	U	U
XS	46	63,00	1	075280046
S	48	63,00	1	075280048
M	50	63,00	1	075280050
L	52	63,00	1	075280052
XL	54	63,00	1	075280054
XXL	56	63,00	1	075280056
XXXL	58	63,00	1	075280058

7530

calças de trabalho elásticas, 98% algodão e 2% tecido elástico, com reforços em poliéster. Modelo slim.

CE

Jeans



XXXXXX	I	€	U	U
XS	46	73,50	1	075300046
S	48	73,50	1	075300048
M	50	73,50	1	075300050
L	52	73,50	1	075300052
XL	54	73,50	1	075300054
XXL	56	73,50	1	075300056
XXXL	58	73,50	1	075300058

7600G

calças "work trekking", PESADAS, 90% nylon, 10% tecido elástico, 265 g/m², tecido reforçado nos joelhos e na parte de trás, bainhas elásticas com fecho vertical
Cinza escuro, com detalhes em verde fluorescente
Slim fit

CE

TREKKING
HEAVY



XXXXXX	I	€	U	U
XS	46	77,00	1	076000000
S	48	77,00	1	076000001
M	50	77,00	1	076000002
L	52	77,00	1	076000003
XL	54	77,00	1	076000004
XXL	56	77,00	1	076000005
XXXL	58	77,00	1	076000006

7600N

calças "work trekking", PESADAS, 90% nylon, 10% tecido elástico, 265 g/m², joelhos e parte traseira reforçados, bainhas elásticas com fecho vertical
Cinza escuro, com detalhes em verde fluorescente
Slim fit

CE

TREKKING
HEAVY



XXXXXX	I	€	U	U
XS	46	77,00	1	076000100
S	48	77,00	1	076000101
M	50	77,00	1	076000102
L	52	77,00	1	076000103
XL	54	77,00	1	076000104
XXL	56	77,00	1	076000105
XXXL	58	77,00	1	076000106

7610G

calças "work trekking" LIGHT , 90% nylon, tecido 10% tecido elástico, 140 g/m², reforço nos joelhos e parte traseira, cordão e bainhas em tecido stretch.

Cinza escuro com detalhes em amarelo.

Slim fit

CE



	I	€		
XS	46	74,50	1	076100000
S	48	74,50	1	076100001
M	50	74,50	1	076100002
L	52	74,50	1	076100003
XL	54	74,50	1	076100004
XXL	56	74,50	1	076100005
XXXL	58	74,50	1	076100006

7650

calças de trabalho elásticas, estilo multibolsos 90% nylon - 10% elastano, 260 g/m², cinzento antracite

Reforços em poliéster 600D nos joelhos, bolsos traseiros e bainhas. Entrepernas reforçado.

CE



	I	€		
XS	46	97,00	1	076500000
S	48	97,00	1	076500001
M	50	97,00	1	076500002
L	52	97,00	1	076500003
XL	54	97,00	1	076500004
XXL	56	97,00	1	076500005
XXXL	58	97,00	1	076500006

7660B

calças de trabalho elásticas, leves, estilo multibolsos, 86% nylon - 14% elastano, 140 g/m², azul bolsos nos joelhos, bolsos traseiros reforçados em poliéster 300D, entrepernas reforçado Slim fit

CE



	I	€		
XS	46	83,50	1	076600100
S	48	83,50	1	076600101
M	50	83,50	1	076600102
L	52	83,50	1	076600103
XL	54	83,50	1	076600104
XXL	56	83,50	1	076600105
XXXL	58	83,50	1	076600106

7610N

calças "work trekking" LIGHT , 90% nylon, tecido 10% tecido elástico, 140 g/m², reforço nos joelhos e parte traseira, cordão e bainhas em tecido stretch.

Preto com detalhes em amarelo.

Slim fit

CE



	I	€		
XS	46	74,50	1	076100100
S	48	74,50	1	076100101
M	50	74,50	1	076100102
L	52	74,50	1	076100103
XL	54	74,50	1	076100104
XXL	56	74,50	1	076100105
XXXL	58	74,50	1	076100106

7650B

calças de trabalho elásticas, estilo multibolsos, 90% nylon - 10% elastano, 260 g/m², azul Bolsos nos joelhos, bolsos traseiros e bainhas reforçados em poliéster 600D, entrepernas reforçado

CE



	I	€		
XS	46	97,00	1	076500100
S	48	97,00	1	076500101
M	50	97,00	1	076500102
L	52	97,00	1	076500103
XL	54	97,00	1	076500104
XXL	56	97,00	1	076500105
XXXL	58	97,00	1	076500106

7660G

calças de trabalho elásticas, leves, estilo multibolsos, 86% nylon - 14% elastano, 140 g/m², cinza antracite bolsos nos joelhos, bolsos traseiros reforçados em poliéster 300D, entrepernas reforçado Slim fit

CE



	I	€		
XS	46	83,50	1	076600000
S	48	83,50	1	076600001
M	50	83,50	1	076600002
L	52	83,50	1	076600003
XL	54	83,50	1	076600004
XXL	56	83,50	1	076600005
XXXL	58	83,50	1	076600006

7818G

calças de trabalho, estilo multi-bolsos, em lona T/C, 260 g/m², cinza

Bolsos acolchoados nos joelhos e bainhas reforçadas em poliéster 300D, entrepernas à prova de desgaste e com inserção de tecido elástico; região lombar com elástico para facilidade de movimentos

CE



XS	46	€	1	078180000
S	48	74,50	1	078180001
M	50	74,50	1	078180002
L	52	74,50	1	078180003
XL	54	74,50	1	078180004
XXL	56	74,50	1	078180005
XXXL	58	74,50	1	078180006

7818BL

calças de trabalho, estilo multi-bolsos, em lona T/C, 260 g/m², azuis

Com inserção de tecido elástico entrepernas Bolsos acolchoados nos joelhos e bainhas reforçadas em poliéster 300D, entrepernas à prova de desgaste e com inserção de tecido elástico; região lombar com elástico para facilidade de movimentos

CE



XS	46	€	1	078180100
S	48	74,50	1	078180101
M	50	74,50	1	078180102
L	52	74,50	1	078180103
XL	54	74,50	1	078180104
XXL	56	74,50	1	078180105
XXXL	58	74,50	1	078180106

7818CM

calças de trabalho, estilo multi-bolsos, tecido em lona de algodão, 260 g/m², camuflado cinzento

Bolsos tipo joelheiras e bainhas reforçadas em poliéster 300D, entrepernas à prova de rasgões e inserções de tecido elástico no interior da perna e na região lombar para movimentos mais fáceis

CE



XS	46	€	1	078180300
S	48	79,00	1	078180301
M	50	79,00	1	078180302
L	52	79,00	1	078180303
XL	54	79,00	1	078180304
XXL	56	79,00	1	078180305
XXXL	58	79,00	1	078180306

7818LN

calças de trabalho para mulher, estilo multi-bolsos, pretas com detalhes rosa, 100% algodão elástico, 220 g/m² Bolsos acolchoados nos joelhos e bainhas reforçadas em poliéster 300D, entrepernas à prova de desgaste e com inserção de tecido elástico; região lombar com elástico para facilidade de movimentos

CE



XS	38	€	1	078180200
S	40	74,50	1	078180201
M	42	74,50	1	078180202
L	44	74,50	1	078180203
XL	46	74,50	1	078180204
XXL	48	74,50	1	078180205
XXXL	50	74,50	1	078180206

7819G

calças de trabalho, estilo multibolsos, com bolsos amovíveis, lona T/C, 260 g/m², cinza

160 / 5 000 Resultados da tradução Resultado de tradução Bolsos acolchoados nos joelhos e bainhas reforçadas em poliéster 300D, entrepernas antidesgaste e aplicações em tecido elástico na parte interna das pernas e na região lombar para facilitar os movimentos

CE



XS	46	€	1	078190000
S	48	74,50	1	078190001
M	50	74,50	1	078190002
L	52	74,50	1	078190003
XL	54	74,50	1	078190004
XXL	56	74,50	1	078190005
XXXL	58	74,50	1	078190006

7830SN

calças de trabalho elásticas, em sarja T/C, 200 g/m², pretas Modelo ajustado, entrepernas à prova de desgaste e cintura elástica nas laterais

CE



XS	46	€	1	078300100
S	48	66,50	1	078300101
M	50	66,50	1	078300102
L	52	66,50	1	078300103
XL	54	66,50	1	078300104
XXL	56	66,50	1	078300105
XXXL	58	66,50	1	078300106

7830ST

calças de trabalho stretch, sarja T/C, 250 g/m², cinzento
Slim fit, entre-pernas reforçado e cintura elástica dos lados

CE



	I	€		
XS	46	66,50	1	078300000
S	48	66,50	1	078300001
M	50	66,50	1	078300002
L	52	66,50	1	078300003
XL	54	66,50	1	078300004
XXL	56	66,50	1	078300005
XXXL	58	66,50	1	078300006

7840BL

calças de trabalho em lona T/C, 245 g/m², azul
Cintura elástica dos lados

CE

Beta EASY



	I	€		
XS	46	42,50	1	078400100
S	48	42,50	1	078400101
M	50	42,50	1	078400102
L	52	42,50	1	078400103
XL	54	42,50	1	078400104
XXL	56	42,50	1	078400105
XXXL	58	42,50	1	078400106
XXXXL	60	42,50	1	078400107

7850G

calças de trabalho cargo, 100% algodão, 240 g/m²,
cós elástico nas laterais e bolsos laterais grandes com aplicações refletoras,
cinza com detalhes em verde fluorescente
Slim fit

CE



	I	€		
XS	46	48,00	1	078500100
S	48	48,00	1	078500101
M	50	48,00	1	078500102
L	52	48,00	1	078500103
XL	54	48,00	1	078500104
XXL	56	48,00	1	078500105
XXXL	58	48,00	1	078500106
XXXXL	60	48,00	1	078500107

7860B

calças de trabalho, leves, em sarja T/C, 180 g/m², aplicações em poliéster "Oxford", azuis

CE



	I	€		
XS	46	55,00	1	078600700
S	48	55,00	1	078600701
M	50	55,00	1	078600702
L	52	55,00	1	078600703
XL	54	55,00	1	078600704
XXL	56	55,00	1	078600705
XXXL	58	55,00	1	078600706
XXXXL	60	55,00	1	078600707
5XL	62	55,00	1	078600708

7860G

calças de trabalho, linha light, em sarja T/C 180 g/m², aplicações "Oxford", cinza.
Novo design, corte aperfeiçoado.

CE

Beta EASY

LIGHT



	I	€		
XS	46	55,00	1	078600800
S	48	55,00	1	078600801
M	50	55,00	1	078600802
L	52	55,00	1	078600803
XL	54	55,00	1	078600804
XXL	56	55,00	1	078600805
XXXL	58	55,00	1	078600806
XXXXL	60	55,00	1	078600807
5XL	62	55,00	1	078600808

7880SC

calças de trabalho stretch, sarja T/C, 290 g/m², preto
Slim fit, entre-pernas reforçado e cintura elástica dos lados

CE



	I	€		
XS	46	67,50	1	078800000
S	48	67,50	1	078800001
M	50	67,50	1	078800002
L	52	67,50	1	078800003
XL	54	67,50	1	078800004
XXL	56	67,50	1	078800005
XXXL	58	67,50	1	078800006

7900B

calças de trabalho, em lona T/C, 260 g/m², aplicações "Oxford", azul

CE

Beta EASY



Medida	I	€	U	Art
XS	46	61,00	1	079000700
S	48	61,00	1	079000701
M	50	61,00	1	079000702
L	52	61,00	1	079000703
XL	54	61,00	1	079000704
XXL	56	61,00	1	079000705
XXXL	58	61,00	1	079000706
XXXXL	60	61,00	1	079000707

7900G

calças de trabalho em lona T/C, 260 g/m², aplicações "Oxford", cinzento. Novo design, corte aperfeiçoado.

CE

Beta EASY



Medida	I	€	U	Art
XS	46	61,00	1	079000800
S	48	61,00	1	079000801
M	50	61,00	1	079000802
L	52	61,00	1	079000803
XL	54	61,00	1	079000804
XXL	56	61,00	1	079000805
XXXL	58	61,00	1	079000806
XXXXL	60	61,00	1	079000807

7900P

calças de trabalho, em lona T/C, 260 g/m², aplicações "Oxford", azul petróleo

CE

Beta EASY



Medida	I	€	U	Art
XS	46	61,00	1	079000600
S	48	61,00	1	079000601
M	50	61,00	1	079000602
L	52	61,00	1	079000603
XL	54	61,00	1	079000604
XXL	56	61,00	1	079000605
XXXL	58	61,00	1	079000606
XXXXL	60	61,00	1	079000607

7900V

calças de trabalho, em lona T/C, 260 g/m², aplicações "Oxford", verde

CE

Beta EASY



Medida	I	€	U	Art
XS	46	61,00	1	079000500
S	48	61,00	1	079000501
M	50	61,00	1	079000502
L	52	61,00	1	079000503
XL	54	61,00	1	079000504
XXL	56	61,00	1	079000505
XXXL	58	61,00	1	079000506
XXXXL	60	61,00	1	079000507

7930MG

calças de trabalho, estilo multibolsos, 97% algodão, 3% elastano, 220 g/m², cinza

CE

Cotton



Medida	I	€	U	Art
XS	46	62,00	1	079300400
S	48	62,00	1	079300401
M	50	62,00	1	079300402
L	52	62,00	1	079300403
XL	54	62,00	1	079300404
XXL	56	62,00	1	079300405
XXXL	58	62,00	1	079300406

7940

calças de trabalho multi-proteção sarja T/C, 250 g/m², azul, para proteção contra calor, chamas, efeitos de arco elétrico, perigos decorrentes de soldadura e produtos químicos.

CE



DPI: IIIª Categoria
EN ISO 11611:2015 - Classe 1
EN ISO 11612:2015 - A1 B1
C1
EN 1149-5:2018
EN13034:2005+A1:2009
- Type 6
IEC 61482-2:2018 - APC 1

Medida	I	€	U	Art
XS	46	88,50	1	079400000
S	48	88,50	1	079400001
M	50	88,50	1	079400002
L	52	88,50	1	079400003
XL	54	88,50	1	079400004
XXL	56	88,50	1	079400005
XXXL	58	88,50	1	079400006
XXXXL	60	88,50	1	079400007

BERMUDA



7529

Calções de trabalho em ganga elástica, 98% algodão, 2% elastano, modelo slim

CE

Jeans



	I	€		
XS	46	49,50	1	075290046
S	48	49,50	1	075290048
M	50	49,50	1	075290050
L	52	49,50	1	075290052
XL	54	49,50	1	075290054
XXL	56	49,50	1	075290056
XXXL	58	49,50	1	075290058

7611G

calções tipo bermudas "work trekking" LIGHT, 90% nylon, 10% tecido elástico, 140 g/m², tecido reforçado na parte traseira. Cinza escuro com detalhes em amarelo. Slim fit

CE

TREKING
LIGHT



	I	€		
XS	46	57,00	1	076110000
S	48	57,00	1	076110001
M	50	57,00	1	076110002
L	52	57,00	1	076110003
XL	54	57,00	1	076110004
XXL	56	57,00	1	076110005
XXXL	58	57,00	1	076110006

7661B

bermudas de trabalho elásticas, leves, estilo multibolsos, 86% nylon - 14% elastano, 140 g/m², azul bolsos traseiros reforçados em poliéster 300D, entrepernas reforçado Slim fit

CE



	I	€		
XS	46	72,50	1	076610100
S	48	72,50	1	076610101
M	50	72,50	1	076610102
L	52	72,50	1	076610103
XL	54	72,50	1	076610104
XXL	56	72,50	1	076610105
XXXL	58	72,50	1	076610106

7661G

bermudas de trabalho elásticas, leves, estilo multibolsos, 86% nylon - 14% elastano, 140 g/m², cinza antracite bolsos traseiros reforçados em poliéster 300D, entrepernas reforçado Slim fit

CE



	I	€		
XS	46	72,50	1	076610000
S	48	72,50	1	076610001
M	50	72,50	1	076610002
L	52	72,50	1	076610003
XL	54	72,50	1	076610004
XXL	56	72,50	1	076610005
XXXL	58	72,50	1	076610006



7815CM

calções de trabalho tipo bermudas, estilo multi-bolsos, tecido em lona de algodão, 260 g/m², camuflado cinzento, entrepernas à prova de rasgões e inserções de tecido elástico no interior da perna e na região lombar para movimentos mais fáceis

CE



	I	€		
XS	46	62,00	1	078150300
S	48	62,00	1	078150301
M	50	62,00	1	078150302
L	52	62,00	1	078150303
XL	54	62,00	1	078150304
XXL	56	62,00	1	078150305
XXXL	58	62,00	1	078150306

7831SN

calções Bermuda elásticos, em sarja T/C, 200 g/m², pretos Modelo ajustado, entrepernas à prova de desgaste e cintura elástica nas laterais

CE



	I	€		
XS	46	50,50	1	078310100
S	48	50,50	1	078310101
M	50	50,50	1	078310102
L	52	50,50	1	078310103
XL	54	50,50	1	078310104
XXL	56	50,50	1	078310105
XXXL	58	50,50	1	078310106

7831ST

bermudas de trabalho stretch, sarja T/C, 250 g/m², cinzento Slim fit, entre-pernas reforçado e cintura elástica dos lados

CE



	I	€		
XS	46	50,50	1	078310000
S	48	50,50	1	078310001
M	50	50,50	1	078310002
L	52	50,50	1	078310003
XL	54	50,50	1	078310004
XXL	56	50,50	1	078310005
XXXL	58	50,50	1	078310006

7861G

calções de trabalho, linha light, em sarja T/C, 180 g/m², com aplicações "Oxford", cinza.
Novo design, corte aperfeiçoado.

Beta EASY

CE

LIGHT



XS	46	€	45,50	1	078610800
S	48	€	45,50	1	078610801
M	50	€	45,50	1	078610802
L	52	€	45,50	1	078610803
XL	54	€	45,50	1	078610804
XXL	56	€	45,50	1	078610805
XXXL	58	€	45,50	1	078610806
XXXXL	60	€	45,50	1	078610807
5XL	62	€	45,50	1	078610808

7861B

calções bermudas de trabalho, leves, em sarja T/C, 180 g/m², aplicações em poliéster "Oxford", azuis

CE

Beta EASY

LIGHT



XS	46	€	45,50	1	078610700
S	48	€	45,50	1	078610701
M	50	€	45,50	1	078610702
L	52	€	45,50	1	078610703
XL	54	€	45,50	1	078610704
XXL	56	€	45,50	1	078610705
XXXL	58	€	45,50	1	078610706
XXXXL	60	€	45,50	1	078610707
5XL	62	€	45,50	1	078610708

Beta

7901G

bermudas de trabalho, lona T/C, 260 g/m², aplicações "Oxford", cinzento.
Novo design, corte aperfeiçoado.

Beta EASY

CE



XS	46	€	49,00	1	079010800
S	48	€	49,00	1	079010801
M	50	€	49,00	1	079010802
L	52	€	49,00	1	079010803
XL	54	€	49,00	1	079010804
XXL	56	€	49,00	1	079010805
XXXL	58	€	49,00	1	079010806
XXXXL	60	€	49,00	1	079010807

7931MG

calções bermudas de trabalho, 97% algodão, 3% elastano, 220 g/m², cinza

CE

Cotton



XS	46	€	49,50	1	079310400
S	48	€	49,50	1	079310401
M	50	€	49,50	1	079310402
L	52	€	49,50	1	079310403
XL	54	€	49,50	1	079310404
XXL	56	€	49,50	1	079310405
XXXL	58	€	49,50	1	079310406

OVERALLS

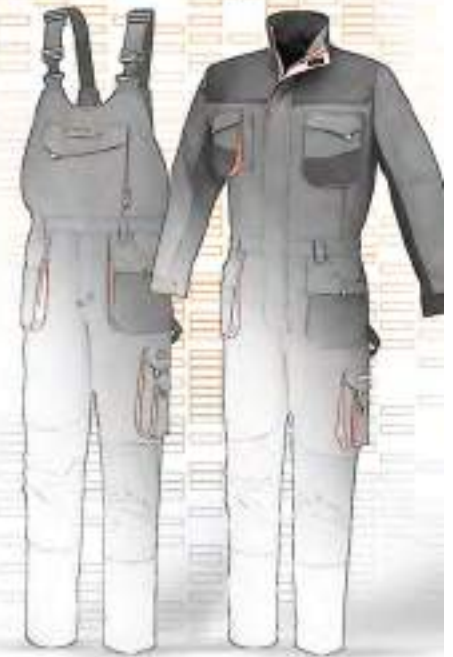

7863G

jardineiras de trabalho, leves, em sarja T/C, 180 g/m², aplicações em poliéster Oxford, cinza.
Novo design, corte aperfeiçoado.

Beta EASY

CE

LIGHT



XS	€	67,50	1	078630800
S	€	67,50	1	078630801
M	€	67,50	1	078630802
L	€	67,50	1	078630803
XL	€	67,50	1	078630804
XXL	€	67,50	1	078630805
XXXL	€	67,50	1	078630806
XXXXL	€	67,50	1	078630807
5XL	€	67,50	1	078630808

7903G

jardineiras de trabalho, em lona T/C, 260 g/m², com aplicações "Oxford", cinzento.
Novo design, corte aperfeiçoado

CE

Beta EASY



	€		
XS	76,50	1	079030800
S	76,50	1	079030801
M	76,50	1	079030802
L	76,50	1	079030803
XL	76,50	1	079030804
XXL	76,50	1	079030805
XXXL	76,50	1	079030806
XXXXL	76,50	1	079030807

7903P

jardineiras de trabalho, em lona T/C, 260 g/m², aplicações em "Oxford", azul petróleo

CE

Beta EASY



	€		
XS	76,50	1	079030600
S	76,50	1	079030601
M	76,50	1	079030602
L	76,50	1	079030603
XL	76,50	1	079030604
XXL	76,50	1	079030605
XXXL	76,50	1	079030606
XXXXL	76,50	1	079030607

7865B

macacão de trabalho, leve, em sarja T/C, 180 g/m², aplicações em poliéster "Oxford", azul

CE

Beta EASY



	€		
XS	87,50	1	078650700
S	87,50	1	078650701
M	87,50	1	078650702
L	87,50	1	078650703
XL	87,50	1	078650704
XXL	87,50	1	078650705
XXXL	87,50	1	078650706
XXXXL	87,50	1	078650707
5XL	87,50	1	078650708

7865G

macacão de trabalho, leve, sarja T/C, 180 g/m², aplicações em poliéster "Oxford", cinza.
Novo design, corte aperfeiçoado.

CE

Beta EASY



	€		
XS	87,50	1	078650800
S	87,50	1	078650801
M	87,50	1	078650802
L	87,50	1	078650803
XL	87,50	1	078650804
XXL	87,50	1	078650805

	€		
XXXL	87,50	1	078650806
XXXXL	87,50	1	078650807
5XL	87,50	1	078650808

7905G

macacão de trabalho, lona T/C, 260 g/m², aplicações em poliéster "Oxford", cinza.
Novo design, corte aperfeiçoado.

CE

Beta EASY



	€		
XS	95,00	1	079050800
S	95,00	1	079050801
M	95,00	1	079050802
L	95,00	1	079050803
XL	95,00	1	079050804
XXL	95,00	1	079050805
XXXL	95,00	1	079050806
XXXXL	95,00	1	079050807

7935MG

macacão de trabalho, 97% algodão, 3% elastano, 220 g/m², cinza

CE

Cotton



	€		
XS	109,00	1	079350400
S	109,00	1	079350401
M	109,00	1	079350402
L	109,00	1	079350403
XL	109,00	1	079350404
XXL	109,00	1	079350405
XXXL	109,00	1	079350406

WORK JACKETS



7653G

casaco de trabalho elástico, multibolsos, 90% nylon, 10% elastano, 260 g/m², cinza antracite.

CE



XS	€	1	076530000
XS	97,50	1	076530000
S	97,50	1	076530001
M	97,50	1	076530002
L	97,50	1	076530003
XL	97,50	1	076530004
XXL	97,50	1	076530005
XXXL	97,50	1	076530006

7849BL

casaco de trabalho em lona T/C, 245 g/m², azul
Elástico na cintura

CE

Beta EASY



XS	€	1	078490100
XS	45,50	1	078490100
S	45,50	1	078490101
M	45,50	1	078490102
L	45,50	1	078490103
XL	45,50	1	078490104
XXL	45,50	1	078490105
XXXL	45,50	1	078490106
XXXXL	45,50	1	078490107

7869G

casaco de trabalho, leve, em sarja T/C, 180 g/m², aplicações "Oxford", cinzento.
Novo design, corte aperfeiçoado.

CE

Beta EASY



XS	€	1	078690800
XS	59,50	1	078690800
S	59,50	1	078690801
M	59,50	1	078690802
L	59,50	1	078690803
XL	59,50	1	078690804
XXL	59,50	1	078690805
XXXL	59,50	1	078690806
XXXXL	59,50	1	078690807
5XL	59,50	1	078690808

7909B

casaco de trabalho, em lona T/C, 260 g/m², aplicações em "Oxford", azul

CE

Beta EASY



XS	€	1	079090700
XS	67,50	1	079090700
S	67,50	1	079090701
M	67,50	1	079090702
L	67,50	1	079090703
XL	67,50	1	079090704
XXL	67,50	1	079090705
XXXL	67,50	1	079090706
XXXXL	67,50	1	079090707

7909G

casaco de trabalho, em lona T/C, 260 g/m², aplicações "Oxford", cinzento.
Novo design, corte aperfeiçoado.

CE

Beta EASY



XS	€	1	079090800
XS	67,50	1	079090800
S	67,50	1	079090801
M	67,50	1	079090802
L	67,50	1	079090803
XL	67,50	1	079090804
XXL	67,50	1	079090805
XXXL	67,50	1	079090806
XXXXL	67,50	1	079090807

7909P

casaco de trabalho, em lona T/C, 260 g/m², aplicações em "Oxford", azul petróleo

CE

Beta EASY



XS	€	1	079090600
XS	67,50	1	079090600
S	67,50	1	079090601
M	67,50	1	079090602
L	67,50	1	079090603
XL	67,50	1	079090604
XXL	67,50	1	079090605
XXXL	67,50	1	079090606
XXXXL	67,50	1	079090607

7909V

casaco de trabalho, em lona T/C, 260g/m², aplicações "Oxford", verde

CE

Beta EASY



XS	€	1	079090500
XS	67,50	1	079090500
S	67,50	1	079090501
M	67,50	1	079090502
L	67,50	1	079090503
XL	67,50	1	079090504
XXL	67,50	1	079090505
XXXL	67,50	1	079090506
XXXXL	67,50	1	079090507



7949

casaco de trabalho multi-proteção, sarja T/C, 250 g/m², azul, para proteção contra calor, chamas, efeitos de arco elétrico, perigos decorrentes de soldadura e produtos químicos.

CE

DPI: IIIª Categoria
EN ISO 11611:2015 - Classe 1
EN ISO 11612:2015 - A1 B1 C1
EN 1149-5:2018
EN13034:2005+A1:2009 - Type 6
IEC 61482-2:2018 - APC 1



Medida	€	Unidade	Artigo
XS	102,00	1	079490000
S	102,00	1	079490001
M	102,00	1	079490002
L	102,00	1	079490003
XL	102,00	1	079490004
XXL	102,00	1	079490005
XXXL	102,00	1	079490006
XXXXL	102,00	1	079490007

SLEEVELESS JACKETS



7575N

Colete em tecido softshell, 90% nylon, 10% tecido elástico, 250 g/m²



Medida	€	Unidade	Artigo
S	89,50	1	075750301
M	89,50	1	075750302
L	89,50	1	075750303
XL	89,50	1	075750304
XXL	89,50	1	075750305
XXXL	89,50	1	075750306

7579QN

Colete de trabalho, estilo multi-bolsos, composto por dois materiais 100% nylon 300D impermeável e tecido softshell, 96% poliéster, 4% elastano, acolchoado em poliéster, 160 g/m². Preto/cinza antracite

CE



Medida	€	Unidade	Artigo
S	77,50	1	075790201
M	77,50	1	075790202
L	77,50	1	075790203
XL	77,50	1	075790204
XXL	77,50	1	075790205
XXXL	77,50	1	075790206

7673NG

colete de trabalho com acolchoado GRAPHENE, 80 g/m², frente reforçada em tecido softshell - 96% poliéster, 4% elastano; costas 100% nylon 20D
cinza antracite (frente), preto (costas)
Inserts elásticos nas cavas
Antiestático, antibacteriano, corta-vento

CE



Medida	€	Unidade	Artigo
S	98,50	1	076730001
M	98,50	1	076730002
L	98,50	1	076730003
XL	98,50	1	076730004
XXL	98,50	1	076730005
XXXL	98,50	1	076730006

Beta

7867B

colete de trabalho, leve, em sarja T/C, 180 g/m², aplicações em poliéster "Oxford", azul

CE



Medida	€	Unidade	Artigo
XS	51,00	1	078670700
S	51,00	1	078670701
M	51,00	1	078670702
L	51,00	1	078670703
XL	51,00	1	078670704
XXL	51,00	1	078670705
XXXL	51,00	1	078670706
XXXXL	51,00	1	078670707
5XL	51,00	1	078670708

7867G

colete de trabalho, leve, em sarja TC, 180 g/m², aplicações em poliéster "Oxford", cinza. Novo design, corte aperfeiçoado.

CE



Medida	€	Unidade	Artigo
XS	51,00	1	078670800
S	51,00	1	078670801
M	51,00	1	078670802
L	51,00	1	078670803
XL	51,00	1	078670804
XXL	51,00	1	078670805
XXXL	51,00	1	078670806
XXXXL	51,00	1	078670807
5XL	51,00	1	078670808

7907G

colete de trabalho, em lona T/C, 260 g/m², aplicações em "Oxford", cinza.
Novo design, corte aperfeiçoado.

CE

Beta EASY



	€		
XS	56,50	1	079070800
S	56,50	1	079070801
M	56,50	1	079070802
L	56,50	1	079070803
XL	56,50	1	079070804
XXL	56,50	1	079070805
XXXL	56,50	1	079070806
XXXXL	56,50	1	079070807

7937MG

colete de trabalho, 97% algodão, 3% elastano, 220 g/m², cinza

CE

Cotton



	€		
XS	57,50	1	079370400
S	57,50	1	079370401
M	57,50	1	079370402
L	57,50	1	079370403
XL	57,50	1	079370404
XXL	57,50	1	079370405
XXXL	57,50	1	079370406

JACKETS



7658CM

casaco softshell, 94% poliéster, 6% elastano, 290 g/m², cinza camuflagem
Com membrana impermeável, corta-vento, TPU respirável
(resistência a colunas de água até 8,000 mm - respirabilidade 8,000 mvp)

TOP line



	€		
S	123,00	1	076580101
M	123,00	1	076580102
L	123,00	1	076580103
XL	123,00	1	076580104
XXL	123,00	1	076580105
XXXL	123,00	1	076580106

7659N

casaco softshell, 94% poliéster, 6% elastano, 290 g/m², com capuz e mangas amovíveis, preto
Com membrana TPU, impermeável, à prova de vento e respirável (resistente a colunas de água até 8,000 mm - respirabilidade 8,000 mvp)

TOP line



	€		
S	158,00	1	076590001
M	158,00	1	076590002
L	158,00	1	076590003
XL	158,00	1	076590004
XXL	158,00	1	076590005
XXXL	158,00	1	076590006

7669N

casaco de trabalho elástico, leve, estilo multibolsos, 86% nylon, 14% elastano, 140 g-m², preto
com mangas amovíveis e capuz desdobrável, impermeável, corta-vento

4-WAY STRETCH
TOP line



	€		
XS	110,00	1	076690000
S	110,00	1	076690001
M	110,00	1	076690002
L	110,00	1	076690003
XL	110,00	1	076690004
XXL	110,00	1	076690005
XXXL	110,00	1	076690006

7670G

casaco Anorak em poliéster Oxford 300D, impermeável, revestimento PU, cinza antracite
Com capuz amovível e mangas reforçadas. Impermeável, corta-vento e respirável (resistência a colunas de água até 2,000 mm - respirabilidade 2,000 mvp)
forro poliéster 210T, acolchoado poliéster, corpo 120 g/m², mangas 100 g/m²s

CE

TOP line



	€		
S	110,00	1	076700001
M	110,00	1	076700002
L	110,00	1	076700003
XL	110,00	1	076700004
XXL	110,00	1	076700005
XXXL	110,00	1	076700006

Beta

Beta



7674NG

blusão de trabalho com acolchoado GRAPHENE, 80 g/m², frente e antebraços reforçados em tecido softshell - 96% poliéster, 4% elastano, costas e mangas 100% nylon 20D cinza antracite (frente), preto (costas) punhos elásticos Antiestático, Antibacteriano, Corta-vento

CE TOP



	€		
S	123,00	1	076740001
M	123,00	1	076740002
L	123,00	1	076740003
XL	123,00	1	076740004
XXL	123,00	1	076740005
XXXL	123,00	1	076740006

7780QN

• Blusão de trabalho, estilo multi-bolsos, confeccionado com duplo material. • 100% nylon impermeável 300D e tecido softshell, 96% poliéster, 4% elastano, acolchoado em poliéster, 160 g/m² com capuz fixo • preto/cinza antracite

CE



	€		
S	131,00	1	077800201
M	131,00	1	077800202
L	131,00	1	077800203
XL	131,00	1	077800204
XXL	131,00	1	077800205
XXXL	131,00	1	077800206

7750N

casaco de trabalho, estilo multibolsos, 100% poliéster, acolchoamento 100% poliéster, 120 g/m², preto

CE



	€		
XS	82,50	1	077500000
S	82,50	1	077500001
M	82,50	1	077500002
L	82,50	1	077500003
XL	82,50	1	077500004
XXL	82,50	1	077500005
XXXL	82,50	1	077500006

FLEECE



7636N

camisola em microfibra, com fecho curto, 180 g/m² preta com detalhes refletivos



	€		
XS	27,00	1	076360500
S	27,00	1	076360501
M	27,00	1	076360502
L	27,00	1	076360503
XL	27,00	1	076360504
XXL	27,00	1	076360505
XXXL	27,00	1	076360506

7637G

Sweatshirt técnica, fecho de correr longo, 250 g/m², com capuz, em lã, 100% poliéster, inserções em tecido softshell 100D, com tecido polar, 270 g/m² mesclado cinza/preto



	€		
XS	87,00	1	076370000
S	87,00	1	076370001
M	87,00	1	076370002
L	87,00	1	076370003
XL	87,00	1	076370004
XXL	87,00	1	076370005
XXXL	87,00	1	076370006

7642G

sweatshirt de gola redonda, 240 g/m², 60% algodão, 40% poliéster, cinza melange, aplicações pretas



	€		
XS	33,00	1	076420000
S	33,00	1	076420001
M	33,00	1	076420002
L	33,00	1	076420003
XL	33,00	1	076420004
XXL	33,00	1	076420005
XXXL	33,00	1	076420006

7654B

Camisola polar, fecho de correr curto, 180 g/m², azul 95% poliéster, 5% elastano



	€		
XS	46,50	1	076540100
S	46,50	1	076540101
M	46,50	1	076540102
L	46,50	1	076540103
XL	46,50	1	076540104
XXL	46,50	1	076540105
XXXL	46,50	1	076540106

7654N

sweater em micropolar elástico, fecho curto de correr, 180 g/m², preto
95% poliéster, 5% elastano



XS	€	👤	📦
XS	46,50	1	076540000
S	46,50	1	076540001
M	46,50	1	076540002
L	46,50	1	076540003
XL	46,50	1	076540004
XXL	46,50	1	076540005
XXXL	46,50	1	076540006

7657B

Casaco polar, fecho de correr comprido, 280 g/m², azul
95% poliéster, 5% elastano



XS	€	👤	📦
XS	59,50	1	076570100
S	59,50	1	076570101
M	59,50	1	076570102
L	59,50	1	076570103
XL	59,50	1	076570104
XXL	59,50	1	076570105
XXXL	59,50	1	076570106

7657N

sweater em polar elástico, fecho comprido de correr, 280 g/m², preto
95% poliéster, 5% elastano



XS	€	👤	📦
XS	59,50	1	076570000
S	59,50	1	076570001
M	59,50	1	076570002
L	59,50	1	076570003
XL	59,50	1	076570004
XXL	59,50	1	076570005
XXXL	59,50	1	076570006

7664C

sweatshirt, fecho de correr comprido, 280 g/m², cinza
60% algodão, 40% poliéster



XS	€	👤	📦
XS	54,50	1	076640100
S	54,50	1	076640101
M	54,50	1	076640102
L	54,50	1	076640103
XL	54,50	1	076640104
XXL	54,50	1	076640105
XXXL	54,50	1	076640106

7664N

sweatshirt, fecho de correr comprido, 280 g/m², preto
60% algodão, 40% poliéster



XS	€	👤	📦
XS	54,50	1	076640000
S	54,50	1	076640001
M	54,50	1	076640002
L	54,50	1	076640003
XL	54,50	1	076640004
XXL	54,50	1	076640005
XXXL	54,50	1	076640006

7665G

camisola com capuz, fecho de correr comprido, 280 g/m², cinza
60% algodão, 40% poliéster



XS	€	👤	📦
XS	58,50	1	076650100
S	58,50	1	076650101
M	58,50	1	076650102
L	58,50	1	076650103
XL	58,50	1	076650104
XXL	58,50	1	076650105
XXXL	58,50	1	076650106

7665N

camisola com capuz, fecho de correr comprido, 280 g/m², preto
60% algodão, 40% poliéster



XS	€	👤	📦
XS	58,50	1	076650000
S	58,50	1	076650001
M	58,50	1	076650002
L	58,50	1	076650003
XL	58,50	1	076650004
XXL	58,50	1	076650005
XXXL	58,50	1	076650006

SHIRT & T-SHIRT

7545F

camisa de xadrez em flanela, 100% algodão, 190 g/m²



XS	€	👤	📦
XS	41,50	1	075450200
S	41,50	1	075450201
M	41,50	1	075450202
L	41,50	1	075450203
XL	41,50	1	075450204
XXL	41,50	1	075450205
XXXL	41,50	1	075450206

7547AZ

camisola tipo polo com três botões, 100% algodão, 200 g/m², azul



XS	€	👤	📦
XS	30,00	2	075470500
S	30,00	2	075470501
M	30,00	2	075470502
L	30,00	2	075470503
XL	30,00	2	075470504
XXL	30,00	2	075470505
XXXL	30,00	2	075470506

7547BL

polo de três botões
100% algodão, 200 g/m², azul



	€		
XS	30,00	2	075470200
S	30,00	2	075470201
M	30,00	2	075470202
L	30,00	2	075470203
XL	30,00	2	075470204
XXL	30,00	2	075470205
XXXL	30,00	2	075470206

7547G

polo de três botões
100% algodão, 200 g/m², cinzento



	€		
XS	30,00	2	075470300
S	30,00	2	075470301
M	30,00	2	075470302
L	30,00	2	075470303
XL	30,00	2	075470304
XXL	30,00	2	075470305
XXXL	30,00	2	075470306

7547N

polo de três botões
100% algodão, 200 g/m², preto



	€		
XS	30,00	2	075470400
S	30,00	2	075470401
M	30,00	2	075470402
L	30,00	2	075470403
XL	30,00	2	075470404
XXL	30,00	2	075470405
XXXL	30,00	2	075470406

7547R

camisola tipo polo com três botões,
100% algodão, 200 g/m², vermelho



	€		
XS	30,00	2	075470600
S	30,00	2	075470601
M	30,00	2	075470602
L	30,00	2	075470603
XL	30,00	2	075470604
XXL	30,00	2	075470605
XXXL	30,00	2	075470606

7548M

t-shirt estampado moderno, 100% algodão,
150 g/m²



	€		
XS	26,00	1	075480400
XL	26,00	1	075480404
S	26,00	1	075480401
M	26,00	1	075480402
L	26,00	1	075480403
XXL	26,00	1	075480405
XXXL	26,00	1	075480406

7548C

t-shirt estampado clássico, 100% algodão, 150
g/m²



	€		
XS	26,00	1	075480500
S	26,00	1	075480501
M	26,00	1	075480502
L	26,00	1	075480503
XL	26,00	1	075480504
XXL	26,00	1	075480505
XXXL	26,00	1	075480506

7549AZ

t-shirt de trabalho, 100% algodão, 150 g/m²,
azul



	€		
XS	19,70	5	075490500
S	19,70	5	075490501
M	19,70	5	075490502
L	19,70	5	075490503
XL	19,70	5	075490504
XXL	19,70	5	075490505
XXXL	19,70	5	075490506

7549BL

t-shirt de trabalho, 100% algodão, 150g/m²,
azul



	€		
XS	19,70	5	075490200
S	19,70	5	075490201
M	19,70	5	075490202
L	19,70	5	075490203
XL	19,70	5	075490204
XXL	19,70	5	075490205
XXXL	19,70	5	075490206

7549G

T-shirt de trabalho, 100% algodão, 150g/m²,
cinzento



	€		
XS	19,70	5	075490300
S	19,70	5	075490301
M	19,70	5	075490302
L	19,70	5	075490303
XL	19,70	5	075490304
XXL	19,70	5	075490305
XXXL	19,70	5	075490306

7549NE

t-shirt de trabalho, 100% algodão, 150 g/m², preto



	€		
XS	19,70	5	075490700
S	19,70	5	075490701
M	19,70	5	075490702
L	19,70	5	075490703
XL	19,70	5	075490704
XXL	19,70	5	075490705
XXXL	19,70	5	075490706

7549N

T-shirt de trabalho, 100% algodão, 150g/m², preto



	€		
XS	19,70	5	075490400
S	19,70	5	075490401
M	19,70	5	075490402
L	19,70	5	075490403
XL	19,70	5	075490404
XXL	19,70	5	075490405
XXXL	19,70	5	075490406

7549R

t-shirt de trabalho, 100% algodão, 150 g/m², vermelho



	€		
XS	19,70	5	075490600
S	19,70	5	075490601
M	19,70	5	075490602
L	19,70	5	075490603
XL	19,70	5	075490604
XXL	19,70	5	075490605
XXXL	19,70	5	075490606

7550G

t-shirt técnica, em poliéster, 120 g/m², com tecnologia 37.5°, cinzento com detalhes refletivos, em preto e laranja



	€		
XS	42,00	1	075500400
S	42,00	1	075500401
M	42,00	1	075500402
L	42,00	1	075500403
XL	42,00	1	075500404
XXL	42,00	1	075500405
XXXL	42,00	1	075500406

7550N

t-shirt técnica, em poliéster, 120 g/m², com tecnologia 37.5°, preto com detalhes refletivos, em preto e laranja



	€		
XS	42,00	1	075500500
S	42,00	1	075500501
M	42,00	1	075500502
L	42,00	1	075500503
XL	42,00	1	075500504
XXL	42,00	1	075500505
XXXL	42,00	1	075500506

7557BL

polo com 3 botões, manga comprida, 100% algodão, 200 g/m², azul



	€		
XS	35,50	1	075570200
S	35,50	1	075570201
M	35,50	1	075570202
L	35,50	1	075570203
XL	35,50	1	075570204
XXL	35,50	1	075570205
XXXL	35,50	1	075570206

RAIN

7970

calças, impermeáveis, em tricô PVC, azul
ATÉ RUTURA DE STOCK

CE



EN 343

	€		
XS	45,50	1	079700000
S	45,50	1	079700001
M	45,50	1	079700002
L	45,50	1	079700003
XL	45,50	1	079700004
XXL	45,50	1	079700005
XXXL	45,50	1	079700006



7971L

calças impermeáveis, em poliéster revestido a PVC, com costuras termoseladas, azul
Com cintura elástica e bainha ajustável com mola

CE



EN 343

	€		
XS	25,50	1	079710100
S	25,50	1	079710101
M	25,50	1	079710102
L	25,50	1	079710103
XL	25,50	1	079710104
XXL	25,50	1	079710105
XXXL	25,50	1	079710106

7979

casaco, impermeável, em tricô PVC, azul
ATÉ RUTURA DE STOCK

CE



EN 343

	€		
S	74,50	1	079790001
M	74,50	1	079790002
L	74,50	1	079790003
XL	74,50	1	079790004
XXL	74,50	1	079790005
XXXL	74,50	1	079790006

UNDERWEAR

7978L

blusão impermeável, em poliéster revestido a PVC, com capuz fixo e costuras termoseladas, azul
Com molas para converter em comprimento 3/4

CE



EN 343

	€		
XS	35,00	1	079780100
S	35,00	1	079780101
M	35,00	1	079780102
L	35,00	1	079780103
XL	35,00	1	079780104
XXL	35,00	1	079780105
XXXL	35,00	1	079780106

7996N

conjunto roupa interior técnica - camisola interior, manga comprida + calças interiores, 92% poliéster, 8% elastano, 160 g/m², preto



	€		
XS-S	42,50	1	079960000
M-L	42,50	1	079960002
XL-XXL	42,50	1	079960004

Beta

ACCESSORIES

7800G

par de joelheiras



7800G € 15,30 1 078000500

7980L

gorro com luz LED recarregável e barra 100% acrílico
luz LED com 3 configurações de luminosidade, até 60 lúmenes
tamanho único
preto

- Recarregável através de entrada USB
- Luminosidade: até 60 lúmenes
- Tempo de carga: 80 minutos
- Autonomia: 85 ÷ 290 minutos



7980L € 14,60 10 079800200

7980NC

gorro polar, 100% poliéster, reversível (dupla-face), preto camuflagem

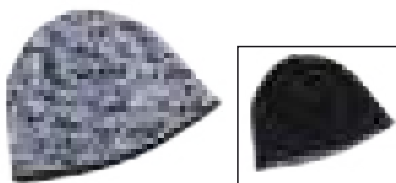

7980NC € 13,40 10 079800112

7980RN

chapéu impermeável, 100% acrílico, forrado com 3M Thinsulate™, tamanho único
preto



7980RN € 12,60 10 079800120

7981N

gorro impermeável, 100% nylon com revestimento PU, com tratamento hidrorrepelente



L = Ø 58 cm € 21,90 1 079810158
XL = Ø 60 cm € 21,90 1 079810160

7982N

boné, 100% poliéster, presilha de ajuste preto



7982N € 10,30 10 079820000

7984EG

cinto de trabalho em tecido elástico, com gancho de metal zincado acetinado, tamanho único, 120 cm, pode ser encurtado, largura 37 mm, cinza



7984EG € 26,00 1 079840520

7984G

cinto de trabalho, 100% TPE, com fivela metálica cromada, tamanho único; comprimento: 125 cm com possibilidade de encurtar; largura: 35 mm, preto



7984G € 17,80 1 079840525

7985N

gola em microfibra com cordão de ajuste, também pode ser utilizada como gorro, preto com detalhes refletivos em cinza



7985N € 12,60 10 079850000



7104 90

postes de plástico com base de enchimento



7104 90 H mm € 29,50 4 071040004

7105 6

corrente de barreira em plástico



7105 6 Ø mm L m € 71,00 1 071050006

7109A

sinais de alerta em alumínio



7109A 1 H mm € 12,40 1 071090001
7109A 2 140 12,40 1 071090002
7109A 3 140 12,40 1 071090003
7109A 4 140 12,40 1 071090004

7109D

sinais de proibição



7109D 1 H mm € 12,40 1 071090051
7109D 2 115 12,40 1 071090052
7109D 3 115 12,40 1 071090053

7061TC

óculos de segurança com lentes transparentes em policarbonato



EN166:2001
EN170
2C-1.2 1F

7061TC € 9,90 1 070610001

7076BC

óculos de segurança com lentes transparentes em policarbonato



EN166:2001
EN172
5-1.7 1F

7076BC € 22,50 1 070760009

7076BD

óculos de segurança com lentes transparentes em policarbonato



EN166:2001
EN172
5-3.1 1F

7076BD € 22,50 1 070760019

7076BP

óculos de segurança com lentes transparentes em policarbonato



EN ISO 12312-1:2013+A1:2015
EN 1836
3P

7076BP € 35,50 1 070760029

7076BU

óculos de segurança com lentes cor de laranja em policarbonato



EN ISO 12311:2013
UV 500

7076BU € 18,50 1 070760039

7093BC

óculos de segurança com lentes transparentes em policarbonato



EN166:2001
EN170
2C-1.2 1F

7093BC € 33,50 1 070930009

7093BD

óculos de segurança com lentes transparentes em policarbonato



EN166:2001
EN172
5-3.1 1F

7093BD € 33,50 1 070930019



C62M/WW

manequim, tamanho realista, base em metal



185 cm

C62M/WW € 260,00 1 062000362

C64

expositor de parede para vestuário e calçado, vazio



2400 mm

L	€	1	064000021
1 m	1.460,00	1	064000021
2 m	2.640,00	1	064000022
3 m	3.820,00	1	064000023
4 m	5.000,00	1	064000024

C64G

expositor tipo "gondola" para vestuário e calçado, vazio

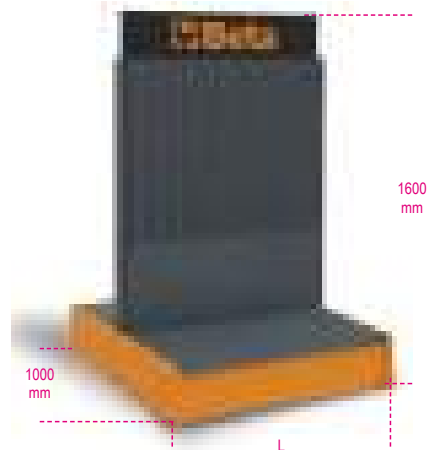

L	€	Unidade	Código
1 m	1.790,00	1	064000051
2 m	3.250,00	1	064000052

C64CW

vestiário



C64CW	€	Unidade	Código
	620,00	1	064000610

6200AP/S10

conjunto de 10 cabides



6200AP/S10	€	Unidade	Código
	44,50	1	062000331

6800BA



6800BA	€	Unidade	Código
	130,00	1	068000130

6800RS



6800RS	€	Unidade	Código
	112,00	1	068000135

6888GS

gancho para calçado para expositor C64



6888GS	€	Unidade	Código
	28,00	2	068880122

170x120 mm

6888GW

gancho para expositor C64



6888GW	€	Unidade	Código
	7,80	2	068880121

400 mm

9562TB

tapete para experimentar sapatos, com parte de trás antiderrapante em borracha



9562TB	L mm	H mm	€	Unidade	Código
	800	600	49,50	1	095620500

9565S

Bidão em folha de aço, com assento em imitação de cabedal amovível



9565S	H cm	Ø cm	€	Unidade	Código
	60	38	219,00	1	095650300



Beta



Robur

Desde 1930 que a Robur produz uma linha de acessórios para cabos aliando-se aos mais altos padrões de qualidade reconhecidos nas ferramentas Beta, tornando-se num complemento produtivo desta.

A experiência, organização e tecnologia são os requisitos chave do contínuo desenvolvimento que a exigência do mercado determina.

Desde 1984 que a Robur foi sediada em Sulmona numa moderna unidade de produção.



**Embalagens especiais
com blister**

CARGA MÁXIMA DE UTILIZAÇÃO

WLL: limite de carga de trabalho
(para acessórios de elevação)

WFL: força de trabalho limite
(para outros acessórios
que não de elevação)

BF: força máxima alcançada durante
o teste de tracção estático

LC: carga de trabalho

Novidade 2024

8134

ímã de elevação

CE



EN13155

Características técnicas:

- Fator de segurança: 3
- Etiqueta de identificação

Certificados disponíveis:

- Certificado do Fabricante
- Declaração de Conformidade com Diretiva de Máquinas 2006/42/EC
- Relatório de Teste UNI EN10204 tipo 2.2
- Manual de funcionamento e manutenção

Preço unitário

Dimensão

Quantidade
por caixa

WLL kg	A mm	B mm	C mm	€	Quantidade por caixa	Código
100	70	64	92	480,00	1	081340010
300	96	88	165	845,00	1	081340030
600	120	118	230	1.570,00	1	081340060
1000	168	168	264	2.590,00	1	081340100

8105

tensores com 2 olhais em aço ligeiro galvanizado a quente

CE



CARACTERÍSTICAS TÉCNICAS

- fator de segurança: 5
- tratamento térmico, corpo: normalizador
- tratamento térmico, olhais: endurecido e temperado

TESTES LABORATORIAIS

- análise química
- ensaio de tracção

CERTIFICADOS DISPONÍVEIS

- Especificações técnicas
- Relatório de ensaio UNI EN10204 tipo 2.2

ØxE "	≈ mm	WLL kg	€	📦	🚚
3/8x6	M10x150	540	15,20	5	081050010
1/2x6	M12x150	1000	24,90	5	081050011
1/2x9	M12x230	1000	32,00	5	081050012
5/8x6	M16x150	1590	38,50	2	081050014
5/8x9	M16x230	1590	47,50	2	081050016
5/8X12	M16X300	1590	57,00	2	081050015
3/4x6	M20x150	2360	61,00	2	081050017
3/4x9	M20x230	2360	71,00	2	081050020
3/4x12	M20x300	2360	85,00	2	081050018
3/4x18	M20x460	2360	112,00	2	081050021
7/8x12	M22x300	3270	120,00	1	081050022
1x6	M24x150	4540	128,00	1	081050024
1x12	M24x300	4540	183,00	1	081050025
1x18	M24x460	4540	215,00	1	081050026
1.1/4x12	M33x300	6900	312,00	1	081050031
1.1/4x18	M33x460	6900	322,00	1	081050032
1.1/4x24	M33x610	6900	436,00	1	081050033
1.1/2x12	M39x300	9710	386,00	1	081050034
1.1/2x18	M39x460	9710	469,00	1	081050035
1.3/4x18	M45x460	12700	710,00	1	081050036

Embalagens especiais com blister



ØxE "	📦	€	📦	🚚
3/8x6	1	16,50	1	081059010
1/2x9	1	33,50	1	081059012

Robur

8109

tensores com 2 forquilhas em aço ligeiro galvanizado a quente

CE

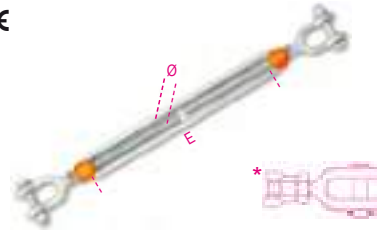

CARACTERÍSTICAS TÉCNICAS

- fator de segurança: 5
- tratamento térmico, corpo: normalizador
- tratamento térmico, forquilhas: endurecido e temperado

TESTES LABORATORIAIS

- análise química
- ensaio de tracção

CERTIFICADOS DISPONÍVEIS

- Especificações técnicas
- Relatório de ensaio UNI EN10204 tipo 2.2

ØxE "	≈ mm	WLL kg	€	📦	🚚
3/8x6	M10x150	540	19,70	5	081090010
1/2x6	M12x150	1000	32,50	5	081090011
1/2x9	M12x230	1000	39,00	5	081090012
1/2x12	M12x300	1000	49,50	5	081090013
5/8x6	M16x150	1590	59,50	2	081090015
5/8x9	M16x230	1590	70,50	2	081090016
5/8X12	M16X300	1590	79,00	2	081090017
3/4x6	M20x150	2360	83,00	2	081090018
3/4x9	M20x230	2360	96,50	2	081090020
3/4x12	M20x300	2360	108,00	2	081090019
3/4x18	M20x460	2360	128,00	2	081090021
7/8x12	M22x300	3270	161,00	1	081090022
7/8x18	M22x460	3270	195,00	1	081090023
1x6	M24x150	4540	160,00	1	081090024
1x12	M24x300	4540	229,00	1	081090025
1x18	M24x460	4540	264,00	1	081090026
* 1.1/4x12	M33x300	6900	371,00	1	081090031
* 1.1/4x18	M33x460	6900	416,00	1	081090032
* 1.1/4x24	M33x610	6900	580,00	1	081090033
* 1.1/2X12	M39x300	9710	540,00	1	081090034
* 1.1/2x18	M39x460	9710	620,00	1	081090038
* 1.1/2x24	M39x610	9710	740,00	1	081090039
* 1.3/4X18	M45x460	12700	900,00	1	081090036

Embalagens especiais com blister



ØxE "	📦	€	📦	🚚
3/8x6	1	21,00	1	081099010
1/2x9	1	40,00	1	081099012

8110

esticador de olhal e manilha, aço de elevada resistência, galvanizado a quente

CE

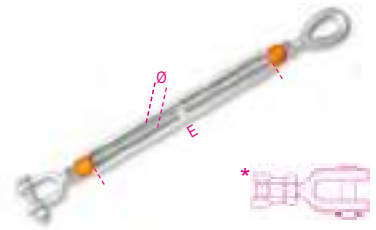

CARACTERÍSTICAS TÉCNICAS

- fator de segurança: 5
- tratamento estrutura (corpo): normalizador
- tratamento olhal: reforçado e temperado
- código identificação

TESTES LABORATORIAIS

- análise química
- ensaio de tensão

CERTIFICADOS DISPONÍVEIS

- Especificações técnicas
- Relatório de teste UNI EN10204 tipo 2.2
- Certificado de inspeção UNI EN10204 tipo 3.1
- Declaração de Conformidade CE

ØxE "	≈ mm	WLL kg	€	📦	🚚
3/8x6	M10X150	540	17,90	5	081100004
1/2x6	M12x150	1000	28,50	5	081100006
1/2x9	M12x230	1000	35,00	5	081100010
5/8x6	M16x150	1590	49,50	2	081100014
5/8x9	M16X230	1590	58,00	2	081100015
5/8x12	M16x300	1590	67,50	2	081100016
3/4x6	M20x150	2360	73,00	2	081100019
3/4x9	M20x230	2360	84,00	2	081100020
3/4x12	M20x300	2360	96,00	2	081100021
7/8X12	M22x300	3270	140,00	1	081100022
1x6	M24x150	4540	144,00	1	081100027
1x12	M24x300	4540	206,00	1	081100029
*1.1/4x12	M33x300	6900	343,00	1	081100034
*1.1/4x18	M33X460	6900	407,00	1	081100035
*1.1/4x24	M33X610	6900	505,00	1	081100036
*1.1/2x12	M39x300	9710	480,00	1	081100038
*1.1/2x18	M39x460	9710	545,00	1	081100039
*1.3/4x18	M45x460	12700	830,00	1	081100044

Gancho com pino de segurança

Outros tamanhos disponíveis a pedido

Robur

Robur

TENSORES

O design original dos tensores **Robur** é extremamente popular entre os designers e engenheiros estruturais italianos, baseado em tolerâncias dimensionais precisas, valores de resistência superiores aos modelos DIN 1480, bem como rastreabilidade garantida tanto pelo fabricante como pelo código de identificação no corpo. A galvanização eletrolítica de qualidade, com depósitos uniformes isentos de crómio hexavalente, resulta numa boa resistência às intempéries e aparência cuidada dos elementos estruturais expostos.



8005Z

tensores de dois olhais, zincados

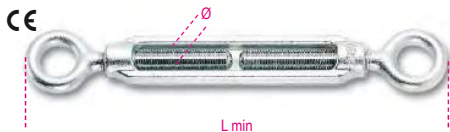

CARACTERÍSTICAS TÉCNICAS

- factor de segurança: 4
- TESTES LABORATORIAIS
- análise química
- ensaio de tracção
- CERTIFICADOS DISPONÍVEIS
- Especificações técnicas
- Relatório de ensaio UNI EN10204 tipo 2.2
- Declaração de Conformidade CE

Ø mm	≈	L min mm	WFL kg	€	📦	🚚
M5	3/16	118	115	2,52	400	080050105
M6	1/4	130	160	2,78	300	080050106
M8	5/16	158	300	4,25	200	080050108
M10	3/8	192	470	6,10	100	080050110
M11	7/16	206	580	8,00	80	080050111
M12	1/2	226	690	9,40	60	080050112
M14	9/16	256	940	12,90	15	080050114
M16	5/8	290	1290	19,40	10	080050116
M18	11/16	358	1660	28,50	1	080050118
M20	3/4	358	2130	32,00	1	080050120
M22	7/8	400	2630	44,00	1	080050122
M24	1"	436	3060	55,50	1	080050124
M27	1 1/8	474	4000	80,50	1	080050125
M30	1 3/16	498	4860	97,50	1	080050130
M33	1 1/4	516	6040	113,00	1	080050126
M36	1 3/8	532	6500	141,00	1	080050136
M39	1 1/2	544	7900	166,00	1	080050139

confeção especial



Ø mm	≈	📦	€	🚚
M5	3/16	30	85,50	1 080050705
M6	1/4	30	94,00	1 080050706
M8	5/16	20	96,00	1 080050708
M10	3/8	15	103,00	1 080050710
M11	7/16	15	135,00	1 080050711
M12	1/2	15	158,00	1 080050712

Embalagens especiais com blister

Ø mm	📦	€	🚚
M5	2	6,00	1 080059305
M6	2	6,80	1 080059306
M8	1	5,70	1 080059108
M10	1	7,50	1 080059110
M11	1	9,70	1 080059111
M12	1	10,80	1 080059112
M14	1	13,90	1 080059114
M16	1	20,70	1 080059116

8005TZ

tensor de dois olhais, zincado



CARACTERÍSTICAS TÉCNICAS

- factor de segurança: 4
- TESTES LABORATORIAIS
- análise química
- ensaio de tracção
- CERTIFICADOS DISPONÍVEIS
- Especificações técnicas
- Relatório de ensaio UNI EN10204 tipo 2.2
- Declaração de Conformidade CE

Ø mm	≈	WFL kg	€	📦	🚚
M12	1/2	690	12,80	15	080050512
M16	5/8	1290	21,90	1	080050516
M20	3/4	2130	31,50	1	080050520
M24	1"	3060	57,50	1	080050524
M27	1 1/8	4000	78,00	1	080050527
M30	1 3/16	4860	90,00	1	080050530
M36	1 3/8	6500	144,00	1	080050536

Embalagens especiais com blister

Ø mm	📦	€	🚚
M12	1	15,20	1 080059512

Robur

Robur

8006Z

tensores de olhal e gancho, zincados

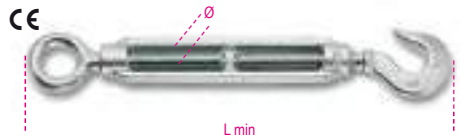

CARACTERÍSTICAS TÉCNICAS

- factor de segurança: 4
- TESTES LABORATORIAIS
- análise química
- ensaio de tracção
- CERTIFICADOS DISPONÍVEIS
- Especificações técnicas
- Relatório de ensaio UNI EN10204 tipo 2.2
- Declaração de Conformidade CE

Ø mm	≈	L min mm	WFL kg	€	📦	🚚
M5	3/16	121	25	2,67	400	080060105
M6	1/4	132	45	2,94	250	080060106
M8	5/16	170	95	4,45	180	080060108
M10	3/8	204	140	6,70	100	080060110
M11	7/16	221	165	8,70	15	080060111
M12	1/2	244	300	10,30	15	080060112
M14	9/16	284	420	14,70	10	080060114
M16	5/8	322	570	21,80	1	080060116
M18	11/16	373	700	31,50	1	080060118
M20	3/4	391	900	38,00	1	080060120
M22	7/8	433	1100	50,50	1	080060122
M24	1"	470	1300	68,00	1	080060124
M27	1 1/8	503	2300	92,50	1	080060127

confeção especial



Ø mm	≈	📦	€	🚚
M5	3/16	30	90,50	1 080060705
M6	1/4	30	99,50	1 080060706
M8	5/16	20	101,00	1 080060708
M10	3/8	15	112,00	1 080060710

Embalagens especiais com blister

Ø mm	📦	€	🚚
M5	2	6,80	1 080069305
M6	2	7,60	1 080069306
M8	1	5,80	1 080069108
M10	1	7,90	1 080069110
M11	1	10,10	1 080069111
M12	1	11,40	1 080069112
M14	1	16,30	1 080069114

8007Z

tensores de dois ganchos, zincados

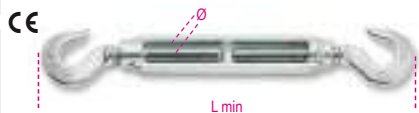

CARACTERÍSTICAS TÉCNICAS

• factor de segurança: 4

TESTES LABORATORIAIS

- análise química
- ensaio de tracção

CERTIFICADOS DISPONÍVEIS

- Especificações técnicas
- Relatório de ensaio UNI EN10204 tipo 2.2
- Declaração de Conformidade CE

Ø mm	≈	L min mm	WFL kg	€		
M5	3/16	124	25	2,83	30	080070105
M6	1/4	134	45	3,10	30	080070106
M8	5/16	181	95	4,70	20	080070108
M10	3/8	211	140	7,20	15	080070110
M11	7/16	231	165	9,40	15	080070111
M12	1/2	262	300	11,30	15	080070112
M14	9/16	312	420	16,70	1	080070114
M16	5/8	354	570	24,10	1	080070116
M18	11/16	388	700	34,00	1	080070118
M20	3/4	424	900	44,00	1	080070120
M22	7/8	466	1100	57,00	1	080070122
M24	1"	504	1300	80,50	1	080070124
M27	1 1/8	532	2300	105,00	1	080070127

Embalagens especiais com blister

Ø mm	≈	€		
M5	2	7,10	1	080079305
M6	2	7,60	1	080079306
M8	1	5,70	1	080079108
M10	1	7,70	1	080079110
M11	1	10,40	1	080079111
M12	1	12,30	1	080079112

8008N

tensores de dois troncos, negros

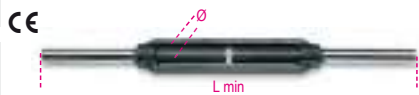

CARACTERÍSTICAS TÉCNICAS

• factor de segurança: 4

TESTES LABORATORIAIS

- análise química
- ensaio de tracção

CERTIFICADOS DISPONÍVEIS

- Especificações técnicas
- Relatório de ensaio UNI EN10204 tipo 2.2
- Declaração de Conformidade CE

Ø mm	≈	L min mm	WFL kg	€		
M5	3/16	160	115	2,46	30	080080205
M6	1/4	180	160	2,73	30	080080206
M8	5/16	210	300	3,80	20	080080208
M10	3/8	250	470	5,10	15	080080210
M12	1/2	280	690	7,60	15	080080212
M14	9/16	340	940	10,70	5	080080214
M16	5/8	380	1290	14,30	5	080080216
M18	11/16	410	1660	21,30	3	080080218
M20	3/4	440	2130	25,00	3	080080220
M22	7/8	480	2630	31,50	2	080080222
M24	1"	520	3060	41,00	2	080080224
M27	1 1/8	560	4000	64,50	1	080080227
M30	1 3/8	560	4860	80,50	1	080080230
M33	1 1/4	600	6040	86,50	1	080080233
M36	1 3/8	600	6500	112,00	1	080080236
M39	1 1/2	600	7900	128,00	1	080080239

Embalagens especiais com blister



Ø mm	≈	€		
M5	2	6,90	1	080089305
M6	2	7,00	1	080089306
M8	1	5,10	1	080089208
M10	1	6,80	1	080089210
M12	1	8,60	1	080089212
M14	1	11,90	1	080089214

8008TZN

Tensores de tubos DIN 1478, terminais coloridos, corpo galvanizado DIN 1478



CARACTERÍSTICAS TÉCNICAS

• factor de segurança: 4

TESTES LABORATORIAIS

- análise química
- ensaio de tracção

CERTIFICADOS DISPONÍVEIS

- Especificações técnicas
- Relatório de ensaio UNI EN10204 tipo 2.2
- Declaração de Conformidade CE

Ø mm	≈	WFL kg	€		
M12	1/2	690	10,50	10	080080512
M16	5/8	1290	17,30	1	080080516
M20	3/4	2130	25,50	1	080080520
M24	1	3060	44,50	1	080080524
M27	1 1/8	4000	65,50	1	080080527
M30	1 3/8	4860	77,50	1	080080530
M36	1 3/8	6500	122,00	1	080080536

8009Z

tensores de duas forquilhas, zincados



CARACTERÍSTICAS TÉCNICAS

• factor de segurança: 4

TESTES LABORATORIAIS

- análise química
- ensaio de tracção

CERTIFICADOS DISPONÍVEIS

- Especificações técnicas
- Relatório de ensaio UNI EN10204 tipo 2.2
- Declaração de Conformidade CE

Ø mm	≈	L min mm	WFL kg	€		
M8	5/16	192	300	13,90	15	080090008
M10	3/8	234	470	16,60	15	080090010
M12	1/2	274	690	22,30	15	080090012
M14	9/16	342	940	31,00	1	080090014
M16	5/8	372	1290	36,50	1	080090016
M18	11/16	406	1660	53,50	1	080090018
M20	3/4	406	2130	56,50	1	080090020
M22	7/8	466	2630	78,00	1	080090022
M24	1"	486	3060	91,00	1	080090024
M27	1 1/8	510	4000	143,00	1	080090027
M30	1 3/8	566	4860	183,00	1	080090030

packs especiais



Ø mm	≈	€		
M8	5/16	5	78,00	1 080090708
M10	3/8	5	93,50	1 080090710
M12	1/2	5	125,00	1 080090712

Embalagens especiais com blister



Ø mm	≈	€		
M8	1	15,80	1	080099008
M10	1	18,00	1	080099010
M12	1	24,30	1	080099012

8009TZ

tensores de duas forquilhas, corpo tubular, DIN 1478 galvanizados



CARACTERÍSTICAS TÉCNICAS

• coeficiente de segurança: 4

TESTES LABORATORIAIS

- análise química
- teste elasticidade

CERTIFICADOS DISPONÍVEIS

- Especificações do Produto
- Relatório de Teste UNI EN10204 tipo 2.2
- Declaração de Conformidade CE

Ø mm	≈	WFL kg	€		
M12	1/2	690	25,00	10	080090512
M16	5/8	1290	39,00	1	080090516
M20	3/4	2130	55,50	1	080090520
M24	1	3060	92,50	1	080090524
M27	1 1/8	4000	140,00	1	080090527
M30	1 3/8	4860	176,00	1	080090530

Embalagens especiais com blister



Ø mm	≈	€		
M12	1	24,90	1	080099512



8010Z

tensores de olhal e forquilha, zincados



CARACTERÍSTICAS TÉCNICAS

- fator de segurança: 4
- TESTES LABORATORIAIS
- análise química
- ensaio de tracção
- CERTIFICADOS DISPONÍVEIS
- Especificações técnicas
- Relatório de ensaio UNI EN10204 tipo 2.2
- Declaração de Conformidade CE

Ø mm	≈	L min mm	WFL kg	€	📦	📄
M8	5/16	175	300	9,10	20	080100008
M10	3/8	215	470	11,40	15	080100010
M12	1/2	250	690	15,90	10	080100012
M14	9/16	299	940	21,90	10	080100014
M16	5/8	331	1290	28,00	1	080100016
M18	11/16	382	1660	40,50	1	080100018
M20	3/4	382	2130	44,00	1	080100020
M22	7/8	433	2630	61,00	1	080100022
M24	1"	461	3060	73,00	1	080100024
M27	1 1/8	492	4000	112,00	1	080100027
M30	1 3/16	529	4860	141,00	1	080100030

Embalagens especiais com blister



Ø mm	📦	€	📄
M8	1	10,20	1 080109008
M10	1	12,60	1 080109010
M12	1	17,20	1 080109012
M14	1	24,30	1 080109014

8010TZ

Tensores de olhal e forquilha, zincados DIN 1478



CARACTERÍSTICAS TÉCNICAS

- fator de segurança: 4
- TESTES LABORATORIAIS
- análise química
- ensaio de tracção
- CERTIFICADOS DISPONÍVEIS
- Especificações técnicas
- Relatório de ensaio UNI EN10204 tipo 2.2
- Declaração de Conformidade CE

Ø mm	≈	WFL kg	€	📦	📄
M12	1/2	690	18,60	10	080100612
M16	5/8	1290	30,50	1	080100616
M20	3/4	2130	43,50	1	080100620
M24	1	3060	75,00	1	080100624
M27	1.1/8	4000	109,00	1	080100627
M30	1.3/16	4860	133,00	1	080100630

8011Z

tensor com gancho e forquilha, galvanizado



CARACTERÍSTICAS TÉCNICAS

- fator de segurança: 4
- TESTES LABORATORIAIS
- análise química
- ensaio de tração
- CERTIFICADOS DISPONÍVEIS
- Especificações técnicas
- Relatório de ensaio UNI EN10204 tipo 2.2
- Declaração de Conformidade CE

Ø mm	≈	L min mm	WFL kg	€	📦	📄
M12	1/2	270	300	14,30	1	080110112
M16	5/8	360	570	29,50	1	080110116
M20	3/4	420	900	49,00	1	080110120
M24	1"	490	1300	82,00	1	080110124
M27	1 1/8	500	2300	114,00	1	080110127

8011TZ

tensor com gancho e forquilha, DIN 1478, galvanizado



CARACTERÍSTICAS TÉCNICAS

- fator de segurança: 4
- TESTES LABORATORIAIS
- análise química
- ensaio de tração
- CERTIFICADOS DISPONÍVEIS
- Especificações técnicas
- Relatório de ensaio UNI EN10204 tipo 2.2
- Declaração de Conformidade CE

Ø mm	≈	L min mm	WFL kg	€	📦	📄
M12	1/2	260	300	16,40	1	080110612
M16	5/8	350	570	30,00	1	080110616
M20	3/4	400	900	45,50	1	080110620
M24	1"	490	1300	79,00	1	080110624
M27	1 1/8	500	2300	105,00	1	080110627

8001Z

corpos para tensores, zincados



CARACTERÍSTICAS TÉCNICAS

- fator de segurança: 4
- código de identificação
- TESTES LABORATORIAIS
- análise química
- ensaio de tracção
- CERTIFICADOS DISPONÍVEIS
- Especificações técnicas
- Relatório de ensaio UNI EN10204 tipo 2.2
- Declaração de Conformidade CE

Ø mm	≈	L mm	WFL kg	€	📦	📄
M5	3/16	80	115	1,51	100	080010105
M6	1/4	80	160	1,58	100	080010106
M8	5/16	105	300	2,48	25	080010108
M10	3/8	125	470	3,20	20	080010110
M11	7/16	135	580	3,95	15	080010111
M12	1/2	140	690	4,25	20	080010112
M14	9/16	170	940	6,00	15	080010114
M16	5/8	190	1290	8,20	15	080010116
M18	11/16	205	1660	13,00	10	080010118

Ø mm	≈	L mm	WFL kg	€	📦	📄
M20	3/4	220	2130	15,00	10	080010120
M22	7/8	240	2630	18,90	8	080010122
M24	1"	260	3060	23,10	5	080010124
M27	1 1/8	270	4000	36,50	1	080010127
M30	1 3/16	280	4860	45,50	1	080010130
M33	1 1/4	290	6040	50,50	1	080010133
M36	1 3/8	300	6500	65,00	1	080010136
M39	1 1/2	300	7900	77,50	1	080010139

Embalagens especiais com blister



Ø mm	📦	€	📄
M5	2	4,55	1 080019305
M6	2	5,00	1 080019306
M8	1	3,95	1 080019108
M10	1	4,60	1 080019110
M11	1	5,60	1 080019111
M12	1	5,80	1 080019112
M14	1	7,70	1 080019114
M16	1	9,80	1 080019116
M18	1	14,50	1 080019118
M20	1	16,30	1 080019120
M22	1	20,60	1 080019122
M24	1	24,70	1 080019124

8001TZ

corpo para tensores, zincado



DIN 1478

CARACTERÍSTICAS TÉCNICAS

- fator de segurança: 4
- código de identificação
- TESTES LABORATORIAIS
- análise química
- ensaio de tracção
- CERTIFICADOS DISPONÍVEIS
- Especificações técnicas
- Relatório de ensaio UNI EN10204 tipo 2.2
- Declaração de Conformidade CE

Ø mm	≈	L mm	WFL kg	€	📦	📄
M12	1/2	125	690	7,10	10	080010512
M16	5/8	170	1290	10,80	5	080010516
M20	3/4	200	2130	14,20	5	080010520
M24	1	255	3060	24,90	3	080010524
M27	1.1/8	255	4000	33,50	1	080010527
M30	1.3/16	255	4860	38,00	1	080010530
M36	1.3/8	295	6500	68,50	1	080010536
M42	1.5/8	330	9700	96,50	1	080010542

Embalagens especiais com blister



Ø mm	📦	€	📄
M12	1	8,50	1 080019512
M16	1	11,90	1 080019516
M20	1	15,50	1 080019520
M24	1	26,00	1 080019524

8002ZD

olhais para tensores, de rosca direita, zincados

disponível com rosca esquerda, a pedido



CARACTERÍSTICAS TÉCNICAS

- factor de segurança: 4
 - TESTES LABORATORIAIS
 - análise química
 - ensaio de tracção
- CERTIFICADOS DISPONÍVEIS**
- Especificações técnicas
 - Relatório de ensaio UNI EN10204 tipo 2.2

Ø mm	≈ "	E mm	WFL kg	€		
M5	3/16	37	115	0,52	200	080020105
M6	1/4	40	160	0,64	150	080020106
M8	5/16	52	300	0,94	100	080020108
M10	3/8	60	470	1,51	100	080020110
M11	7/16	65	580	2,14	1	080020111
M12	1/2	72	690	2,67	50	080020112
M14	9/16	85	940	3,30	1	080020114
M16	5/8	95	1290	5,60	1	080020116
M18	11/16	103	1660	8,20	1	080020118
M20	3/4	110	2130	9,20	1	080020120
M22	7/8	120	2630	13,40	1	080020122
M24	1"	130	3060	17,00	1	080020124
M27	1 1/8	135	4000	23,40	1	080020127
M30	1 3/16	140	4860	27,50	1	080020130
M33	1 1/4	148	6040	33,00	1	080020133
M36	1 3/8	150	6500	40,00	1	080020198
M39	1 1/2	150	7900	47,00	1	080020199

Ø mm	≈ "	E mm	WFL kg	€		
M5	3/16	37	115	0,52	1	080020305
M6	1/4	40	160	0,64	1	080020306
M8	5/16	52	300	0,94	1	080020308
M10	3/8	60	470	1,51	1	080020310
M11	7/16	65	580	2,14	1	080020311
M12	1/2	72	690	2,67	1	080020312
M14	9/16	85	940	3,30	1	080020314
M16	5/8	95	1290	5,60	1	080020316
M18	11/16	103	1660	8,20	1	080020318
M20	3/4	110	2130	9,20	1	080020320
M22	7/8	120	2630	13,40	1	080020322
M24	1"	130	3060	17,00	1	080020324
M27	1 1/8	135	4000	23,40	1	080020327
M30	1 3/16	140	4860	27,50	1	080020330
M33	1 1/4	148	6040	33,00	1	080020333
M36	1 3/8	150	6500	40,00	1	080020398
M39	1 1/2	150	7900	47,00	1	080020399

Robur

8003ZD

ganchos para tensores, de rosca direita, zincados

disponível com rosca esquerda, a pedido



CARACTERÍSTICAS TÉCNICAS

- factor de segurança: 4
 - TESTES LABORATORIAIS
 - análise química
 - ensaio de tracção
- CERTIFICADOS DISPONÍVEIS**
- Especificações técnicas
 - Relatório de ensaio UNI EN10204 tipo 2.2

Ø mm	≈ "	E mm	WFL kg	€		
M5	3/16	40	25	0,69	150	080030105
M6	1/4	40	45	0,78	120	080030106
M8	5/16	52	95	1,16	100	080030108
M10	3/8	60	140	2,07	70	080030110
M11	7/16	65	165	2,83	1	080030111
M12	1/2	70	300	3,60	30	080030112
M14	9/16	85	420	5,60	1	080030114
M16	5/8	95	570	8,30	1	080030116
M18	11/16	103	700	11,20	1	080030118
M20	3/4	110	900	15,20	1	080030120
M22	7/8	120	1100	19,70	1	080030122
M24	1"	130	1300	30,00	1	080030124
M27	1 1/8	135	2300	35,50	1	080030127

Ø mm	≈ "	WFL kg	E mm	€		
M5	3/16	40	25	0,69	1	080030305
M6	1/4	40	45	0,78	1	080030306
M8	5/16	52	95	1,16	1	080030308
M10	3/8	60	140	2,07	1	080030310
M11	7/16	65	165	2,83	1	080030311
M12	1/2	70	300	3,60	1	080030312
M14	9/16	85	420	5,60	1	080030314
M16	5/8	95	570	8,30	1	080030316
M18	11/16	103	700	11,20	1	080030318
M20	3/4	110	900	15,20	1	080030320
M22	7/8	120	1100	19,70	1	080030322
M24	1"	130	1300	30,00	1	080030324
M27	1 1/8	135	2300	35,50	1	080030327

8004ND

tensores de tronco rosca direita - negros

Rosca esquerda a pedido



CARACTERÍSTICAS TÉCNICAS

- factor de segurança: 4
 - TESTES LABORATORIAIS
 - análise química
 - ensaio de tracção
- CERTIFICADOS DISPONÍVEIS**
- Especificações técnicas
 - Relatório de ensaio UNI EN10204 tipo 2.2

Ø mm	≈ "	E mm	WFL kg	€		
M5	3/16	40	115	0,54	1	080040005
M6	1/4	44	160	0,64	1	080040006
M8	5/16	53	300	0,75	1	080040008
M10	3/8	63	470	1,11	1	080040010
M12	1/2	70	690	1,85	1	080040012
M14	9/16	85	940	2,55	1	080040014
M16	5/8	95	1290	3,50	1	080040016
M18	11/16	103	1660	4,75	1	080040018
M20	3/4	110	2130	6,00	1	080040020
M22	7/8	120	2630	7,50	1	080040022
M24	1"	130	3060	10,50	1	080040024
M27	1 1/8	135	4000	16,80	1	080040027
M30	1 3/16	140	4860	20,80	1	080040030
M33	1 1/4	150	6040	21,50	1	080040033
M36	1 3/8	150	6500	28,50	1	080040098
M39	1 1/2	150	7900	30,50	1	080040099

Ø mm	≈ "	E mm	WFL kg	€		
M5	3/16	40	115	0,54	1	080040105
M6	1/4	44	160	0,64	1	080040106
M8	5/16	53	300	0,75	1	080040108
M10	3/8	63	470	1,11	1	080040110
M12	1/2	70	690	1,85	1	080040112
M14	9/16	85	940	2,55	1	080040114
M16	5/8	95	1290	3,50	1	080040116
M18	11/16	103	1660	4,75	1	080040118
M20	3/4	110	2130	6,00	1	080040120
M22	7/8	120	2630	7,50	1	080040122
M24	1"	130	3060	10,50	1	080040124
M27	1 1/8	135	4000	16,80	1	080040127
M30	1 3/16	140	4860	20,80	1	080040130
M33	1 1/4	150	6040	21,50	1	080040133
M36	1 3/8	150	6500	28,50	1	080040198
M39	1 1/2	150	7900	30,50	1	080040199

Robur

8009FD

tensores de forquilha
rosca direita - zincados
Rosca esquerda a pedido

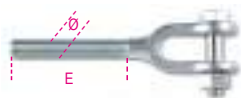

CARACTERÍSTICAS TÉCNICAS

- factor de segurança: 4
- TESTES LABORATORIAIS**
- análise química
- ensaio de tracção
- CERTIFICADOS DISPONÍVEIS**
- Especificações técnicas
- Relatório de ensaio UNI EN10204 tipo 2.2

Ø mm	≈ "	E mm	WFL kg	€		
M8	5/16	53	300	5,90	1	080090208
M10	3/8	63	470	7,00	1	080090210
M12	1/2	70	690	9,40	1	080090212
M14	9/16	85	940	13,00	1	080090214
M16	5/8	95	1290	14,70	1	080090216
M18	11/16	103	1660	20,80	1	080090218
M20	3/4	110	2130	21,50	1	080090220
M22	7/8	120	2630	30,50	1	080090222
M24	1"	130	3060	35,00	1	080090224
M27	1 1/8	135	4000	55,50	1	080090227
M30	1 3/16	140	4860	71,50	1	080090230

forquilhas para tensores direitos - zincadas

Ø mm	≈ "	WFL kg	G mm	€		
M8	5/16	53	300	5,90	1	080090408
M10	3/8	63	470	7,00	1	080090410
M12	1/2	70	690	9,40	1	080090412
M14	9/16	85	940	13,00	1	080090414
M16	5/8	95	1290	14,70	1	080090416
M18	11/16	103	1660	20,80	1	080090418
M20	3/4	110	2130	21,50	1	080090420
M22	7/8	120	2630	30,50	1	080090422
M24	1"	130	3060	35,00	1	080090424
M27	1 1/8	135	4000	55,50	1	080090427
M30	1 3/16	140	4860	71,50	1	080090430

8048

tirantes de olhal rosca direita, negras



UNI 6058

ØxL mm	WFL kg	F mm	E mm	€		
M8x50	430	6	39	3,65	20	080480108
M8x65	430	6	54	3,95	20	080480109
M10x80	690	8	66	6,20	10	080480110
M10x100	690	8	86	6,20	10	080480210
M10x130	690	8	116	7,00	10	080480111
M12x70	1020	10	53	6,40	8	080480212
M12x95	1020	10	78	6,60	8	080480112
M12x125	1020	10	108	8,00	8	080480113
M14x110	1420	12	91	9,00	6	080480114
M16x100	1980	14	79	7,50	6	080480115
M16x130	1980	14	109	7,70	6	080480116
M18x150	2390	16	126	17,40	2	080480118
M20x160	3100	18	134	21,50	2	080480120
M22x180	3890	18	152	33,50	1	080480122
M24x200	4460	20	168	38,50	1	080480124
M24x220	4460	20	188	41,00	1	080480125
M27x220	5900	22	185	50,00	1	080480127

packs especiais



Ø mm	C mm	E mm	WFL kg	€		
M5	6,0	60	47,00	1	083030705	
M6	8,0	50	42,50	1	083030706	
M8	10,0	30	41,50	1	083030708	
M10	12,5	25	58,50	1	083030710	
M12	16,0	10	39,00	1	083030712	

packs especiais

packs especiais

8302Z

parafuso com olhal de fixação
rosca direita, zincado



CARACTERÍSTICAS TÉCNICAS

- factor de segurança: 4
- CERTIFICADOS DISPONÍVEIS**
- Especificações técnicas
- Relatório de ensaio UNI EN10204 tipo 2.2

Ø mm	E mm	F mm	WFL kg	€		
M5	48	8	115	0,58	200	083020005
M6	55	10	160	0,71	150	083020006
M8	60	12	300	0,96	100	083020008
M10	73	14	470	1,64	100	083020010
M12	90	17	690	3,20	50	083020012

packs especiais



Ø mm	E mm	WFL kg	€		
M5	48	100	66,50	1	083020705
M6	55	75	60,50	1	083020706
M8	60	50	54,50	1	083020708
M10	73	50	93,00	1	083020710
M12	90	25	90,00	1	083020712

8303Z

gancho de fixação rosca direita, zincado



CARACTERÍSTICAS TÉCNICAS

- factor de segurança: 4
- CERTIFICADOS DISPONÍVEIS**
- Especificações técnicas
- Relatório de ensaio UNI EN10204 tipo 2.2

Ø mm	C mm	E mm	WFL kg	€		
M5	6,0	48	25	0,69	120	083030005
M6	8,0	55	45	0,75	100	083030006
M8	10,0	60	95	1,22	75	083030008
M10	12,5	73	140	2,07	50	083030010
M12	16,0	90	220	3,45	20	083030012

packs especiais



Ø mm	C mm	E mm	WFL kg	€		
M5	6,0	60	47,00	1	083030705	
M6	8,0	50	42,50	1	083030706	
M8	10,0	30	41,50	1	083030708	
M10	12,5	25	58,50	1	083030710	
M12	16,0	10	39,00	1	083030712	

packs especiais

packs especiais

8702N - 8702Z - 8702ZC

terminais em aço forjado

fechados
preto



CARACTERÍSTICAS TÉCNICAS

- código identificação
- TESTES LABORATORIAIS**
- análises químicas
- ensaio de tensão
- CERTIFICADOS DISPONÍVEIS**
- Especificações técnicas
- Relatório de teste UNI EN10204 tipo 2.2
- Certificado de inspeção UNI EN10204 tipo 3.1

M	Ø B mm	Ø A mm	Ø D mm	€		
6	6,8	13	19	50,00	1	087020106
8	8,8	20	22	60,00	1	087020108
9	9,8	20	22	60,00	1	087020109
10	10,8	20	22	60,00	1	087020110
11	11,8	25	27	74,50	1	087020111
12	12,8	25	27	74,50	1	087020112
13	13,8	25	27	74,50	1	087020113
14	14,8	32	32	103,00	1	087020114
15	15,9	32	32	103,00	1	087020115
16	17,0	32	32	103,00	1	087020116
18	19,0	39	37	134,00	1	087020118
19	20,0	39	37	134,00	1	087020119
20	21,1	39	37	134,00	1	087020120
22	23,2	43	43	186,00	1	087020122
24	25,4	50	52	214,00	1	087020124
25	26,4	50	52	214,00	1	087020125
26	27,4	50	52	214,00	1	087020126

8702Z galvanização

M	Ø B mm	Ø A mm	Ø D mm	€		
6	6,8	13	19	52,00	1	087020306
8	8,8	20	22	63,00	1	087020308
9	9,8	20	22	63,00	1	087020309
10	10,8	20	22	63,00	1	087020310
11	11,8	25	27	77,50	1	087020311
12	12,8	25	27	77,50	1	087020312
13	13,8	25	27	77,50	1	087020313
14	14,8	32	32	109,00	1	087020314
15	15,9	32	32	109,00	1	087020315
16	17,0	32	32	109,00	1	087020316
18	19,0	39	37	140,00	1	087020318
19	20,0	39	37	140,00	1	087020319
20	21,1	39	37	140,00	1	087020320
22	23,2	43	43	192,00	1	087020322
24	25,4	50	52	224,00	1	087020324
25	26,4	50	52	224,00	1	087020325
26	27,4	50	52	224,00	1	087020326

8702ZC galvanização a quente

M	Ø B mm	Ø A mm	Ø D mm	€		
6	6,8	13	19	55,50	1	087020206
8	8,8	20	22	68,50	1	087020208
9	9,8	20	22	68,50	1	087020209
10	10,8	20	22	68,50	1	087020210
11	11,8	25	27	85,00	1	087020211
12	12,8	25	27	85,00	1	087020212
13	13,8	25	27	85,00	1	087020213
14	14,8	32	32	125,00	1	087020214
15	15,9	32	32	125,00	1	087020215
16	17,0	32	32	125,00	1	087020216
18	19,0	39	37	162,00	1	087020218
19	20,0	39	37	162,00	1	087020219
20	21,1	39	37	162,00	1	087020220
22	23,2	43	43	219,00	1	087020222
24	25,4	50	52	256,00	1	087020224
25	26,4	50	52	256,00	1	087020225
26	27,4	50	52	256,00	1	087020226

8709N - 8709Z - 8709ZC

terminais em aço forjado

abertos

preto



CARACTERÍSTICAS TÉCNICAS

• código identificação

TESTES LABORATORIAIS

• análises químicas

• ensaio de tensão

CERTIFICADOS DISPONÍVEIS

• Especificações técnicas

• Relatório de teste UNI EN10204 tipo 2.2

• Certificado de inspeção UNI EN10204 tipo 3.1

M	Ø B mm	Ø A mm	Ø C mm	€		
6	6,8	13	17	68,50	1	087090106
8	8,8	20	21	88,50	1	087090108
9	9,8	20	21	88,50	1	087090109
10	10,8	20	21	88,50	1	087090110
11	11,8	25	25	111,00	1	087090111
12	12,8	25	25	111,00	1	087090112
13	13,8	25	25	111,00	1	087090113
14	14,8	32	30	154,00	1	087090114
15	15,9	32	30	154,00	1	087090115
16	17,0	32	30	154,00	1	087090116
18	19,0	39	35	200,00	1	087090118
19	20,0	39	35	200,00	1	087090119
20	21,1	39	35	200,00	1	087090120
22	23,2	43	41	255,00	1	087090122
24	25,4	50	51	262,00	1	087090124
25	26,4	50	51	262,00	1	087090125
26	27,4	50	51	262,00	1	087090126

8709Z galvanização

M	Ø B mm	Ø A mm	Ø C mm	€		
6	6,8	13	17	70,50	1	087090306
8	8,8	20	21	92,50	1	087090308
9	9,8	20	21	92,50	1	087090309
10	10,8	20	21	92,50	1	087090310
11	11,8	25	25	115,00	1	087090311
12	12,8	25	25	115,00	1	087090312
13	13,8	25	25	115,00	1	087090313
14	14,8	32	30	162,00	1	087090314
15	15,9	32	30	162,00	1	087090315
16	17,0	32	30	162,00	1	087090316
18	19,0	39	35	209,00	1	087090318
19	20,0	39	35	209,00	1	087090319
20	21,0	39	35	209,00	1	087090320
22	23,2	43	41	275,00	1	087090322
24	25,4	50	51	275,00	1	087090324
25	26,4	50	51	275,00	1	087090325
26	27,4	50	51	275,00	1	087090326

8709ZC galvanização a quente

M	Ø B mm	Ø A mm	Ø C mm	€		
6	6,8	13	17	73,00	1	087090206
8	8,8	20	21	97,50	1	087090208
9	9,8	20	21	97,50	1	087090209
10	10,8	20	21	97,50	1	087090210
11	11,8	25	25	126,00	1	087090211
12	12,8	25	25	126,00	1	087090212
13	13,8	25	25	126,00	1	087090213
14	14,8	32	30	183,00	1	087090214
15	15,9	32	30	183,00	1	087090215
16	17,0	32	30	183,00	1	087090216
18	19,0	39	35	233,00	1	087090218
19	20,0	39	35	233,00	1	087090219
20	21,1	39	35	233,00	1	087090220
22	23,2	43	41	297,00	1	087090222
24	25,4	50	51	326,00	1	087090224
25	26,4	50	51	326,00	1	087090225
26	27,4	50	51	326,00	1	087090226

CERRA-CABOS



Os cerra-cabos profissionais para cabos de aço entrançados podem ser utilizados em sistemas de fixação e tensionamento. Ao contrário de muitos produtos disponíveis no mercado, os nossos cerra-cabos NÃO possuem corpos de ferro fundido.

Na verdade, para garantir um desempenho mecânico ideal em trabalhos pesados, as bases são forjadas a quente e são, em média, mais pesadas que artigos similares.

A galvanização eletrolítica de qualidade, isenta de crômio hexavalente, proporciona boa resistência à corrosão e melhora a aparência.

Durante as várias décadas de história da Empresa, todas estas características transformaram o artigo 8016 no ícone da marca Robur, permitindo que os cerra-cabos de "tipo italiano" se destacassem em todo o mundo.

8015

cerra cabos, tipo Americano, em aço, galvanização a quente

CE

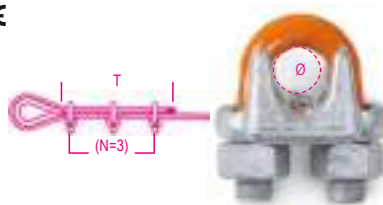

dimensioni EN 13411-5 tipo B

Características técnicas:

• código de identificação

TESTES LABORATORIAIS

• análise química

• ensaio de binário

CERTIFICADOS DISPONÍVEIS

• Especificações técnicas

• Relatório de teste UNI EN10204 tipo 2.2

• Certificado do fabricante UNI EN13411-5

• Declaração de Conformidade CE

Ø mm	Ø "	NxT	Nm	€		
8	5/16	3x133	40,7	2,48	12	080150808
10	3/8	3x165	61	3,45	12	080150810
13	1/2	3x292	88	5,40	6	080150813
16	5/8	3x305	129	7,60	6	080150816
20	3/4	4x460	176	10,40	6	080150820
22	7/8	4x480	305	16,50	6	080150822
26	1	5x660	305	18,00	5	080150826
30	1-1/8	6x860	305	19,30	2	080150830

8016

cerra cabos em aço zincados

CE

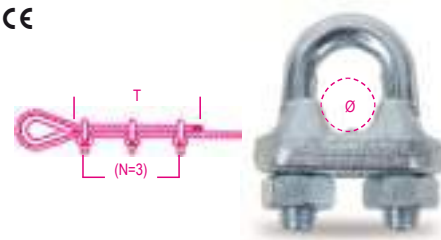

CARACTERÍSTICAS TÉCNICAS

• análise química

• teste binário

CERTIFICADOS DISPONÍVEIS

• Especificações técnicas

• Relatório de ensaio UNI EN10204 tipo 2.2

• Certificado de Conformidade CE

Ø mm	Ø "	N x T	Nm	€		
3	1/8	3x80	1,53	0,67	500	080160003
5	3/16	3x110	3,02	0,85	300	080160005
6	1/4	3x120	5,19	0,94	200	080160006
8	5/16	5x210	5,19	1,16	150	080160008
10	3/8	5x240	12,54	1,75	70	080160010
11	7/16	5x260	12,54	1,89	70	080160011
12-13	1/2	5x300	24,76	2,53	40	080160013
14	9/16	5x295	24,76	2,75	35	080160014
16	5/8	5x335	24,76	3,25	30	080160016
18	11/16	5x380	42,42	4,40	30	080160018
20	3/4	5x540	42,42	4,75	30	080160020
22	7/8	7x595	42,42	5,60	25	080160022
24-26	1"	7x700	67,56	7,70	15	080160026
28	1"1/16	8x840	67,56	9,60	5	080160028
30-32	1"1/8	8x990	67,56	9,70	5	080160030
34-36	1"1/4	8x1155	105,80	12,80	4	080160034
38-40	1"1/2	8x1320	105,80	17,20	2	080160040
45-50	2"	8x1500	206	26,50	1	080160050

confeção especial



Ø mm	Ø "	N x T	Nm	€		
3	1/8	100		76,00	1	080160703
5	3/16	50		48,00	1	080160705
6	1/4	50		53,50	1	080160706
8	5/16	30		39,50	1	080160708
10	3/8	30		59,50	1	080160710
11	7/16	25		53,50	1	080160711
12-13	1/2	15		42,50	1	080160713

Embalagens especiais com blister



Ø mm		€		
3	6	5,10	1	080169403
5	4	4,45	1	080169405
6	4	5,00	1	080169406
8	4	5,80	1	080169408
10	2	4,60	1	080169410
11	1	3,35	1	080169011
12-13	1	3,95	1	080169013
14	1	4,15	1	080169014
16	1	4,60	1	080169016
18	1	5,90	1	080169018
20	1	6,00	1	080169020
22	1	7,10	1	080169022
24-26	1	9,30	1	080169026

8016FR

cerra-cabos em ferro galvanizado

CE

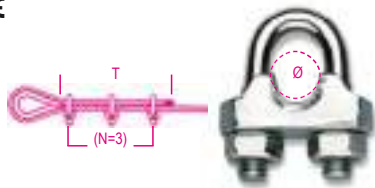

TESTES LABORATORIAIS

- análise química
- CERTIFICADOS DISPONÍVEIS
- Especificações técnicas
- Relatório de ensaio UNI EN10204 tipo 2.2
- Certificado de Conformidade CE

Ø	Ø	N x T	Nm	€		
mm	mm					
3	1/8	3x80	1,25	0,61	500	080160253
5	3/16	3x110	2,46	0,73	300	080160255
6	1/4	3x120	4,24	0,89	200	080160256
8	5/16	5x210	4,24	1,03	150	080160258

8018E

cerra cabos zincado



TESTES LABORATORIAIS

- análise química
- CERTIFICADOS DISPONÍVEIS
- Especificações técnicas
- Relatório de ensaio UNI EN10204 tipo 2.2

Ø	A	L	Nm	€		
mm	mm	mm				
4÷6	M6	34	4,24	1,35	100	080180001

Robur

8016U2

cerra cabos galvanizado

CE

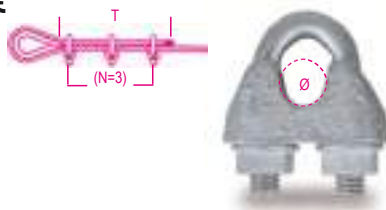

dimensioni EN 13411-5 tipo A

CARACTERÍSTICAS TÉCNICAS • código de identificação • análise química • teste binário • CERTIFICADOS DISPONÍVEIS • Especificações técnicas • Relatório de ensaio UNI EN10204 tipo 2.2 • Certificado do fabricante UNI EN13411-5 • Certificado de Conformidade CE

Ø	Ø	N x T	Nm	€		
mm	mm					
5	3/16	3x156	2,0	0,36	300	080160855
6,5	1/4	3x192	3,5	0,49	150	080160856
8	5/16	4x320	6	1,00	70	080160858
10	3/8	4x320	9	1,05	60	080160860
12	1/2	4x384	20	1,99	25	080160862
14	9/16	4x448	33	3,10	15	080160864
16	5/8	4x512	49	4,60	10	080160866
19	3/4	4x512	68	5,40	10	080160869
22	7/8	5x680	107	7,70	10	080160872
26	1	5x760	147	13,90	5	080160876
30	1.1/8	6x984	212	17,80	5	080160880
34	1.1/4	6x1080	296	24,40	5	080160884
40	1.1/2	6x1176	363	30,00	5	080160890

Embalagens especiais com blister

Ø		€		
mm				
5	4	4,40	1	080169805
6	4	5,60	1	080169806
8	4	8,60	1	080169808
10	2	5,80	1	080169810
12	1	5,60	1	080169612
14	1	6,40	1	080169614
16	1	8,60	1	080169616
19	1	9,40	1	080169619
22	1	12,20	1	080169622
26	1	20,00	1	080169626

Robur

8016UGK

cerra-cabos,
em ferro fundido maleável,
corpo GALVANIZADO A QUENTE,
parafusos e cavilhas GEOMET-GEOKOTE

CE



- elevada
resistência à
corrosão
- código de
identificação

dimensioni EN 13411-5 tipo A

CARACTERÍSTICAS TÉCNICAS

- código identificação
- TESTES LABORATORIAIS
- análise química
- teste binário
- CERTIFICADOS DISPONÍVEIS
- Especificações técnicas
- Relatório de teste UNI EN10204 tipo 2.2
- Certificado Fabricante UNI EN13411-5
- Declaração de Conformidade CE

Ø	Ø	N x T	Nm	€		
mm	mm					
8	5/16	4x320	6	1,99	70	080160758
10	3/8	4x320	9	2,20	60	080160760
12	1/2	4x448	33	3,95	25	080160762
14	9/16	4x384	20	5,80	15	080160764
16	5/8	4x512	49	8,60	10	080160766
19	3/4	4x512	68	9,70	10	080160769
22	7/8	5x680	107	13,90	10	080160772
26	1	5x760	147	22,70	5	080160776
30	1,1/8	6x984	212	27,50	1	080160780
34	1,1/4	6x1080	296	39,00	1	080160784
40	1,1/2	6x1176	363	48,50	1	080160790

8018T

cerra cabos zincado



RUM-MU-21:1980

TESTES LABORATORIAIS

- análise química
- CERTIFICADOS DISPONÍVEIS
- Especificações técnicas
- Relatório de ensaio UNI EN10204 tipo 2.2

Ø	A	L	Nm	€		
mm	mm	mm				
8÷10	M8	42	10,20	1,38	200	080180003

Robur

8020A

guarda-cabos, modelo italiano,
galvanizados

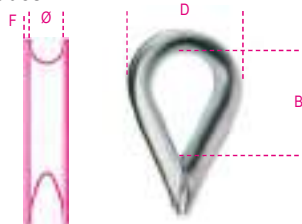

CERTIFICADOS DISPONÍVEIS

- Especificações técnicas
- Relatório de teste UNI EN10204 tipo 2.2

Ø mm	F mm	B mm	D mm	€		
2-3	1,0	20	18	0,25	150	080200503
4	1,2	23	19	0,26	150	080200504
5	1,2	24	23	0,30	100	080200505
6	1,2	27	28	0,31	100	080200506
8	1,4	33	32	0,49	50	080200508
10	1,8	41	38	0,72	30	080200510
12	2,2	44	45	0,95	30	080200512
14	2,2	52	49	1,22	50	080200514
16	3,0	58	58	1,72	50	080200516
18	3,7	64	68	2,42	50	080200518
20	3,7	73	74	3,15	35	080200520
22	3,7	83	79	3,50	30	080200522
24	3,7	93	88	4,60	20	080200525

confeção especial



Ø mm	S mm	€		
2-3	0,8	150	38,00	1 080200703
4	1,0	150	39,50	1 080200704
5	1,0	100	30,50	1 080200705
6	1,0	100	31,50	1 080200706
8	1,2	50	24,70	1 080200708
10	1,5	30	21,80	1 080200710

8021A

guarda cabos

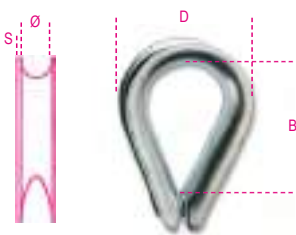

CERTIFICADOS DISPONÍVEIS

- Especificações técnicas
- Relatório de ensaio UNI EN10204 tipo 2.2

Ø mm	S mm	B mm	D mm	€		
2-3	0,6	15	16	0,40	150	080210103
5	1,7	29	28	0,58	120	080210105
6	1,8	33	30	0,65	100	080210106
8	2,5	36	37	0,88	100	080210108
10	2,5	42	43	1,07	80	080210110
12	2,5	48	50	1,38	100	080210112
14	2,7	58	57	1,85	70	080210114
16	3	61	62	2,26	50	080210116
18	3,5	71	71	2,96	70	080210118
20	4	79	79	4,40	30	080210120
22	4	87	84	5,10	25	080210122
24	4	93	92	6,00	25	080210124
26	4	103	103	7,50	20	080210126
28	5	107	116	17,40	1	080210128
30	5	118	121	17,40	1	080210130
32	5,5	138	135	20,80	1	080210132
35	6	140	147	29,00	1	080210135
40	6,0	174	170	41,00	1	080210140

MANILHAS



Ao contrário de produtos similares, as manilhas de alta resistência da Robur são feitas inteiramente de liga de aço cromo molibdênio endurecido e temperado e concebidas para exceder 20.000 ciclos de carga total em testes de laboratório. Destacam-se, portanto, na sua categoria, como a melhor opção para trabalhos pesados, com fator de segurança superior aos padrões de referência (6:1 em vez de 5:1) e excelente resiliência em baixas temperaturas.

As manilhas de aço macio da Robur são sinônimo de fiabilidade e eficácia, baseadas em matéria-prima de alta qualidade, excelente acabamento mecânico e tratamento térmico (normalizado), que permitem alcançar uma elevada carga de trabalho e fator de segurança em comparação com produtos equivalentes disponíveis no mercado.

A marcação clara e indelével em cada peça permite identificar a origem da manilha, por ex. no caso de inspeções por empresas de auditoria ou órgãos competentes.

8026R

manilhas direitas,
aço de elevada resistência,
pino de anel, zincadas a quente

CE



EN 13889

CARACTERÍSTICAS TÉCNICAS

- fator de segurança mínimo: 6
- tratamento a quente: endurecimento e reforço
- código de detecção no pino e na estrutura
- TESTES LABORATORIAIS
- análise química • análise metalográfica
- teste elasticidade • teste de fadiga (min. 20,000 ciclos)
- teste prova de carga (2 x WLL)

CERTIFICADOS DISPONÍVEIS

- Especificações do Produto
- Relatório de Teste UNI EN10204 tipo 2.2
- Certificado de Inspeção UNI EN10204 tipo 3.1
- Declaração de Conformidade CE

ØD mm	ØA mm	H mm	WLL kg	€		
11	10	17	1000	6,80	5	080260210
16	13	21	2000	12,50	5	080260212
19	16	27	3250	21,20	3	080260216
22	19	32	4750	30,50	2	080260219
25	22	37	6500	47,00	2	080260222

Embalagens especiais com blister



ØD mm		€			
16	1	13,70	1	080269212	
19	1	22,70	1	080269216	

8029R

manilhas tipo lira, pino de aperto
em aço de elevada resistência,
zincadas a quente

CE

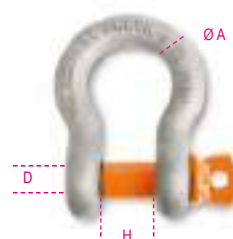

EN 13889

CARACTERÍSTICAS TÉCNICAS

- fator de segurança mín.: 6
- tratamento a quente: reforçado e temperado
- código de localização no pino e corpo
- teste de fadiga (min. 20,000 ciclos)
- teste prova de carga (2 x WLL)

CERTIFICADOS DISPONÍVEIS

- Especificações de Produto
- Relatório de Teste UNI EN10204 tipo 2.2
- Certificado de Inspeção UNI EN10204 tipo 3.1
- Declaração de Conformidade CE

ØD mm	ØA mm	H mm	WLL kg	€		
8	6	13	500	4,10	20	080290106
10	8	13,5	750	5,00	15	080290108
11	10	17	1000	7,10	15	080290110
13	11	18,5	1500	9,40	10	080290111
16	13	20,5	2000	9,70	8	080290112
19	16	27	3250	16,50	8	080290116
22	19	32	4750	24,30	4	080290120
25	22	37	6500	36,50	4	080290122
28	26	43,5	8500	50,00	1	080290124

Robur

ØD mm	ØA mm	H mm	WLL kg	€		
32	29	48	9500	93,00	1	080290128
35	32	53	12000	125,00	1	080290132
38	35	59	13500	164,00	1	080290135
42	38	62	17000	214,00	1	080290138
50	45	75	25000	366,00	1	080290145
57	50	83	35000	640,00	1	080290150
65	57	95	42500	1.110,00	1	080290157
70	65	105	55000	1.260,00	1	080290165

Embalagens especiais com blister



ØD mm		€		
8	1	5,60	1	080299106
10	1	6,40	1	080299108
11	1	8,60	1	080299110
13	1	10,90	1	080299111
16	1	11,10	1	080299112
19	1	18,60	1	080299116

packs especiais



ØD mm	ØA mm		€		
8	6	10	46,00	1	080290706
10	8	10	56,50	1	080290708
11	10	10	79,50	1	080290710
13	11	5	52,50	1	080290711
16	13	4	43,00	1	080290712
19	16	4	74,50	1	080290716
22	19	2	55,00	1	080290720
25	22	2	81,50	1	080290722

8031R

manilhas tipo lira, parafuso de segurança em aço de elevada resistência, zincadas a quente

CE



EN 13889

CARACTERÍSTICAS TÉCNICAS

- factor de segurança mín.: 6
- tratamento a quente: reforçado e temperado
- código de localização no pino e corpo
- teste de fadiga (mín. 20,000 ciclos)
- teste prova de carga (2 x WLL)

CERTIFICADOS DISPONÍVEIS

- Especificações de Produto
- Relatório de Teste UNI EN10204 tipo 2.2
- Certificado de Inspeção UNI EN10204 tipo 3.1
- Declaração de Conformidade CE

ØD mm	ØA mm	H mm	WLL kg	€		
11	10	17	1000	7,60	5	080310110
13	11	18	1500	11,70	5	080310111
16	13	21	2000	11,90	5	080310112
19	16	27	3250	20,40	3	080310116
22	19	32	4750	29,00	2	080310120
25	22	37	6500	40,00	2	080310122
28	26	43	8500	59,50	1	080310124

ØA mm	ØD mm	H mm	WLL kg	€		
29	32	48	9500	102,00	1	080310128
32	35	53	12000	132,00	1	080310132
35	38	59	13500	186,00	1	080310135
38	42	62	17000	227,00	1	080310138
45	50	75	25000	396,00	1	080310145
50	57	83	35000	700,00	1	080310150
65	70	105	55000	1.430,00	1	080310165
75	83	127	85000	2.160,00	1	080310183

Embalagens especiais com blister



ØD mm		€		
16	1	14,70	1	080319112
19	1	24,90	1	080319116

8032

manilhas tipo lira, aço de elevada resistência, pino quadrado, zincadas a quente

CE

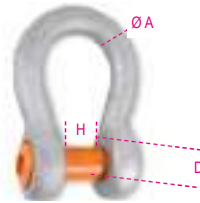

CARACTERÍSTICAS TÉCNICAS

- factor segurança mínimo: 6
- tratamento a quente: endurecimento e reforço
- código de detecção no pino e corpo

TESTES LABORATORIAIS

- análise química
- análise metalográfica
- teste de elasticidade
- teste de fadiga (mín. 20,000 ciclos)
- teste prova de carga (2 x WLL)

CERTIFICADOS DISPONÍVEIS

- Especificações Técnicas
- Relatório de Teste UNI EN10204 tipo 2.2
- Certificado de Inspeção UNI EN10204 tipo 3.1
- Declaração de Conformidade CE

ØD mm	ØA mm	H mm	WLL kg	€		
11	10	17	1000	9,00	5	080320010
16	13	21	2000	11,40	5	080320012
19	16	27	3250	20,70	3	080320016
22	19	32	4750	35,50	2	080320020
25	22	37	6500	52,00	2	080320022

Embalagens especiais com blister



ØD mm		€		
16	1	13,70	1	080329012
19	1	22,70	1	080329016



8025

manilhas direitas, largas, forjadas a quente em aço de carbono, zincadas

CE



CARACTERÍSTICAS TÉCNICAS

- factor de segurança: 5
- tratamento térmico: normalizador
- código de identificação

TESTES LABORATORIAIS

- análise química
- análise metalográfica
- ensaio de tracção

CERTIFICADOS DISPONÍVEIS

- Especificações técnicas
- Relatório de ensaio UNI EN10204 tipo 2.2
- Certificado de inspeção UNI EN10204 tipo 3.1
- Declaração de Conformidade CE

Ø mm	≈ "	B x C mm	WLL kg	€		
5	3/16	21x10	70	1,58	250	080250005
6	1/4	25x12	100	2,14	250	080250006
8	5/16	33x16	250	3,55	150	080250008
10	3/8	42x20	400	3,95	180	080250010
11	7/16	46x22	500	4,85	130	080250011
12	1/2	50x24	600	5,20	100	080250012
14	9/16	57x28	800	6,80	70	080250014
16	5/8	61x32	1000	8,90	10	080250016
18	11/16	65x36	1300	12,90	10	080250018
20	3/4	70x40	1600	15,10	10	080250020
22	7/8	74x44	2000	20,80	10	080250022
25	1"	80x48	2800	28,00	2	080250025

confeção especial



Ø mm		€			
5	3/16	25	44,50	1	080250705
6	1/4	25	60,50	1	080250706
8	5/16	25	101,00	1	080250708
10	3/8	15	66,50	1	080250710
11	7/16	12	65,50	1	080250711
12	1/2	12	70,50	1	080250712
14	9/16	10	76,50	1	080250714

Embalagens especiais com blister



Ø mm		€		
5	4	8,00	1	080259205
6	4	10,20	1	080259206
8	2	8,60	1	080259208
10	2	9,20	1	080259210
11	1	6,00	1	080259011
12	1	6,60	1	080259012
14	1	8,00	1	080259014
16	1	10,10	1	080259016
18	1	15,10	1	080259018
20	1	17,00	1	080259020
22	1	22,10	1	080259022
25	1	29,00	1	080259025

8026A

manilhas direitas,
forjadas a quente em aço carbono,
UNI 1947 tipo A, zincadas

CE



CARACTERÍSTICAS TÉCNICAS

- factor de segurança: 5
- tratamento térmico: normalizador
- código de identificação

TESTES LABORATORIAIS

- análise química
- análise metalográfica
- ensaio de tracção

CERTIFICADOS DISPONÍVEIS

- Especificações técnicas
- Relatório de ensaio UNI EN10204 tipo 2.2
- Certificado de inspeção UNI EN10204 tipo 3.1
- Declaração de Conformidade CE

Ø mm	≈	B x C mm	WLL kg	€		
12	1/2	42x20	630	5,00	35	080260012
14	9/16	46x22	800	6,20	30	080260014
16	5/8	50x24	1000	8,00	20	080260016
18	11/16	54x26	1300	11,30	15	080260018
20	3/4	58x28	1600	14,20	10	080260020
22	7/8	69x32	2000	18,60	10	080260022
25	1"	79x36	2500	26,50	5	080260025
28	1.1/8	90x40	3150	36,50	2	080260028
32	1.1/4	100x45	4000	50,00	1	080260032
36	1.3/8	110x50	5000	71,50	1	080260036
40	1.9/16	120x55	6300	99,00	1	080260040
42	1.5/8	131x60	8000	135,00	1	080260042
45	1.3/4	143x65	10000	185,00	1	080260045
50	2"	155x70	12500	229,00	1	080260050

Embalagens especiais com blister



Ø mm		€		
12	1	6,50	1	080269012
14	1	7,70	1	080269014
16	1	9,00	1	080269016
18	1	13,70	1	080269018
20	1	16,30	1	080269020
22	1	20,80	1	080269022
25	1	29,00	1	080269025

Robur

8028

manilhas tipo lira,
forjadas a quente em aço carbono,
zincadas

CE

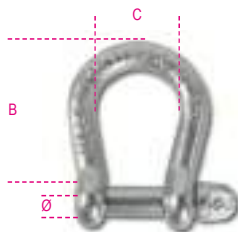

CARACTERÍSTICAS TÉCNICAS

- factor de segurança: 5
- tratamento térmico: normalizador
- código de identificação

TESTES LABORATORIAIS

- análise química
- análise metalográfica
- ensaio de tracção

CERTIFICADOS DISPONÍVEIS

- Especificações técnicas
- Relatório de ensaio UNI EN10204 tipo 2.2
- Certificado de inspeção UNI EN10204 tipo 3.1
- Declaração de Conformidade CE

Ø mm	≈	B x C mm	WLL kg	€		
5	3/16	20x16	80	1,36	100	080280105
6	1/4	24x20	100	2,03	70	080280106
8	5/16	32x24	200	3,50	35	080280108
10	3/8	40x33	300	4,05	25	080280110
12	1/2	48x39	500	6,50	15	080280112
14	9/16	56x46	600	9,20	7	080280114
16	5/8	64x46	800	13,80	10	080280116
18	11/16	71x59	950	17,00	5	080280118
20	3/4	80x65	1100	24,30	5	080280120
22	7/8	88x72	1500	30,50	5	080280122
25	1"	100x81	2000	47,00	2	080280125
28	1.1/8	112x91	2600	72,50	1	080280128
32	1.1/4	128x104	3200	99,50	1	080280132
38	1.1/2	152x124	4500	198,00	1	080280138

Embalagens especiais com blister



Ø mm		€		
5	4	6,80	1	080289305
6	4	9,80	1	080289306
8	2	8,80	1	080289308
10	2	9,50	1	080289310
12	1	7,90	1	080289112
14	1	10,50	1	080289114
16	1	15,00	1	080289116
18	1	18,90	1	080289118
20	1	26,00	1	080289120
22	1	33,50	1	080289122

8049 WLL (t)

	A°	M8	M10	M12	M16	M20	M24	M30
	0°	0,3	0,6	1	1,6	2,5	4	6,3
	0°	0,6	1,2	2	3,2	5	8	12,6
	90°	0,3	0,6	1	1,6	2,5	4	6,3
	90°	0,6	1,2	2	3,2	5	8	12,6
	0°/45°	0,4	0,8	1,4	2,2	3,5	5,6	8,8
	45°/60°	0,3	0,6	1	1,6	2,5	4	6,3
	0°/45°	0,6	1,3	2,1	3,4	5,3	8,4	12,2
	45°/60°	0,3	0,6	1	1,6	2,3	4	6,3

8049

argolas de elevação ajustáveis,
articulação dupla,
liga de aço de elevada resistência

CE

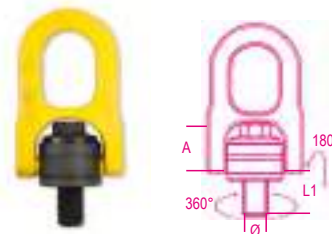

CARACTERÍSTICAS TÉCNICAS

- factor de segurança: 5
- tratamento térmico: endurecido e temperado
- código de identificação

TESTES LABORATORIAIS

- análise química
- análise metalográfica
- ensaio de tracção

CERTIFICADOS DISPONÍVEIS

- teste de fadiga (20,000 ciclos)
- Especificações técnicas
- Relatório de ensaio UNI EN10204 tipo 2.2
- Certificado de inspeção UNI EN10204 tipo 3.1
- Declaração de Conformidade CE

Ø mm	A mm	L1 mm	WLL 90° kg	€		
M8	31,5	14	300	137,00	1	080490008
M10	31,5	17	600	143,00	1	080490010
M12	31,5	21	1000	146,00	1	080490012
M16	45	27	1600	168,00	1	080490016
M20	45	30	2500	173,00	1	080490020
M24	60,5	36	4000	296,00	1	080490024
M30	60,5	45	6300	308,00	1	080490030

Robur

Robur

8049A WLL (kg)											
	Ø	M6	M8	M10	M12	M16	M20	M24	M30	M36	M42
	Ø	400	600	900	1300	2000	3000	4500	6000	9000	13000
	Ø	800	1200	1800	2600	4000	6000	9000	13000	20000	29000
	10°	200	300	450	600	900	1300	2000	3000	4500	6000
	10°	400	600	900	1300	2000	3000	4500	6000	9000	13000
	Ø	250	400	600	700	1400	2000	450	700	1000	1500
	45°	200	300	450	500	1100	2000	3750	5000	8000	12000
	Ø	400	600	900	1300	2100	3000	6000	9000	13000	19000
	45°	250	400	600	750	1500	2000	4500	6000	9000	13000

8049A

argolas de elevação com articulação dupla, ajustáveis em carga, com anel soldado, liga de aço de elevada resistência

CE



CARACTERÍSTICAS TÉCNICAS

- fator de segurança: 4
 - tratamento térmico: endurecido
 - código de identificação
- TESTES LABORATORIAIS
- análise química
 - análise metalográfica
 - ensaio de tensão
 - teste de fadiga (20.000 ciclos)
 - teste de carga (100% da produção)

CERTIFICADOS DISPONÍVEIS

- Especificações técnicas
- Relatório de teste UNI EN10204 tipo 2.2
- Certificado de inspeção UNI EN10204 tipo 3.1
- Declaração de Conformidade CE

Ø	E	A	WLL 90°	€		
mm	mm	mm	kg			
M6	13	30	200	45,00	1	080490106
M8	13	30	300	46,00	1	080490108
M10	19	30	450	48,50	1	080490110
M12	19	30	500	51,50	1	080490112
M16	20	30	1120	55,00	1	080490116
M20	30	40	2000	79,00	1	080490120
M24	30	40	3150	116,00	1	080490124
M30	35	50	5300	200,00	1	080490130
M36	54	50	8000	210,00	1	080490136

8049V

argolas de elevação com suporte, liga de aço de elevada resistência, argola giratória 360° e suporte giratório

CE



Características técnicas:

- fator de segurança: 4
- tratamento térmico: endurecido e temperado
- código de identificação

TESTES LABORATORIAIS

- análise química
- análise metalográfica
- ensaio de tensão
- teste de fadiga (20.000 ciclos)
- teste de carga (100% da produção)

CERTIFICADOS DISPONÍVEIS

- Especificações técnicas
- Relatório de teste UNI EN10204 tipo 2.2
- Certificado de inspeção UNI EN10204 tipo 3.1
- Declaração de Conformidade CE

Ø	E	B	WLL	€		
mm	mm	mm	kg			
M10	13,5	37	630	76,00	1	080490310
M12	18	37,5	1000	92,50	1	080490312
M16	24	37,5	1500	99,00	1	080490316
M20	35,5	54	2500	144,00	1	080490320
M24	35,5	54	4000	148,00	1	080490324

8068S

suporte para elevação de carga, base simples, com molas de posicionamento, em liga de aço de elevada resistência

- Dimensões compactas para operações de elevação
- Testado para suportar 20.000 ciclos de trabalho em carga máxima
- Carga de teste aplicada a 100% das peças antes da venda
- Fator de segurança: 4, em todas as direções

CE



CARACTERÍSTICAS TÉCNICAS

- fator de segurança: 4
 - tratamento térmico: endurecido
 - código de identificação
- TESTES LABORATORIAIS
- análise química
 - análise metalográfica
 - ensaio de tensão
 - teste de fadiga (20.000 ciclos)
 - teste de carga (100% da produção)

CERTIFICADOS DISPONÍVEIS

- Especificações técnicas
- Relatório de teste UNI EN10204 tipo 2.2
- Certificado de inspeção UNI EN10204 tipo 3.1
- Declaração de Conformidade CE

WLL	B	M	A	€		
Kg	mm	mm	mm			
1500	78	37	41	11,20	1	080680115
2500	88	40	42	14,60	1	080680125
4000	94	42	45	20,90	1	080680140
6700	118	51	55	39,00	1	080680167

Atenção:

- O elemento de acoplamento deve proporcionar resistência mecânica adequada e ser apropriado para soldadura.
- Os trabalhos de soldadura devem ser realizados por pessoal qualificado.

8041

argolas de elevação, liga de aço de elevada resistência

CE



CARACTERÍSTICAS TÉCNICAS

- fator de segurança: 4
- tratamento térmico: endurecido e temperado
- código de identificação

TESTES LABORATORIAIS

- análise química
- ensaio de tração
- teste de fadiga (20.000 ciclos)
- teste prova de carga (100% do lote)

CERTIFICADOS DISPONÍVEIS

- Especificações técnicas
- Relatório de ensaio UNI EN10204 tipo 2.2
- Certificado de inspeção UNI EN10204 tipo 3.1
- Declaração de Conformidade CE

Ø	E	WLL	€		
mm	mm	kg			
M6	11	400	3,65	10	080410206
* M8	1,25	13	800	3,65	10 080410208
* M10	1,5	17	1000	5,70	6 080410210
* M12	1,75	20,5	1600	8,60	4 080410212
* M14	2	20,5	3000	14,20	2 080410214
M16	2,5	27	4000	21,50	2 080410217
M18	2,5	27	5000	21,50	2 080410218
M20	3,0	30	6000	40,00	2 080410221
M22	2,5	30	7000	40,00	2 080410222
M24	3	36	8000	48,50	2 080410225
M27	3	41	10000	73,50	1 080410227
* M30	3,5	45	12000	73,50	1 080410230

(* Especificações dimensionais DIN 580:2010

WLL aumentado conforme as especificações técnicas dos produtos Robur

Embalagens especiais com blister

Ø	€		
mm			
* M8	1	5,90	1 080419208
* M10	1	8,30	1 080419210
* M12	1	11,40	1 080419212

Robur

Robur

8043

argolas de elevação,
liga de aço de elevada resistência

CE



CARACTERÍSTICAS TÉCNICAS

- fator de segurança: 4
 - tratamento térmico: endurecido e temperado
 - código de identificação
- ### TESTES LABORATORIAIS
- análise química
 - ensaio de tração
 - teste de fadiga (20,000 ciclos)
 - teste prova de carga (100% do lote)

CERTIFICADOS DISPONÍVEIS

- Especificações técnicas
- Relatório de ensaio UNI EN10204 tipo 2.2
- Certificado de inspeção UNI EN10204 tipo 3.1
- Declaração de Conformidade CE

Ø mm	F mm	WLL kg	€		
M6	1 20	400	3,55	10	080430206
* M8	1,25 20	800	3,55	10	080430208
* M10	1,50 25	1000	5,60	6	080430210
* M12	1,75 30	1600	8,50	4	080430212
M14	2 35	3000	13,90	2	080430214
M16	2 40	4000	20,10	2	080430217
M18	2,5 40	5000	20,10	2	080430218
M20	2,5 50	6000	39,00	2	080430221
M22	2,5 50	7000	39,00	2	080430222
M24	3 55	8000	45,00	2	080430225
M27	3 60	10000	70,50	1	080430227
* M30	3,5 60	12000	70,50	1	080430230

(* Especificações dimensionais DIN 582:2010

WLL aumentado conforme as especificações técnicas dos produtos Robur

Embalagens especiais com blister



Ø mm	F mm	€		
* M8	1	5,60	1	080439208
* M10	1	8,00	1	080439210
* M12	1	10,90	1	080439212

ARGOLAS E OLHAIS DE ELEVÇÃO

As argolas e olhas de elevação da Robur são fabricados em aço carbono macio, com adição de teor mínimo de alumínio, e devem cumprir rigorosos parâmetros relativos à granulometria do material, conforme a DIN580-582.

O excelente acabamento mecânico também contribui para fazer a diferença: a ranhura em relevo dos colares na base das argolas/olhas de elevação resulta numa melhor aderência e contato total com a superfície do corpo a ser elevado. Com base nestas características, os nossos parafusos/olhas de elevação são ideais para tarefas de elevação complexas e utilização intensiva, por ex. em ambientes com funcionamento em ciclo contínuo ou intervalos de temperatura de -20 °C ÷ +200 °C



8040EZ

argolas de elevação macho,
galvanizadas

CE



DIN 580:2018-04(**)

CARACTERÍSTICAS TÉCNICAS

- fator de segurança: 6
 - tratamento térmico: normalizador
 - código de identificação
- ### TESTES LABORATORIAIS

- análise química
- análise metalográfica
- ensaio de tração

CERTIFICADOS DISPONÍVEIS

- Especificações técnicas
- Relatório de ensaio UNI EN10204 tipo 2.2
- Certificado de inspeção UNI EN10204 tipo 3.1
- Declaração de Conformidade CE

Ø mm	F mm	E mm	WLL kg	€		
* M6	1 11	90	1,99	60	080400406	
M8	1,25 13	140	1,99	60	080400408	
M10	1,5 17	230	2,67	40	080400410	
M12	1,75 20,5	340	3,55	20	080400412	
* M14	2 20,5	480	4,70	20	080400414	
M16	2 27	700	5,90	10	080400416	
* M18	2,5 27	930	7,20	10	080400418	
M20	2,5 30	1200	9,20	10	080400420	
* M22	2,5 30	1450	11,80	10	080400422	
M24	3 36	1800	17,40	5	080400424	
* M27	3 41	2400	21,50	5	080400427	
M30	3,5 45	3200	35,50	2	080400430	
* M33	3,5 54	3900	50,00	2	080400433	
* M33F	2 54	3900	50,00	2	080400434	
M36	4 54	4600	51,50	2	080400436	
* M36F	3 54	4600	51,50	2	080400437	
M42	4,5 63	6300	94,50	1	080400442	
* M42F	3 63	6300	94,50	1	080400443	
M48	5 68	8600	152,00	1	080400448	
* M48F	3 68	8600	152,00	1	080400449	
M56	5,5 78	11500	248,00	1	080400456	
* M56F	4 78	11500	248,00	1	080400457	
M64	6 90	16000	365,00	1	080400464	
* M64F	4 90	16000	365,00	1	080400465	

*Tamanhos dimensionados de acordo com a Ficha Técnica Robur

packs especiais



Ø mm	F mm	€		
M6	1 20	44,50	1	080400906
M8	1,25 20	44,50	1	080400908
M10	1,5 20	60,50	1	080400910
M12	1,75 15	60,50	1	080400912

Embalagens especiais com blister



Ø mm	F mm	€		
M6	4	10,00	1	080409606
M8	4	10,00	1	080409608
M10	2	7,50	1	080409610
M12	1	5,10	1	080409412
* M14	1	6,00	1	080409414
M16	1	7,50	1	080409416
* M18	1	8,80	1	080409418
M20	1	10,50	1	080409420

Ø mm	F mm	€		
* M22	1	13,90	1	080409422
M24	1	18,70	1	080409424
* M27	1	23,50	1	080409427
M30	1	37,00	1	080409430

8040EN

argolas de elevação macho,
negras

CE



DIN 580:2018-04(**)

CARACTERÍSTICAS TÉCNICAS

- fator de segurança: 6
 - tratamento térmico: normalizador
 - código de identificação
- ### TESTES LABORATORIAIS

- análise química
- análise metalográfica
- ensaio de tração

CERTIFICADOS DISPONÍVEIS

- Especificações técnicas
- Relatório de ensaio UNI EN10204 tipo 2.2
- Certificado de inspeção UNI EN10204 tipo 3.1
- Declaração de Conformidade CE

Ø mm	F mm	E mm	WLL kg	€		
* M6	1 11	90	1,92	60	080400306	
M8	1,25 13	140	1,92	60	080400308	
M10	1,5 17	230	2,61	40	080400310	
M12	1,75 20,5	340	3,55	20	080400312	
* M14	2 20,5	480	4,45	20	080400314	
M16	2 27	700	5,60	10	080400316	
* M18	2,5 27	930	7,00	10	080400318	
M20	2,5 30	1200	8,60	10	080400320	
* M22	2,5 30	1450	11,30	10	080400322	
M24	3 36	1800	15,90	5	080400324	
* M27	3 41	2400	20,00	5	080400327	
M30	3,5 45	3200	33,50	2	080400330	
* M33	3,5 54	3900	47,00	2	080400333	
* M33F	2 54	3900	47,00	2	080400334	
M36	4 54	4600	49,50	2	080400336	
* M36F	3 54	4600	49,50	2	080400337	
M42	4,5 63	6300	91,00	1	080400342	
* M42F	3 63	6300	91,00	1	080400343	
M48	5 68	8600	149,00	1	080400348	
* M48F	3 68	8600	149,00	1	080400349	
M56	5,5 78	11500	237,00	1	080400356	
* M56F	4 78	11500	237,00	1	080400357	
M64	6 90	16000	345,00	1	080400364	
* M64F	4 90	16000	345,00	1	080400365	

*Tamanhos dimensionados de acordo com a Ficha Técnica Robur

Embalagens especiais com blister



Ø mm	F mm	€		
M6	4	9,40	1	080409506
M8	4	9,40	1	080409508
M10	2	6,90	1	080409510
M12	1	4,85	1	080409312
* M14	1	5,80	1	080409314
M16	1	6,90	1	080409316
* M18	1	8,20	1	080409318
M20	1	9,50	1	080409320
* M22	1	13,00	1	080409322
M24	1	17,40	1	080409324
* M27	1	21,50	1	080409327
M30	1	34,50	1	080409330

8042EZ

argolas de elevação macho, galvanizadas

CE



DIN582:2018-04(**)

CARACTERÍSTICAS TÉCNICAS

- fator de segurança: 6
- tratamento térmico: normalizador
- código de identificação

TESTES LABORATORIAIS

- análise química
- análise metalográfica
- ensaio de tração

CERTIFICADOS DISPONÍVEIS

- Especificações técnicas
- Relatório de ensaio UNI EN10204 tipo 2.2
- Certificado de inspeção UNI EN10204 tipo 3.1
- Declaração de Conformidade CE

Ø mm	WLL mm	F mm	WLL kg	€	📦	🚚
* M6	1	14	90	1,99	60	080420406
M8	1,25	20	140	1,99	60	080420408
M10	1,5	25	230	2,67	40	080420410
M12	1,75	30	340	3,65	30	080420412
* M14	2	30	480	4,70	30	080420414
M16	2	35	700	5,90	20	080420416
* M18	2,5	35	930	7,20	20	080420418
M20	2,5	40	1200	9,00	10	080420420
* M22	2,5	40	1450	11,70	10	080420422
M24	3	50	1800	17,40	5	080420424
* M27	3	55	2400	20,80	5	080420427
M30	3,5	60	3200	33,50	3	080420430
M36	4	70	4600	51,00	2	080420436
* M36F	3	70	4600	51,00	2	080420437
M42	4,5	80	6300	92,50	1	080420442
* M42F	3	80	6300	92,50	1	080420443
M48	5	90	8600	150,00	1	080420448
* M48F	3	90	8600	150,00	1	080420449

*Tamanhos dimensionados de acordo com a Ficha Técnica Robur

packs especiais



Ø mm	WLL mm	📦	€	🚚	
M6	1	20	43,00	1	080420906
M8	1,25	20	43,00	1	080420908
M10	1,5	20	59,00	1	080420910
M12	1,75	15	60,50	1	080420912

Embalagens especiais com blister



Ø mm	📦	€	🚚	
M6	4	9,70	1	080429606
M8	4	9,70	1	080429608
M10	2	7,00	1	080429610
M12	1	5,10	1	080429412
* M14	1	5,80	1	080429414
M16	1	7,20	1	080429416
* M18	1	8,30	1	080429418
M20	1	10,20	1	080429420
* M22	1	13,00	1	080429422
M24	1	20,00	1	080429424
* M27	1	22,10	1	080429427
M30	1	34,00	1	080429430



8042EN

argolas de elevação macho, negras

CE



DIN582:2018-04(**)

CARACTERÍSTICAS TÉCNICAS

- fator de segurança: 6
- tratamento térmico: normalizador
- código de identificação

TESTES LABORATORIAIS

- análise química
- análise metalográfica
- ensaio de tração

CERTIFICADOS DISPONÍVEIS

- Especificações técnicas
- Relatório de ensaio UNI EN10204 tipo 2.2
- Certificado de inspeção UNI EN10204 tipo 3.1
- Declaração de Conformidade CE

Ø mm	WLL mm	F mm	WLL kg	€	📦	🚚
* M6	1	14	90	1,92	60	080420306
M8	1,25	20	140	1,92	60	080420308
M10	1,5	25	230	2,55	40	080420310
M12	1,75	30	340	3,55	30	080420312
* M14	2	30	480	4,55	30	080420314
M16	2	35	700	5,40	20	080420316
* M18	2,5	35	930	6,90	20	080420318
M20	2,5	40	1200	8,30	10	080420320
* M22	2,5	40	1450	11,10	10	080420322
M24	3	50	1800	15,90	5	080420324
* M27	3	55	2400	19,30	5	080420327
M30	3,5	60	3200	30,50	3	080420330
M36	4	70	4600	47,00	2	080420336
* M36F	3	70	4600	47,00	2	080420337
M42	4,5	80	6300	87,00	1	080420342
* M42F	3	80	6300	87,00	1	080420343
M48	5	90	8600	143,00	1	080420348
* M48F	3	90	8600	143,00	1	080420349

*Tamanhos dimensionados de acordo com a Ficha Técnica Robur

Embalagens especiais com blister



Ø mm	📦	€	🚚	
M6	4	9,40	1	080429506
M8	4	9,40	1	080429508
M10	2	6,90	1	080429510
M12	1	4,70	1	080429312
* M14	1	5,60	1	080429314
M16	1	6,90	1	080429316
* M18	1	8,00	1	080429318
M20	1	9,70	1	080429320
* M22	1	12,50	1	080429322
M24	1	18,00	1	080429324
* M27	1	21,50	1	080429327
M30	1	32,50	1	080429330

8044

argolas fêmea, negras

CE



UNI 2948

CARACTERÍSTICAS TÉCNICAS

- fator de segurança: 4
- tratamento térmico: normalizador
- código de identificação

TESTES LABORATORIAIS

- análise química
- análise metalográfica
- ensaio de tração

CERTIFICADOS DISPONÍVEIS

- Especificações técnicas
- Relatório de ensaio UNI EN10204 tipo 2.2
- Certificado de inspeção UNI EN10204 tipo 3.1
- Declaração de Conformidade CE

Ø mm	WLL mm	WLL kg	€	📦	🚚
M8	1,25	80	2,55	4	080440008
M10	1,5	160	4,15	4	080440010
M12	1,75	250	7,30	4	080440012
M14	2	250	11,80	2	080440014
M16	2	400	11,90	2	080440016
M20	2,5	630	20,00	2	080440020
M24	3	1000	34,50	2	080440024



KIT DE ELEVÇÃO
Classe 8
Certificado de Fábrica
(UNI EM 818-4)

WLL Ton				UNI EN 818
Ø D mm	WLL 1	WLL 2		
		0° < β ≤ 45°	45° < β ≤ 60°	
6	1,12	1,6	1,12	
7	1,5	2,12	1,5	
8	2	2,6	2	
10	3,15	4,25	3,15	
13	5,3	7,5	5,3	
16	8	11,2	8	
Ø D mm	WLL 1	WLL 3		
		0° < β ≤ 45°	45° < β ≤ 60°	
6	2,36	1,7		
7	3,15	2,24		
8	4,25	3		
10	5,7	4,75		
13	11,2	8		
16	17	11,2		

8091

lingas de corrente, 1 secção
em estojo de plástico

Dispositivo de bloqueio automático e ganchos a pedido

CE

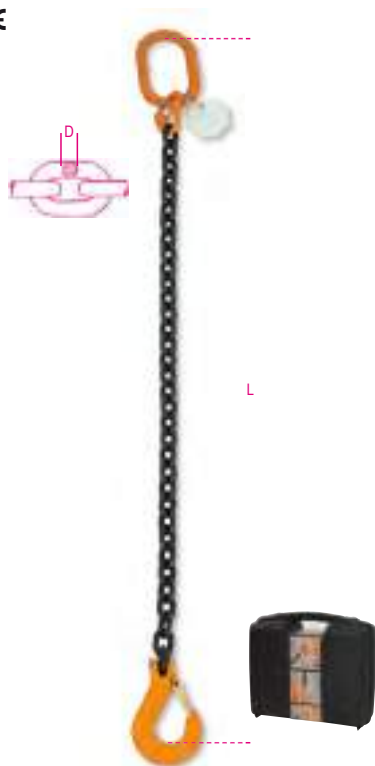

UNI EN 818-4

CARACTERÍSTICAS TÉCNICAS

- factor de segurança: 4
- etiqueta de identificação
- CERTIFICADOS DISPONÍVEIS
- Certificado do fabricante UNI EN818-4
- Declaração de Conformidade CE
- CERTIFICADOS DISPONÍVEIS
- Especificações técnicas

D mm	L m	WLL ton	€		
6*	1	1,12	94,00	1	080910001
6*	2	1,12	115,00	1	080910002
6*	3	1,12	137,00	1	080910003
6*	4	1,12	158,00	1	080910004
7*	1	1,5	103,00	1	080910021
7*	2	1,5	131,00	1	080910022
7*	3	1,5	158,00	1	080910023
7*	4	1,5	185,00	1	080910024
8*	1	2	115,00	1	080910041
8*	2	2	147,00	1	080910042
8*	3	2	180,00	1	080910043
8*	4	2	227,00	1	080910044
10*	1	3,15	148,00	1	080910051
10*	2	3,15	196,00	1	080910052
10*	3	3,15	259,00	1	080910053
10*	4	3,15	306,00	1	080910054
13*	1	5,3	239,00	1	080910131
13*	2	5,3	322,00	1	080910132
13*	3	5,3	399,00	1	080910133
13*	4	5,3	481,00	1	080910134
16*	1	8	469,00	1	080910161
16*	2	8	590,00	1	080910162
16*	3	8	715,00	1	080910163
16*	4	8	840,00	1	080910164
20	1	12,5	905,00	1	080910171
20	2	12,5	1.130,00	1	080910172
20	3	12,5	1.350,00	1	080910173
20	4	12,5	1.570,00	1	080910174

* Caixa de madeira apropriada ao peso

8091SL

lingas de corrente,
1 secção, gancho com autobloqueio,
grau 8

CE

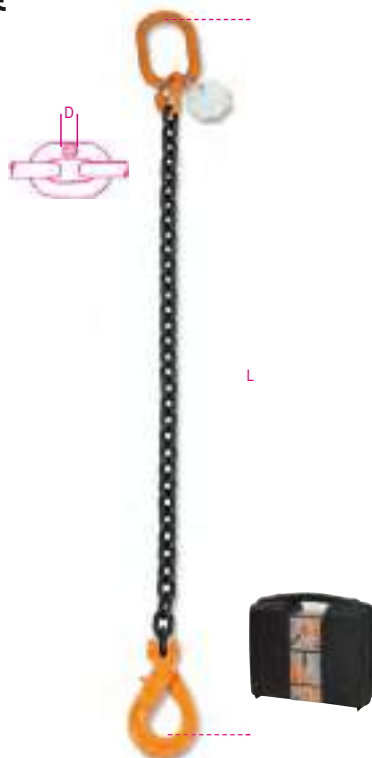

UNI EN 818-4

CARACTERÍSTICAS TÉCNICAS

- factor de segurança: 4
- etiqueta de identificação
- CERTIFICADOS ANEXOS
- Certificado do fabricante UNI EN818-4
- Declaração de Conformidade CE
- CERTIFICADOS DISPONÍVEIS
- Especificações técnicas

D mm	L m	WLL ton	€		
6*	1	1,12	119,00	1	080910201
6*	2	1,12	140,00	1	080910202
6*	3	1,12	162,00	1	080910203
6*	4	1,12	183,00	1	080910204
7*	1	1,5	136,00	1	080910221
7*	2	1,5	164,00	1	080910222
7*	3	1,5	191,00	1	080910223
7*	4	1,5	218,00	1	080910224
8*	1	2	149,00	1	080910241
8*	2	2	174,00	1	080910242
8*	3	2	213,00	1	080910243
8*	4	2	260,00	1	080910244
10*	1	3,15	186,00	1	080910251
10*	2	3,15	234,00	1	080910252
10*	3	3,15	297,00	1	080910253
10*	4	3,15	360,00	1	080910254
13*	1	5,3	329,00	1	080910331
13*	2	5,3	435,00	1	080910332
13*	3	5,3	493,00	1	080910333
13*	4	5,3	595,00	1	080910334
16*	1	8	620,00	1	080910361
16*	2	8	780,00	1	080910362
16*	3	8	865,00	1	080910363
16*	4	8	1.030,00	1	080910364
20	1	12,5	1.370,00	1	080910401
20	2	12,5	1.590,00	1	080910402
20	3	12,5	1.820,00	1	080910403
20	4	12,5	2.040,00	1	080910404

* Em estojo de plástico

8092

lingas de corrente, 2 secções
em estojo de plástico

Dispositivo de bloqueio automático e ganchos a pedido

CE



EN 818-4

CARACTERÍSTICAS TÉCNICAS

- factor de segurança: 4
- etiqueta de identificação
- CERTIFICADOS DISPONÍVEIS
- Certificado do fabricante UNI EN818-4
- Declaração de Conformidade CE
- CERTIFICADOS DISPONÍVEIS
- Especificações técnicas

D mm	L m	WLL ton	€		
6*	1	1,6	139,00	1	080920001
6*	2	1,6	182,00	1	080920002
6*	3	1,6	224,00	1	080920003
6*	4	1,6	282,00	1	080920004
7*	1	2,12	162,00	1	080920021
7*	2	2,12	216,00	1	080920022
7*	3	2,12	286,00	1	080920023
7*	4	2,12	341,00	1	080920024
8*	1	2,8	183,00	1	080920041
8*	2	2,8	247,00	1	080920042
8*	3	2,8	326,00	1	080920043
8*	4	2,8	390,00	1	080920044
10*	1	4,25	266,00	1	080920051
10*	2	4,25	362,00	1	080920052
10*	3	4,25	454,00	1	080920053
10*	4	4,25	550,00	1	080920054
13*	1	7,5	426,00	1	080920131
13*	2	7,5	585,00	1	080920132
13	3	7,5	730,00	1	080920133
13	4	7,5	945,00	1	080920134
16*	1	11,2	850,00	1	080920161
16	2	11,2	1.130,00	1	080920162
16	3	11,2	1.380,00	1	080920163
16	4	11,2	1.630,00	1	080920164
20	2	17,0	2.050,00	1	080920172
20	3	17,0	2.500,00	1	080920173
20	4	17,0	2.940,00	1	080920174

* Caixa de madeira apropriada ao peso

Robur

Robur

8092SL

lingas de corrente,
2 secções, gancho com autobloqueio, grau 8

CE



EN 818-4

TECHNICAL DATA

- fator de segurança: 4
- etiqueta de identificação
- CERTIFICADOS ANEXOS
- Certificado do fabricante UNI EN818-4
- Declaração de Conformidade CE
- CERTIFICADOS DISPONÍVEIS
- Especificações técnicas

D mm	L m	WLL ton	€		
6*	1	1,6	188,00	1	080920201
6*	2	1,6	222,00	1	080920202
6*	3	1,6	265,00	1	080920203
6*	4	1,6	330,00	1	080920204
7*	1	2,12	228,00	1	080920221
7*	2	2,12	271,00	1	080920222
7*	3	2,12	352,00	1	080920223
7*	4	2,12	407,00	1	080920224
8*	1	2,8	236,00	1	080920241
8*	2	2,8	315,00	1	080920242
8*	3	2,8	380,00	1	080920243
8*	4	2,8	456,00	1	080920244
10*	1	4,25	372,00	1	080920251
10*	2	4,25	438,00	1	080920252
10*	3	4,25	535,00	1	080920253
10*	4	4,25	655,00	1	080920254
13*	1	7,5	655,00	1	080920331
13*	2	7,5	700,00	1	080920332
13*	3	7,5	955,00	1	080920333
13*	4	7,5	1.170,00	1	080920334
16*	1	11,2	1.260,00	1	080920361
16*	2	11,2	1.510,00	1	080920362
16*	3	11,2	1.760,00	1	080920363
16*	4	11,2	2.010,00	1	080920364
20	2	17,0	2.980,00	1	080920402
20	3	17,0	3.420,00	1	080920403
20	4	17,0	3.870,00	1	080920404

* Em estojo de plástico

8094

lingas de corrente, 4 secções
em estojo de plástico

Dispositivo de bloqueio automático e ganchos a pedido

CE



EN 818-4

CARACTERÍSTICAS TÉCNICAS

- fator de segurança: 4
- etiqueta de identificação
- CERTIFICADOS DISPONÍVEIS
- Certificado do fabricante UNI EN818-4
- Declaração de Conformidade CE
- CERTIFICADOS DISPONÍVEIS
- Especificações técnicas

D mm	L m	WLL ton	€		
6*	1	2,36	289,00	1	080940001
6*	2	2,36	390,00	1	080940002
6*	3	2,36	475,00	1	080940003
6*	4	2,36	560,00	1	080940004
7*	1	3,15	341,00	1	080940021
7*	2	3,15	450,00	1	080940022
7*	3	3,15	560,00	1	080940023
7*	4	3,15	665,00	1	080940024
8*	1	4,25	410,00	1	080940041
8*	2	4,25	535,00	1	080940042
8*	3	4,25	665,00	1	080940043
8	4	4,25	820,00	1	080940044
10*	1	6,7	545,00	1	080940051
10	2	6,7	745,00	1	080940052
10	3	6,7	955,00	1	080940053
10	4	6,7	1.150,00	1	080940054
13	1	11,2	900,00	1	080940131
13	2	11,2	1.230,00	1	080940132
13	3	11,2	1.560,00	1	080940133
13	4	11,2	1.880,00	1	080940134
16	1	17	1.770,00	1	080940161
16	2	17	2.270,00	1	080940162
16	3	17	2.770,00	1	080940163
16	4	17	3.260,00	1	080940164
20	2	26,5	3.920,00	1	080940172
20	3	26,5	4.810,00	1	080940173
20	4	26,5	5.700,00	1	080940174

* Caixa de madeira apropriada ao peso

Robur

Robur

8094SL

lingas de corrente,
4 secções, gancho com autobloqueio, grau 8

CE



EN 818-4

CARACTERÍSTICAS TÉCNICAS

- fator de segurança: 4
- etiqueta de identificação
- CERTIFICADOS ANEXOS
- Certificado do fabricante UNI EN818-4
- Declaração de Conformidade CE
- CERTIFICADOS DISPONÍVEIS
- Especificações técnicas

D mm	L m	WLL ton	€		
6*	1	2,36	388,00	1	080940201
6*	2	2,36	488,00	1	080940202
6*	3	2,36	575,00	1	080940203
6*	4	2,36	655,00	1	080940204
7*	1	3,15	473,00	1	080940221
7*	2	3,15	585,00	1	080940222
7*	3	3,15	690,00	1	080940223
7*	4	3,15	800,00	1	080940224
8*	1	4,25	520,00	1	080940241
8*	2	4,25	645,00	1	080940242
8*	3	4,25	795,00	1	080940243
8	4	4,25	955,00	1	080940244
10*	1	6,7	705,00	1	080940251
10	2	6,7	900,00	1	080940252
10	3	6,7	1.120,00	1	080940253
10	4	6,7	1.310,00	1	080940254
13	1	11,2	1.280,00	1	080940331
13	2	11,2	1.600,00	1	080940332
13	3	11,2	1.930,00	1	080940333
13	4	11,2	2.260,00	1	080940334
16	1	17	2.390,00	1	080940361
16	2	17	2.890,00	1	080940362
16	3	17	3.390,00	1	080940363
16	4	17	3.890,00	1	080940364
20	2	26,5	5.950,00	1	080940402
20	3	26,5	6.850,00	1	080940403
20	4	26,5	7.700,00	1	080940404

* Em estojo de plástico

8096

lingas de corrente, 1 secção,
com gancho Clevis,
em estojo de plástico

CE



EN 818-4

CARACTERÍSTICAS TÉCNICAS

- factor de segurança: 4
- etiqueta de identificação
- CERTIFICADOS DISPONÍVEIS
- Certificado do fabricante UNI EN818-4
- Declaração de Conformidade CE
- CERTIFICADOS DISPONÍVEIS
- Especificações técnicas

D mm	L m	WLL ton	€		
6*	1	1,12	112,00	1	080960001
6*	2	1,12	133,00	1	080960002
6*	3	1,12	154,00	1	080960003
6*	4	1,12	172,00	1	080960004
7*	1	1,5	124,00	1	080960021
7*	2	1,5	152,00	1	080960022
7*	3	1,5	173,00	1	080960023
7*	4	1,5	201,00	1	080960024
8*	1	2	137,00	1	080960041
8*	2	2	169,00	1	080960042
8*	3	2	201,00	1	080960043
8*	4	2	248,00	1	080960044
10*	1	3,15	190,00	1	080960051
10*	2	3,15	253,00	1	080960052
10*	3	3,15	301,00	1	080960053
10*	4	3,15	349,00	1	080960054
13*	1	5,3	312,00	1	080960131
13*	2	5,3	370,00	1	080960132
13*	3	5,3	449,00	1	080960133
13*	4	5,3	555,00	1	080960134
16*	1	8	620,00	1	080960161
16*	2	8	700,00	1	080960162
16*	3	8	825,00	1	080960163
16	4	8	980,00	1	080960164
20	1	12,5	1.180,00	1	080960171
20	2	12,5	1.410,00	1	080960172
20	3	12,5	1.630,00	1	080960173
20	4	12,5	1.850,00	1	080960174

* Embalagem de madeira adequada ao peso

8096SL

lingas de corrente,
1 secção, com ganchos de autobloqueio e
clevis, grau 8

CE



EN 818-4

CARACTERÍSTICAS TÉCNICAS

- fator de segurança: 4
- etiqueta de identificação
- CERTIFICADOS ANEXOS
- Certificado do fabricante UNI EN818-4
- Declaração de Conformidade CE
- CERTIFICADOS DISPONÍVEIS
- Especificações técnicas

D mm	L m	WLL ton	€		
6*	1	1,12	132,00	1	080960201
6*	2	1,12	154,00	1	080960202
6*	3	1,12	175,00	1	080960203
6*	4	1,12	196,00	1	080960204
7*	1	1,5	152,00	1	080960221
7*	2	1,5	179,00	1	080960222
7*	3	1,5	206,00	1	080960223
7*	4	1,5	234,00	1	080960224
8*	1	2	164,00	1	080960241
8*	2	2	196,00	1	080960242
8*	3	2	228,00	1	080960243
8*	4	2	276,00	1	080960244
10*	1	3,15	228,00	1	080960251
10*	2	3,15	291,00	1	080960252
10*	3	3,15	340,00	1	080960253
10*	4	3,15	387,00	1	080960254
13*	1	5,3	402,00	1	080960331
13*	2	5,3	483,00	1	080960332
13*	3	5,3	565,00	1	080960333
13*	4	5,3	645,00	1	080960334
16*	1	8	770,00	1	080960361
16*	2	8	890,00	1	080960362
16*	3	8	1.020,00	1	080960363
16	4	8	1.130,00	1	080960364
20	1	12,5	1.680,00	1	080960401
20	2	12,5	1.910,00	1	080960402
20	3	12,5	2.130,00	1	080960403
20	4	12,5	2.350,00	1	080960404

* Em estojo de plástico

8097

lingas de corrente, 2 secções,
com ganchos Clevis,
em estojo de plástico

CE



EN 818-4

CARACTERÍSTICAS TÉCNICAS

- factor de segurança: 4
- etiqueta de identificação
- CERTIFICADOS DISPONÍVEIS
- Certificado do fabricante UNI EN818-4
- Declaração de Conformidade CE
- CERTIFICADOS DISPONÍVEIS
- Especificações técnicas

D mm	L m	WLL ton	€		
6*	1	1,6	174,00	1	080970001
6*	2	1,6	208,00	1	080970002
6*	3	1,6	259,00	1	080970003
6*	4	1,6	308,00	1	080970004
7*	1	2,12	203,00	1	080970021
7*	2	2,12	247,00	1	080970022
7*	3	2,12	317,00	1	080970023
7*	4	2,12	371,00	1	080970024
8*	1	2,8	226,00	1	080970041
8*	2	2,8	292,00	1	080970042
8*	3	2,8	369,00	1	080970043
8*	4	2,8	433,00	1	080970044
10*	1	4,25	351,00	1	080970051
10*	2	4,25	447,00	1	080970052
10*	3	4,25	540,00	1	080970053
10*	4	4,25	635,00	1	080970054
13*	1	7,5	570,00	1	080970131
13*	2	7,5	735,00	1	080970132
13	3	7,5	880,00	1	080970133
13	4	7,5	1.040,00	1	080970134
16	1	11,2	1.100,00	1	080970161
16	2	11,2	1.350,00	1	080970162
16	3	11,2	1.600,00	1	080970163
16	4	11,2	1.850,00	1	080970164
20	2	17,0	2.500,00	1	080970172
20	3	17,0	2.940,00	1	080970173
20	4	17,0	3.390,00	1	080970174

* Embalagem de madeira adequada ao peso

Robur

8097SL

lingas de corrente,
2 secções, com ganchos de autobloqueio e
clevis, grau 8

CE



EN 818-4

CARACTERÍSTICAS TÉCNICAS

- fator de segurança: 4
 - etiqueta de identificação
- CERTIFICADOS ANEXOS**
- Certificado do fabricante UNI EN818-4
 - Declaração de Conformidade CE
- CERTIFICADOS DISPONÍVEIS**
- Especificações técnicas

D mm	L m	WLL ton	€		
6*	1	1,6	215,00	1	080970201
6*	2	1,6	249,00	1	080970202
6*	3	1,6	300,00	1	080970203
6*	4	1,6	357,00	1	080970204
7*	1	2,12	258,00	1	080970221
7*	2	2,12	317,00	1	080970222
7*	3	2,12	371,00	1	080970223
7*	4	2,12	426,00	1	080970224
8*	1	2,8	280,00	1	080970241
8*	2	2,8	346,00	1	080970242
8*	3	2,8	423,00	1	080970243
8*	4	2,8	487,00	1	080970244
10*	1	4,25	428,00	1	080970251
10*	2	4,25	525,00	1	080970252
10*	3	4,25	615,00	1	080970253
10*	4	4,25	710,00	1	080970254
13*	1	7,5	750,00	1	080970331
13*	2	7,5	915,00	1	080970332
13	3	7,5	1.110,00	1	080970333
13	4	7,5	1.220,00	1	080970334
16	1	11,2	1.480,00	1	080970361
16	2	11,2	1.730,00	1	080970362
16	3	11,2	1.970,00	1	080970363
16	4	11,2	2.150,00	1	080970364
20	2	17,0	3.500,00	1	080970402
20	3	17,0	3.940,00	1	080970403
20	4	17,0	4.390,00	1	080970404

* Em estojo de plástico

8098

lingas de corrente, 4 secções,
com ganchos Clevis,
em estojo de plástico

CE



EN 818-4

CARACTERÍSTICAS TÉCNICAS

- fator de segurança: 4
 - etiqueta de identificação
- CERTIFICADOS DISPONÍVEIS**
- Certificado do fabricante UNI EN818-4
 - Declaração de Conformidade CE
- CERTIFICADOS DISPONÍVEIS**
- Especificações técnicas

D mm	L m	WLL ton	€		
6*	1	2,36	360,00	1	080980001
6*	2	2,36	444,00	1	080980002
6*	3	2,36	525,00	1	080980003
6*	4	2,36	610,00	1	080980004
7*	1	3,15	424,00	1	080980021
7*	2	3,15	515,00	1	080980022
7*	3	3,15	620,00	1	080980023
7*	4	3,15	730,00	1	080980024
8*	1	4,25	471,00	1	080980041
8*	2	4,25	595,00	1	080980042
8*	3	4,25	725,00	1	080980043
8	4	4,25	880,00	1	080980044
10*	1	6,7	655,00	1	080980051
10	2	6,7	875,00	1	080980052
10	3	6,7	1.070,00	1	080980053
10	4	6,7	1.260,00	1	080980054
13	1	11,2	1.100,00	1	080980131
13	2	11,2	1.420,00	1	080980132
13	3	11,2	1.770,00	1	080980133
13	4	11,2	2.080,00	1	080980134
16	1	17	2.200,00	1	080980161
16	2	17	2.700,00	1	080980162
16	3	17	3.210,00	1	080980163
16	4	17	3.700,00	1	080980164
20	2	26,5	4.960,00	1	080980172
20	3	26,5	5.850,00	1	080980173
20	4	26,5	6.750,00	1	080980174

* Embalagem de madeira adequada ao peso

8098SL

lingas de corrente,
4 secções, ganchos clevis com autobloqueio,
grau 8

CE



EN 818-4

CARACTERÍSTICAS TÉCNICAS

- fator de segurança: 4
 - etiqueta de identificação
- CERTIFICADOS ANEXOS**
- Certificado do fabricante UNI EN818-4
 - Declaração de Conformidade CE
- CERTIFICADOS DISPONÍVEIS**
- Especificações técnicas

D mm	L m	WLL ton	€		
6*	1	2,36	441,00	1	080980201
6*	2	2,36	545,00	1	080980202
6*	3	2,36	605,00	1	080980203
6*	4	2,36	710,00	1	080980204
7*	1	3,15	535,00	1	080980221
7*	2	3,15	625,00	1	080980222
7*	3	3,15	730,00	1	080980223
7*	4	3,15	835,00	1	080980224
8*	1	4,25	605,00	1	080980241
8*	2	4,25	705,00	1	080980242
8	3	4,25	830,00	1	080980243
8*	4	4,25	990,00	1	080980244
10*	1	6,7	810,00	1	080980251
10	2	6,7	1.030,00	1	080980252
10	3	6,7	1.220,00	1	080980253
10	4	6,7	1.410,00	1	080980254
13	1	11,2	1.450,00	1	080980331
13	2	11,2	1.780,00	1	080980332
13	3	11,2	2.130,00	1	080980333
13	4	11,2	2.440,00	1	080980334
16	1	17	2.830,00	1	080980361
16	2	17	3.330,00	1	080980362
16	3	17	3.830,00	1	080980363
16	4	17	4.300,00	1	080980364
20	2	26,5	7.000,00	1	080980402
20	3	26,5	7.900,00	1	080980403
20	4	26,5	8.750,00	1	080980404

* Em estojo de plástico

8100

correntes de elevação,
liga de aço muito resistente

CE

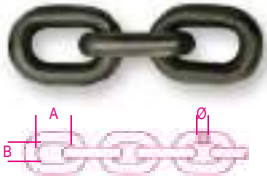

EN 818-2

CARACTERÍSTICAS TÉCNICAS

- fator de segurança: 4
- tratamento a quente: reforçado e temperado
- código de localização

TESTES LABORATORIAIS

- análise química
- análise metalográfica
- teste de elasticidade

CERTIFICADOS DISPONÍVEIS

- Especificações de produto
- Relatório de Teste UNI EN10204 tipo 2.2
- Certificado do Fabricante EN818-2
- Declaração de Conformidade CE

WLL kg	Ø mm	A mm	B min mm	€/m		
1120	6	18	7,8	21,30	1	081000011
1500	7	21	11,0	27,50	1	081000016
2000	8	24	12,0	32,00	1	081000020
3150	10	30	14,5	48,00	1	081000032
5300	13	39	20,0	82,00	1	081000053
8000	16	48	20,8	125,00	1	081000080
12500	20	60	26,0	223,00	1	081000125

8085R

anéis de elevação,
em liga de aço de alta resistência

WLL refere-se à utilização com eslingas de 1 corrente

CE



EN 1677-4

CARACTERÍSTICAS TÉCNICAS

- fator de segurança: 4
- tratamento térmico: endurecido e temperado
- código de identificação

TESTES LABORATORIAIS

- análise química, análise metalográfica
- ensaio de carga (WLL x 2.5)
- ensaio de tensão

- teste de fadiga (min. 2,000 ciclos)

CERTIFICADOS DISPONÍVEIS

- Especificações técnicas
- Relatório de teste UNI EN10204 tipo 2.2
- Certificado de inspeção UNI EN10204 tipo 3.1
- Declaração de Conformidade CE

WLL kg	Ø mm	A mm	B mm	€		
* 1600	7	110	60	11,30	1	080850215
2120	8	110	60	16,00	1	080850220
3150	10	135	75	22,60	1	080850232
5300	13	160	90	39,50	1	080850253
8000	16	180	100	79,50	1	080850280
11200	19	200	110	129,00	1	080850311
16000	20	260	140	212,00	1	080850316
17000	22	300	160	301,00	1	080850317

8086

anéis tripos em liga de aço,
alta resistência

A carga de trabalho WLL é relativa à utilização
com anéis a três ou quatro braços e ângulo β inferior a 45°

CE



EN 1677-4

CARACTERÍSTICAS TÉCNICAS

- fator de segurança: 4
- tratamento térmico: endurecido e temperado
- código de identificação

TESTES LABORATORIAIS

- análise química, análise metalográfica
- ensaio de carga (WLL x 2.5)
- ensaio de tracção

- teste de fadiga (min. 20,000 ciclos)

CERTIFICADOS DISPONÍVEIS

- Especificações técnicas
- Relatório de ensaio UNI EN10204 tipo 2.2
- Certificado de inspeção UNI EN10204 tipo 3.1
- Declaração de conformidade CE

WLL kg	Ø mm	B mm	C mm	€		
* 3150	7	135	75	73,00	1	080860021
4250	8	160	90	113,00	1	080860042
6700	10	180	100	145,00	1	080860067
11200	13	200	110	235,00	1	080860100
17000	16	260	140	343,00	1	080860117
21200	18	340	180	615,00	1	080860121
26500	20	350	190	870,00	1	080860126

* Acoplado a corrente Ø 7 mm, WLL = 3150 Kg

8090R

malha de junção em liga de aço,
alta resistência

CE

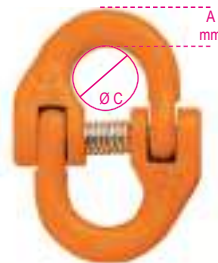

EN 1677-1

CARACTERÍSTICAS TÉCNICAS

- fator de segurança: 4
- tratamento térmico: endurecido e temperado
- código de identificação

TESTES LABORATORIAIS

- análise química, análise metalográfica
- ensaio de carga (WLL x 2.5)
- ensaio de tracção

- teste de fadiga (min. 20,000 ciclos)

CERTIFICADOS DISPONÍVEIS

- Especificações técnicas
- Relatório de ensaio UNI EN10204 tipo 2.2
- Certificado de inspeção UNI EN10204 tipo 3.1
- Declaração de Conformidade CE

WLL kg	Ø mm	Ø C max	A mm	€		
1120	6	13	7,5	9,60	1	080900111
1500	7	18	9	12,40	1	080900115
2000	8	18	11	15,20	1	080900120
3150	10	22	13,0	18,50	1	080900131
5300	13	30	16	33,50	1	080900153
8000	16	32	22	73,00	1	080900180
12500	20	40	25	167,00	1	080900312

8060R

ganchos Clevis para elevação,
em liga de aço de elevada resistência

CE



EN 1677-2

CARACTERÍSTICAS TÉCNICAS

- fator de segurança: 4
- tratamento a quente: endurecimento e reforço
- código de detecção no pino, fecho de segurança, estrutura

TESTES LABORATORIAIS

- análise química, análise metalográfica
- teste de elasticidade
- teste de fadiga (min. 20,000 ciclos)

- teste prova de carga (2,5 x WLL)

CERTIFICADOS DISPONÍVEIS

- Especificações do Produto
- Relatório de Teste UNI EN10204 tipo 2.2
- Certificado de Inspeção UNI EN10204 tipo 3.1
- Declaração de Conformidade CE

WLL kg	Ø mm	C mm	€		
1120	6	19	18,00	1	080600111
1500	7	19	19,30	1	080600115
2000	8	21	20,10	1	080600120
3150	10	27	34,50	1	080600132
5300	13	35	55,50	1	080600153
8000	16	48	176,00	1	080600180
12500	20	54	312,00	1	080600225

8058R

ganchos de elevação self-locking,
tipo Clevis,
em liga de aço de alta resistência

CE



EN 1677-3

CARACTERÍSTICAS TÉCNICAS

- fator de segurança: 4
- tratamento térmico: endurecido e temperado
- código de identificação

TESTES LABORATORIAIS

- análise química, análise metalográfica
- ensaio de tracção
- teste de fadiga (min. 20,000 ciclos)

- teste prova de carga (100% do lote)

CERTIFICADOS DISPONÍVEIS

- Especificações técnicas
- Relatório de ensaio UNI EN10204 tipo 2.2
- Certificado de inspeção UNI EN10204 tipo 3.1
- Declaração de Conformidade CE

WLL kg	Ø mm	J min mm	€		
1120	6	28	38,50	1	080580112
2000	7-8	34	47,00	1	080580120
3150	10	44	73,00	1	080580132
5300	13	52	145,00	1	080580153
8000	16	67	326,00	1	080580180
12500	20	77	815,00	1	080580225

8061R

ganchos Clevis
com bloqueio de segurança,
em liga de aço de alta resistência

CE



EN 1677-1

CARACTERÍSTICAS TÉCNICAS

- factor de segurança: 4
- tratamento térmico: endurecido e temperado
- código de identificação
- TESTES LABORATORIAIS
- análise química, análise metalográfica
- ensaio de tracção
- teste de fadiga (min. 20,000 ciclos)
- teste prova de carga (100% do lote)
- CERTIFICADOS DISPONÍVEIS
- Especificações técnicas
- Relatório de ensaio UNI EN10204 tipo 2.2
- Certificado de inspecção UNI EN10204 tipo 3.1
- Declaração de Conformidade CE

WLL kg	Ø mm	E mm	€	📄	📄
1120	6	8	13,40	1	080610211
2000	7-8	11	15,30	1	080610220
3150	10	13	28,00	1	080610231
5300	13	17	49,00	1	080610253
8000	16	20	110,00	1	080610280
12500	20	24	262,00	1	080610312

8052

ganchos de elevação tipo americano
de alta resistência em liga de aço

CE



EN 1677-2

CARACTERÍSTICAS TÉCNICAS

- factor de segurança: 4
- tratamento a quente: endurecimento e reforço
- código de detecção
- TESTES LABORATORIAIS
- análise química, análise metalográfica
- teste de elasticidade
- teste de fadiga (min. 20,000 ciclos)
- teste prova de carga (2 x WLL)
- CERTIFICADOS DISPONÍVEIS
- Especificações Técnicas
- Relatório de Teste UNI EN10204 tipo 2.2
- Certificado de Inspeção UNI EN10204 tipo 3.1
- Declaração de Conformidade CE

WLL kg	C mm	€	📄	📄
8052 0,8	800 18	6,90	1	080520008
8052 1,12	1120 22,5	9,20	1	080520011
8052 2	2000 30	19,40	1	080520020
8052 3,15	3150 36	29,50	1	080520031
8052 4	4000 39,5	38,50	1	080520040

8055S 5,4	5400 32	75,00	1	080550145
8055S 8,0	8000 43	131,00	1	080550170
8055S 11,5	11500 53	260,00	1	080550215
8055S 16,0	16000 58	349,00	1	080550260
8055S 22,0	22000 78	820,00	1	080550320

8057R

ganchos de elevação self-locking,
com olhal,
em liga de aço de alta resistência

CE



EN 1677-3

CARACTERÍSTICAS TÉCNICAS

- factor de segurança: 4
- tratamento térmico: endurecido e temperado
- código de identificação
- TESTES LABORATORIAIS
- análise química, análise metalográfica
- ensaio de tracção
- teste de fadiga (min. 20,000 ciclos)
- teste prova de carga (100% do lote)
- CERTIFICADOS DISPONÍVEIS
- Especificações técnicas
- Relatório de ensaio UNI EN10204 tipo 2.2
- Certificado de inspecção UNI EN10204 tipo 3.1
- Declaração de Conformidade CE

WLL kg	Ø mm	J min mm	ØB mm	€	📄	📄
1120	6	28	22	31,00	1	080570112
2000	7-8	34	25	37,00	1	080570120
3150	10	44	32	66,50	1	080570132
5300	13	54	40	231,00	1	080570153

8063

ganchos giratórios
em liga de aço de alta resistência

CE



EN 1677-1

CARACTERÍSTICAS TÉCNICAS

- factor de segurança: 4
- tratamento térmico: endurecido e temperado
- código de identificação
- TESTES LABORATORIAIS
- análise química, análise metalográfica
- ensaio de tracção
- teste de fadiga (min. 20,000 ciclos)
- teste prova de carga (100% do lote)
- CERTIFICADOS DISPONÍVEIS
- Especificações técnicas
- Relatório de ensaio UNI EN10204 tipo 2.2
- Certificado de inspecção UNI EN10204 tipo 3.1
- Declaração de Conformidade CE

WLL kg	A mm	E mm	€	📄	📄
800	32	20,5	15,30	1	080630008
1120	38	20,5	19,30	1	080630011
2000	44,5	22	23,50	1	080630020
3150	44,5	27	29,00	1	080630031

8063SL

ganchos de elevação giratórios com bloqueio
automático
(não sob carga)
liga de aço de elevada resistência
grau 8

CE



EN 1677-1

Características técnicas:

- factor de segurança: 4
- tratamento térmico: endurecido e temperado
- código de identificação
- TESTES LABORATORIAIS
- análise química, análise metalográfica
- ensaio de tensão
- teste de fadiga (min. 20.000 ciclos)
- teste de carga (100% da produção)
- CERTIFICADOS DISPONÍVEIS
- Especificações técnicas
- Relatório de teste UNI EN10204 tipo 2.2
- Certificado de inspeção UNI EN10204 tipo 3.1
- Declaração de Conformidade CE

WLL kg	Ø mm	B mm	J mm	€	📄	📄
1120	6	32	45	40,00	1	080630311
2000	8	35	59	56,00	1	080630320
3150	10	42	54	97,00	1	080630331
5300	13	49	83	148,00	1	080630353

8064S

ganchos giratórios em aço carbono,
alta resistência

CE



EN 1677-5

CARACTERÍSTICAS TÉCNICAS

- factor de segurança: 5
- tratamento térmico: endurecido e temperado
- código de identificação
- TESTES LABORATORIAIS
- análise química, análise metalográfica
- ensaio de carga (WLL x 2.5)
- ensaio de tracção
- teste de fadiga (min. 20,000 ciclos)
- CERTIFICADOS DISPONÍVEIS
- Especificações técnicas
- Relatório de ensaio UNI EN10204 tipo 2.2
- Certificado de inspeção UNI EN10204 tipo 3.1
- Declaração de Conformidade CE

WLL kg	B mm	C mm	€	📄	📄
800	31	20	37,50	1	080640107
1000	40	22	52,50	1	080640110
1600	47	23	69,00	1	080640115
2000	47	27	75,50	1	080640120
3200	64	35	132,00	1	080640130
5000	77	43	240,00	1	080640150
7500	90	53	350,00	1	080640175
10000	96	58	585,00	1	080640199

8065SC

ganchos de elevação giratórios,
aço carbono, elevada resistência

CE

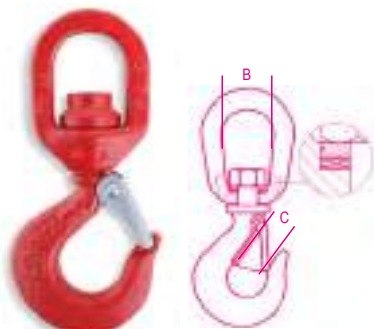

EN 1677-5

CARACTERÍSTICAS TÉCNICAS

- fator de segurança: 5
- tratamento térmico: endurecido e temperado
- código de identificação

TESTES LABORATORIAIS

- análise química, análise metalográfica
- ensaio de carga (WLL x 2.5)
- ensaio de tracção
- teste de fadiga (min. 20,000 ciclos)

CERTIFICADOS DISPONÍVEIS

- Especificações técnicas
- Relatório de ensaio UNI EN10204 tipo 2.2
- Certificado de inspecção UNI EN10204 tipo 3.1
- Declaração de Conformidade CE

WLL kg	B mm	C mm	€	📦	🚚
800	38	20	75,00	1	080650107
1000	38	22	81,50	1	080650110
1600	47	23	101,00	1	080650115
2000	47	27	115,00	1	080650120
3200	54	35	203,00	1	080650130
5000	72	43	300,00	1	080650150
7500	82	53	510,00	1	080650175

8062

gancho corrediço em liga de aço

CE



CARACTERÍSTICAS TÉCNICAS

- fator de segurança: 5
- tratamento térmico: endurecido e temperado
- código de identificação

TESTES LABORATORIAIS

- análise química, análise metalográfica
- ensaio de carga (WLL x 2.5)
- ensaio de tracção

CERTIFICADOS DISPONÍVEIS

- Especificações técnicas
- Relatório de ensaio UNI EN10204 tipo 2.2
- Certificado de inspecção UNI EN10204 tipo 3.1
- Declaração de Conformidade CE

WLL kg	C mm	F mm	€	📦	🚚
1500	19	10-13	45,00	1	080620013
2000	21	16	64,00	1	080620016
3000	26	18	107,00	1	080620018

8051S

ganchos com olhal em aço carbono,
zincados

CE



CARACTERÍSTICAS TÉCNICAS

- fator de segurança: 4
- tratamento térmico: normalizador
- código de identificação

TESTES LABORATORIAIS

- análise química
 - análise metalográfica
 - ensaio de tracção
- ### CERTIFICADOS DISPONÍVEIS
- Especificações técnicas
 - Relatório de ensaio UNI EN10204 tipo 2.2
 - Certificado de inspecção UNI EN10204 tipo 3.1
 - Declaração de Conformidade CE

WLL kg	C mm	F mm	€	📦	🚚
250	14	12	3,30	10	080510202
500	18	16,5	7,30	5	080510205

Embalagens especiais com blister



WLL kg	📦	€	📦	🚚
250	1	4,65	1	080519202
500	1	9,10	1	080519205

8134

ímã de elevação

CE



EN13155

Características técnicas:

- Fator de segurança: 3
- Etiqueta de identificação

Certificados disponíveis:

- Certificado do Fabricante
- Declaração de Conformidade com Diretiva de Máquinas 2006/42/EC
- Relatório de Teste UNI EN10204 tipo 2.2
- Manual de funcionamento e manutenção

WLL kg	A mm	B mm	C mm	€	📦	🚚
100	70	64	92	480,00	1	081340010
300	96	88	165	845,00	1	081340030
600	120	118	236	1.570,00	1	081340060
1000	168	168	264	2.590,00	1	081340100

8135

gancho de elevação em aço
com olhais articulados

CE



EN13155

CARACTERÍSTICAS TÉCNICAS

- Fator de segurança: 3
 - Placa de identificação do número de série
- ### CERTIFICADOS DISPONÍVEIS
- Certificado do Fabricante
 - Declaração de Conformidade CE
 - Relatório de teste UNI EN10204 tipo 2.2
 - Especificações técnicas do produto

WLL t	A mm	E mm	📦	€	📦	🚚
0,75	0-15	2	2	138,00	1	081350005
1,0	0-20	5	5	186,00	1	081350010
2,0	0-25	8	8	277,00	1	081350020
3,0	0-30	15	15	469,00	1	081350032
5,0	0-50	23	23	660,00	1	081350050

8143

diferencial de corrente manual

CE



EN13157

Certificado TUV

WLL t	📦	esforço / effort L m	kg	€	📦	🚚
0,5	3	27	223,00	1	081430005	
1	3	44	262,00	1	081430010	
1,5	3	44	347,00	1	081430015	
2	3	44	381,00	1	081430020	
3	3	45	491,00	1	081430030	
5	3	47	730,00	1	081430050	

0,5	6	27	333,00	1	081430105
1	6	44	374,00	1	081430110
1,5	6	44	486,00	1	081430115
2	6	44	530,00	1	081430120
3	6	45	755,00	1	081430130
5	6	47	1.070,00	1	081430150

8146

diferencial de alavanca

CE



EN13157
Certificado TUV

WLL t	L m	sforzo / effort kg	€		
0,75	1,5	21*	271,00	1	081460008
1,5	1,5	41*	386,00	1	081460015
3,0	1,5	41	520,00	1	081460030
6,0	1,5	46	840,00	1	081460060

0,75	3,0	21*	304,00	1	081460108
1,5	3,0	41*	429,00	1	081460115
3,0	3,0	41	595,00	1	081460130
6,0	3,0	46	1.010,00	1	081460160

H= distância mínima entre ganchos
(* equipadas com sistema de protecao de sobrecarga)

Robur

8146C

diferencial de alavanca, compacto

CE



EN13157
Certificado TUV

WLL t	L m	sforzo / effort kg	€		
0,25	1,5	20,7	250,00	1	081460002

8147C

trolley de corrente
para guincho manual

adequado para vigas estruturais (INP, IPB, IPE, HEA, HEB etc.)

CE



EN 13157

Características técnicas:
• Fator de segurança: 4
• Etiqueta de identificação

Certificados disponíveis:
• Certificado do Fabricante
• Declaração de Conformidade CE
• Relatório de teste UNI EN10204 tipo 2.2
• Especificações técnicas do produto

WLL t	L min mm	L max mm	Lm	€		
1,0	58	220	3	278,00	1	081470510
2,0	66	220	3	355,00	1	081470520
3,0	74	220	3	545,00	1	081470530
5,0	90	220	3	750,00	1	081470550

Artigo fornecido desmontado: deve ser montado antes da utilização de acordo com o manual de instruções.

8147S

trolley para guincho manual

adequado para vigas estruturais (INP, IPB, IPE, HEA, HEB etc.)

CE



EN 13157

Características técnicas:
• Fator de segurança: 4
• Etiqueta de identificação

Certificados disponíveis:
• Certificado do Fabricante
• Declaração de Conformidade CE
• Relatório de teste UNI EN10204 tipo 2.2
• Especificações técnicas do produto

WLL t	L min mm	L max mm	øF mm	€		
0,5	50	220	25	179,00	1	081470005
1,0	58	220	30	229,00	1	081470010
2,0	66	220	40	291,00	1	081470020

Artigo fornecido desmontado: deve ser montado antes da utilização de acordo com o manual de instruções.

8147P

grampo para viga
para guincho manual

adequado para vigas estruturais (INP, IPB, IPE, HEA, HEB etc.)

CE

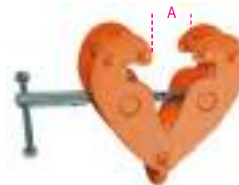

Características técnicas:
• Fator de segurança: 4
• Etiqueta de identificação

Certificados disponíveis:
• Certificado do Fabricante
• Declaração de Conformidade CE
• Relatório de teste UNI EN10204 tipo 2.2
• Especificações técnicas do produto

WLL t	A min mm	A max mm	€		
1,0	90	180	118,00	1	081470210
2,0	90	190	143,00	1	081470220
3,0	85	280	241,00	1	081470230
5,0	85	280	351,00	1	081470250

Robur

8148

guincho manual,
corpo em liga de alumínio,
completo com alavanca de trabalho, corda e
gancho

Leve e portátil, o guincho manual Robur está em conformidade com a norma EN 13157, é fabricado com materiais de alta qualidade e é adequado para elevar, içar, tensionar e fixar cargas em todas as direções através da alavanca.

Habitualmente ligado a um ponto amarração, permite um posicionamento muito preciso da carga e garante um trabalho seguro na horizontal, vertical e com inclinação. Fácil instalação e utilização graças ao seu design compacto e prático.

O guincho manual Robur manual possibilita a utilização de cordas de qualquer comprimento e a sua capacidade pode ser aumentada por um fator de 2, 3, 4 ou mais – mediante inspeção da sua estrutura e utilizando rolos de condução e ganchos com blocos em conformidade com a norma de referência.

CE



EN 13157

• Fator de segurança: 4:1

WLL t	L m	A mm	ø f mm	€		
0,8	20	426	8,3	398,00	1	081480008
1,6	20	545	11	625,00	1	081480016
3,2	20	660	16	1.030,00	1	081480032

0,8	30	426	8,3	444,00	1	081480108
1,6	30	545	11	695,00	1	081480116
3,2	30	660	16	1.160,00	1	081480132

0,8	50	426	8,3	540,00	1	081480308
1,6	50	545	11	805,00	1	081480316
3,2	50	660	16	1.400,00	1	081480332

8148F

cabo em aço galvanizado com cruzeta com gancho de elevada resistência

CE



WLL t	L m	ØF mm	€		
0,8	20	8,3	109,00	1	081480520
1,6	20	11	172,00	1	081480521
3,2	20	16	333,00	1	081480523

0,8	30	8,3	154,00	1	081480530
1,6	30	11	240,00	1	081480531
3,2	30	16	460,00	1	081480533

0,8	50	8,3	246,00	1	081480550
1,6	50	11	350,00	1	081480551
3,2	50	16	705,00	1	081480553

8120

correntes de elevação
para ligações estáticas,
galvanizadas



CARACTERÍSTICAS TÉCNICAS

- fator de segurança: 4
- CERTIFICADOS DISPONÍVEIS
- Especificações técnicas
- Relatório de ensaio UNI EN10204 tipo 2.2

Ø mm	nr	WFL kg	m	€		
1,5	10	8	150	207,00	1	081200015
1,6	12	15	150	216,00	1	081200016
2,2	14	25	75	126,00	1	081200022
2,7	16	40	75	156,00	1	081200027
3,0	17	55	75	173,00	1	081200030
3,4	18	100	60	176,00	1	081200034
3,8	19	110	50	170,00	1	081200038
4,4	20	200	40	157,00	1	081200044
4,8	21	250	30	150,00	1	081200048
5,5	22	300	25	150,00	1	081200055
5,8	23	310	25	170,00	1	081200058
6,5	24	400	25	193,00	1	081200065
7,0	25	450	25	235,00	1	081200070
7,5	26	550	20	209,00	1	081200075
* 8,0	27	600	25	303,00	1	081200080
* 9,0	28	800	25	381,00	1	081200090
* 10,0	30	1000	20	385,00	1	081200100
* 12,0	32	1400	15	408,00	1	081200120

Atenção: produto NÃO concebido para elevação

(* disponível em ROLOS

8120B

Correntes de elevação para ligações estáticas, galvanizadas



CARACTERÍSTICAS TÉCNICAS

- fator de segurança: 4
- CERTIFICADOS DISPONÍVEIS
- Especificações técnicas
- Relatório de ensaio UNI EN10204 tipo 2.2

Ø mm	nr	WFL kg	m	€		
1,5	10	8	200	258,00	1	081200315
1,6	12	15	200	272,00	1	081200316
2,2	14	25	100	161,00	1	081200322
2,7	16	40	100	206,00	1	081200327
3,0	17	55	75	172,00	1	081200330
3,4	18	100	100	273,00	1	081200334
3,8	19	110	75	243,00	1	081200338
4,4	20	200	50	188,00	1	081200344
4,8	21	250	50	243,00	1	081200348
5,5	22	300	40	233,00	1	081200355
5,8	23	310	30	199,00	1	081200358
6,5	24	400	30	227,00	1	081200365
7,0	25	450	25	229,00	1	081200370
7,5	26	550	25	252,00	1	081200375
8,0	27	600	15	195,00	1	081200380
9,0	28	800	15	230,00	1	081200390
10,0	30	1000	10	188,00	1	081200400
12,0	32	1400	8	218,00	1	081200420

Atenção: produto NÃO concebido para elevação

8121MZC

corrente
para uniões estáticas,
galvanizada a quente



CERTIFICADOS DISPONÍVEIS

- Especificações técnicas
- Relatório de ensaio UNI EN10204 tipo 2.2

Ø mm	nr	WFL kg	m	€		
6,0	23	310	50	371,00	1	081210306
8,0	27	600	50	635,00	1	081210308
10,0	30	1000	50	1.010,00	1	081210310
12,0	32	1400	50	1.440,00	1	081210312
14,0	34	1800	50	2.030,00	1	081210314

8120D

correntes calibradas DIN766

galvanização eletrolítica

disponíveis em qualquer comprimento a pedido (>30m)



Características técnicas:

- fator de segurança: 4
- CERTIFICADOS DISPONÍVEIS
- Especificações técnicas
- Relatório de teste UNI EN10204 tipo 2.2

Ø mm	P mm	WFL kg	m	€		
4	16	200	30	130,00	1	081200640
5	18,5	320	30	183,00	1	081200650
6	18,5	400	30	277,00	1	081200660
7	22	630	30	332,00	1	081200670
8	24	800	30	439,00	1	081200680
10	28	1250	30	670,00	1	081200700

correntes calibradas DIN766

galvanização a quente

Ø mm	P mm	WFL kg	m	€		
4	16	200	30	161,00	1	081200840
5	18,5	320	30	220,00	1	081200850
6	18,5	400	30	327,00	1	081200860
7	22	630	30	384,00	1	081200870
8	24	800	30	510,00	1	081200880
10	28	1250	30	775,00	1	081200900

8129

corrente de barreira,
em metal galvanizado pintado de vermelho e
branco



Ø mm	m	€	📦	🚚
5	30	273,00	1	081290050

Atenção: NÃO adequada para elevar ou ancorar

8130

correntes antirroubo, em liga de aço,
endurecido, temperado,
galvanizado



Ø mm	L mm	€	📦	🚚
6	800	16,50	1	081300068
8	1000	35,50	1	081300081
8	1200	40,50	1	081300082
10	1500	62,00	1	081300105

8074

mosquetão, zincado



DIN 5299 tipo C

CARACTERÍSTICAS TÉCNICAS

- fator de segurança: 4
- CERTIFICADOS DISPONÍVEIS
- Especificações técnicas
- Relatório de ensaio UNI EN10204 tipo 2.2

DxL mm	A mm	WFL kg	€	📦	🚚
* 4x40	6	20	0,67	100	080740040
5x50	7	30	0,68	100	080740050
6x60	8	40	0,75	100	080740060
7x70	9	60	0,96	50	080740070
8x80	11	75	1,16	50	080740080
9x90	12	100	1,58	25	080740090
10x100	13	120	2,14	25	080740100
11x120	16	140	2,89	20	080740101
12x140	22	140	4,05	15	080740102
13x160	24	200	5,60	10	080740103
* 14x180	32	250	11,70	5	080740104

packs especiais



DxL mm	A mm	📦	€	📦	🚚
6x60	8	50	42,50	1	080740760
7x70	9	25	27,50	1	080740770
8x80	11	25	32,50	1	080740780
9x90	12	15	27,00	1	080740790
10x100	13	15	36,50	1	080740800
11x120	16	10	32,50	1	080740801
12x140	22	10	45,50	1	080740802

8074A

ganchos articulados, zincado



DIN 5299 tipo A

CARACTERÍSTICAS TÉCNICAS

- fator de segurança: 4
- CERTIFICADOS DISPONÍVEIS
- Especificações técnicas
- Relatório de ensaio UNI EN10204 tipo 2.2

øAxL mm	D mm	WFL kg	€	📦	🚚
5x50	7,4	30	0,92	50	080740405
6x60	8,7	40	1,06	50	080740406
8x80	10,5	75	1,44	25	080740408
10x100	13,3	120	2,55	10	080740410

8074G

mosquetão com porca, zincado



CARACTERÍSTICAS TÉCNICAS

- fator de segurança: 4
- CERTIFICADOS DISPONÍVEIS
- Especificações técnicas
- Relatório de ensaio UNI EN10204 tipo 2.2

øAxL mm	D mm	WFL kg	€	📦	🚚
5x50	7,5	30	1,03	50	080740305
6x60	8,5	40	1,18	50	080740306
8x80	10,3	75	1,58	25	080740308
10x100	10,6	120	2,67	10	080740310

8080

elo de ligação rápida, zincado

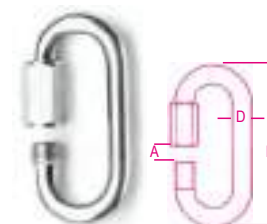

CARACTERÍSTICAS TÉCNICAS

- fator de segurança: 4
- CERTIFICADOS DISPONÍVEIS
- Especificações técnicas
- Relatório de ensaio UNI EN10204 tipo 2.2

DxL mm	A mm	WFL kg	€	📦	🚚
3,5x36	5	20	0,54	100	080800003
4x40	6	30	0,58	100	080800004
5x49	6	50	0,71	100	080800005
6x57	8	60	0,89	100	080800006
7x66	8	100	1,16	50	080800007
8x74	11	140	1,38	50	080800008
9x80	11	160	1,99	25	080800009
10x89	11	220	2,34	25	080800010
12x105	15	300	4,05	20	080800012
14x122	16,5	400	8,80	3	080800014

8080FM

elo de ligação,
galvanização



Características técnicas:

- fator de segurança: 4
- CERTIFICADOS DISPONÍVEIS
- Especificações técnicas
- Relatório de teste UNI EN10204 tipo 2.2

M	ød mm	b mm	t mm	€	📦	🚚
4	3,8	8,6	21,5	0,43	100	080800204
5	4,7	11,1	25,8	0,70	50	080800205
6	5,3	13,8	32,0	1,36	30	080800206
7	6,5	16,8	37,0	1,62	10	080800207
8	8,0	18,0	38,0	2,39	10	080800208

8082

anéis
aço galvanizado

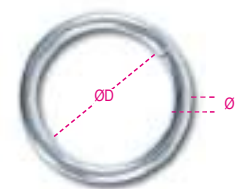

Ø mm	ØD mm	WFL kg	€	📦	🚚
4	20	75	0,42	50	080820004
5	30	125	0,54	20	080820005
6	40	185	0,89	10	080820006
7	50	265	1,38	5	080820007
8	60	350	1,85	5	080820008

8083

ganchos em S
aço galvanizado



Ø mm	L mm	WFL kg	€		
3	33	4	0,08	100	080830003
4	40	5	0,12	60	080830004
5	47	12	0,23	50	080830005
6	59	18	0,43	30	080830006
8	79	33	1,07	10	080830008

8114

destorcedores,
galvanizados

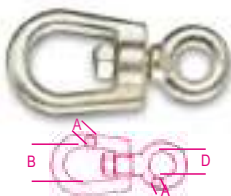

CARACTERÍSTICAS TÉCNICAS

- fator de segurança: 4
- código de identificação

TESTES LABORATORIAIS

- ensaio de tração

CERTIFICADOS DISPONÍVEIS

- Especificações técnicas
- Relatório de ensaio UNI EN10204 tipo 2.2
- Certificado de inspeção UNI EN10204 tipo 3.1

A mm	B mm	D mm	WFL kg	€		
8	30	16	250	4,40	10	081140008
10	38	18	300	8,20	10	081140010
12	42	20	650	11,80	5	081140012
14	48	22	820	18,30	5	081140014
16	57	24	1000	25,00	3	081140016
18	64	26	1600	30,00	3	081140018
20	72	30	2000	42,00	1	081140020
22	80	34	2500	59,00	1	081140022

8116

destorcedores,
galvanizados

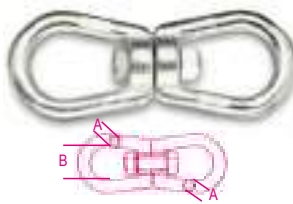

CARACTERÍSTICAS TÉCNICAS

- fator de segurança: 4
- código de identificação

TESTES LABORATORIAIS

- ensaio de tração

CERTIFICADOS DISPONÍVEIS

- Especificações técnicas
- Relatório de ensaio UNI EN10204 tipo 2.2
- Certificado de inspeção UNI EN10204 tipo 3.1

A mm	B mm	WFL kg	€		
6	23	140	4,70	10	081160006
8	30	250	5,90	10	081160008
10	38	300	10,80	5	081160010
12	42	650	17,70	5	081160012
14	48	820	26,50	3	081160014
16	57	1000	33,00	3	081160016
18	64	1600	40,00	1	081160018
20	72	2000	57,00	1	081160020
22	80	2500	88,00	1	081160022

8317SZ

cerra-cabos simples
galvanizado

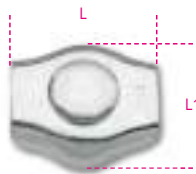

CERTIFICADOS DISPONÍVEIS

- Relatório de ensaio UNI EN10204 tipo 2.2

Ø mm	L mm	L1 mm	€		
2	15	14	0,26	100	083170102
3	18	16	0,27	100	083170103
4	20	19	0,38	100	083170104
5	24	23	0,44	50	083170105
6	30	27	0,52	30	083170106
8	36	34	1,00	20	083170108
10	42	37	1,51	10	083170110

8317DZ

cerra-cabos duplo
galvanizado



CERTIFICADOS DISPONÍVEIS

- Relatório de ensaio UNI EN10204 tipo 2.2

Ø mm	L mm	L1 mm	€		
2	30	14	0,34	50	083170002
3	35	15	0,47	50	083170003
4	40	18	0,54	50	083170004
5	50	21	0,69	25	083170005
6	60	25	0,92	20	083170006
8	76	33	1,99	10	083170008
10	95	37	3,00	10	083170010

8381SL

colares para sustentar tubulações
série leveira, zincados

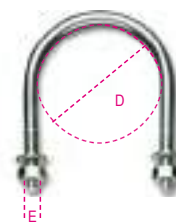

CERTIFICADOS DISPONÍVEIS

- Especificações técnicas
- Relatório de ensaio UNI EN10204 tipo 2.2

D mm	D gas	E mm	€		
11	1/8"	M6	0,54	100	083810201
14	1/4"	M6	0,58	100	083810202
18	3/8"	M6	0,58	100	083810203
22	1/2"	M6	0,67	100	083810204
27	3/4"	M6	0,67	100	083810205
34	1"	M6	0,73	100	083810206
43	1 1/4"	M6	0,73	100	083810207
49	1 1/2"	M8	1,31	50	083810208
61	2"	M8	1,38	50	083810209
77	2 1/2"	M8	1,64	25	083810210
89	3"	M8	1,76	25	083810211
102	3 1/2"	M8	1,99	25	083810212
115	4"	M8	2,20	25	083810213
140	5"	M8	4,85	25	083810215
168	6"	M10	5,30	25	083810218
220	8"	M10	10,80	10	083810220

8381SP

colares para sustentar tubulações
série pesada, zincados



CERTIFICADOS DISPONÍVEIS

- Especificações técnicas
- Relatório de ensaio UNI EN10204 tipo 2.2

D mm	D gas	E mm	€		
22	1/2"	M8	0,96	100	083810301
27	3/4"	M8	1,05	100	083810302
34	1"	M8	1,13	100	083810303
43	1 1/4"	M8	1,22	100	083810304
49	1 1/2"	M10	2,07	25	083810305
61	2"	M10	2,26	25	083810306
77	2 1/2"	M10	2,61	25	083810307
89	3"	M10	2,75	25	083810308
102	3 1/2"	M12	4,40	25	083810309
115	4"	M12	4,85	15	083810310
140	5"	M12	7,60	15	083810312
168	6"	M16	12,60	15	083810315
220	8"	M16	22,30	10	083810320
274	10"	M16	23,50	1	083810374
274	10"	M20	33,50	1	083810375
324	12"	M20	71,50	1	083810386
408	16"	M24	105,00	1	083810508

Robur

Robur

8383C

colares quadrados em U,
galvanizados a quente
Porcas com flange

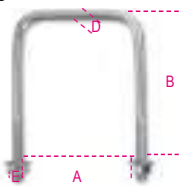

CERTIFICADOS DISPONÍVEIS

- Especificações de Produto
- Relatório de Teste UNI EN10204 tipo 2.2

A mm	E mm	B mm	D mm	€		
70	M10	110	8,55	2,20	130	083830070
80	M10	120	8,55	2,55	110	083830080
90	M10	130	8,55	2,75	100	083830090
100	M10	155	8,55	3,30	90	083830100
120	M10	175	8,55	3,85	70	083830120

8383P

placas para colares quadrados em U
zincados

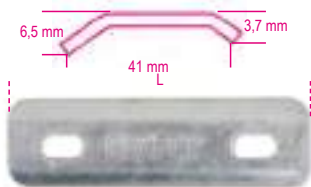

CERTIFICADOS DISPONÍVEIS

- Especificações técnicas
- Relatório de ensaio UNI EN10204 tipo 2.2

	L mm	€		
8383P 150 8383C/70-80 /90-100	150	2,75	150	083830214
8383P 170 8383C/100-120	170	3,30	120	083830217

8515Z

esticador de fios para agricultura zincados

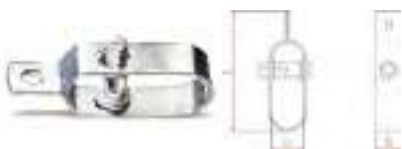

D mm	H mm	L mm	€		
20	25	93	1,44	50	085150002
24,5	30	100	1,99	50	085150003

8515V

esticador de fios para agricultura zincados e
pintados



D mm	H mm	L mm	€		
20	25	93	1,92	50	085150102
24,5	30	100	2,42	50	085150103

8515CH

esticador de fios,
zincado



L mm	OA mm	OB mm	€		
90	8	7,5	0,69	20	085150901

8531

manilhas tipo pesca zincadas a quente

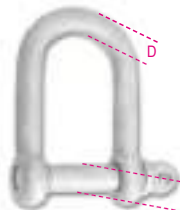

CERTIFICADOS DISPONÍVEIS

- Relatório de ensaio UNI EN10204 tipo 2.2

Ø mm	D mm	WFL kg	€		
20	18	1600	19,90	1	085310018
22	20	2500	29,00	1	085310020

8532

manilhas tipo pesca pintadas pretas

pino quadrado



CERTIFICADOS DISPONÍVEIS

- Relatório de ensaio UNI EN10204 tipo 2.2

Ø mm	D mm	WFL kg	€		
20	20	1600	9,80	1	085320020
22	22	2500	15,00	1	085320022

8535

ganchos tipo pesca zincados

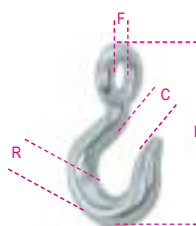

CERTIFICADOS DISPONÍVEIS

- Relatório de ensaio UNI EN10204 tipo 2.2

R	C	F	L	€		
26	27,5	34	156	22,30	1	085350006
30	36,5	40	185	30,50	1	085350007

8050 D1+D45

kit substituição de travão de segurança para
ganchos



	€		
8050D1 8064S-8065SC/800-8055S/1250	8,70	1	080500945
8050D2 8064S-8065SC/1000 8062/1500-8055S/1600	10,10	1	080500946
8050D3 8064S-8065SC/1600-2000 8055S/2500-3200	10,90	1	080500947
8050D4 8064S-8065SC/3200-8055S/5400	18,00	1	080500948
8050D5 8064S-8065SC/5000-8055S/8000	20,80	1	080500949
8050D6 8064S/7500-8055S/11500	33,00	1	080500950
8050D11 8062/2000	17,20	1	080500955
8050D12 8062/3000	18,90	1	080500956
8050D13 8062/5000	34,00	1	080500957
8050D22 8064S/10000 8055S/16000	45,00	1	080500966
8050D23 8055S/22000	62,50	1	080500967
8050D24 8051S/250	0,78	1	080500969
8050D25 8051S/500	0,93	1	080500970
8050D30 8061F/8000	25,00	1	080500975
8050D32 8060/8000	34,50	1	080500977
8050D 33 8052/800	3,45	1	080500978
8050D 34 8052/1120	3,90	1	080500979
8050D 35 8052/2000	4,75	1	080500980
8050D 36 8052/3150	5,20	1	080500981
8050D 37 8052/4000	6,20	1	080500982
8050D38 8060R/1120	2,25	1	080500983
8050D53 8060R/1500	3,05	1	080500994
8050D39 8060R/2000	3,05	1	080500984
8050D40 8060R/3150	5,40	1	080500985
8050D41 8060R/5300	8,30	1	080500986
8050D42 8063/800	0,78	1	080500987
8050D43 8063/1120	1,12	1	080500988
8050D44 8063/2000	1,45	1	080500989
8050D45 8063/3150	1,79	1	080500990

8050D46 8061R/1120	2,34	1	080500991
8050D47 8061R/2000	2,34	1	080500992
8050D48 8061R/3150	3,20	1	080500993
8050D54 8061R/5300	3,20	1	080500995

8050D49 8057R - 8058R - 8063SL /1120	6,50	1	080500849
8050D50 8057R - 8058R - 8063SL /2000	7,10	1	080500850
8050D51 8057R - 8058R - 8063SL /3150	7,70	1	080500851
8050D52 8057R - 8058R - 8063SL /5300	17,30	1	080500852

8058R/PS

kit de pinos para ganchos item 8058R-8061R



	∅ mm	€		
8058R/PS 1,12	6	7,60	1	080580512
8058R/PS 2,0	7-8	8,70	1	080580520
8058R/PS 3,15	10	17,30	1	080580532
8058R/PS 5,3	13	29,50	1	080580553

8060R/PS

kit de pinos para ganchos item 8060R



	∅ mm	€		
8060R/PS 1,12	6	7,60	1	080600511
8060R/PS 1,5	7	8,70	1	080600515
8060R/PS 2,0	8	8,70	1	080600520
8060R/PS 3,15	10	17,30	1	080600532
8060R/PS 5,3	13	29,50	1	080600553

8135/KLA1

kit alavanca de comando para gancho de elevação 8135



8135 t	€		
0,75	17,00	1	081350605
1,00	21,00	1	081350610
2,00	24,30	1	081350615
3,00	29,50	1	081350620
5,00	45,00	1	081350625

As reparações devem ser realizadas por pessoal qualificado.

8135/KMO

kit mola para gancho de elevação 8135



8135 t	€		
0,75	7,60	1	081350655
1,00	11,00	1	081350660
2,00	14,30	1	081350665
3,00	18,40	1	081350670
5,00	27,50	1	081350675

As reparações devem ser realizadas por pessoal qualificado.

8143/RKL

kit de fechos superior e inferior para diferenciais de corrente manuais 8143



8143 WLL t	€		
0,5	1,52	1	081430500
1,0	1,75	1	081430501
2,0	2,64	1	081430502
3,0	3,10	1	081430503
5,0	3,60	1	081430504

8143/RPC

kit de pinos de bloqueio para diferenciais de corrente manuais 8143



8143 WLL t	€		
0,5	1,82	1	081430510
1,0	2,49	1	081430511
2,0	2,69	1	081430512
3,0	4,40	1	081430513
5,0	4,75	1	081430514

8143/RPF

kit de batentes para diferenciais de corrente manuais 8143



8143 WLL t	€		
0,5	0,82	1	081430520
1,0	0,88	1	081430521
2,0	1,23	1	081430522
3,0	0,97	1	081430523
5,0	1,52	1	081430524

8143/RKCI

kit de ganchos inferiores para diferenciais de corrente manuais 8143



8143 WLL t	€		
0,5	11,80	1	081430560
1,0	15,50	1	081430561
2,0	29,00	1	081430562
3,0	94,50	1	081430563
5,0	131,00	1	081430564

8146/RK

fechos, pinos e batentes de segurança para os diferenciais de alavanca 8146C-8146



8146C WLL t	€		
0,25	5,90	1	081460920

8146/RKL

kit de fechos superior e inferior para diferenciais de alavanca 8146



8146 WLL t	€		
0,75	1,75	1	081460500
1,5	2,01	1	081460501
3,0	3,10	1	081460502
6,0	3,50	1	081460503

8146/RPC

kit de pinos de bloqueio para diferenciais de alavanca 8146



8146 WLL t	€		
0,75	1,82	1	081460510
1,5	2,69	1	081460511
3,0	2,84	1	081460512
6,0	2,84	1	081460513

8146/RKFC

kit de batentes para diferenciais de alavanca 8146



8146 WLL t	€		
0,75	4,85	1	081460520
1,5	6,20	1	081460521
3,0	6,70	1	081460522
6,0	7,80	1	081460523

Robur

Robur



8146/RKCI

kit de ganchos inferiores para diferenciais de alavanca 8146



8146 WLL t	€		
0,75	13,50	1	081460560
1,5	29,00	1	081460561
3,0	94,50	1	081460562
6,0	179,00	1	081460563

8148/RA

cruzeta para cabo de aço para guincho manual 8148



8148 t	€		
0,8	21,50	1	081480900
1,6	29,00	1	081480901
3,2	37,50	1	081480902

8148/RKS

conjunto de 3 pinos contra sobrecarga para guincho manual 8148



8148 t	€		
0,8	3,95	1	081480903
1,6 - 3,2	4,95	1	081480904

8148/RKCM

conjunto de 2 tampas do punho para guincho manual 8148



8148/RKCM	€		
	1,79	1	081480905

8148/RKCL

jogo de 2 tampas de alavanca para guincho manual 8148



8148/RKCL	€		
	1,91	1	081480906

8148/RP

pinos de ancoragem para guincho manual 8148



8148 t	€		
0,8	16,40	1	081480907
1,6	22,10	1	081480908
3,2	28,00	1	081480909

8148/RKG

jogo de 2 capas de proteção para guincho manual 8148



8148 t	€		
0,8	17,00	1	081480910
1,6	19,40	1	081480911
3,2	20,40	1	081480912



8149

correntes de elevação

CE



EN 818-7

CARACTERÍSTICAS TÉCNICAS

- fator de segurança: 4
 - tratamento a quente: reforçado e temperado
 - código de localização
- TESTES LABORATORIAIS
- análise química
 - análise metalográfica
 - teste de elasticidade
- CERTIFICADOS DISPONÍVEIS
- Especificações de produto
 - Relatório de Teste UNI EN10204 tipo 2.2
 - Declaração de Conformidade CE

Ø mm	WLL Kg	P mm	W min	€/m		
4	500	12	4,8	16,20	1	081490012
5	800	15	6,0	20,00	1	081490015
6	1100	18	7,2	22,40	1	081490018
6,3	1200	19	7,6	24,80	1	081490019
8	2000	24	9,6	33,50	1	081490024
10	3200	30	12	52,00	1	081490030

8149CM

correntes para diferencial de corrente 8143



Ø mm	B mm	t mm	€/m		
4,8	8,2	22,2	5,20	1	081490901

* ATENÇÃO: O produto é entregue com um comprimento de corrente, a menos que especificado de outra forma no pedido!

8149CM/RA

corrente de substituição para diferencial de corrente 8143



L m	Ø mm	B mm	€		
3	4,8	8,2	66,00	1	081490903
6	4,8	8,2	99,50	1	081490906

*Anel fechado soldado. Por favor, leia o manual ativamente antes de substituir a corrente.



Ao contrário do aço de utilização geral (AISI 304), o aço AISI 316 selecionado pela Beta oferece elevada resistência às intempéries, bem como à corrosão salina e à corrosão por sal e ácidos orgânicos. O aço inoxidável AISI 316 possui alto teor de:

- **Crómio** (forma uma película superficial que protege o material da oxidação)
- **Molibdênio** (aumenta a resistência à corrosão de cloretos, por exemplo, água do mar e produtos de descongelamento)
- **Níquel** (permite que a estrutura de aço se mantenha estável ao longo do tempo)

Além disso, o baixo teor de carbono torna este aço mais resistente à corrosão intergranular (um tipo particular de corrosão que dificilmente pode ser detetado na superfície do acessório e pode provocar quebras repentinas em ambientes corrosivos).

O aço AISI 316 possui algumas características adicionais: é fácil de limpar, possui excelente coeficiente higiénico, propriedades não magnéticas e bom desempenho mecânico em baixas temperaturas.

Sem dúvida, a qualidade uniforme e constante foi, e ainda é, o principal fator de fiabilidade dos produtos de aço inoxidável da Robur, pois garante que os mesmos níveis de desempenho sejam alcançados para todos os lotes de produção – ontem, hoje e amanhã.

8205

tensores de dois olhais
aço inoxidável AISI 316

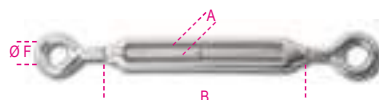

TESTES LABORATORIAIS

- análise química
 - ensaio de tracção
- CERTIFICADOS DISPONÍVEIS**
- Especificações técnicas
 - Relatório de ensaio UNI EN10204 tipo 2.2

A	B	ØF	WFL	€		
mm	mm	mm	kg			
M4	62	8	75	6,50	10	082050204
M5	72	11	115	7,80	10	082050205
M6	92	12	160	10,30	8	082050206
M8	122	14	300	15,80	8	082050208
M10	150	16	470	23,80	4	082050210
M12	201	18	690	40,50	1	082050212
M14	225	22	940	101,00	1	082050214
M16	244	26	1290	103,00	1	082050216
M20	295	29	2130	149,00	1	082050220
M24	350	33	3000	341,00	1	082050224

packs especiais



A	B	ØF	€		
mm	mm	mm			
M4	62	5	36,50	1	082050704
M5	72	5	43,50	1	082050705
M6	92	4	46,00	1	082050706
M8	122	4	71,00	1	082050708
M10	150	2	54,00	1	082050710

8206

tensores de olhal e gancho
aço inoxidável AISI 316

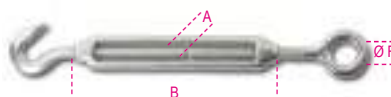

TESTES LABORATORIAIS

- análise química
 - ensaio de tracção
- CERTIFICADOS DISPONÍVEIS**
- Especificações técnicas
 - Relatório de ensaio UNI EN10204 tipo 2.2

A	B	ØF	WFL	€		
mm	mm	mm	kg			
M5	72	11	25	7,90	10	082060205
M6	92	12	45	10,90	5	082060206
M8	122	14	95	16,50	5	082060208
M10	150	16	140	25,00	1	082060210
M12	201	18	300	42,00	1	082060212
M14	225	22	420	102,00	1	082060214
M16	244	26	570	104,00	1	082060216
M20	295	29	875	152,00	1	082060220

8207

tensores de dois ganchos
aço inoxidável AISI 316

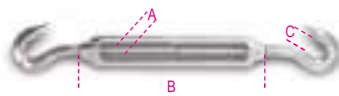

TESTES LABORATORIAIS

- análise química
 - ensaio de tracção
- CERTIFICADOS DISPONÍVEIS**
- Especificações técnicas
 - Relatório de ensaio UNI EN10204 tipo 2.2

A	B	C	WFL	€		
mm	mm	mm	kg			
M5	72	9	25	8,30	10	082070205
M6	92	9	45	11,00	5	082070206
M8	122	10	95	16,80	5	082070208
M10	150	12	140	25,50	1	082070210
M12	201	14	300	42,50	1	082070212
M14	225	15	420	103,00	1	082070214
M16	244	16	570	107,00	1	082070216
M20	295	19	875	157,00	1	082070220

8209

tensores de duas forquilhas
aço inoxidável AISI 316

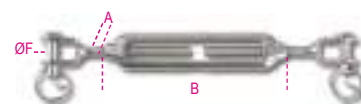

TESTES LABORATORIAIS

- análise química
 - ensaio de tracção
- CERTIFICADOS DISPONÍVEIS**
- Especificações técnicas
 - Relatório de ensaio UNI EN10204 tipo 2.2

A	B	ØF	WFL	€		
mm	mm	mm	kg			
M5	72	5	115	13,90	5	082090205
M6	92	6	160	16,30	5	082090206
M8	122	8	300	23,50	5	082090208
M10	150	10	470	38,50	1	082090210
M12	201	12	690	62,00	1	082090212
M14	225	14	940	83,50	1	082090214
M16	244	16	1290	126,00	1	082090216
M20	295	20	2130	222,00	1	082090220
M24	350	24	3060	540,00	1	082090224

8210

tensores de duas forquilhas
aço inoxidável AISI 316



TESTES LABORATORIAIS

- análise química
 - ensaio de tracção
- CERTIFICADOS DISPONÍVEIS**
- Especificações técnicas
 - Relatório de ensaio UNI EN10204 tipo 2.2

A	B	ØF	WFL	€		
mm	mm	mm	kg			
M5	81	5	115	17,50	3	082100205
M6	92	6	160	21,00	3	082100206
M8	112	8	300	30,50	1	082100208
M10	121	10	470	48,00	1	082100210
M12	150	12	690	79,50	1	082100212
M14	169	14	940	103,00	1	082100214
M16	190	16	1290	153,00	1	082100216
M20	220	20	2130	265,00	1	082100220

8210FTP

tensor de forquilha com parafusos de fixação e mordente fixo em aço inox
AISI 316

Aço com níquel, cromo e molibdênio para maior resistência à corrosão.

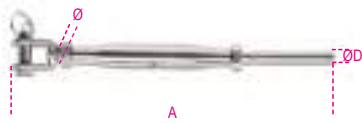

TESTES LABORATORIAIS

- análise química
 - ensaio de tensão
- CERTIFICADOS DISPONÍVEIS**
- Especificações técnicas
 - Relatório de teste UNI EN10204 tipo 2.2

Ø mm	A mm	ØD mm	WFL kg	€		
M5	159	2,70	150	19,50	2	082100605
M6	179	3,30	250	23,00	2	082100606
M8	216	4,30	350	31,50	1	082100608
M10	241	5,30	550	48,50	1	082100610
M12	300	6,30	1000	70,50	1	082100612
M14	345	7,30	1350	107,00	1	082100614
M16	383	8,30	1625	155,00	1	082100616
M20	484	10,50	2125	264,00	1	082100620

8201T

corpo para tensores
AISI 316



TESTES LABORATORIAIS

- análise química
 - teste elasticidade
- CERTIFICADOS DISPONÍVEIS**
- Especificações do Produto
 - Relatório de Teste UNI EN10204 tipo 2.2

Ø mm	Ø "	WFL kg	L mm	€		
M6	1/4	160	95	3,90	5	082010406
M8	5/16	300	105	5,80	5	082010408
M10	3/8	470	125	9,70	3	082010410
M12	1/2	690	150	16,80	3	082010412
M14	9/16	940	165	17,90	1	082010414
M16	5/8	1290	190	30,50	1	082010416
M20	3/4	2130	210	45,50	1	082010420

8210F

tensores de forquilha,
aço inox AISI 316

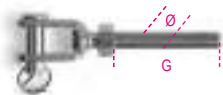

TESTES LABORATORIAIS

- análise química
 - ensaio de tensão
- CERTIFICADOS DISPONÍVEIS**
- Especificações técnicas
 - Relatório de teste UNI EN10204 tipo 2.2

Ø mm	Ø "	G mm	WFL kg	€		
M5	3/16	38,5	115	5,80	4	082100305
M6	1/4	49	160	6,50	4	082100306
M8	5/16	56	300	9,40	4	082100308
M10	3/8	61	470	16,10	2	082100310
M12	1/2	81	690	25,50	2	082100312
M14	9/16	93	940	40,00	2	082100314

forquilhas para tensores direitos - zincadas

Ø mm	Ø "	G mm	WFL kg	€		
M5	3/16	38,5	115	5,80	4	082100405
M6	1/4	49	160	6,50	4	082100406
M8	5/16	56	300	9,40	4	082100408
M10	3/8	61	470	16,10	2	082100410
M12	1/2	81	690	25,50	2	082100412
M14	9/16	93	940	41,00	2	082100414

8248

tirantes de olhal
aço inoxidável 316L,
rosca direita



UNI 6058

CERTIFICADOS DISPONÍVEIS

- Especificações do Produto
- Relatório de Teste UNI EN10204 tipo 2.2

ØxL mm	F mm	€		
8X120	6	7,60	1	082480008
10x80	8	10,20	1	082480010
10x130	8	13,60	1	082480012
12x95	10	15,40	1	082480016
12x125	10	18,30	1	082480018

8249

argolas de pressão
aço inoxidável AISI 316



TESTES LABORATORIAIS

- análise química
 - ensaio de tração
- CERTIFICADOS DISPONÍVEIS**
- Especificações técnicas
 - Relatório de ensaio UNI EN10204 tipo 2.2

A mm	WFL kg	D mm	€		
M5	100	50	2,80	10	082490205
M6	160	55	3,50	10	082490206
M8	300	60	5,70	5	082490208
M10	470	80	10,20	5	082490210
M12	690	120	17,70	2	082490212

8249G

ganchos de fixação
AISI 316



TESTES LABORATORIAIS

- análise química
 - teste elasticidade
- CERTIFICADOS DISPONÍVEIS**
- Especificações do Produto
 - Relatório de Teste UNI EN10204 tipo 2.2

A mm	E mm	ØF mm	WFL kg	€		
M5	39	9	25	1,34	5	082490305
M6	43	10,5	45	1,60	5	082490306
M8	57	14,5	95	2,80	3	082490308

8216

cerra cabos
aço inoxidável AISI 316

CE

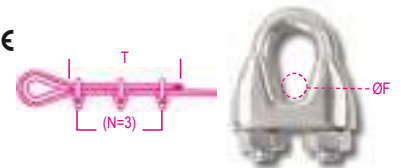

TESTES LABORATORIAIS

- análise química
 - teste binário
- CERTIFICADOS DISPONÍVEIS**
- Especificações técnicas
 - Relatório de ensaio UNI EN10204 tipo 2.2
 - Certificado de Conformidade CE

Ø F mm	"	T	N	€		
2	5/64	80	3	3,25	20	082160202
3	1/8	80	3	3,30	20	082160203
4	5/32	80	3	3,70	20	082160204
5	3/16	110	3	4,20	20	082160205
6	1/4	120	5	4,70	10	082160206
8	5/16	210	5	6,30	10	082160208
10	3/8	240	5	8,80	8	082160210
12-13	1/2	300	5	12,10	5	082160213
16	5/8	335	5	17,90	5	082160216
20	3/4	540	5	22,60	5	082160220
22	7/8	595	7	36,50	3	082160222

packs especiais



Ø F mm	"	€		
2	5/64	37,00	1	082160702
3	1/8	37,50	1	082160703
4	5/32	42,00	1	082160704
5	3/16	47,50	1	082160705
6	1/4	27,00	1	082160706
8	5/16	35,00	1	082160708
10	3/8	39,50	1	082160710

Embalagens especiais com blister



Ø F mm		€		
2	4	13,80	1	082169402
3	4	13,90	1	082169403
4	4	15,60	1	082169404
5	2	9,40	1	082169405
6	2	10,70	1	082169406
8	2	13,80	1	082169408
10	2	18,60	1	082169410



8220

guarda cabos
aço inoxidável AISI 316

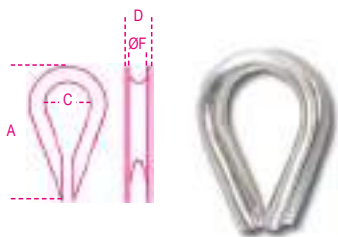

TESTES LABORATORIAIS

- análise química
- CERTIFICADOS DISPONÍVEIS**
- Especificações técnicas
- Relatório de ensaio UNI EN10204 tipo 2.2

Ø F mm	D mm	A mm	C mm	€		
2	4,5	21	7,5	1,06	15	082200202
3	6	24	10	1,16	15	082200203
4	6,6	28	11	1,34	10	082200204
5	8,5	30	13	1,60	10	082200205
6	10	37	15	1,82	10	082200206
8	12,5	51	23	2,87	5	082200208
10	14,6	56	27	3,50	5	082200210
12	18	68	32	4,85	5	082200212
14	19	69	34	6,30	5	082200214
16	22	83	37	7,10	5	082200216
18	23	81	38	8,30	1	082200218
20	27,8	105	45	9,80	1	082200220
22	29,6	112	45	12,80	1	082200222

8225

manilhas direitas
aço inoxidável AISI 316



TESTES LABORATORIAIS

- análise química
- ensaio de tracção
- CERTIFICADOS DISPONÍVEIS**
- Especificações técnicas
- Relatório de ensaio UNI EN10204 tipo 2.2

Ø D mm	A mm	WFL kg	€		
4	5/32	8	50	3,40	20 082250204
5	3/16	11	70	3,80	20 082250205
6	1/4	13	100	4,10	10 082250206
8	5/16	17	250	6,70	10 082250208
10	3/8	21	400	9,70	8 082250210
12	1/2	25	600	15,80	3 082250212
16	5/8	32	1000	34,50	1 082250216
19	3/4	38	1600	58,00	1 082250219
22	7/8	43	2000	90,00	1 082250222
25	1	46	2800	132,00	1 082250225

packs especiais



Ø D mm	A mm	WFL kg	€		
4	5/32	10	38,50	1	082250704
5	3/16	10	42,50	1	082250705
6	1/4	5	23,00	1	082250706
8	5/16	5	37,50	1	082250708
10	3/8	4	43,00	1	082250710

8227

manilhas direitas, longas
aço inoxidável AISI 316



TESTES LABORATORIAIS

- análise química
- ensaio de tracção
- CERTIFICADOS DISPONÍVEIS**
- Especificações técnicas
- Relatório de ensaio UNI EN10204 tipo 2.2

Ø D mm	A mm	WFL kg	€		
4	5/32	8	50	2,87	10 082270204
5	3/16	10	70	3,30	10 082270205
6	1/4	13,5	100	4,20	5 082270206
8	5/16	17	250	6,90	5 082270208
10	3/8	21	400	11,40	2 082270210
12	1/2	25	600	18,00	1 082270212

8228

manilhas forma lira
aço inoxidável AISI 316

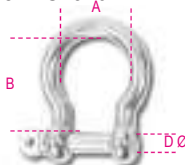

TESTES LABORATORIAIS

- análise química
- ensaio de tracção
- CERTIFICADOS DISPONÍVEIS**
- Especificações técnicas
- Relatório de ensaio UNI EN10204 tipo 2.2

Ø D mm	A mm	B mm	WFL kg	€		
4	13	20	60	2,60	10	082280204
5	17	23	80	3,00	10	082280205
6	20	27	100	3,40	10	082280206
8	28	36	200	5,50	5	082280208
10	36	44	300	8,80	5	082280210
12	41	53	500	14,00	5	082280212
16	54	74	800	30,50	1	082280216
19	66	86	1100	56,00	1	082280219

8240F

argolas macho FORJADAS,
aço inoxidável A4

CE



CARACTERÍSTICAS TÉCNICAS

- factor de segurança: 6
- código de identificação
- TESTES LABORATORIAIS**
- análise química
- análise metalográfica
- ensaio de tracção
- CERTIFICADOS DISPONÍVEIS**
- Especificações técnicas
- Relatório de ensaio UNI EN10204 tipo 2.2
- Certificado de inspeção UNI EN10204 tipo 3.1
- Declaração de Conformidade CE

Ø mm	WLL kg	€		
M6	1,0	120	7,90	4 082400406
* M8	1,25	200	8,80	4 082400408
* M10	1,5	400	14,70	4 082400410
* M12	1,75	600	23,90	4 082400412
* M14	2	1000	38,50	2 082400414
* M16	2	1200	38,50	2 082400416
* M20	2,5	2000	62,00	2 082400420
* M24	3	2700	118,00	2 082400424
* M30	3,5	4000	260,00	1 082400430

8240

argolas macho
aço inoxidável AISI 316



TESTES LABORATORIAIS

- análise química
- ensaio de tracção
- CERTIFICADOS DISPONÍVEIS**
- Especificações técnicas
- Relatório de ensaio UNI EN10204 tipo 2.2

A mm	B mm	Ø C mm	WFL kg	€		
M6	41	15	90	2,24	10	082400206
M8	50	20	140	3,35	10	082400208
M10	62	25	230	6,80	5	082400210
M12	74	30	340	11,40	5	082400212

8242F

argolas fêmea FORJADAS,
aço inoxidável A4

CE



CARACTERÍSTICAS TÉCNICAS

- factor de segurança: 6
- código de identificação

TESTES LABORATORIAIS

- análise química
- análise metalográfica
- ensaio de tracção

CERTIFICADOS DISPONÍVEIS

- Especificações técnicas
- Relatório de ensaio UNI EN10204 tipo 2.2
- Certificado de inspecção UNI EN10204 tipo 3.1
- Declaração de Conformidade CE

ø mm	WLL kg	€	📦	🚚
M6	1,0 120	7,90	4	082420406
* M8	1,25 200	8,80	4	082420408
* M10	1,5 400	14,70	4	082420410
* M12	1,75 600	23,90	4	082420412
* M14	2 1000	38,50	2	082420414
* M16	2 1200	38,50	2	082420416
* M20	2,5 2000	62,00	2	082420420
* M24	3 2700	118,00	2	082420424
* M30	3,5 4000	260,00	1	082420430

8242

argolas fêmea
aço inoxidável AISI 316



A mm	B mm	ø C mm	WFL kg	€	📦	🚚
M6	27	15	90	2,24	10	082420206
M8	36	20	140	3,35	10	082420208
M10	45	25	230	6,80	5	082420210
M12	55	30	340	11,40	5	082420212

8274

mosquetão
aço inoxidável AISI 316



TESTES LABORATORIAIS

- análise química
- ensaio de tracção

CERTIFICADOS DISPONÍVEIS

- Especificações técnicas
- Relatório de ensaio UNI EN10204 tipo 2.2

ø A x L mm	ø C mm	D mm	WFL kg	€	📦	🚚
4,5x40	6,5	6	20	3,05	20	082740204
5x50	7	6,5	30	3,05	20	082740205
6x60	8,5	7,5	40	3,25	10	082740206
7x70	10	9	60	3,90	10	082740207
8x80	12	10	75	5,20	10	082740208
9x90	12,5	10,5	100	7,20	10	082740209
10x100	15	13	120	8,90	8	082740210
11x120	19	18	140	12,80	1	082740211
12x140	22	21	140	17,40	1	082740212
13x160	22	26	200	21,80	1	082740213

packs especiais



ø A x L mm	ø C mm	📦	€	🚚
4,5x40	6,5	10	34,50	1 082740704
5x50	7	10	34,50	1 082740705
6x60	8,5	5	18,30	1 082740706
7x70	10	5	21,90	1 082740707
8x80	12	5	29,50	1 082740708
9x90	12,5	5	40,00	1 082740709
10x100	15	4	40,00	1 082740710

8274A

ganchos articulados
AISI 316

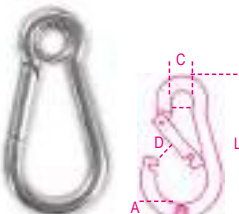

TESTES LABORATORIAIS

- análise química
- teste elasticidade

CERTIFICADOS DISPONÍVEIS

- Especificações do Produto
- Relatório de Teste UNI EN10204 tipo 2.2

ø A x L mm	ø C mm	D mm	WFL kg	€	📦	🚚
5x50	6,5	7	30	3,00	10	082740405
6x60	7,5	7,5	40	3,60	5	082740406
8x80	9,5	10	75	6,00	5	082740408

8274G

mosquetão com porca
aço inoxidável AISI 316

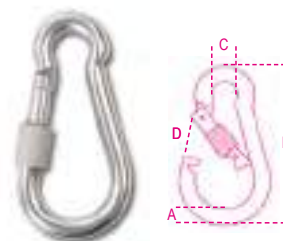

TESTES LABORATORIAIS

- análise química
- ensaio de tracção

CERTIFICADOS DISPONÍVEIS

- Especificações técnicas
- Relatório de ensaio UNI EN10204 tipo 2.2

ø A x L mm	ø C mm	D mm	WFL kg	€	📦	🚚
6x60	8,5	6,5	40	4,00	5	082740306
8x80	12	8,5	75	7,20	5	082740308
10x100	15	12	120	13,80	3	082740310

8276

mosquetão assimétrico
aço inoxidável AISI 316

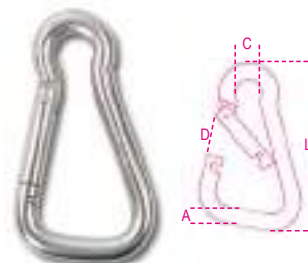

TESTES LABORATORIAIS

- análise química
- ensaio de tracção

CERTIFICADOS DISPONÍVEIS

- Especificações técnicas
- Relatório de ensaio UNI EN10204 tipo 2.2

ø A x L mm	ø C mm	D mm	WFL kg	€	📦	🚚
6x60	8,5	10	40	3,60	5	082760206
8x80	12	14	75	6,30	5	082760208
10x100	15	18	120	11,10	3	082760210

Robur

Robur

8276G

mosquetão assimétrico com porca
aço inoxidável AISI 316

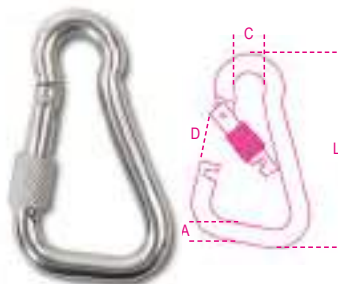

TESTES LABORATORIAIS

- análise química
 - ensaio de tracção
- CERTIFICADOS DISPONÍVEIS**
- Especificações técnicas
 - Relatório de ensaio UNI EN10204 tipo 2.2

ø A x L mm	ø C mm	D mm	WFL kg	€		
6x60	8,5	9	40	4,60	3	082760306
8x80	12	12,5	75	8,30	3	082760308
10x100	15	16	120	15,20	3	082760310

8278

mosquetão trapezoidal
aço inoxidável AISI 316

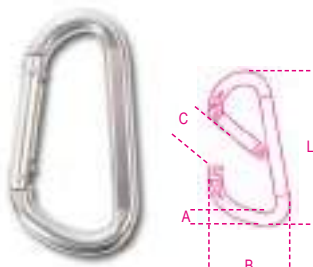

TESTES LABORATORIAIS

- análise química
 - ensaio de tracção
- CERTIFICADOS DISPONÍVEIS**
- Especificações técnicas
 - Relatório de ensaio UNI EN10204 tipo 2.2

ø A x L mm	B mm	C mm	WFL kg	€		
8x80	45	14	75	14,00	3	082780208
10x100	55	16	120	21,80	3	082780210

Robur

8280

elos de ligação rápida
aço inoxidável AISI 316

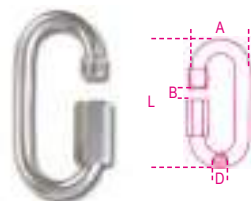

TESTES LABORATORIAIS

- análise química
 - ensaio de tracção
- CERTIFICADOS DISPONÍVEIS**
- Especificações técnicas
 - Relatório de ensaio UNI EN10204 tipo 2.2

ø D x L mm	A mm	B mm	WFL kg	€		
3,5x35	17	5	20	3,55	10	082800203
4x40	19	6	30	3,80	10	082800204
5x50	23	7	50	4,60	5	082800205
6x60	26	8	60	5,50	5	082800206
7x70	30	9	100	6,30	5	082800207
8x80	33	10	140	8,90	2	082800208
10x90	40	12	220	14,40	2	082800210
12x100	47	14	300	21,80	1	082800212

8250

mosquetão de olhal
aço inoxidável AISI 316



TESTES LABORATORIAIS

- análise química
 - ensaio de tracção
- CERTIFICADOS DISPONÍVEIS**
- Especificações técnicas
 - Relatório de ensaio UNI EN10204 tipo 2.2

L mm	A mm	ø B mm	WFL kg	€		
50	25	8	40	4,45	5	082500205
70	31	12,5	90	6,90	5	082500207
100	47	20	190	11,10	2	082500210

8264

ganchos rotativos
aço inoxidável AISI 316

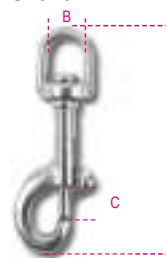

TESTES LABORATORIAIS

- análise química
 - ensaio de tracção
- CERTIFICADOS DISPONÍVEIS**
- Especificações técnicas
 - Relatório de ensaio UNI EN10204 tipo 2.2

B mm	L mm	C mm	WFL kg	€		
12	88	12	60	12,00	5	082640212
16	90	12	60	12,40	5	082640216
19	93	12	60	12,50	2	082640219

8267

mosquetão de olhal rotativo
aço inoxidável AISI 316



TESTES LABORATORIAIS

- análise química
 - ensaio de tracção
- CERTIFICADOS DISPONÍVEIS**
- Especificações técnicas
 - Relatório de ensaio UNI EN10204 tipo 2.2

A mm	L mm	B mm	WFL kg	€		
10	87	21	30	10,70	5	082670210
12	118	22	70	17,80	2	082670213

Robur

Robur

8272

elos de ligação rotativos
aço inoxidável AISI 316

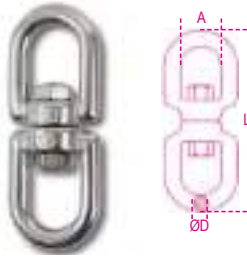

TESTES LABORATORIAIS

- análise química
 - ensaio de tracção
- CERTIFICADOS DISPONÍVEIS**
- Especificações técnicas
 - Relatório de ensaio UNI EN10204 tipo 2.2

Ø D mm	A mm	L mm	WFL kg	€		
4	11	50	90	6,00	5	082720204
5	13	60	115	7,90	5	082720205
6	15	66	140	9,70	5	082720206
8	19	90	250	15,60	3	082720208
10	23	112	300	24,00	1	082720210
13	33	148	650	48,50	1	082720213
16	38	184	1000	90,50	1	082720216
19	40	223	1600	162,00	1	082720219

8273

gancho desengate rápido
com olhal rotativo
aço inox AISI 316

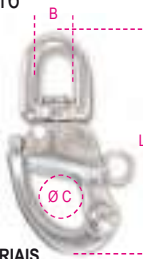

TESTES LABORATORIAIS

- análise química
 - ensaio de tracção
- CERTIFICADOS DISPONÍVEIS**
- Especificações técnicas
 - Relatório de ensaio UNI EN10204 tipo 2.2

Ø C x L mm	B mm	WFL kg	BF kg	€		
12x70	12	230	1100	18,30	1	082730012
16x85	14,50	440	2000	25,50	1	082730016
22x120	20	700	3500	40,00	1	082730022

8282S

Ganchos tipo "S", aço inox AISI 316

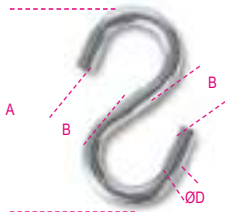

TESTES LABORATORIAIS

- Análise química
 - Ensaio de tracção
- CERTIFICADOS DISPONÍVEIS**
- Especificações técnicas
 - Relatório de ensaio UNI EN10204 tipo 2.2

Ø D mm	B mm	A mm	WFL kg	€		
3	5,5	34	4	0,32	40	082820303
4	7,0	40	5	0,65	30	082820304
5	9,0	46	12	1,06	20	082820305
6	10	54	18	1,76	15	082820306

8284

mosquetão pelicano
aço inox AISI 316



TESTES LABORATORIAIS

- análise química
 - ensaio de tracção
- CERTIFICADOS DISPONÍVEIS**
- Especificações técnicas
 - Relatório de ensaio UNI EN10204 tipo 2.2

Ø C mm	B mm	L mm	WFL kg	€		
6	11	73	200	17,70	3	082840006
8	14	98	300	23,90	3	082840008
10	23	143	450	49,50	1	082840010

8285

terminais em forquilha
aço inoxidável AISI 316

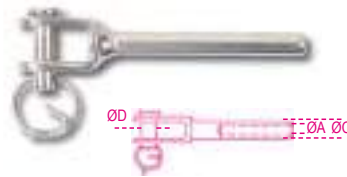

TESTES LABORATORIAIS

- análise química
 - ensaio de tracção
- CERTIFICADOS DISPONÍVEIS**
- Especificações técnicas
 - Relatório de ensaio UNI EN10204 tipo 2.2

Ø A M	Ø C mm	Ø D mm	WFL kg	€		
3	6,3	6	180	3,50	5	082850203
4	7,5	8	200	5,70	3	082850204
5	9	10	330	7,80	2	082850205
6	12,5	12	720	16,10	2	082850206
7	12,5	12	850	17,30	2	082850207
8	15,5	16	1120	23,10	2	082850208
10	18	16	1300	32,50	2	082850210
12	20	19	2400	39,00	2	082850212

8286

terminais em olhal
aço inoxidável AISI 316



TESTES LABORATORIAIS

- análise química
 - ensaio de tracção
- CERTIFICADOS DISPONÍVEIS**
- Especificações técnicas
 - Relatório de ensaio UNI EN10204 tipo 2.2

Ø D M	Ø A mm	Ø C mm	WFL kg	€		
3	6,5	6,3	180	3,60	5	082860203
4	8,5	7,5	200	4,20	3	082860204
5	10	9	330	5,70	2	082860205
6	12,5	12,6	720	9,30	2	082860206
7	12,5	14,2	850	10,10	2	082860207
8	14,5	16	1120	16,80	2	082860208
10	16,4	18	1300	29,50	2	082860210
12	19,3	20	2400	42,00	2	082860212

8287

terminais em tubo
aço inoxidável AISI 316



TESTES LABORATORIAIS

- análise química
 - ensaio de tracção
- CERTIFICADOS DISPONÍVEIS**
- Especificações técnicas
 - Relatório de ensaio UNI EN10204 tipo 2.2

Ø D M	Ø A mm	E mm	WFL kg	€		
3	6,2	M6	180	3,15	5	082870203
4	7,5	M8	200	4,45	3	082870204
5	8,7	M10	330	6,30	2	082870205
6	12,6	M12	720	11,50	2	082870206
7	12,6	M14	850	16,00	2	082870207
8	16	M16	1120	23,10	2	082870208
10	18	M16	1300	25,50	2	082870210
12	20	M20	2400	35,00	2	082870212

8290

abraçadeiras para tubos
aço inoxidável AISI 316



TESTES LABORATORIAIS

- análise química
 - ensaio de tracção
- CERTIFICADOS DISPONÍVEIS**
- Especificações técnicas
 - Relatório de ensaio UNI EN10204 tipo 2.2

Ø A mm	B mm	Ø C mm	L mm	€		
5	18	4,3	40	1,13	5	082900205
6	22	5,2	44	1,60	5	082900206
8	23	5,2	51	2,53	5	082900208



8381SX

colares para sustentar tubulações

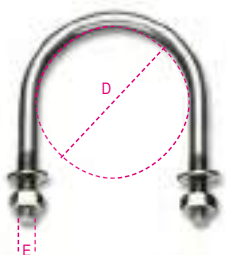

AISI 304

TESTES LABORATORIAIS

- análise química
- CERTIFICADOS DISPONÍVEIS
- Relatório de ensaio UNIEN10204 tipo 2.2

D mm	D gas	E mm	€	1	2
11	1/8"	M6	2,80	20	083810401
14	1/4"	M6	2,87	20	083810402
18	3/8"	M6	2,95	20	083810403
22	1/2"	M6	3,00	20	083810404
27	3/4"	M6	3,05	20	083810405
34	1"	M6	3,25	20	083810406
43	1 1/4"	M6	3,70	20	083810407
49	1 1/2"	M8	6,70	10	083810408
61	2"	M8	7,40	10	083810409
77	2 1/2"	M8	8,50	10	083810410
89	3"	M8	9,40	10	083810412
115	4"	M8	12,10	10	083810413
168	6"	M10	23,10	1	083810416
220	8"	M10	28,00	1	083810418

8279

corrente para uniões estáticas, aço inoxidável AISI 304



CARACTERÍSTICAS TÉCNICAS

- fator de segurança: 4
- CERTIFICADOS DISPONÍVEIS
- Especificações técnicas
- Relatório de teste UNI EN10204 tipo 2.2

Ø mm	nr	WFL kg	m	€	1	2
2	13	20	50	273,00	1	082790020
3	17	55	50	498,00	1	082790030
4	19	100	50	705,00	1	082790040
5	21	250	40	775,00	1	082790050
6	23	310	30	785,00	1	082790060
8	27	400	15	775,00	1	082790080
10	30	1000	10	1.210,00	1	082790400

8293

esticador com roquete AISI 304 em poliéster muito resistente, LC 300 kg, com ganchos

possibilidade de suspensão



L m	L2 mm	L1 mm	STF daN	€	1	2
6	5700	300	100	78,50	1	082930106

LC = 300 kg

8297C

esticador com roquete, AISI 304 em poliéster de elevada resistência, LC 700 kg

possibilidade de suspensão

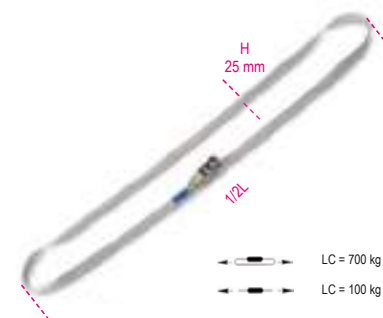

L m	H mm	€	1	2
5	25	30,00	1	082970350

8297F

2 cintas de fivela, AISI 304, em poliéster de elevada resistência, LC 250 kg

possibilidade de suspensão

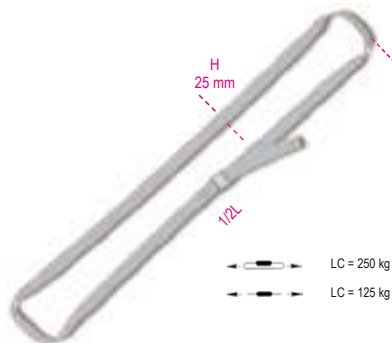

L m	H mm	€	1	2
3	25	30,00	1	082970230

LC = 250 kg

ESLINGA EM POLYESTER

Fator Segurança: 7:1

Certificado de Fábrica (UNI EM 1492)

CARACTERÍSTICAS TÉCNICAS

- fator de segurança: 7
- código de identificação
- TESTES LABORATORIAIS
- ensaio de tracção
- CERTIFICADOS DISPONÍVEIS
- Especificações técnicas
- Relatório de ensaio UNI EN10204 tipo 2.2
- Certificado do fabricante UNI EN1492
- Declaração de Conformidade CE

	1t	0,8t	2t	1,4t	1t
1t	0,8t	2t	1,4t	1t	
2t	1,5t	4t	2,8t	2t	
3t	2,4t	6t	4,2t	3t	
4t	3,2t	8t	5,6t	4t	
5t	4t	10t	7t	5t	
6t	4,8t	12t	8,4t	6t	
8t	6,4t	16t	11,2t	8t	
10t	8t	20t	14t	10t	
12t	9,6t	24t	16,8t	12t	
15t	12t	30t	21t	15t	
20t	16t	40t	28t	20t	
25t	20t	50t	35t	25t	
30t	24t	60t	42t	30t	
40t	32t	80t	56t	40t	
50t	40t	100t	70t	50t	

8150

estropos de elevação, roxo, 1t, tecido duplo com olhais reforçados, cinta em poliéster de elevada resistência (PES)

CE



EN 1492-1

L m	H mm	WLL ton	€	1	2
0,5	30	1	5,00	1	081500005
1	30	1	6,30	1	081500010
1,5	30	1	8,10	1	081500015
2	30	1	9,00	1	081500020
2,5	30	1	10,30	1	081500025
3	30	1	11,40	1	081500030
3,5	30	1	12,60	1	081500035
4	30	1	14,60	1	081500040
5	30	1	17,30	1	081500050
6	30	1	19,80	1	081500060
8	30	1	26,00	1	081500080

Robur



8153

estropos de elevação, verde, 2t, tecido duplo com olhais reforçados, cinta em poliéster de elevada resistência (PES)

CE



EN 1492-1

L m	H mm	WLL ton	€	U	U
1	60	2	10,00	1	081530010
1,5	60	2	13,40	1	081530015
2	60	2	15,40	1	081530020
2,5	60	2	18,10	1	081530025
3	60	2	20,90	1	081530030
3,5	60	2	24,40	1	081530035
4	60	2	26,00	1	081530040
5	60	2	31,50	1	081530050
6	60	2	37,50	1	081530060
8	60	2	47,50	1	081530080
10	60	2	57,50	1	081530100

8156

estropos de elevação, amarelo, 3t tecido duplo com olhais reforçados, cinta em poliéster de elevada resistência (PES)

CE



EN 1492-1

L m	H mm	WLL ton	€	U	U
1	90	3	14,10	1	081560010
1,5	90	3	18,60	1	081560015
2	90	3	23,00	1	081560020
2,5	90	3	27,50	1	081560025
3	90	3	32,00	1	081560030
3,5	90	3	35,50	1	081560035
4	90	3	39,50	1	081560040
5	90	3	48,00	1	081560050
6	90	3	56,00	1	081560060
8	90	3	73,00	1	081560080
10	90	3	89,50	1	081560100
12	90	3	112,00	1	081560120

8157

estopros de elevação, cinzento, 4t tecido duplo com olhais reforçados, cinta em poliéster de elevada resistência (PES)

CE



EN 1492-1

L m	H mm	WLL ton	€	U	U
2	120	4	31,50	1	081570020
3	120	4	42,00	1	081570030
4	120	4	54,50	1	081570040
5	120	4	66,00	1	081570050
6	120	4	76,50	1	081570060
8	120	4	99,00	1	081570080
10	120	4	122,00	1	081570100
12	120	4	153,00	1	081570120

8158

estropos de elevação, vermelho, 5t tecido duplo com olhais reforçados, cinta em poliéster de elevada resistência (PES)

CE



EN 1492-1

L m	H mm	WLL ton	€	U	U
2	150	5	43,50	1	081580020
3	150	5	57,50	1	081580030
4	150	5	73,00	1	081580040
5	150	5	88,00	1	081580050
6	150	5	104,00	1	081580060
8	150	5	134,00	1	081580080
10	150	5	165,00	1	081580100
12	150	5	207,00	1	081580120



8159

estopros de elevação, castanho, 6t tecido duplo com olhais reforçados, cinta em poliéster de elevada resistência (PES)

CE



EN 1492-1

L m	H mm	WLL ton	€	U	U
2	180	6	54,50	1	081590020
3	180	6	80,00	1	081590030
4	180	6	103,00	1	081590040
5	180	6	124,00	1	081590050
6	180	6	145,00	1	081590060
8	180	6	189,00	1	081590080
10	180	6	234,00	1	081590100

8160

estopros de elevação, azul, 8t tecido duplo com olhais reforçados, cinta em poliéster de elevada resistência (PES)

CE



EN 1492-1

L m	H mm	WLL ton	€	U	U
3	240	8	110,00	1	081600030
4	240	8	140,00	1	081600040
5	240	8	166,00	1	081600050
6	240	8	197,00	1	081600060
8	240	8	254,00	1	081600080
10	240	8	315,00	1	081600100

8161

estropos de elevação, laranja,
10t tecido duplo,
20t tecido quatro camadas,
olhais reforçados

CE



EN 1492-1

L m	H mm	WLL ton	€	📄	📱
3	300	10	151,00	1	081610030
4	300	10	223,00	1	081610040
5	300	10	267,00	1	081610050
6	300	10	310,00	1	081610060
8	300	10	410,00	1	081610080
10	300	10	499,00	1	081610100
12	300	10	600,00	1	081610120
3	300	20	494,00	1	081612030
4	300	20	620,00	1	081612040
5	300	20	750,00	1	081612050
6	300	20	875,00	1	081612060
8	300	20	1.130,00	1	081612080
10	300	20	1.380,00	1	081612100
12	300	20	1.640,00	1	081612120

8170

estropos redondos, roxo, 1t
cinta em poliester de elevada resistência
(PES)

CE



EN 1492-2

L m	WLL ton	H mm	€	📄	📱
0,5	1	45	5,70	1	081700010
1	1	45	7,50	1	081700020
1,5	1	45	10,50	1	081700030
2	1	45	13,70	1	081700040
2,5	1	45	16,80	1	081700050
3	1	45	19,80	1	081700060
4	1	45	26,00	1	081700080
5	1	45	32,50	1	081700100

8173

estropos redondos, verde, 2t
cinta em poliester de elevada resistência
(PES)

CE

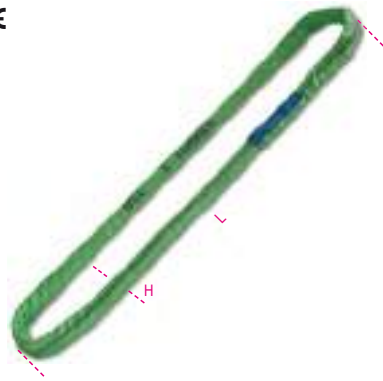

EN 1492-2

L m	H mm	WLL ton	€	📄	📱
0,5	50	2	7,50	1	081730010
1	50	2	11,40	1	081730020
1,5	50	2	16,50	1	081730030
2	50	2	21,70	1	081730040
2,5	50	2	27,00	1	081730050
3	50	2	31,50	1	081730060
4	50	2	42,50	1	081730080
5	50	2	53,50	1	081730100
6	50	2	64,00	1	081730120
8	50	2	83,00	1	081730160

8176

estropos redondos, amarelo, 3t
cinta em poliester de elevada resistência
(PES)

CE



EN 1492-2

L m	H mm	WLL ton	€	📄	📱
0,5	60	3	8,20	1	081760010
1	60	3	15,00	1	081760020
1,5	60	3	21,70	1	081760030
2	60	3	28,00	1	081760040
2,5	60	3	34,50	1	081760050
3	60	3	42,00	1	081760060
4	60	3	56,00	1	081760080
5	60	3	70,00	1	081760100
6	60	3	84,00	1	081760120
8	60	3	111,00	1	081760160

8177

estropos redondos, cinzento, 4t
cinta em poliester de elevada resistência
(PES)

CE

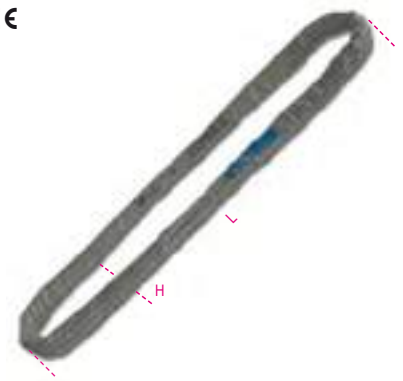

EN 1492-2

L m	H mm	WLL ton	€	📄	📱
0,5	65	4	16,40	1	081770010
1	65	4	17,70	1	081770020
1,5	65	4	26,00	1	081770030
2	65	4	34,00	1	081770040
2,5	65	4	43,00	1	081770050
3	65	4	51,50	1	081770060
4	65	4	67,50	1	081770080
5	65	4	84,00	1	081770100
6	65	4	101,00	1	081770120
8	65	4	134,00	1	081770160

8178

estropos redondos, vermelho, 5t
cinta em poliester de elevada resistência
(PES)

CE

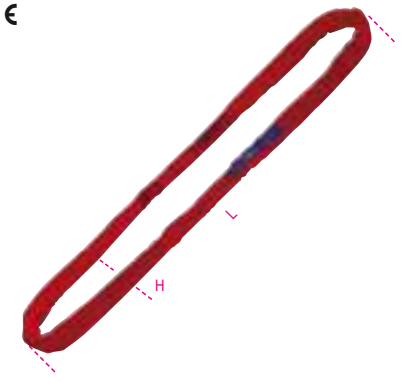

EN 1492-2

L m	H mm	WLL ton	€	📄	📱
0,5	70	5	22,00	1	081780010
1	70	5	26,00	1	081780020
1,5	70	5	32,50	1	081780030
2	70	5	43,00	1	081780040
2,5	70	5	52,50	1	081780050
3	70	5	62,50	1	081780060
4	70	5	83,00	1	081780080
5	70	5	104,00	1	081780100
6	70	5	124,00	1	081780120
8	70	5	166,00	1	081780160

8179M

estropos redondos, castanho, 6t
cinta em poliéster de elevada resistência
(PES)

CE

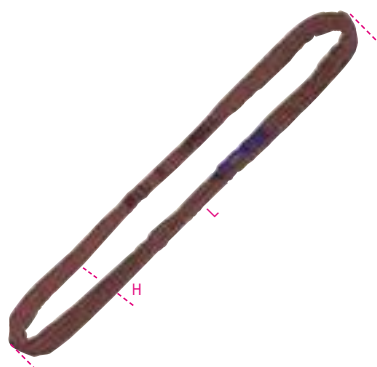

EN 1492-2

L m	H mm	WLL ton	€	🚚	🏠
1	80	6	28,00	1	081790020
1,5	80	6	40,50	1	081790030
2	80	6	53,50	1	081790040
2,5	80	6	66,00	1	081790050
3	80	6	77,00	1	081790060
4	80	6	103,00	1	081790080
5	80	6	130,00	1	081790100
6	80	6	154,00	1	081790120
8	80	6	205,00	1	081790160

8179B

estropos redondos, azul, 8 t,
em poliéster de elevada tenacidade (PES)

CE

EN 1492-2

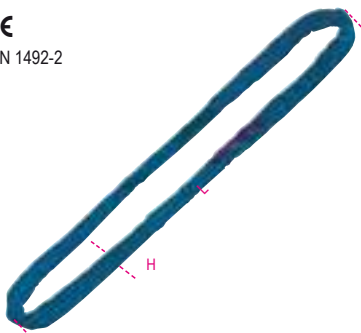

L m	H mm	WLL ton	€	🚚	🏠
1	85	8	35,00	1	081790220
1,5	85	8	53,50	1	081790230
2	85	8	71,00	1	081790240
2,5	85	8	88,00	1	081790250
3	85	8	102,00	1	081790260
4	85	8	136,00	1	081790280
5	85	8	175,00	1	081790300
6	85	8	204,00	1	081790320
8	85	8	271,00	1	081790360

8179A

estropos redondos, laranja, 10t+50t.,
em poliéster de elevada tenacidade (PES)

CE

EN 1492-2

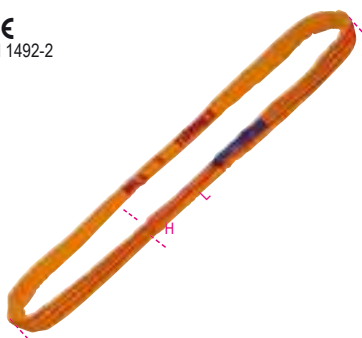

L m	H mm	WLL ton	€	🚚	🏠
1	95	10	53,50	1	081790502
1,5	95	10	73,00	1	081790503
2	95	10	104,00	1	081790504
2,5	95	10	121,00	1	081790505
3	95	10	160,00	1	081790506
4	95	10	208,00	1	081790508
5	95	10	234,00	1	081790510
6	95	10	309,00	1	081790512
8	95	10	378,00	1	081790516
10	95	10	520,00	1	081790520
12	95	10	555,00	1	081790524

2	100	12	161,00	1	081791204
2,5	100	12	191,00	1	081791205
3	100	12	219,00	1	081791206
3,5	100	12	248,00	1	081791207
4	100	12	278,00	1	081791208
4,5	100	12	281,00	1	081791209
5	100	12	336,00	1	081791210
5,5	100	12	366,00	1	081791211
6	100	12	394,00	1	081791212
6,5	100	12	424,00	1	081791213
7	100	12	453,00	1	081791214
7,5	100	12	481,00	1	081791215
8	100	12	510,00	1	081791216
8,5	100	12	540,00	1	081791217
9	100	12	570,00	1	081791218
9,5	100	12	600,00	1	081791219
10	100	12	630,00	1	081791220

2	110	15	199,00	1	081791504
2,5	110	15	234,00	1	081791505
3	110	15	266,00	1	081791506
3,5	110	15	301,00	1	081791507
4	110	15	334,00	1	081791508
4,5	110	15	367,00	1	081791509
5	110	15	399,00	1	081791510
5,5	110	15	435,00	1	081791511
6	110	15	468,00	1	081791512
6,5	110	15	505,00	1	081791513
7	110	15	535,00	1	081791514
7,5	110	15	570,00	1	081791515
8	110	15	605,00	1	081791516
8,5	110	15	640,00	1	081791517
9	110	15	670,00	1	081791518
9,5	110	15	710,00	1	081791519
10	110	15	735,00	1	081791520

2	130	20	235,00	1	081792004
2,5	130	20	276,00	1	081792005
3	130	20	317,00	1	081792006
3,5	130	20	356,00	1	081792007
4	130	20	398,00	1	081792008
4,5	130	20	438,00	1	081792009
5	130	20	479,00	1	081792010
5,5	130	20	520,00	1	081792011
6	130	20	560,00	1	081792012
6,5	130	20	600,00	1	081792013
7	130	20	640,00	1	081792014
7,5	130	20	685,00	1	081792015
8	130	20	725,00	1	081792016
8,5	130	20	765,00	1	081792017
9	130	20	805,00	1	081792018
9,5	130	20	845,00	1	081792019
10	130	20	890,00	1	081792020

2	135	25	260,00	1	081792504
2,5	135	25	310,00	1	081792505
3	135	25	362,00	1	081792506
3,5	135	25	411,00	1	081792507
4	135	25	464,00	1	081792508
4,5	135	25	515,00	1	081792509
5	135	25	565,00	1	081792510
5,5	135	25	620,00	1	081792511
6	135	25	670,00	1	081792512
6,5	135	25	720,00	1	081792513
7	135	25	770,00	1	081792514
7,5	135	25	820,00	1	081792515
8	135	25	875,00	1	081792516
8,5	135	25	925,00	1	081792517
9	135	25	975,00	1	081792518
9,5	135	25	1.030,00	1	081792519
10	135	25	1.080,00	1	081792520

2	160	30	305,00	1	081793004
2,5	160	30	367,00	1	081793005
3	160	30	429,00	1	081793006
3,5	160	30	491,00	1	081793007
4	160	30	555,00	1	081793008
4,5	160	30	620,00	1	081793009
5	160	30	680,00	1	081793010
5,5	160	30	740,00	1	081793011
6	160	30	805,00	1	081793012
6,5	160	30	865,00	1	081793013
7	160	30	925,00	1	081793014
7,5	160	30	990,00	1	081793015
8	160	30	1.050,00	1	081793016
8,5	160	30	1.110,00	1	081793017
9	160	30	1.170,00	1	081793018
9,5	160	30	1.240,00	1	081793019
10	160	30	1.300,00	1	081793020

2	165	40	424,00	1	081794004
2,5	165	40	473,00	1	081794005
3	165	40	550,00	1	081794006
3,5	165	40	630,00	1	081794007
4	165	40	710,00	1	081794008
4,5	165	40	785,00	1	081794009
5	165	40	865,00	1	081794010
5,5	165	40	940,00	1	081794011
6	165	40	1.020,00	1	081794012
6,5	165	40	1.100,00	1	081794013
7	165	40	1.170,00	1	081794014
7,5	165	40	1.260,00	1	081794015
8	165	40	1.330,00	1	081794016
8,5	165	40	1.410,00	1	081794017
9	165	40	1.490,00	1	081794018
9,5	165	40	1.560,00	1	081794019
10	165	40	1.640,00	1	081794020

3	180	50	640,00	1	081795006
3,5	180	50	730,00	1	081795007
4	180	50	820,00	1	081795008
4,5	180	50	905,00	1	081795009
5	180	50	995,00	1	081795010
5,5	180	50	1.090,00	1	081795011
6	180	50	1.170,00	1	081795012
6,5	180	50	1.260,00	1	081795013
7	180	50	1.350,00	1	081795014
7,5	180	50	1.440,00	1	081795015
8	180	50	1.530,00	1	081795016
8,5	180	50	1.610,00	1	081795017
9	180	50	1.700,00	1	081795018
9,5	180	50	1.800,00	1	081795019
10	180	50	1.880,00	1	081795020

 Robur

 Robur

8166

revestimento anti-abrasão para estropo, poliéster de elevada resistência (PES), com camada interior elastómero



H mm	ø mm	L m	€	📄	📦
70	45	3	22,80	1	081660073
80	52	3	27,00	1	081660083
110	70	3	32,50	1	081660103
155	100	3	68,50	1	081660153
170	110	3	75,50	1	081660170
235	150	4	205,00	1	081660235

H mm	📄	📦	📄
70	8150	8170-8173	081660073
80	8153	8176	081660083
110	8153-8156	8177-8178	081660103
155	8157	8178-8179A 8179B-8179M	081660153
170	8158	-	081660170
235	8159	-	081660235

8090F

elos para estropos em poliéster, liga de aço de elevada resistência

CE

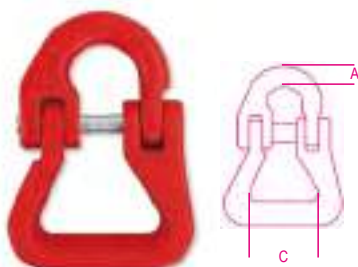

EN 1677-1

CARACTERÍSTICAS TÉCNICAS

- factor de segurança: 4
- tratamento térmico: endurecido e temperado
- código de identificação

TESTES LABORATORIAIS

- análise química, análise metalográfica
- ensaio de carga (WLL x 2.5)
- ensaio de tracção
- teste de fadiga (min. 20.000 ciclos)

CERTIFICADOS DISPONÍVEIS

- Especificações técnicas
- Relatório de ensaio UNI EN10204 tipo 2.2
- Certificado de inspeção UNI EN10204 tipo 3.1
- Declaração de Conformidade CE

WLL kg	📄	A mm	C mm	€	📄	📦
2000	7-8	10,5	40	28,00	1	080900220
3150	10	12	50	35,00	1	080900232
5300	13	17	60	54,00	1	080900253
8000	16	21	75	82,50	1	080900280

ESTICADOR COM SISTEMA DE ROQUETE coeficiente 2:1

em conformidade com UNI EN 12195
CARACTERÍSTICAS TÉCNICAS

- factor de segurança: 2
 - código de identificação
- ### TESTES LABORATORIAIS
- teste pré-tensionamento do roquete
 - teste deformação de componentes metálicos
 - ensaio de tracção sistema completo

CERTIFICADOS DISPONÍVEIS

- Especificações técnicas
- Relatório de ensaio UNI EN10204 tipo 2.2

8180

esticador com clique e gancho

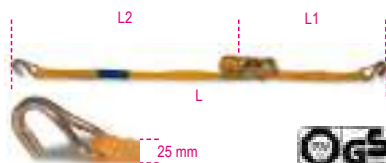

EN 12195-2

L m	L2 mm	L1 mm	STF daN	€	📄	📦
4	3750	250	200	13,40	1	081800004
6	5750	250	200	15,50	1	081800006
8	7750	250	200	17,40	1	081800008

LC = 750 kg

8181

esticador com clique e gancho

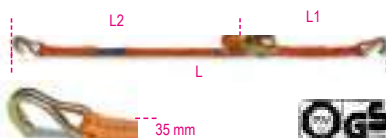

EN 12195-2

L m	L2 mm	L1 mm	STF daN	€	📄	📦
4	3600	400	180	16,40	1	081810004
6	5600	400	180	18,70	1	081810006
8	7600	400	180	20,50	1	081810008

LC = 1000 kg

81816/S4

kit de 4 esticadores, LC 1000 kg,
com mochila impermeável em poliéster

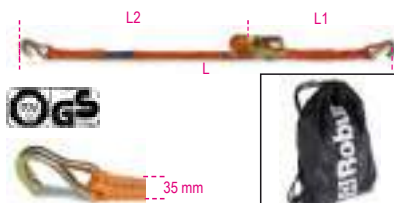

EN 12195-2

L mm	L1 mm	L2 mm	STF daN	€	📄	📦
6	400	5600	180	82,50	1	081810906

8181S

cintas de roquete com gancho duplo, LC 1000 kg,
em poliéster de elevada resistência (PES)

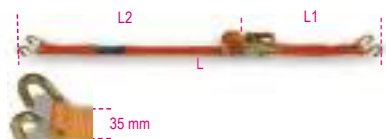

EN 12195-2

L m	L2 mm	L1 mm	STF daN	€	📄	📦
6	5600	400	180	18,20	1	081810206

LC = 1000 kg

8182E

esticador com clique para o interior de
carrinhas e veículo pesados,
LC 1000 kg,
em poliéster muito resistente (PES)

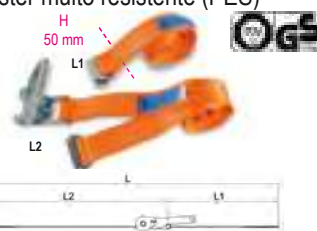

EN 12195-2

L m	L2 mm	L1 mm	STF daN	€	📄	📦
4	3500	500	220	18,70	1	081820440

LC = 1000 kg

	L2 mm	L1 mm	€	📄	📦
8182EL 2500	2500		5,80	1	081820942
8182EC 1500	1500		12,40	1	081820945

8182T

Esticador com clique e 2 ganchos, LC 1500kg,
cinta em poliéster de alta resistência (PES)

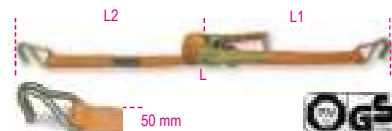

EN 12195-2

L m	L2 mm	L1 mm	STF daN	€	📄	📦
8,5	8100	400	300	29,00	1	081821085
10,5	10100	400	300	31,50	1	081821105

LC = 1500 kg

8182TS

Esticador com clique e gancho, LC 1500kg,
cinta em poliéster de alta resistência (PES)

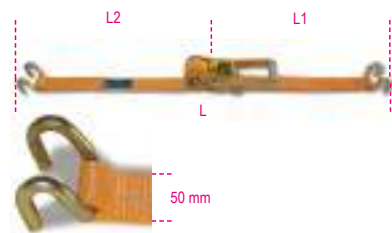

EN 12195-2

L m	L2 mm	L1 mm	STF daN	€	📄	📦
8,5	8100	400	300	30,00	1	081821285
10,5	10100	400	300	33,50	1	081821305

LC = 1500 kg

8182

esticador com clique e gancho

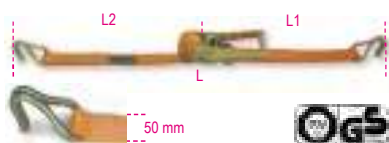

EN 12195-2

L	L2	L1	STF	€		
m	mm	mm	daN			
4,5	4100	400	300	26,00	1	081820045
6,5	6100	400	300	30,50	1	081820065
8,5	8100	400	300	33,00	1	081820085
10,5	10100	400	300	38,00	1	081820105
14,5	14100	400	300	42,50	1	081820145
16,5	16100	400	300	49,00	1	081820165

LC = 2000 kg

	L2	L1	€		
	mm	mm			
8182LP 8100	8100		18,20	1	081820902
8182SP 400		400	18,70	1	081820905

8182 8,5/S2

kit de 2 esticadores, LC 2000 kg, com mochila impermeável em poliéster

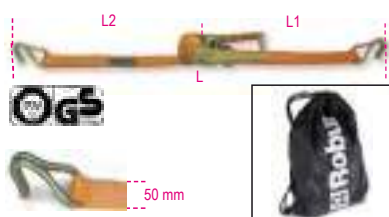

EN 12195-2

L	L1	L2	STF	€		
mm	mm	mm	daN			
8,5	400	8100	300	74,50	1	081821985

8182S

esticador com clique e 2 ganchos

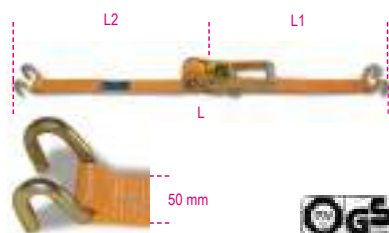

EN 12195-2

L	L1	L2	STF	€		
m	mm	mm	daN			
6,5	400	6100	300	30,00	1	081820265
8,5	400	8100	300	34,00	1	081820285
10,5	400	10100	300	38,00	1	081820305

LC = 2000 kg

	L2	L1	€		
	mm	mm			
8182SLP 8100	8100	-	17,80	1	081820912
8182SSP 400		400	18,20	1	081820915

8182GD

esticador com clique e gancho delta, LC 2000 kg, em poliéster de elevada resistência (PES)



EN 12195-2

L	L2	L1	STF	€		
m	mm	mm	daN			
8,5	8100	400	300	39,50	1	081820485

LC = 2000 kg

8182A

cintas de roquete com 2 olhais, em poliéster de elevada resistência (PES), LC 2000 kg



EN 12195-2

L	L2	L1	STF	€		
m	mm	mm	daN			
8,5	8100	400	300	34,00	1	081820585

LC = 2000 kg

8182H

Esticador com clique e gancho, LC 2000kg, cinta em poliéster de alta resistência (PES)

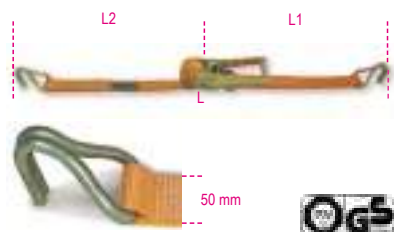

EN 12195-2

L	L2	L1	STF	€		
m	mm	mm	daN			
6,5	6100	400	300	33,50	1	081820406
8,5	8100	400	300	36,50	1	081820408
10,5	10100	400	300	40,00	1	081820410
14,5	14100	400	300	50,50	1	081820414

LC = 2500 kg

8182H/2

esticador com clique e 2 ganchos, LC 2500 kg, em poliéster de elevada resistência (PES)

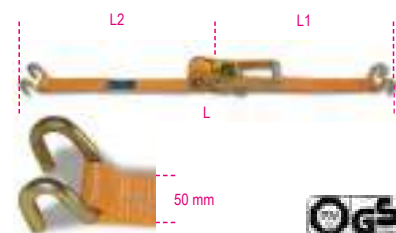

EN 12195-2

L	L1	L2	STF	€		
m	mm	mm	daN			
8,5	8100	400	300	38,50	1	081820385

LC = 2500 kg

8184

esticador com alavanca longa, um gancho, LC 2500 kg, cinta em poliéster de alta resistência (PES)



EN12195-2

L	L2	L1	STF	€		
m	mm	mm	daN			
6,5	6100	400	500	37,50	1	081840065
8,5	8100	400	500	39,00	1	081840085
10,5	10100	400	500	42,00	1	081840105

LC = 2500 kg

8183

esticador com gancho, LC 5000 kg, cinta em poliéster muito resistente (PES)



EN 12195-2

L	L2	L1	STF	€		
m	mm	mm	daN			
8,5	8000	500	500	106,00	1	081830085
12,5	12000	500	500	126,00	1	081830125

LC = 5000 kg

Robur

8190

Tensor de correntes com roquete e 2 ganchos
Grau 8



EN12195/3

CARACTERÍSTICAS TÉCNICAS

- fator de segurança: 2
- tratamento térmico: endurecido e temperado

código de identificação

CERTIFICADOS DISPONÍVEIS

- Especificações técnicas
- Relatório de ensaio UNI EN10204 tipo 2.2
- Certificado de inspeção UNI EN10204 tipo 3.1

Ø mm	LC daN	Ø mm	LC daN	€		
10	6300	8	4000	77,50	1	081900010
13	10000	-	-	121,00	1	081900013

* ATENÇÃO: O produto pode ser utilizado com uma corrente de 8 mm, desde que a Tensão Máxima de Utilização seja reduzida (LC 4000 daN)

8190B

correntes de fixação

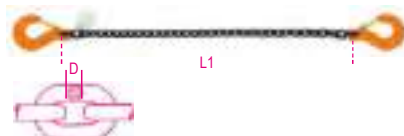

EN12195/3

CARACTERÍSTICAS TÉCNICAS

- fator de segurança: 2
- tratamento térmico: endurecido e temperado

etiqueta de identificação

CERTIFICADOS ANEXOS

Certificado do fabricante

CERTIFICADOS DISPONÍVEIS

- Relatório de ensaio UNI EN10204 tipo 2.2
- Especificações técnicas

Ø mm	LC daN	L m	L1 m	€		
8	4000	3,5	3,30	191,00	1	081901308
10	6300	3,5	3,28	290,00	1	081901310
13	10000	3,5	3,23	424,00	1	081901313



8185

esticador com clique e olhal



EN 12195-2

L m	STF daN	€		
5	200	11,10	1	081850005
8	200	13,40	1	081850008

8186

esticador com clique e olhal



EN 12195-2

L m	STF daN	€		
5	180	13,40	1	081860005
8	180	17,10	1	081860008

8187

esticador com clique e olhal



EN 12195-2

L m	STF daN	€		
5	350	24,60	1	081870005
8	350	29,00	1	081870008

8188C

esticador circular de aperto com sistema de roquete, LC 750 kg, correia em poliéster de elevada tenacidade (PES)

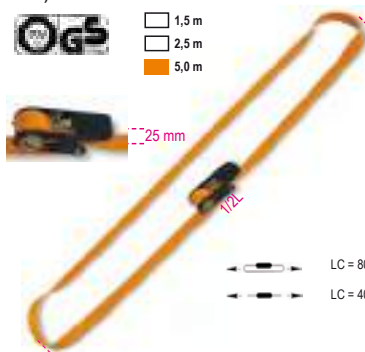

EN 12195-2

L m	STF daN	€		
1,5	72	4,40	3	081880315
2,5	72	5,30	3	081880325
5	72	6,60	3	081880350

8188CG/25

esticador com sistema de roquete 2 ganchos e furos, LC 400 kg, correia em poliéster de elevada tenacidade (PES)



EN 12195-2

L m	L1 mm	L2 mm	STF daN	€		
3	480	170	120	9,90	1	081880430
5	480	170	120	10,70	1	081880450



8188CU/25

esticador com sistema de roquete e ganchos, LC 400 kg, correia em poliéster de elevada tenacidade (PES)

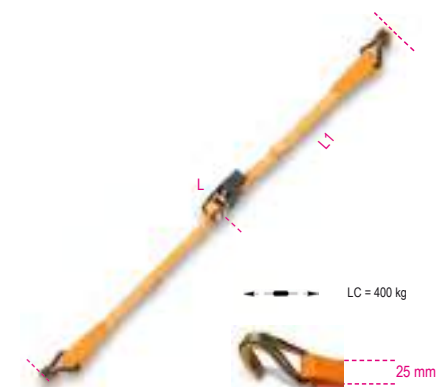

EN 12195-2

L m	L1 mm	L2 mm	€	U	U
5	300	4700	10,10	1	081880750

8188F

esticador circular de aperto, LC 200 kg, correia em propileno (PP) de elevada tenacidade

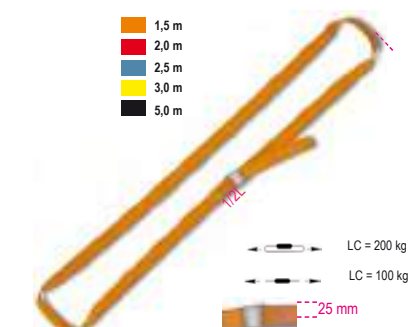

EN 12195-2

L m	€	U	U
1,5	2,52	10	081880215
2,0	2,70	10	081880220
2,5	3,00	10	081880225
3,0	3,20	10	081880230
5,0	4,10	6	081880250

8188F35

esticador circular de aperto, LC 500 kg, de elevada resistência, cinta em polipropileno (PP)



EN 12195-2

L m	€	U	U
5	9,20	1	081880295

8188FG2

esticador circular de aperto com 2 ganchos e furos, LC 250 kg, correia em poliéster de elevada tenacidade (PP)



EN 12195-2

L m	L1 mm	L2 mm	€	U	U
3	450	110	13,10	1	081881530

8188/K8

kit esticadores com 8 acessórios



8188/K8	€	U	U
	38,50	1	081880801

8488K	0,65m - 7kg
8488K	0,80m - 7kg
8188CL	4m - 500kg
8188FP	2,5m - 250kg

8189

correia em poliéster (PES) para esticadores



H mm	L m	LC kg	€	U	U
25	100	750	89,00	1	081890902
35	100	1000	113,00	1	081890903
50	100	2000	181,00	1	081890905

8189A

tapete antiderrapante para fixação de cargas



L m	H mm	S mm	U	€	U	U
5	250	8	0,6	62,00	1	081890525

8189PA

2 resguardos angulares para cintas de poliéster

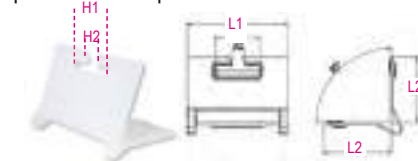

L1xL2 mm	H1 mm	H2 mm	€	U	U
135x90	60	18	3,90	1	081890090

Robur

Artigo	Relatório de teste 2.2 (UNI EN 10204)	Certificado de teste 3.1(UNI EN 10204)	Certificado do Fabricante	Declaração de Conformidade CE
8001Z	✓	✓		✓
8001TZ	✓	✓		✓
8002ZD	✓			
8003ZD	✓			
8004ND	✓			
8005Z	✓			✓
8005TZ	✓			✓
8006Z	✓			✓
8007Z	✓			✓
8008N	✓			✓
8008TZN	✓			✓
8009FD	✓			
8009Z	✓			✓
8009TZ	✓			✓
8010Z	✓			✓
8010TZ	✓			✓
8011Z	✓			✓
8011TZ	✓			✓
8015	✓		✓	✓
8016	✓			✓
8016DA	✓			✓
8016FR	✓			
8016U2	✓		✓	✓
8016UGK	✓		✓	✓
8018E	✓			
8018T	✓			
8020A	✓			
8021A	✓			
8025	✓	✓		✓
8026A	✓	✓		✓
8026R	✓	✓		✓
8028	✓	✓		✓
8029R	✓	✓		✓
8031R	✓	✓		✓
8032	✓	✓		✓
8040EN	✓	✓		✓
8040EZ	✓	✓		✓
8042EN	✓	✓		✓
8042EZ	✓	✓		✓
8041	✓	✓		✓
8043	✓	✓		✓
8044	✓	✓		✓
8048	✓			
8049	✓	✓		✓
8049A	✓	✓		✓
8049V	✓	✓		✓
8051S	✓	✓		✓
8052	✓	✓		✓
8057R	✓	✓		✓
8058R	✓	✓		✓
8060R	✓	✓		✓
8061R	✓	✓		✓
8062	✓	✓		✓
8063	✓	✓		✓
8063SL	✓	✓		✓
8064S	✓	✓		✓
8065SC	✓	✓		✓
8068S	✓	✓		✓
8074	✓			
8074A	✓			
8074G	✓			
8080	✓			
8080FM	✓			
8085R	✓	✓		✓
8086	✓	✓		✓

Artigo	Relatório de teste 2.2 (UNI EN 10204)	Certificado de teste 3.1(UNI EN 10204)	Certificado do Fabricante	Declaração de Conformidade CE
8090	✓	✓		✓
8090F	✓	✓		✓
8090R	✓	✓		✓
8091			✓	✓
8091SL			✓	✓
8092			✓	✓
8092SL			✓	✓
8094			✓	✓
8094SL			✓	✓
8096			✓	✓
8096SL			✓	✓
8097			✓	✓
8097SL			✓	✓
8098			✓	✓
8098SL			✓	✓
8100	✓	✓		✓
8105	✓	✓		✓
8109	✓	✓		✓
8110	✓			
8114	✓			
8116	✓			
8120 - 8120D	✓			
8120B	✓			
8121MZC	✓			
8134	✓		✓	✓
8135	✓		✓	✓
8143	✓		✓	✓
8146	✓		✓	✓
8146C	✓		✓	✓
8147C-S-P	✓		✓	✓
8148	✓		✓	✓
8149	✓		✓	✓
8150	✓		✓	✓
8153	✓		✓	✓
8156	✓		✓	✓
8157	✓		✓	✓
8158	✓		✓	✓
8159	✓		✓	✓
8160	✓		✓	✓
8161	✓		✓	✓
8166	✓			
8170	✓		✓	✓
8173	✓		✓	✓
8176	✓		✓	✓
8177	✓		✓	✓
8178	✓		✓	✓
8179M-B-A	✓		✓	✓
8180	✓			
8181	✓			
8181S	✓			
8182	✓			
8182A-GD	✓			
8182E	✓			
8182H-H2	✓			
8182M	✓			
8182S	✓			
8182T	✓			
8182T-TS	✓			
8182TS	✓			
8185	✓			
8186	✓			
8187	✓			
8188C	✓			
8188CG/25	✓			
8188CU	✓			

Artigo	Relatório de teste 2.2 (UNI EN 10204)	Certificado de teste 3.1(UNI EN 10204)	Certificado do Fabricante	Declaração de Conformidade CE
8188F	✓			
8188VF/35	✓			
8188FG2	✓			
8190	✓	✓		
8190B	✓		✓	
8302Z	✓			
8303Z	✓			
8317DZ	✓			
8317SZ	✓			
8381SL	✓			
8381SP	✓			
8383C	✓			
8383P	✓			
8515V	✓			
8515Z	✓			
8531	✓			
8532	✓			
8535	✓			
8201T	✓			
8205	✓			
8206	✓			
8207	✓			
8209	✓			
8210	✓			
8210F	✓			
8210FTP	✓			
8216	✓			✓
8220	✓			
8225	✓			
8227	✓			
8228	✓			
8240	✓			
8240F	✓	✓		✓
8242	✓			
8242F	✓	✓		✓
8248	✓			
8249	✓			
8249G	✓			
8250	✓			
8264	✓			
8267	✓			
8272	✓			
8273	✓			
8274	✓			
8274A	✓			
8274G	✓			
8276	✓			
8276G	✓			
8278	✓			
8280	✓			
8282	✓			
8282S	✓			
8284	✓			
8285	✓			
8286	✓			
8287	✓			
8290	✓			
8293	✓			
8297C	✓			
8297F	✓			
8381SX	✓			
8702...	✓	✓		
8709...	✓	✓		



Beta
Collection

Uma gama de produtos exclusivos, concebidos e desenvolvidos para reafirmar o carácter da BETA, que envolve mais de 200 artigos originais e de elevado nível: artigos de desporto, vestuário técnico e uma variada gama de artigos de recreação e promocionais. Um meio ideal para acções de promoção e imprescindível para os momentos de recreação e lazer.



9500TL

Casaco Softshell, 100% poliéster, 320g/m², revestimento externo triplo (3 camadas) em microfibra, impermeável, respirável, forrado a lã.



	€		
S	193,00	1	095000051
M	193,00	1	095000052
L	193,00	1	095000053
XL	193,00	1	095000054
XXL	193,00	1	095000055

9501TL

camisola de senhora, em algodão (80%) e poliéster (20%), 320 g/m²



	€		
S	94,00	1	095010061
M	94,00	1	095010062
L	94,00	1	095010063
XL	94,00	1	095010064

9501TL

Camisola de algodão (80%) e poliéster (20%), 320g/m²



	€		
S	110,00	1	095010051
M	110,00	1	095010052
L	110,00	1	095010053
XL	110,00	1	095010054
XXL	110,00	1	095010055

9502TL

Polo de manga curta, pique algodão 100%, 210g/m²



	€		
S	65,00	1	095020051
M	65,00	1	095020052
L	65,00	1	095020053
XL	65,00	1	095020054
XXL	65,00	1	095020055

9503TL

T-shirt 100% algodão jersey, 160 g/m²



	€		
S	42,50	1	095030051
M	42,50	1	095030052
L	42,50	1	095030053
XL	42,50	1	095030054
XXL	42,50	1	095030055

9504TL

casaco com exterior 100% poliéster, tratamento impermeável



	€		
S	131,00	1	095040051
M	131,00	1	095040052
L	131,00	1	095040053
XL	131,00	1	095040054
XXL	131,00	1	095040055

9505TL

colete com exterior 100%, tratamento impermeável, acolchoado 150 g/m², bolso interior



	€		
S	161,00	1	095050051
M	161,00	1	095050052
L	161,00	1	095050053
XL	161,00	1	095050054
XXL	161,00	1	095050055

9572LB

t-shirt Beta-March, 100% algodão jersey, 200 g/m² laranja, com inserts pretos



	€		
S	51,00	1	095720801
M	51,00	1	095720802
L	51,00	1	095720803
XL	51,00	1	095720804
XXL	51,00	1	095720805

9510W

camisa stretch, manga comprida, 120 g/m², 97% algodão, 3% elastano. Branca, com logo preto. Costas com duas pregas laterais, gola semi-francesa. Botões brancos, dois botões de punho. Slim fit



	€		
XS	118,00	1	095100100
S	118,00	1	095100101
M	118,00	1	095100102
L	118,00	1	095100103
XL	118,00	1	095100104
XXL	118,00	1	095100105

9534W0

polo com dois botões, em algodão jersey, 200 g/m², branco com inserts laranja



	€		
S	67,00	1	095340031
M	67,00	1	095340032
L	67,00	1	095340033
XL	67,00	1	095340034
XXL	67,00	1	095340035

9534B0

polo com dois botões, em algodão jersey, 200 g/m², azul com inserts cinza



	€		
S	67,00	1	095340071
M	67,00	1	095340072
L	67,00	1	095340073
XL	67,00	1	095340074
XXL	67,00	1	095340075

9537TL

pullover polar, 100% poliéster



	€		
S	64,00	1	095370051
M	64,00	1	095370052
L	64,00	1	095370053
XL	64,00	1	095370054
XXL	64,00	1	095370055



9580S

óculos de sol

CE



EN ISO 12312-1:2013+A1:2015
UV400
FILTER CAT. III

9580S € 35,50 1 095800100

9593S

smartwatch, ecrã tátil, rastreador de actividade física, bracelete em silicone



9593 S € 153,00 1 095930200

9593SB

pulseira de atividade multifunções, ecrã touch, monitorização de atividade física, frequência cardíaca, pedómetro, sono, com bracelete de silicone, preta

Compatibilidade: IOS 8.2 ou mais recente/ Android 4.4 ou mais recente
Bluetooth 4.2
IP67

CE



IP67

9593SB € 113,00 1 095930205

9593M

relógio automático, mostrador em aço, resistente à água 5 ATM, bracelete em aço



9593M € 372,00 1 095930120

9593A

Relógio analógico, caixa em aço, à prova de água até 5 ATM, bracelete em silicone



9593A € 295,00 1 095930050

9593W

Relógio analógico, caixa em plástico suave, aro em metal, à prova de água até 3 ATM, bracelete em silicone



9593W € 65,00 1 095930150



9544C

trolley tamanho de cabine com 4 rodas duplas, cadeado TSA, entrada USB + tomada 3.5-mm



9544C L 40 cm S 20 cm H 55 cm € 154,00 1 095440101

9557J 2.0

saco revestido a poliéster/Oxford 600D, dimensões 47x28x25 cm



9557J 2.0 L 47 cm S 25 cm H 28 cm € 91,50 1 095570020

9541F

mochila revestida a poliéster/Oxford 600D, dimensões 50x33x16 cm



9541F	L cm	S cm	H cm	€	1	095410011
	33	16	50	86,00		

9541PC

mochila de trabalho, estilo multi-bolsos, com compartimento interior para computador, 100% poliéster

- mochila com 3 compartimentos, cada um com fecho de correr exterior à prova de água
- primeiro compartimento com bolso para PC
- pega superior acolchoada
- porta USB
- bolso lateral em rede para garrafa/guarda-chuva
- inserção para óculos na alça de ombro
- faixa peitoral ajustável



9541PC	L cm	S cm	H cm	€	1	095410041
	34	18	52	74,50		

9541S

mochila em poliéster impermeável 210D, 33x45 cm



9541S	L cm	H cm	€	1	095410031
	33	45	11,60		

9541BIKE

mochila em poliéster Oxford, dimensões 41x24x16 cm



9541BIKE	L cm	S cm	H cm	€	1	095410021
	24	16	41	20,40		

95740

Luvas de trabalho, com punhos elásticos, reforço nos polegares e indicadores, em couro sintético sensível ao toque

CE



	€	1	095740202
M	39,50		
L	39,50		095740203
XL	39,50		095740204
XXL	39,50		095740205

9574B

Luvas de trabalho, com punhos elásticos, reforço nos polegares e indicadores, em couro sintético sensível ao toque

CE



	€	1	095740102
M	39,50		
L	39,50		095740103
XL	39,50		095740104
XXL	39,50		095740105

9525CM

boné camuflado, 100% poliéster, orifícios traseiros, estilo snapback



9525CM	€	1	095250098
	25,00		

9525TR

boné, 50% algodão, 50% poliéster, rede atrás, estilo snapback, preto



9525TR	€	1	095250011
	25,00		

9525WB

boné, 100% poliéster, com presilha de ajuste, branco



9525WB	€	1	095251032
	17,70		

9520P

suporte para guarda-chuvas, em metal galvanizado, com logotipo recortado a laser e tabuleiro apara-pingos, preto



9520P	€	1	095200100
	70,50		

9521

guarda-chuva, nylon T210, estrutura alumínio 3-seções, mecanismo automático de abertura/fecho



9521	€	1	095210000
	32,50		

95210B

guarda chuva nylon 210T, diâmetro 120 cm



95210B	100 cm	€ 36,00	1	095210021
--------	--------	---------	---	-----------

9599CB-N2

bicicleta de cidade Atala®, quadro Hi-Ten Tig TKK 700c, caixa de velocidades Shimano® Tourney RD-TZ50, 6 velocidades, travões V-Brake®, jantes em alumínio 28", com porta-bagagens, suporte e campainha, preto mate



9599CB-N2	€ 680,00	1	095990031
-----------	----------	---	-----------



9599CB-WN

bicicleta urbana Atala®, quadro em alumínio, caixa de velocidades Shimano® de 6 velocidades, travões V-Brake®, jantes 28" em alumínio, cinza

- Quadro em alumínio
- Garfo Hi-Ten Tig TKK 700c
- Caixa de velocidades Shimano Tourney RD-TZ50 6 velocidades
- Travões V-brake
- Jantes em alumínio 28"
- Cor: cinza



9599CB-WN	€ 680,00	1	095990024
-----------	----------	---	-----------

9598W-N

bicicleta de montanha Whistle®, quadro em alumínio, garfo Suntour XCT30, 29" 100 mm, caixa de velocidades Shimano RD-TX500, 7 velocidades, travões hidráulicos Shimano BR-M200 e 29" jantes em alumínio, laranja fluorescente / cinza antracite mate



9598W M-N	€ 1.170,00	1	095980130
9598W L-N	€ 1.170,00	1	095980132

9598WHP-N

bicicleta de montanha Whistle®, quadro em alumínio, garfo Suntour XCM PL, 29" 100 mm, com bloqueio remoto, caixa de velocidades Shimano XT RD-M8100 Shadow Plus, 12 velocidades, travões hidráulicos Shimano BL-MT201/BR-MT200 e 29" jantes em alumínio, branco / vermelho mate



9598WHP M-N	€ 2.180,00	1	095980140
9598WHP L-N	€ 2.180,00	1	095980142

9597TRIOWAY

sistema de propulsão auxiliar TRIOWAY by ATALA®, elétrico, pode ser acoplado à cadeira de rodas REHA COMFORT (incluída), bateria de lítio integrada na estrutura, guidador com controlos de direção e velocidade, com sistema de engate da cadeira de rodas integrado

CE



ESTRUTURA

- Sistema de engate/desengate rápido para cadeira de rodas com alavanca
- Estrutura rebatível com dobradiça dupla
- Guiador ajustável verticalmente
- Travão de disco, 180 mm
- Luz LED frontal
- Roda dianteira com pneu de borracha

DESEMPENHO

- Velocidade ajustável, até 15 km/h
- Botão avançar e retroceder
- Alcance: 20 km
- Acelerador de alavanca no guidador

BATERIA

- Bateria de lítio recarregável de 7Ah
- Bateria integrada na estrutura, amovível
- Cabo de carga 230V 50 Hz (incluído)

ACESSÓRIOS

- Ecrã multifunções, com capacidade residual da bateria e indicador de nível de carga
- Buzina
- Indicadores de direção
- Suporte para telemóvel (incluído)
- Botão ligar / desligar
- SISTEMA QUICK HOOK PRÉ-INSTALADO SOB A CADEIRA DE RODAS

CADEIRA DE RODAS REHA CONFORT (incluída)

- Estrutura rebatível com dobradiça dupla
- Rodas de 24" com pneus maciços em PU
- Apoios de braços amovíveis
- Estribos ajustáveis e amovíveis

DISPONÍVEL MEDIANTE SOLICITAÇÃO

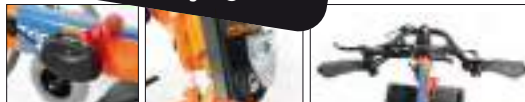

9597TRIOWAY

1 095970200



9539CB

capacete para ciclismo com protetor de queixo amovível - tamanhos ajustáveis



MEZURAS	€	U	U
S-M	180,00	1	095390010
L-XL	180,00	1	095390011

9542M

camisola de manga curta, tecido em microfibra respirável, fecho eclair longo coberto, três bolsos posteriores, um com fecho eclair, elástico em silicone na extremidade da camisola



MEZURAS	€	U	U
S	128,00	1	095420051
M	128,00	1	095420052
L	128,00	1	095420053
XL	128,00	1	095420054
XXL	128,00	1	095420055
XXXL	128,00	1	095420056

9542C

calções de ciclismo em lycra, elástico em silicone na extremidade das pernas, acolchoado de assento antibacteriano



MEZURAS	€	U	U
S	122,00	1	095420061
M	122,00	1	095420062
L	122,00	1	095420063
XL	122,00	1	095420064
XXL	122,00	1	095420065
XXXL	122,00	1	095420066

9542GW

Casaco, tecido respirável, corta vento, fecho eclair longo, elástico à volta da cintura, punhos de lycra, inserções refletoras traseiras, 3 bolsos traseiros exteriores, 1 com fecho



MEZURAS	€	U	U
S	222,00	1	095420101
M	222,00	1	095420102
L	222,00	1	095420103
XL	222,00	1	095420104
XXL	222,00	1	095420105
XXXL	222,00	1	095420106

9542G

camisola de inverno, tecido respirável, fecho eclair longo, três bolsos posteriores, elástico em silicone na extremidade da camisola



MEZURAS	€	U	U
S	128,00	1	095420012
M	128,00	1	095420013
L	128,00	1	095420014
XL	128,00	1	095420015
XXL	128,00	1	095420016
XXXL	128,00	1	095420017



9542S

calças interiores de inverno, em Lycra, acolchoado de assento antibacteriano e respirável



MEZURAS	€	U	U
S	172,00	1	095420022
M	172,00	1	095420023
L	172,00	1	095420024
XL	172,00	1	095420025
XXL	172,00	1	095420026
XXXL	172,00	1	095420027

9542AT

colete corta-vento, tecido respirável, fecho de correr longo



MEZURAS	€	U	U
S	103,00	1	095420072
M	103,00	1	095420073
L	103,00	1	095420074
XL	103,00	1	095420075
XXL	103,00	1	095420076
XXXL	103,00	1	095420077

9542AL

corta-vento impermeável, mangas compridas, em tecido respirável



	€		
S	164,00	1	095420042
M	164,00	1	095420043
L	164,00	1	095420044
XL	164,00	1	095420045
XXL	164,00	1	095420046
XXXL	164,00	1	095420047

9543C

gola multi usos, 100% microfibra de poliéster, sem costuras



	L cm	H cm	€		
9543C	25	50	9,00	1	095430100

9523T

garrafa térmica, em aço inox, 500 ml, tecnologia de camada dupla, sem ar entre as camadas, tampa anti-fugas, laranja

- mantém bebidas frescas durante 24 horas
- mantém bebidas quentes durante 12 horas



EC1935/EC2023

	ml	L mm	€		
9523T	500	255	22,50	1	095230050

9528B

garrafa em polietileno, 500 ml



	ml	€		
9528B	500	7,10	1	095280005

9597P

bomba de coluna com manómetro

- Adaptador para todos os tipos de válvulas de bicicletas (Schrader, Presta/Sclaverand, Regina)
- Máx. 12 bar/ 180 psi



	€		
9597P	66,00	1	095970100

9524SC

garagem Beta miniatura para colecionadores



	€		
1:18	94,00	1	095240018

9548KB

bicicleta de criança, quadro em alumínio, aros 12"; recomendada para crianças a partir dos 3 anos; peso máximo: 30 kg



	€		
9548KB	171,00	1	095480110

9548KB 20

bicicleta de montanha de criança Atala® 20", quadro em aço Hi-Ten Tig 20", garfo de suspensão 30 mm, caixa de velocidades RD-TY21SS 6V, travões V-brake em alumínio e jantes em alumínio 36 furos, amarelo fluorescente / azul mate



	€		
9548KB 20	550,00	1	095480120

9548KB 24

bicicleta de montanha de criança Atala® 24", quadro em aço Hi-Ten Tig 24", garfo de suspensão, caixa de velocidades Shimano Tourney RD-TYZ50 6V, travões V-brake em alumínio e jantes em alumínio 36 furos, laranja fluorescente mate



	€		
9548KB 24	585,00	1	095480122

9547WSK

bancada de trabalho com ferramenta "Kinder Work Station", para crianças a partir dos 3 anos de idade

CE



	H cm	€		
9547WSK	74	128,00	1	095473801

9547T

carro de ferramentas "Kinder", para crianças a partir dos 3 anos, completo com ferramentas

CE



	€		
9547T	69,50	1	095470100



9548G

"Mini Estação de Serviço", com 6 andares, com lavagem de carros, elevador e rampas



9548 G	H cm	69	€	69,50	1	095480100
--------	---------	----	---	-------	---	-----------

9561V 2,5

bandeira promocional 2.5x0.50 m com mastro em alumínio, base cruzada com anel de peso



9561V 2,5	L mt	0,50	H mt	2,5	€	250,00	1	095610200
-----------	---------	------	---------	-----	---	--------	---	-----------

9561VV 2,5

bandeira promocional 2.5x0.50 m com mastro



9561VV 2,5	L mt	0,50	H mt	2,5	€	225,00	1	095610201
------------	---------	------	---------	-----	---	--------	---	-----------

9561VV

Bandeira , 4x0.75 m



9561VV 4,0	L mt	0,75	H mt	3,50	€	370,00	1	095610101
------------	---------	------	---------	------	---	--------	---	-----------

9561V

bandeira de vela, 4x0.75 m, mastro de metal cromado, base em cimento, 50 cm



9561V	L mt	0,75	H mt	4	€	650,00	1	095610001
-------	---------	------	---------	---	---	--------	---	-----------

9559

faixa publicitária em TNT, em módulos de 3x0,8m



9559	L m	3	H m	0,8	€	30,00	1	095591001
------	--------	---	--------	-----	---	-------	---	-----------

9559/30MT

faixa publicitária com 10 logótipos BETA (30m)



9559/30MT	€	283,00	1	095591031
-----------	---	--------	---	-----------

9590B

bandeira em nylon, com impressão em serigrafia 40 x 215 cm



9590B	L cm	215	H cm	140	€	128,00	1	095900000
-------	---------	-----	---------	-----	---	--------	---	-----------



9577R

macacão de trabalho, estilo racing, em tecido stretch, 260 g/m², preto e laranja, com inserções refletoras e brancas

CE



	I	€	U	U
S	48	152,00	1	095770151
M	50	152,00	1	095770152
L	52	152,00	1	095770153
XL	54	152,00	1	095770154
XXL	56	152,00	1	095770155
XXXL	58	152,00	1	095770156

9579C

bata em poliéster/algodão



	€	U	U
M	67,00	1	095791002
L	67,00	1	095791003
XL	67,00	1	095791004

9565T

Mesa bidão em chapa de aço, com tampo em bétula envernizada

Fornecido com um KIT duplo de tubos de espaçamento (7cm ou 20cm) para ajuste vertical



9565T	H cm	Ø cm	€		
	95→108	70	500,00	1	095650200

9565S

Bidão em folha de aço, com assento em imitação de cabedal amovível



9565S	H cm	Ø cm	€		
	60	38	219,00	1	095650300

9565K

Mesa bidão com dois assentos



9565K	H cm	Ø cm	€		
	95	70	940,00	1	095650500

Beta

9563G

Cadeira de escritório



9563G	€		
	186,00	1	095630050

9563U

cadeira de escritório com braços, ergonómica



9563U	€		
	367,00	1	095630020

9549ABW

fonos wireless BT V5.0, com microfone, carga magnética, base de carga USB-C, preto

CE



9549ABW	L mm	H mm	S mm	€		
	61	34,5	41	33,50	1	095490091

9549SBW

altifalante BT sem fios, portátil, 6 funções

BT versão 5.0

FUNÇÕES:

- BT
- cartão TF
- USB
- audio jack 3.5 mm
- rádio FM
- chamada

CE



9549SBW	L mm	S mm	H mm	€		
	73	73	124	46,50	1	095490072

9549BP

bateria portátil, 10000mAh



9549BP	€		
	23,90	1	095490052

9549CR

cabo de carregamento 4 em 1, em nylon trançado, com opção de carregamento rápido

- Conector USB tipo A
- Conector iluminação para dispositivos Apple
- Conector de carregamento Micro USB
- Conector de carregamento USB-C
- Conector de carregamento e transmissão de dados USB-C



9549CR	L mm	€		
	120	17,90	1	095490042

9549MPC

base de carregamento multi-portas, 6 portas USB, para múltiplos carregamentos até uma potência de entrada máx. de 65 W

- 4 portas USB, 5V 2.4A
 - 1 porta USB, Q.C 3.0
 - 1 porta USB-C, 20W PD
- com interruptor ON/OFF separado, monitor LED para verificar potência total, número de portas e intensidade da corrente

CE



9549MPC	L mm	S mm	H mm	€		
	110	72	35	57,00	1	095490082

Beta

9549BRW

base de carregamento sem fios,
com função de carregamento rápido e
indicador do nível de carga

- Fornecida com cabo USB-USB Tipo C para ligação a transformador, 1 m comprimento
- Compatível com todos os dispositivos de carregamento sem fio
- Potência entrada: DC 5V/2A, 9V/2A, 12V/1.5A
- Potência saída: 5W/ 7.5W/ 10W/ 15W

CE



9549BRW	Ø mm	H mm	€	1	095490100
	58	6	32,50		

9549C

pen USB, 32 GB



9549C	€	1	095490062
	21,10		

9547

calculadora de mesa

CE



9547	€	1	095470000
	21,20		

9594

relógio com termómetro e higrómetro,
26 cm de diâmetro



9594	Ø cm	€	1	095940051
	26	31,50		

9526F

mini frigorífico, classe de eficiência energética
F, capacidade 63 l, preto

CE



9526F	€	1	095260005
	555,00		

9526P

máquina de café expresso com capsulas

Compatível com capsulas Lavazza™ e Espresso Point™
para utilização profissional



9526P	€	1	095260010
	360,00		

9527 6T

conjunto de 6 chávenas de café



9527 6T	€	1	095270001
	103,00		

9522A

abre garrafas com punho ergonómico



9522A	€	1	095220010
	18,00		

9523A

garrafa de alumínio, 500ml

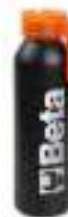

9523A	ml	€	1	095230005
	500	12,40		

9586K

faca multiusos,
10 funções



9586K	€	1	095860100
	17,30		

9526RMN

jogo de 2 baralhos de 55 cartas Modiano®



9526RMN	€	1	095260010
	30,00		

9592B/C50

kit de 50 canetas



9592B/C50	€	1	095920050
	51,50		

9592B/P

canetas personalizadas



9592B/P	€	500	095920051
	1,54		

9592MB

caneta Parker®



9592MB	€	1	095920060
	83,50		

Beta
QUALITY TOOLS

9592M/50

Conjunto de 50 lápis



9592M/50 € 51,50 1 095920100

9588M

tabuleiro em espuma macia com 1 caneta e 2 blocos de notas



9588M € 21,80 1 095880011

9596

correia porta-chaves/telemóvel em poliéster, com mosquetão metálico e cordão para telemóvel



9596 € 5,20 10 095961001

9595C

porta-chaves em pele



9595C € 9,40 1 095950011

Beta

9595T

porta-chaves em metal cromado, numa bolsa de veludo



9595T € 7,90 1 095950021

9569P

saco, em polietileno, lados dobrados



9569P L cm 34 H cm 44 € 0,84 50 095691001

9569S

sacos TNT, 38x42 cm, pegas longas



9569S L cm 38 H cm 42 € 2,57 50 095690051

9569MS-2

saco, em polipropileno rígido



9569MS-2 L cm 45 H cm 40 € 6,80 5 095690055

9569MS

saco, em polipropileno



9569MS L cm 60 H cm 40 € 6,80 5 095690052

9587 9x14

bloco de notas, 9x14 cm



9587 9X14 L cm 9 H cm 14 € 14,00 5 095870009

9587 13x21

bloco de notas, 13x21 cm



9587 13X21 L cm 13 H cm 21 € 17,90 5 095870013

Beta

9588S/10...

10 jogos de blocos de notas



9588S/10A	€ 30,00	1	095881001
21x29 cm			
9588S/10B	€ 28,50	1	095881002
15x21 cm			
9588S/10C	€ 18,60	1	095881003
10x15 cm			
9588S/10D	€ 13,40	1	095880054
7,5x10,5 cm			

9588/10PI

10 jogos de blocos de notas com folhas adesivas



9588S/10PI	€ 28,00	1	095880055
7,5x7,5 cm			

9589A/36

pack de 36 rolos de fitas adesivas com logótipo Beta



9589A/36	€ 144,00	1	095890035
----------	----------	---	-----------

9589B/36

pack de 36 rolos de fitas adesivas com logótipo Beta, brancas



9589B/36	€ 144,00	1	095890036
----------	----------	---	-----------

9562TB

tapete para experimentar sapatos, com parte de trás antiderrapante em borracha



9562TB	L mm 800	H mm 600	€ 49,50	1	095620500
--------	----------	----------	---------	---	-----------

9562T2

tapete para bancada de trabalho, 200x160 cm

- protege o chão de derrames de óleo e combustível, respeita o meio ambiente
- limpeza fácil, parte de trás antiderrapante em borracha



9562T2	L cm 200	H cm 160	€ 248,00	1	095620200
--------	----------	----------	----------	---	-----------

9562T1

tapete para oficina, 100x80 cm

particularmente adequado para utilização com BETA 3071 e 3071B

- borracha antiderrapante de limpeza fácil



9562T1	L cm 100	H cm 80	€ 91,00	1	095620150
--------	----------	---------	---------	---	-----------

9562T3

tapete para oficina
Dimensões: 300x160 cm

- particularmente adequado para utilização sob motocicletas
- protege o chão de derrames de óleo e combustível, respeita o meio ambiente
- limpeza fácil, parte de trás antiderrapante em borracha



9562T3	L cm 300	H cm 160	€ 360,00	1	095620300
--------	----------	----------	----------	---	-----------

9562P2

tapete para oficina, 200x80 cm

- particularmente adequado para utilização com o equipamento de oficina C55 ou sob motocicletas



9562P2	L cm 200	H cm 80	€ 174,00	1	095620400
--------	----------	---------	----------	---	-----------

9562P12

tapete para oficina, 12 m x 80 cm

Permite personalizar o comprimento conforme necessário



9562P12	L m 12	H cm 80	€ 880,00	1	095620425
---------	--------	---------	----------	---	-----------



ARTIGOS ELIMINADOS - ARTIGOS DE SUBSTITUIÇÃO/RECOMENDADOS

	ARTIGO ELIMINADO
	ARTIGO DE SUBSTITUIÇÃO
	ARTIGO RECOMENDADO

96AS 5/8	000960736		
96AS 3/4	000960738		
97BTX 50	000970150		
97BTX 55	000970155		
98XZN 14	000980014		
98XZN 16	000980016		
310/1	003100001		
310/C4	003100104		
353N	003530201		
353NM 10	003530210		
353NM 12	003530212		
353NM 14	003530214		
353NM 16	003530216		
353NM 18	003530218		
353NM 22	003530222		
353N/C6	003530300		
386A/3	003860003	386A/1	003860001
386A/4	003860004	386A/2	003860002
386A3/RC	003860013	386A1/RC	003860011
386A4/RC	003860014	386A2/RC	003860012
412 C3,00	004120288		
412 C3,25	004120289		
412 C3,50	004120290		
412 C4,00	004120292		
412 C4,50	004120294		
412 C5,00	004120296		
412 C5,50	004120298		
412 C6,00	004120300		
412 C6,50	004120301		
412 C7,00	004120302		
412 C7,50	004120303		
412 C8,00	004120304		
415 C3,00	004150288		
415 C3,25	004150289		
415 C3,50	004150290		
415 C4,00	004150292		
415 C4,50	004150294		
415 C5,00	004150296		
415 C5,50	004150298		
415 C6,00	004150300		
415 C6,50	004150301		
415 C7,00	004150302		
415 C7,50	004150303		
415 C8,00	004150304		
420A M3	004200003		
420A M4	004200004		
420A M5	004200005		
420A M6	004200006		
420A M8	004200008		
420A M10	004200010		
420B M3	004200053		
420B M4	004200054		
420B M5	004200055		
420B M6	004200056		
420B M8	004200058		
420B M10	004200060		
437K/10	004370030		
666N/2	006660002	666/2	006660702
666N/2X	006660003	666/2X	006660703
666N/5	006660005	666/5	006660705
666N/10	006660010	666/10	006660710
666N/10X	006660011	666/10X	006660711
666N/20	006660020	666/20	006660720
666N/30	006660030	666/30	006660730
666N-LBF.IN/5	006660055		
666N-LBF.IN/10	006660070		

666N-LBF.IN/10X	006660071		
666N-LBF.IN/20	006660072		
666N-LBF.IN/30	006660073		
666HS/5	006664005	666ZR-HS/5	006664705
666HS/10	006664010	666ZR-HS/10	006664710
666HS/20LC	006664021	666ZR-HS/20LC	006664721
666HS/30LC	006664031	666ZR-HS/30LC	006664731
667N/20	006670020	667/20	006670720
667N/30	006670030	667/30	006670730
667N/40	006670040	667/40	006670740
956L 20,8	009560221		
960S 22	009600022		
960T/D	009600035		
960T/E	009600036		
960T/I	009600040		
960T/L	009600041		
960T/M	009600042		
960BT/B 29	009600128		
960AVL	009600210		
960CMB	009600250		
960CMB/R2	009600252		
960CMD	009600270		
960CMD/R1	009600271		
960BC 25	009600285		
960BC 27	009600287		
960BC/P 28	009600288		
960BC 29	009600289		
960BC 30	009600290		
960EPC	009600790		
960SN 11	009600837		
960SN 12	009600838		
1044F 250	010440015	1044N 250	010440025
1044 250	010440250	1044N 250	010440025
1044FK 250	010449015	1044NK 250	010449025
1044K 250	010449250	1044NK 250	010449025
1134A/RL	011340145		
1150MQ 160	011500096	1150MQ 160	011500496
1150MQ 180	011500098	1150MQ 180	011500498
1150MQ 200	011500100	1150MQ 200	011500500
1150MQ 220	011500102	1150MQ 220	011500502
1229LP 1,0	012290210		
1229LP 1,2	012290212	1257LP 1,2	012570012
1229LP 1,4	012290214		
1229LP 1,8	012290218	1257LP 1,8	012570018
1229LP 2,0	012290220	1257LP 2,0	012570020
1229LP 2,4	012290224		
1229LP 3,0	012290230	1257LP 3,0	012570030
1229PH 0	012290250	1257PH 0	012570063
1229PH 1	012290251	1257PH 1	012570066
1366S	013660000	1366SH	013660400
1366S-KIT	013660001		
1438DCT	014380300		
1461C5G	014610053		
1461C6B	014610063		
1461C6G	014610064		
1461C7B	014610072		
1461C8B	014610083		
1461C9B	014610092		
1461C11A	014610111		
1461C12A	014610123		
1461C13B	014610134		
1461C18B	014610182		
1461C29B	014610209		
1461C20G	014610221		
1461C21G	014610222		
1461C23B	014610224		
1461C24B	014610225		
1461C25G	014610226		
1461C27G	014610228		
1461C28B	014610229		
1461C30G	014610231		

1461/C32G	014610233		
1461/C33B	014610234		
1462/KD	014620060		
1462/KMRC	014620070		
1462PIM	014620502		
1468N/1	014680011		
1468N/2	014680012		
1468N/3	014680013		
1478/3P	014780151		
1486/10	014860110		
1486/20	014860120		
1486/30	014860130		
1486/40	014860140		
1486/50	014860150		
1486/60	014860160		
1486/70	014860170		
1486/80	014860180		
1486/90	014860190		
1493 68-L14	014930206		
1493 75/77-L15	014930212		
1493 76-L8	014930214		
1493 95-L15	014930244		
1493AL 94,5-L15	014930345		
1493AL/CF 27	014930427		
1498TC	014980450		
1696A 800	016960108		
1716Q	017160010		
1739B	017390151	1739C	017390152
1740A	017400101	1740AN	017400103
1742	017420001	1742N	017420002
1742/C4	017420005	1742N/C4	017420006
1742KR M3	017420043	1742N/KR M3	017420063
1742KR M4	017420044	1742N/KR M4	017420064
1742KR M5	017420045	1742N/KR M5	017420065
1742KR M6	017420046	1742N/KR M6	017420066
1742A	017420100	1742AN	017420101
1742A/C	017420105	1742AN/C	017420106
1742A/KR M5	017420143	1742AN/KR M5	017420155
1742A/KR M6	017420144	1742AN/KR M6	017420156
1742A/KR M8	017420145	1742AN/KR M8	017420158
1742A/KR M10	017420146	1742AN/KR M10	017420160
1751NR	017510110		
1752 700	017520007		
1752R	017520020		
1753 200	017530002		
1753 300	017530003		
1753 500	017530005		
1753 700	017530007		
1753R	017530020		
1755 30	017550003		
1755 80	017550008		
1755 150	017550015		
1834RR	018340520		
1840BM	018400101		
1882	018820010	1882N	018820110
1883	018830035	1883N	018830036
1889	018890200	1889N	018890220
1915B 11X16	019150013		
1915C 11X16	019150016		
1915D 11X16	019150018		
1927PAL	019270009		
1946T	019460021	1946	019460001
1949BC/RU	019490122	1949BC/RUL	019490123
1972/12	019720012	1972/K12V-10	019720112
1984/18QM	019840018	1984/K600	019840060
2009ID	020090103	2109MT ID/1	021091026
2032TEL/A	020321314		
2051N	020510215	2051N	020510225
2258-O	022580011	2258N-O	022580021
TV250	024000408		
TV290	024000455	TV294	024000491
TV255	024000467		

ARTIGOS ELIMINADOS - ARTIGOS DE SUBSTITUIÇÃO/RECOMENDADOS

	ARTIGO ELIMINADO
	ARTIGO DE SUBSTITUIÇÃO
	ARTIGO RECOMENDADO

TV79	024000490		
TV121	024000767	TV122	024000768
T13	024240013		
T53	024240053		
T57	024240057		
T79	024240079		
T121	024240121	T122	024240122
T250	024240250		
T256	024240256		
T285	024240285	T279	024240279
T289	024240289	T294	024240294
T289	024240289	M294	024500294
TV57	024249907		
TV13	024249913		
M285	024500285		
M289	024500289		
MV115	024510115	MV116	024510116
MV285	024510285		
MV289	024510289	MV294	024510294
MM61	024580061		
MM140	024580141		
MMV61	024590061		
MMV142	024590142		
3008	030080100	3008N	030080110
3025	030250001	3025N 1,0	030250110
3025/PF	030250011	3025N/PF	030250111
3025/RF	030250901		
3025/RG	030250902		
3027 10	030270010	3027N 10	030270101
3027 20	030270020	3027N 20	030270102
3027 30	030270030	3027N 30	030270103
3027 50	030270050	3027N 50	030270105
3027 100	030270100	3027N 100	030270110
3027/KP10	030270510	3027N/KP10-20	030270511
3027/KP20	030270520	3027N/KP10-20	030270511
3027/KP30	030270530	3027N/KP30	030270531
3027/KP50	030270550	3027N/KP50	030270541
3027/KP100	030270551	3027N/KP100	030270552
3027/KPP50	030270555	3027N/KPP50	030270565
C45LMP	045000320	5000 RSC50/PLED	050001714
C54S-G	054000302		
C54S-R	054000303		
C55C	055000400		
C58M/PA	058000350		
5910VG/3T	059101068		
5945VU/M	059451001	5945VUM	059451011
5980ID	059801085	5980ID/1	059801086
C62M/W	062000360	C62M/WW	062000362
6200M/B	062000361		
7195A	071950004		
7200BKK 35	072000235		
7200BKK 36	072000236		
7200BKK 37	072000237		
7200BKK 38	072000238		
7200BKK 39	072000239		
7200BKK 40	072000240		
7200BKK 41	072000241		
7200BKK 42	072000242		
7200BKK 43	072000243		
7200BKK 44	072000244		
7200BKK 45	072000245		
7200BKK 46	072000246		
7200BKK 47	072000247		
7200BKK 48	072000248		
7201BKK 35	072010435		
7201BKK 36	072010436		

7201BKK 37	072010437		
7201BKK 38	072010438		
7201BKK 39	072010439		
7201BKK 40	072010440		
7201BKK 41	072010441		
7201BKK 42	072010442		
7201BKK 43	072010443		
7201BKK 44	072010444		
7201BKK 45	072010445		
7201BKK 46	072010446		
7201BKK 47	072010447		
7201BKK 48	072010448		
7210BKK 35	072100335		
7210BKK 36	072100336		
7210BKK 37	072100337		
7210BKK 38	072100338		
7210BKK 39	072100339		
7210BKK 40	072100340		
7210BKK 41	072100341		
7210BKK 42	072100342		
7210BKK 43	072100343		
7210BKK 44	072100344		
7210BKK 45	072100345		
7210BKK 46	072100346		
7210BKK 47	072100347		
7210BKK 48	072100348		
7212LG 34	072120134		
7212LG 35	072120135		
7212LG 36	072120136		
7212LG 37	072120137		
7212LG 38	072120138		
7212LG 39	072120139		
7212LG 40	072120140		
7212LG 41	072120141		
7212LG 42	072120142		
7214LN 34	072140134		
7214LN 35	072140135		
7214LN 36	072140136		
7214LN 37	072140137		
7214LN 38	072140138		
7214LN 39	072140139		
7214LN 40	072140140		
7214LN 41	072140141		
7214LN 42	072140142		
7216BKK 35	072160335		
7216BKK 36	072160336		
7216BKK 37	072160337		
7216BKK 38	072160338		
7216BKK 39	072160339		
7216BKK 40	072160340		
7216BKK 41	072160341		
7216BKK 42	072160342		
7216BKK 43	072160343		
7216BKK 44	072160344		
7216BKK 45	072160345		
7216BKK 46	072160346		
7216BKK 47	072160347		
7216BKK 48	072160348		
7224PEK 35	072240235		
7224PEK 36	072240236		
7224PEK 37	072240237		
7224PEK 38	072240238		
7224PEK 39	072240239		
7224PEK 40	072240240		
7224PEK 41	072240241		
7224PEK 42	072240242		
7224PEK 43	072240243		
7224PEK 44	072240244		
7224PEK 45	072240245		
7224PEK 46	072240246		
7224PEK 47	072240247		

7224PEK 48	072240248		
7225PEK 35	072250135		
7225PEK 36	072250136		
7225PEK 37	072250137		
7225PEK 38	072250138		
7225PEK 39	072250139		
7225PEK 40	072250140		
7225PEK 41	072250141		
7225PEK 42	072250142		
7225PEK 43	072250143		
7225PEK 44	072250144		
7225PEK 45	072250145		
7225PEK 46	072250146		
7225PEK 47	072250147		
7225PEK 48	072250148		
7235BK 35	072350335		
7235BK 36	072350336		
7235BK 37	072350337		
7235BK 38	072350338		
7235BK 39	072350339		
7235BK 40	072350340		
7235BK 41	072350341		
7235BK 42	072350342		
7235BK 43	072350343		
7235BK 44	072350344		
7235BK 45	072350345		
7235BK 46	072350346		
7235BK 47	072350347		
7235BK 48	072350348		
7239B 39	072390339		
7239B 40	072390340		
7239B 41	072390341		
7239B 42	072390342		
7239B 43	072390343		
7239B 44	072390344		
7239B 45	072390345		
7239B 46	072390346		
7239B 47	072390347		
7239B 48	072390348		
7248GK 35	072480235		
7248GK 36	072480236		
7248GK 37	072480237		
7248GK 38	072480238		
7248GK 39	072480239		
7248GK 40	072480240		
7248GK 41	072480241		
7248GK 42	072480242		
7248GK 43	072480243		
7248GK 44	072480244		
7248GK 45	072480245		
7248GK 46	072480246		
7248GK 47	072480247		
7248GK 48	072480248		
7293HN 39	072930839		
7293HN 40	072930840		
7293HN 41	072930841		
7293HN 42	072930842		
7293HN 43	072930843		
7293HN 44	072930844		
7293HN 45	072930845		
7293HN 46	072930846		
7293HN 47	072930847		
7294HN 39	072940839		
7294HN 40	072940840		
7294HN 41	072940841		
7294HN 42	072940842		
7294HN 43	072940843		
7294HN 44	072940844		
7294HN 45	072940845		
7294HN 46	072940846		
7294HN 47	072940847		

ARTIGOS ELIMINADOS - ARTIGOS DE SUBSTITUIÇÃO/RECOMENDADOS

	ARTIGO ELIMINADO
	ARTIGO DE SUBSTITUIÇÃO
	ARTIGO RECOMENDADO

7310CRK 35	073100335			
7310CRK 36	073100336			
7310CRK 37	073100337			
7310CRK 38	073100338			
7310CRK 39	073100339			
7310CRK 40	073100340			
7310CRK 41	073100341			
7310CRK 42	073100342			
7310CRK 43	073100343			
7310CRK 44	073100344			
7310CRK 45	073100345			
7310CRK 46	073100346			
7310CRK 47	073100347			
7310CRK 48	073100348			
7340B 36	073400236			
7340B 37	073400237			
7340B 38	073400238			
7340B 39	073400239			
7340B 40	073400240			
7340B 41	073400241			
7340B 42	073400242			
7340B 43	073400243			
7340B 44	073400244			
7340B 45	073400245			
7340B 46	073400246			
7340B 47	073400247			
7341N 36	073410236			
7341N 37	073410237			
7341N 38	073410238			
7341N 39	073410239			
7341N 40	073410240			
7341N 41	073410241			
7341N 42	073410242			
7341N 43	073410243			
7341N 44	073410244			
7341N 45	073410245			
7341N 46	073410246			
7341N 47	073410247			
7349RP 38	073490138			
7349RP 39	073490139			
7349RP 40	073490140			
7349RP 41	073490141			
7349RP 42	073490142			
7349RP 43	073490143			
7349RP 44	073490144			
7349RP 45	073490145			
7349RP 46	073490146			
7349RP 47	073490147			
7350RP 38	073500138			
7350RP 39	073500139			
7350RP 40	073500140			
7350RP 41	073500141			
7350RP 42	073500142			
7350RP 43	073500143			
7350RP 44	073500144			
7350RP 45	073500145			
7350RP 46	073500146			
7350RP 47	073500147			
7423 39/42	074230002			
7423 43/46	074230004			
7429 39/42	074290002			
7429 43/46	074290004			
7635N XS	076350500	7636N XS	076360500	
7635N S	076350501	7636N S	076360501	
7635N M	076350502	7636N M	076360502	
7635N L	076350503	7636N L	076360503	
7635N XL	076350504	7636N XL	076360504	
7635N XXL	076350505	7636N XXL	076360505	
7635N XXXL	076350506	7636N XXXL	076360506	
7658N S	076580001			
7658N M	076580002			
7658N L	076580003			
7658N XL	076580004			
7658N XXL	076580005			
7658N XXXL	076580006			
7904N XS	079040800	7750N XS	077500000	
7904N S	079040801	7750N S	077500001	
7904N M	079040802	7750N M	077500002	
7904N L	079040803	7750N L	077500003	
7904N XL	079040804	7750N XL	077500004	
7904N XXL	079040805	7750N XXL	077500005	
7904N XXXL	079040806	7750N XXXL	077500006	
7904N XXXXL	079040807	7750N XXXXL	077500007	
7907P XS	079070600			
7907P S	079070601			
7907P M	079070602			
7907P L	079070603			
7907P XL	079070604			
7907P XXL	079070605			
7907P XXXL	079070606			
7907P XXXXL	079070607			
7930G XS	079300300	7930MG XS	079300400	
7930G S	079300301	7930MG S	079300401	
7930G M	079300302	7930MG M	079300402	
7930G L	079300303	7930MG L	079300403	
7930G XL	079300304	7930MG XL	079300404	
7930G XXL	079300305	7930MG XXL	079300405	
7930G XXXL	079300306	7930MG XXXL	079300406	
7931G XS	079310300	7931MG XS	079310400	
7931G S	079310301	7931MG S	079310401	
7931G M	079310302	7931MG M	079310402	
7931G L	079310303	7931MG L	079310403	
7931G XL	079310304	7931MG XL	079310404	
7931G XXL	079310305	7931MG XXL	079310405	
7931G XXXL	079310306	7931MG XXXL	079310406	
7933G XS	079330300	7935MG XS	079350400	
7933G S	079330301	7935MG S	079350401	
7933G M	079330302	7935MG M	079350402	
7933G L	079330303	7935MG L	079350403	
7933G XL	079330304	7935MG XL	079350404	
7933G XXL	079330305	7935MG XXL	079350405	
7933G XXXL	079330306	7935MG XXXL	079350406	
7935G XS	079350300			
7935G S	079350301			
7935G M	079350302			
7935G L	079350303			
7935G XL	079350304			
7935G XXL	079350305			
7935G XXXL	079350306			
7939G XS	079390300			
7939G S	079390301			
7939G M	079390302			
7939G L	079390303			
7939G XL	079390304			
7939G XXL	079390305			
7939G XXXL	079390306			
7980N 58	079800058	7981N 58	079810158	
7980N 60	079800060	7981N 60	079810160	
7980R	079800111	7980RN	079800120	
7985	079850111	7985N	079850000	
8016FR-6K 3	080169753			
8016FR-4K 5	080169755			
8016FR-4K 6	080169756			
8016FR-4K 8	080169758			
8062 22-25	080620025			
8130A 10X900	081300209			
8131Z-8 6X800	081310060			
8131DL 10X900	081310209			
8135/KCA 0.75	081350630			
8135/KCA 1,0	081350635			
8135/KCA 2,0	081350640			
8135/KCA 3,0	081350645			
8135/KCA 5,0	081350650			
8135/KGF 0,75	081350705			
8135/KGF 1,0	081350710			
8135/KGF 2,0	081350720			
8135/KGF 3,0	081350730			
8135/KGF 5,0	081350750			
8135/KGM 0,75	081350805			
8135/KGM 1,0	081350810			
8135/KGM 2,0	081350820			
8135/KGM 3,0	081350830			
8135/KGM 5,0	081350850			
8139Z 8	081390008			
8139DL 14	081390214			
8139ZCH	081390909			
8149S/A	081490510			
8149S/B	081490512			
8149S/C	081490515			
9508TL S	095080051			
9508TL M	095080052			
9508TL L	095080053			
9508TL XL	095080054			
9508TL XXL	095080055			
9515M S	095150051			
9515M M	095150052			
9515M L	095150053			
9515M XL	095150054			
9515M XXL	095150055			
9515M XXXL	095150056			
9516B S	095160051			
9516B M	095160052			
9516B L	095160053			
9516B XL	095160054			
9516B XXL	095160055			
9516B XXXL	095160056			
9525TL	095250010	9525TR	095250011	
9525F	095250099	9525CM	095250098	
9525B	095251031	9525WB	095251032	
9527MUG	095270020	9599CB-WN	095990024	
9557N	095570001			
9565BBQ	095650100			
9565ICE	095650400			
9595 C25	095950031			
9599CB-W	095990023			
9599 GARAGE-S	095999011			
9599 GARAGE-M	095999012			
9599 GARAGE-L	095999013			
9599 GARAGE-XL	095999014			
9599 GARAGE-XXL	095999015			
C99T	099000492			
C99M	099000494			
C99T-V3	099000497			
C99P-V3	099000498			
11204C 40	112040204			
11204C 60	112040206			
11210C 40	112100204			
11210C 60	112100206			
11216C 40	112160204			
11216C 60	112160206			
11220C 40	112200204			
11220C 60	112200206			
11234B 40	112340104			
11234B 60	112340106			
11435 M-80	114350008			
11435 M-120	114350012			
11435 F-150	114350015			
11435 F-180	114350018			



Abocardador para tubos	32
Abraçadeiras	590÷593
Abraçadeiras em velcro	593
Acessórios para cabos Robur	671÷714
Acessórios para carros, gavetas e painéis	559÷561
Acessórios para tensores aço inox	700÷706
Alavancas / pés-de-cabra	123, 218, 309
Alicate de dobrar chapa	132
Alicate de furar chapa	132
Alicate para abraçadeiras em nylon	594
Alicate torce-arame com retorno automático	236
Alicate vazador	236
Alicates ajustáveis	129÷132, 289, 295, 310
Alicates de corte diagonal	133÷134, 289, 295, 301
Alicates de corte para electrónica	143÷144
Alicates de freios	128÷129, 173, 294÷295, 309
Alicates de pontas longas e extra-longas	127÷128, 140÷143, 289÷290, 296, 310
Alicates de pressão	130÷132, 193, 295
Alicates de rebitar e rebites	225÷227
Alicates de soldadura	253
Alicates e ferramentas para descarnar fio	138÷139
Alicates para cravar terminais	585÷587
Alicates para electrónica	142÷143
Alicates universais	139÷140, 289, 296, 310
Almofada insuflável de elevação	241
Almotolias	228÷229
Apalpa-folgas	219
Aparafusadora eléctrica EVOX-E	148
Aparafusadoras dinamométricas	60
Aparelhos de soldar	252÷253
Argolas de elevação	682÷685
Armários para ferramentas	402
Armários para ferramentas, chapa metálica	433÷435; 452; 473÷474
Aspiradores de líquidos e sólidos	325÷326
Bancadas de trabalho	401, 403÷409, 415÷420, 462÷464
Banco com rodas	262÷264
Barras dinamométricas	62, 66÷68
Baús para ferramentas	361, 363
Beta Abrasives	568÷584
Beta BM	588÷594
Beta Chemicals	562÷567
Beta Collection	715÷726
Bloqueante	564
Bloqueante	563
Bloqueante líquido	564
Bolsa para ferramentas com cinto	354÷355
Bomba de massa manual	227
Bomba dessoladora	252
Bomba manual para bidões	256
Bombas de massa	228
Bombas hidráulicas	163
Brocas cilíndricas	36÷40
Brocas cónicas	41
Brocas especiais para soldadores	41
Brocas para furar, roscar e escariar	47
Brocas, fresas craneanas e acessórios	51÷53
Buris	10
Busca-pólos	150



Caixa de velocidades	85
Caixas de ferramentas industriais	384÷385
Caixas para ferramentas	360÷363
Caixas para ferramentas portáteis	368÷370, 392
Calçado de segurança	624÷649
Câmara termográfica	236
Capas para blocos de ferramentas	393
Carro de ferramentas tipo trolley rebatível	367, 398
Carros para caixas de ferramentas	369
Carros para ferramentas	371÷380, 386÷394, 421÷422, 443÷444, 462÷465
Cerra cabos	678÷679
Cerra-cabos terminais	590
Chave de fendas angular	149
Chave de fendas com guia prensili	149
Chaves anti-faísca para válvulas de segurança	309
Chaves de abertura variável	24, 286, 293, 301, 307
Chaves de bocas simples e duplas	13÷15, 282, 286, 293, 305
Chaves de cachimbo 6 faces / 12 faces	112÷113, 294, 309
Chaves de caixa articuladas duplas	15
Chaves de caixa sextavadas com punho	113÷114, 288
Chaves de caixa sextavadas com punho em T para parafusos Torx®	114, 116÷117
Chaves de caixa tubulares	112÷113, 118
Chaves de caixa, acessórios e jogos, 1"	110÷111
Chaves de caixa, acessórios e jogos, 1/2"	99÷109, 288, 308
Chaves de caixa, acessórios e jogos, 1/4"	86÷93
Chaves de caixa, acessórios e jogos, 3/4"	109÷110, 308÷309
Chaves de caixa, acessórios e jogos, 3/8"	93÷99, 287÷288, 307
Chaves de fendas BetaEVOX	145÷148
Chaves de fendas BetaGrip	152÷156
Chaves de fendas BetamaX	157÷159
Chaves de fendas reversíveis	155÷156
Chaves de impacto, acessórios e jogos	70÷78
Chaves de luneta	15÷17, 286, 293, 305÷306
Chaves de luneta abertas	17
Chaves de luneta para parafusos de andaimes	17, 306
Chaves de pancada	14÷15, 305÷306
Chaves de parafusos com ponta de aço	149
Chaves de roquete	25÷27, 294
Chaves de tubos	33÷34, 294, 301, 307
Chaves de unha	23÷24, 307
Chaves e barras dinamométricas	57÷69
Chaves em T com 3 pontas macho sextavadas para parafusos Torx®	115÷117, 287, 309
Chaves macho sextavadas para parafusos Torx®	18÷23
Chaves macho sextavadas para parafusos Torx®, com punho	21÷23, 293, 301
Chaves macho sextavadas XZN®	23
Chaves mistas boca/luneta	11÷13, 25÷26, 294, 300, 305
Chaves para operadores de painéis de controlo	210
Chaves pé de galo quadra fêmea de 3/8"	96
Cola instantânea	565
Comparadores	212
Compassos	214
Conjunto de mala de ferramentas e acessórios	364÷367
Contador de litros digital para óleo	256
Conta-fios	218
Controlador de binário electrónico com transdutor Dynatester	69
Corta-cabos	138, 289
Corta-cabos - serviços pesados	135
Corta-parafusos	134, 310



Corta-tubos	28÷32, 307
Curva-tubos	34÷35
Desandadores de machos e caçonetes	46, 49
Desandadores de percussão	158÷159
Desbloqueador lubrificante em spray	565
Detergentes	566÷567
Diferencial de corrente manual	692÷693
Discos abrasivos	570÷572, 583
Discos lamelados	576÷580
Discos magnéticos de soldadura para elevação de chapas metálicas	253
Eixo anti-faísca	312
Elevadores para bicicletas	281÷282
Enrolador de cabo eléctrico com gambiarra fluorescente	314÷318
Enrolador de tubo para ar comprimido ou água fria	347
Escopros planos	10, 125, 218, 292, 300, 304, 312
Escovas	224÷225, 312
Espátulas	224, 312
Espelhos de inspecção	219
Esquadros	212÷213
Esteiras	263
Esticadores	706, 710÷713
Estropos de elevação	706÷709
Expositores para ponto de venda	610÷623; 669÷670
Extractor de fluídos	256
Extractor de fio de nylon	587
Extractor de porcas e parafusos	171÷172
Extratores	198÷204
Extratores de 2 pernas	198÷204, 208
Extratores de 3 pernas	200÷202, 208
Extratores de cones Morse	44
Extratores dos cubos e tambores de rodas	202÷203
Extratores hidráulicos	208
Ferramentas anti-faísca	304÷312
Ferramentas anti-queda	292÷298
Ferramentas eléctricas	313÷324
Ferramentas eléctricas	322÷325
Ferramentas em aço inox	299÷303
Ferramentas isoladas 1000V	285÷291
Ferramentas para bicicletas	280÷284
Ferramentas para canalizações	27÷35
Ferramentas para motociclos	274÷279
Ferramentas pneumáticas e acessórios	327÷350
Ferramentas sem fio	313÷321
Ferro de soldar tubos e uniões em plástico	27÷28
Ferro de soldar tubos e uniões em plástico de grandes dimensões	28
Ferros de soldar	250÷252
Fita de fricção	594
Fitas-métricas	215÷216
Fixadores magnéticos para soldadura	253
Furadores	220
Gama blister	595÷609
Ganchos de elevação	692
Goniómetros	213
Grampos	209
Grampos	209
Guarda-cabos	680, 702
Guinchos manuais e acessórios	694, 699
Holofote LED	244

Indicadores ângulo de aperto	61
Inserts 4mm	150
Jogos de ferramentas	479÷532
Jogos de ferramentas em módulos	533÷558
Kit reparação de plástico	166
Lanternas	242÷243
Lanternas / gambiarras	242÷247
Lápis de carpinteiro	215
Limas	161, 220÷224, 312
Lingas de corrente	685÷689
Lubrificador tipo caneta	229
Luvas isolantes	291
Machos manuais e jogos	44÷47
Machos, caçonetes e jogos	47÷51
Magnetizador/desmagnetizador	144
Mala para ferramentas tipo mochila	358
Malas para ferramentas	354÷361
Malas para ferramentas	351÷357, 364÷366
Malas para ferramentas tipo trolley	380÷382, 397÷400, 448, 469
Malas para ferramentas tipo trolley	355÷356, 359÷361, 395÷396
Malhos	169, 311
Manilhas direitas	680÷682
Manómetros para tubos de várias camadas	31
Marretas	169, 311
Martelos	162, 166÷169, 296÷297, 302, 310÷311
Martelos com batentes plásticos	169÷170, 297, 311
Máscara de soldadura	254
Massa lubrificante em spray	565÷566
Medidor de distância laser	215÷216
Medidor de raios	218
Micro-chaves de fealdas	150÷151
Micrómetros	211
Mobiliário para Oficina	410÷478
Módulos termo-formados para ferramentas	533÷558
Molas helicoidais em aço inoxidável	46÷47
Mós montadas abrasivas	573÷576
Mós montadas com lamelas em tela abrasiva de coríndon	581÷583
Multímetros	232÷233, 297
Multiplicadores de binário	54÷56
Navalhas	239÷240, 312
Níveis de bolha	216÷217
Óculos de protecção	669
Painéis para ferramentas	405, 430, 451, 470
Paquímetros	210÷211
Pás anti-faísca	312
Pesca peças magnético	219
Pesca-peças magnético	219
Picaretas anti-faísca	312
Pinça amperimétrica	234
Pinças	126÷127, 289
Pincéis	225
Pistola de óleo	256
Pistolas de ar quente	325
Pistolas de cola a quente	325
Pistolas de pintura	347
Pistolas para isolantes	227
Plataforma de carga eléctrica	398
Plataforma em alumínio	238



Pontas e porta-pontas	78÷85, 155, 287
Ponteiros para pedreiro	217
Postes de plástico com base de enchimento	668
Posto de trabalho móvel	383
Prensas hidráulicas para extratores	208
Produtos elétricos	585÷594
Punções	9
Punções	9, 304
Quebra-porcas	219
Raspadores	173, 184, 220, 239
Rebarba tubos	31
Réguas graduadas	214, 297
Reparação de veículos	118÷125, 160÷166, 170÷208, 229÷238
Revestimentos isolantes	594
Riscadores	215
Rolos antidesperdício	584
Saca-molas	224
Saca-troços	9, 278, 304
Serra para madeira	224
Serrote e folhas de serra	224
Silicone em spray	566
Sinais de alerta em alumínio	668
Spray de limpeza	566÷567
Spray descongelante	567
Spray impermeabilizante	567
Suporte de ferramentas magnético	238, 264
Suporte para chaves de impacto	333
Suporte para rolos de papel	377÷378
Suportes para garrafas	377÷378, 477
Tacómetro digital	235
Tacómetros ambientais	236
Talhadeira extra-plana com cortante direito	161
Tanques de limpeza ultrassónicos	260÷261
Tapete isolante	291
Tapete para bancada de trabalho	263, 276, 291, 409, 726
Tensores	672÷677
Terminais pré-isolados	589
Termómetros	235
Tesoura com roquete para tubos PVC	30
Tesouras	135÷136
Tesouras	136÷137, 241, 295, 312
Tesouras para eletricistas	136÷137, 289, 295
Tornos de bancada para tubos	35
Tornos magnéticos para soldadura	253
Tornos paralelos de bancada	209
Traçador de linhas	218
Transferidor de ângulos	213
Turquês para cofragens	134
Vazadores de juntas	135÷136
Vedante de roscas	563
Vedante de silicone	565
Ventosas	237
Verificador de tensão	193
Vestuário de trabalho	650÷670
Videoscópio electrónico	122
X-acto	238÷239
Zinco em spray	567

Automotive



Alavanca extracção do terminal braço oscilante da suspensão e amortecedores	207
Alavancas para carroçaria	161
Alavancas para pneus	122÷123, 283
Alicate de pressão com corrente para tubos de escape	182
Alicate para as molas de travões	178
Alicate para cavilhas	182
Alicate para oclusão de tubos	184
Alicates para abraçadeiras	179÷180
Alicates para agrafos de estofos auto	236
Alicates para anéis de segurança	173
Alicates para pesos de calibração	125
Alicates para remoção de assentos de válvulas	174
Alicates para remoção de relays	192÷193
Alicates para tampas de plástico da porca da roda	124
Alicates para uniões rápidas de tubos de combustível	185
Alicates para velas de ignição	181
Alinhadores de embraiagem	172
Apalpa folgas para bate-chapas	162
Aparelho de teste de baterias e sistemas de recarga	197÷198
Aparelho extracção do líquido de travões	177
Aparelho testes de fugas em sistemas de arrefecimento	231
Aparelhos de soldar por pontos, com rodas	164
Apoios telescópicos	238
Armações flexíveis com lima de chapeiro	161
Arrancadores	194÷195
Bancada móvel para manutenção de caixas de velocidades/transmissões	400
Barras de torção para porcas de rodas	77
Bomba manual para regulação e controlo de injectores Diesel	122
Capas para rodas	124
Carregadores de baterias	195÷197
Carro inferior para veículos	265
Chave para remoção braços de direcção	207
Chave para turbinas	182
Chaves de caixa para injectores de motores Diesel	119
Chaves de caixa para porcas de cubos de rodas	123
Chaves de caixa para sonda Lambda	119
Chaves de cruz para porcas de rodas	124
Chaves de gancho para molas	171
Chaves de impacto para porcas de rodas	72÷73
Chaves de impacto para porcas de rodas Isuzu	76
Chaves de pancada para rolamentos cónicos e vedantes	208



Chaves em T com cardan para velas	118÷119
Chaves para bóias dos depósitos de combustível	185
Chaves para bujões de óleo	191÷192
Chaves para filtros de óleo	187÷191
Chaves para filtros de óleo e gás	190
Chaves para injetores	174
Chaves para pernos de amortecedores de pesados	206
Chaves para sensores de temperatura	120÷121
Cintas para anéis de pistão	173
Compressómetro digital	175
Compressómetros para motores a gasolina e Diesel	122
Compressores de molas de válvulas	173
Compressores para molas de amortecedores	205
Densímetro para líquido anti-congelante, corpo em vidro	231
Densímetro para líquido das baterias, corpo em vidro	231
Depósito recolha de fluídos	255÷256
Destalonadores de pneus	346
Detetor de sinal	234
Elevador para rodas	266
Encontradores	160÷161
Escovas de aço para limpeza de terminais e bornes de baterias	225
Espátulas para reparação auto, em aço inoxidável	161
Estabilizadores de voltagem	198
Estação de carregamento automático para ar condicionado	259÷260
Estação de decapagem por jato de areia	261
Estação de limpeza componentes do motor	262
Estação de manutenção para caixas de velocidades automáticas	257÷259
Esteira para mecânico	263÷265
Estetoscópio	198
Extractor de rótulas homocinético	207
Extractores de injectores eléctricos common rail diesel	121
Extractores de rótulas	207
Extrator de juntas	203
Ferramentas fixação da polia da árvore de cames	175
Ferramentas para abertura e rebitagem de correntes	278
Ferramentas para air bags	172
Ferramentas para lavagem auto interior/exterior	255, 262, 346, 609
Ferramentas para válvulas	124÷125
Ferramentas para velas de ignição	181
Ferramentas remoção de conectores eléctricos	193
Ferramentas remoção de frisos das portas	237
Ferramentas remoção de silentblocks	208
Ferramentas remoção de velas de incandescência danificadas	121
Ferramentas remoção de vidros de automóveis	237
Ferramentas sistemas de ar condicionado	186

ÍNDICE PARA FERRAMENTAS DE VEÍCULOS AUTOMÓVEIS



Folhas de alumínio moldável	230
Funil em plástico	229÷230, 312
Grua hidráulica rebatível	267
Jogo escareadores para limpeza alojamento dos injectores	121
Jogo ferramentas para êmbolos de travões	178
Jogo ferramentas para extracção de auto-rádios	237
Jogo pinos-guia para rodas	124÷125
Jogos de ferramentas para embraiagens DSG	172
Kit para enchimento filtros de óleo diesel	184
Macaco e disp. posicionamento para rodas de pesados	266
Macaco hidráulico	273
Macacos de fossas hidráulico	267÷268
Macacos hidráulicos com rodas	271÷272
Macacos hidráulicos de garrafa	266
Manómetro para encher pneus	345÷346
Martelos com pena	162
Medidor rasto dos dos pneus	218
Paquímetros para discos e tambores de travões	210
Porta-paletes manual	273
Preguiça para motociclos	274÷275
Preguiças	266
Prensa hidráulica	269÷270
Protecção frontal para veículos	263
Punções para sensores de estacionamento	165÷166
Recuperadores de óleo	255÷256
Refletores de mossas com ventosa	163
Reservatório para líquidos de baterias	229
Retificador de válvulas pneumático	173
Suporte para motores	267
Tanque de limpeza de componentes	261÷262
Tira mossas pneumáticos	164
Tira-mossas	162÷164
Trolley multiusos	397
Verificador de tensão	193



ÍNDICE ALFANUMÉRICO

1		1010	128 1078	132 1122K	601 1150GBMK	602
		1010BM	128 1080D	132 1123	136 1150GK	602
100	24	1010MQ	289 1081	133 1123K	601 1150HPC	140
100/KIT	24	1031/S4	128 1082	133 1124	136 1150K	602
110BA	307	1032	128 1082BA	310 1124K	601 1150MQ	289
110MQ	286	1032BA	309 1082BM	133 1125	136 1153	140
111CM	24	1032K	600 1082BMK	600 1126	136 1162	140
111E	24	1033	128 1082G	133 1127	136 1162BA	310
111EN	24	1033K	600 1082GBM	133 1128BAX	136 1162BM	141
111ER	24	1034	128 1082GBMK	600 1128BM	137 1162BMK	602
120	25	1034K	600 1082GK	600 1128BMX	136 1162G	141
120/B6N	25	1034L	129 1082K	600 1128BMX/F	136 1162GBM	141
123/K4	25	1036	129 1082MQ	289 1128BMX	601 1162GBMK	602
123/K4	597	1036BA	309 1084	133 1128BSX	137 1162GK	602
123E1/4	25	1036K	600 1084BM	133 1128BSX	601 1162K	602
123Q1/2	25	1037	129 1084BMK	601 1128FX	137 1162MQ	289
123Q1/4	25	1037K	600 1084G	133 1128FXS	137 1164	141
123Q3/8	25	1038	129 1084GBM	133 1128MQ	289 1164BM	141
141	25	1038K	600 1084GBMK	601 1129BM	137 1164BMK	602
141/B	25	1039	129 1084GK	601 1129BMK	601 1164K	602
141/S	25	1044N	129 1084K	600 1130BMX	137 1164MQ	289
142	25	1044NK	600 1084MQ	289 1130BMX	602 1166	141
142/B	26	1046BA	310 1088	133 1131CK	137 1166BA	310
142/S	26	1047	129 1088BM	133 1132	138 1166BM	141
142/SC9I-E	26	1047BM	129 1088BMK	601 1132BM	138 1166BMK	603
142AS	26	1048BM	130 1088K	601 1132BMK	602 1166G	141
142AS/S	26	1048MQ	289 1088MQ	289 1132K	602 1166GBM	141
142C	26	1048N	130 1092V	134 1132MQ	289 1166GBMK	603
142C/A	26	1048N/D3	130 1094V	134 1133	138 1166GK	603
142K	597	1048NK	600 1095N	134 1133RL	138 1166K	602
142MC	26	1048VN	130 1096	134 1134	138 1166MQ	289
142MC/SC9I-E	26	1048VNK	600 1096K	601 1134A	138 1168	141
142SN	26	1050	130 1098	134 1134RL	138 1168BM	142
142SN/S	26	1051	130 1098K	601 1137BA	310 1168BMK	603
142SN/SC9	26	1051GM	130 1098PL	134 1137BA/RC	310 1168G	141
186	27	1051L	130 1098PLK	601 1142BM	138 1168GBM	142
187	27	1051XL	130 1100BA 600	310 1142BMK	602 1168GBMK	603
187/B5	27	1052	130 1101	134 1142MQ	289 1168GK	603
188	27	1052BA	310 1101R	134 1143	138 1168K	603
192	27	1052K	600 1102	134 1143R	138 1168MQ	290
192/S2	27	1053	131 1103	134 1144D	138 1169/D3	142
192/S2	597	1054	131 1103R	134 1144D/RG	138 1169BM/D3	142
194	27	1055	131 1104	135 1144D/RL	138 1169G/D3	142
195	27	1055D	131 1104R	135 1144G	138 1169GBM/D3	142
195/B5	27	1056	131 1105	135 1144G/RL	139 1169MQ/D2	290
195AS	27	1057A	131 1105/C10T	135 1144L	139 1169N/D4	142
195AS/B	27	1058	131 1105/C16T	135 1144T	139 1171BM	142
195K	597	1059	131 1105/C32T	135 1148A	139 1172BM	142
195P	27	1060	131 1105AD-50	135 1148A/R	139 1172BM/P	143
195P/B5	27	1061	131 1105T20	135 1148B	139 1173BM	143
1002	127	1062	131 1105T30	135 1148B/R	139 1175BM	143
1008	127	1062AL	132 1105T50	135 1148P	139 1177BM	143
1008BM	127	1062GM	132 1112	135 1149F	139 1177BM/Z	143
1009	127	1063	132 1112K	601 1149F	602 1178BM	143
1009L/A	127	1064	132 1114	136 1150	139 1178BM/P	143
1009L/B	127	1065F	132 1118	136 1150BA	310 1182BM	143
1009L/C	127	1065P	132 1120A	136 1150BM	140 1183BM	144
1009L/D	128	1066	132 1120ARL - ARG	136 1150BMK	602 1184BM	144
1009L/DP	128	1067	132 1122	136 1150G	139 1185BM	144
1009L/DP-S2	128	1077	132 1122 - 1125MOL	136 1150GBM	140	

ÍNDICE ALFANUMÉRICO

1186BM	144	1253A	150	1267TX/D7	155	1293BX/DA	614	1360G	162
1188BM	144	1254	150	1267TX/S13	155	1293BX/DD	614	1361/C12	162
1190BM	144	1254	604	1267TXK	604	1293BX/DE	614	1361/K9	162
1191BM	144	1256/20	150	1268RTX	155	1293BX/DF	614	1362B	163
1191BM/L	144	1256/30	150	1268RTX/S8	155	1293ES	158	1364SCP	163
1191R/5-M	144	1256/C36-2	150	1268RTXK	604	1293ES/S7	158	1364SE	163
1200MS	144	1256LP	150	1269N/PZ	155	1294	158	1364SP	163
1201E	145	1256PE	150	1269N/PZK	604	1294/S7	158	1364SR	163
1201E/DZ	146	1256PH	150	1269PZ	155	1294K	605	1364SV	163
1201E/K	603	1256PZ	150	1269PZ/S4	155	1294L	158	1365/K13	163
1201E/S6	145	1256RTX	150	1269PZK	604	1295	158	1365P10	163
1201EN	145	1256TX	150	1270BA	310	1295/C14	159	1366/K5	164
1201EN/K	603	1257BE	151	1272BA	310	1297TX	159	1366A	163
1202E	146	1257ES	151	1272MQ	290	1297TX/D6	159	1366B	164
1202E/K	603	1257ESB/S8	151	1272MQ/S	290	1297TX/L	159	1366KF	164
1202E/S4	146	1257LP	150	1272MQF	290	1297TX/L-S5	159	1366S/R1	164
1202EL	146	1257LP/S	151	1273MQ/D6	290	1297TX/S12	159	1366S/R10	165
1202EN	146	1257LPH/S8	151	1273MQ/E1	614	1298RTX	159	1366S/R11	165
1202EN/K	603	1257PH	151	1273MQ/E4	614	1298RTX/S8	159	1366S/R12	165
1203/E10P	612	1257TX	151	1273MQF/D6	290	1298RTXK	605	1366S/R13	165
1203/E1P	612	1257TX/S	151	1274MQ	290	1299N/PZ	159	1366S/R14	165
1203/E4P	612	1260	152	1274MQ/S	290	1299N/PZK	605	1366S/R2	164
1203/E5P	612	1260/S6	152	1274MQF	290	1299PZ	159	1366S/R21	165
1203E/D	146	1260E	153	1275MQ/C	290	1299PZ/S6	159	1366S/R22	165
1203E/S	146	1260EK	604	1276MQ/C	291	1299PZK	605	1366S/R24	165
1204E	146	1260K	604	1277BA	310	1302	160	1366S/R25	165
1204E/K	603	1260MC	153	1279MQ	291	1303	160	1366S/R26	165
1204E/S5	146	1260N	152	1279MQ/F	291	1304	160	1366S/R3	164
1204EL	147	1260NK	604	1279MQ/S	291	1305	160	1366S/R4	165
1205E/ES	147	1262	153	1281/B28A	156	1305Z	160	1366S/R5	165
1205E/ES-S8	147	1262/S4	153	1281BG	155	1306	160	1366S/R6	165
1206E/BP	147	1262E	153	1281BG/A9	156	1307	160	1366S/R7	165
1206E/BP-S7	147	1262EK	604	1281BG/B28NA	156	1308	160	1366S/R8	165
1207E TX/K	603	1262K	604	1281BG-TX/A8	156	1310	160	1366S/R9	165
1207E/TX	147	1262L	153	1281LP	155	1312	160	1366SH	164
1207E/TX-D	147	1262MC	153	1281LPH	156	1314	161	1366SH/C	164
1208E RTX/K	603	1262N	153	1281PB	155	1326	161	1366SL	164
1208E/RTX	147	1262NK	604	1281PE	156	1327	161	1366ST	164
1208E/RTX-D	147	1263/D...	153	1281PH	156	1328	161	1367/K10	166
1209E PZ/K	603	1263/E39	613	1281PM	155	1329	161	1367/K4	166
1209E/PZ	147	1263/E40	613	1281PZ	156	1330	161	1367/S4	165
1209E/PZ-S4	147	1263/E50	613	1281RTX	156	1331	161	1368	166
1209EN/PZ	147	1263/E62	613	1281TX	156	1335BM	161	1368G/C2U	166
1209EN-PZ/K	604	1263/E70	613	1290	157	1337/S5	161	1368G/CV	166
1210E/GE	148	1263/E74	612	1290/S	157	1338	161	1368G/K400	166
1211E/GE	148	1263/E78	612	1290K	605	1338A - 1338B	161	1368G/OD	166
1229LP/S	148	1263/E85	613	1290K/INOX	605	1338R9 - 1338R12	161	1368G/SD	166
1229LPH/A6	148	1263/S12	154	1290N	157	1342	161	1369/C11	167
1236B	149	1263MC/D8	154	1290NK	605	1342PM	161	1370	167
1238B	149	1264	154	1292	157	1342PMR	161	1370/MR...	167
1241	149	1264/S5	154	1292/S4	157	1343	161	1370BA	310
1242	149	1264K	604	1292K	605	1344	162	1370BA/MR	311
1243/D7	149	1264L	154	1292K/INOX	605	1344A/VW	162	1370BA/PL	311
1243/S11	149	1265ES	154	1292L	157	1345	162	1370F	167
1243LP/D6	149	1265ES/S8	154	1292N	157	1351	162	1370F/MR...	167
1250	149	1266BP	154	1292NK	605	1353	162	1370FT	167
1251	149	1266BP/S8	154	1293/D...	158	1357Z/45	162	1370T	167
1252/S5	149	1267MC/TX	155	1293/S...	158	1359T	162	1374F	167
1253	150	1267MC/TX-D7	155	1293BP	158	1360/K6	162	1374F/MR...	167
1253	604	1267TX	154	1293BP/S	158	1360/KP3	162	1375	168

ÍNDICE ALFANUMÉRICO

1375/MR	168	1435/1	172	1467T/C6	178	1477D/S5	182	1488/1	187
1375A	168	1435/1R	172	1467TU	178	1477K/7	182	1488R...	187
1375B	168	1435R	172	1470	178	1478	182	1489/31T	187
1375BA/PL	311	1437/C12	172	1470FT	178	1478/K3	183	1489/33	187
1376X	168	1438	172	1470PF	178	1478NSS	183	1489/33P	188
1376X/MR	168	1438DCT/S	173	1471	178	1478SP	183	1489/C14	188
1376XT	168	1438DSG	172	1471A	178	1478T	183	1489/E	188
1376XT/MR	168	1438EVO	172	1471CF	179	1479	183	1489/Y	188
1377	168	1438K/DSG-2	172	1471CM	179	1479/B27	183	1489R	188
1377/MR...	168	1438K/PWR	172	1471CM/E11	179	1479L/K4	183	1490	188
1377BA	311	1438R	172	1471D2	179	1479L/S2	183	1490/R1 - 1490/R2	188
1377BA/PL	311	1439/K7	173	1471GF	178	1479LB/C5	183	1490F	188
1377T	168	1440/...	173	1471M/50	178	1479LV/S3	183	1491	188
1378	168	1445/1 - 1445/2	173	1471M/C22	178	1479ML/B17	183	1491A	188
1378/MR...	168	1452K	173	1471M/P	178	1479ML/S3	183	1491R	188
1379BA	311	1452PN/K	173	1471M/W50	179	1479N/S5	184	1491T	188
1379F	168	1454P	173	1471PN/B1	179	1479RB/1	184	1492/1 - 1492/2	189
1379F/MR...	169	1455SVP	173	1471PN/B2	179	1479RB/2	184	1492T	189
1380	169	1455SVP/R...	173	1471PN/B3	179	1479RB/3	184	1493	189
1380/MR...	169	1457/B4	173	1471PN/B4	179	1479U/13	184	1493/C19	190
1380BA	311	1458	173	1471PN/B5	179	1479U/32	184	1493/C30	189
1380BA/MR	311	1460F	174	1471PT/C5	179	1480	184	1493/C7	190
1380BA/PL	311	1462/EI	174	1471T/C5	179	1481/C12	184	1493/PF	189
1380S	169	1462/KI	174	1472	179	1481K/S4	184	1493/S-U	191
1380S/MR...	169	1462/KU	174	1472AU	179	1481PL	184	1493AL	189
1380T	169	1462/MB	174	1472AU/P	180	1481PL/S3	184	1493AL 4S	189
1381	169	1462AD/BSC	174	1472AU/RP	180	1481T/C12	185	1493AL CF	190
1381/MR...	169	1462AD/SMN	174	1472B/RNLT	180	1482	185	1493B	189
1381BA	311	1462CF	174	1472FC	180	1482/8 - 1482/10	185	1493B/S5	189
1381BA/MR	311	1462CF/C6	174	1472FC/GE	180	1482A/1	185	1493C/ADB	191
1381BA/PL	311	1462CF-SN	174	1472FC/L	180	1482A/3	185	1493DSG	190
1381T	169	1462CF-SN/C6	174	1472FCA	180	1482A/5	185	1493FF	190
1385	169	1463/KIT	175	1472FCL/RP	180	1482B	185	1493FT	190
1385/MR	169	1464ADB	176	1472H	180	1482C	185	1493H	190
1390	169	1464AP	175	1472MT/VW	180	1482D	185	1493HK	190
1390/MR...	169	1464AP T	175	1472R/AU	180	1482SN	185	1493J	190
1390BA	311	1464AP T16X12	175	1472TM	180	1483K/12	185	1493U/ADB	191
1390BA/R	311	1464APB	176	1472VW	180	1483K/22	186	1493VW	190
1390N	170	1464CBD	175	1473	181	1483KV-PT/S7	81	1493X	191
1390NR	170	1464FAP	176	1473A	181	1484	186	1493Y	191
1390R	170	1464FG	176	1473FN	181	1484PSA	186	1494	191
1391	170	1464FG/CP4	176	1473P	181	1485/KIT	186	1494/C14A	192
1391A	170	1464IC	175	1473T	181	1485BP	186	1494BMW	191
1392	170	1464IC/RK	175	1474/C4	181	1485BPM	186	1494E	191
1392R	170	1464PB	176	1474DL	181	1485FCA/K2	186	1494FPC	191
1393	170	1464PF	177	1474E/VW	181	1485FCA/T	186	1494M	192
1410/M	171	1464PT	176	1474E/VW2	181	1485FCA/TS	186	1494MAN	191
1428	171	1464T	175	1474G	181	1485FRD/T	186	1494MRC	191
1428/SB11	171	1464T/SP80	175	1474L	181	1485MJ	187	1494Q	192
1428L	171	1464TDI	176	1475U	181	1485MRC/T	186	1494T	192
1428L/B3	171	1464VD	176	1476	182	1485PMTJ	187	1494T/C5	191
1429	171	1465	177	1476/RC	182	1485R	187	1494VW	191
1429/SB7	171	1466/C5	177	1476A	182	1485R/P10	187	1494VW/K	192
1430/...	171	1466L 11	177	1476A/RC	182	1485R/P17	187	1494VW/KT	192
1430/S	171	1466TLF	177	1476C/1	182	1485TC	186	1494XZN	192
1431/...	171	1467	177	1476GT	182	1485VAG	187	1495/C6	192
1431/C5	171	1467/RK1	177	1476PSA	182	1485VAG/K2	187	1495M	192
1433	171	1467/RK2	177	1476T	182	1485VLV/T	186	1495T	192
1433/C11	172	1467LF/2	177	1477/C10	182	1487/K2	187	1496/C	192
1435	172	1467LF/RC	177	1477D	182	1488 - 1488L	187	1497/C23	193

ÍNDICE ALFANUMÉRICO

1497/C94	193	1516/1 - 2 - 3	200	1565/1 - 2 - 3	207	1670	213	1703BA/A	312
1497/S3	193	1517	200	1566/GO1	207	1670A	213	1703BA/P	312
1497BS	193	1517C/...	201	1566N	207	1672	213	1703BA/PL	312
1497D	192	1518/...	201	1566P	207	1672A	213	1704	218
1497KB/S3	193	1518U/...	201	1566R	207	1674A	213	1704A	218
1497P	193	1519/...	201	1567	207	1674C	213	1704C	218
1497RC	193	1520/1 - 1520/2	202	1568	208	1676	213	1705	218
1497SS	193	1521/1 - 1521/2	202	1569/F	208	1678/C3	213	1705PT	218
1497TE	193	1528	202	1569/SB	208	1679	213	1706DGT	218
1498	193	1529	202	1569CP	208	1679/PR	213	1707	218
1498/12	195	1529/C7	202	1570/3	208	1680	214	1707A/1 - 2 - 3	218
1498/120A	197	1529/PG	202	1580/8I	208	1680A	214	1708/8 - 13 - 20	219
1498/12-24 R20	195	1529PI	202	1580GL	208	1680B	214	1709/10 - 1709/18	219
1498/16A	196	1530/C16	202	1585/5I - 6I - 7I	208	1680C	214	1710	219
1498/24	195	1530/C5	202	1585GI/5 - 6 - 7	208	1682	214	1712E/1 - 2 - 3	219
1498/25A	196	1531/C7	203	1589PI/50 - 100 - 150	208	1683	214	1712TF	219
1498/2A	195	1532	203	1589VI	208	1685/C7	214	1713M	219
1498/2A-8A-PR	196	1533/...	203	1590	209	1687/S4	214	1713M/K7	219
1498/40A	197	1533PR/1 - 2 - 3	203	1591	209	1687A	214	1714	219
1498/4A	195	1534/...	203	1593	209	1687AC	214	1715	219
1498/4A-8A CO	196	1535/C...	203	1594	209	1687D	214	1715B/R5L	219
1498/4A-8A CP	196	1539	203	1595	209	1687U	214	1715FL/A	219
1498/8A	196	1540	203	1599B	209	1688	215	1715FL/B	219
1498B12/R02	195	1542/1 - 1542/2	204	1599F	209	1688A	215	1715I	219
1498BC/12	194	1544/...	204	1599G	210	1688M	215	1715L	219
1498LT/12	194	1545/C5M	204	1599GI	209	1688PC	215	1715R/FL	219
1498LT/12-24	195	1547/C6	204	1599GR	209	1688PC/R	215	1716A	219
1498LT/12-R7	194	1547KP	204	1599P	209	1690F	215	1716P	220
1498LT/12-SF	194	1547P	204	1599T	209	1690L	215	1716R	220
1498MN/12-C	194	1547PC/2	204	1600Q 10	210	1691BM	215	1716U	220
1498MN/12-P	194	1547PL/2	204	1600Q 10	606	1691MG	215	1717A	220
1498MN/12-R	194	1549	204	1600Q 8	210	1692	215	1717B	220
1498MN/12-U	194	1550U	205	1600Q 8	606	1693	215	1717BA	312
1498PC	198	1550U/CGS-R	205	1602BA	312	1693	606	1717BA/1	312
1498SA/2A-4A	195	1550U/M	205	1603BK	606	1693L	215	1717C	220
1498SM	197	1550U/MRC-ABE	205	1603K	606	1693M	216	1717D	220
1498SM-A	197	1550U/MRC-C	205	1650	210	1694/L	216	1717T	220
1498SM-C	197	1550U/S...	205	1650FD	210	1694A/L	216	1717T RS	220
1498SM-CP	197	1550U/SS187	205	1650FT	210	1694B/L	216	1717T RT	220
1498ST/TB	198	1551/C20	205	1651DGTB	210	1695XS	216	1717V	220
1498ST/TB ROT	198	1552/C9	205	1651DGTB/IP	211	1696	216	1717V R	220
1498TB/12-24	198	1555/Q	206	1652	211	1696A	216	1718A...M	221
1498TB/6-12	197	1555/QS	206	1654	211	1696B	216	1718A...P	221
1499	198	1555C	206	1654DGT	211	1696D	217	1718A...Q	220
1500/...	198	1555S/BMW-RNT	206	1656	211	1696S	217	1718A...R	221
1500/SP	198	1556/1A	206	1657DGT/2	211	1697	217	1718A...S5	221
1500G/...	198	1556/2A	206	1658/...	211	1699L	217	1718A...T	221
1500N/...	198	1557	206	1658/C4	211	1699L/1	217	1718D...M	221
1500N/G...	199	1557/S3	206	1658DGTB	211	1699Q	217	1718D...P	221
1500N/SP	199	1557V	206	1658SP/1	212	1700N	217	1718D...Q	220
1501/1 - 2 - 3	199	1558/C13	206	1659	212	1700N/PM	217	1718D...R	221
1501G/1 - 2 - 3	199	1558/C4	129	1662/1 - 1662/2	212	1701_WARN	218	1718D...S5	221
1501Z/S - P - R	199	1558P	206	1662AN	212	1701BA	312	1718D...T	221
1502/...	199	1559	207	1662DGT/A	212	1701N	217	1719BA12	312
1505/C5	200	1559V/8T	207	1662SP0	212	1701N/PM	217	1719BA8	312
1505V	199	1560/2	207	1662SP2	212	1701NE/...	218	1719BM/RG	223
1506	200	1560A	207	1666	212	1701PMR	218	1719BM/RL	223
1508/1 - 1508/2	200	1561/...	207	1666A	212	1702N	218	1719BM/RP	223
1511/1 - 2 - 3	200	1562D	207	1668	212	1702N/PM	218	1719BM/RR	223
1515/1 - 2 - 3	200	1563/C4	207	1668A	213	1702PMR	218	1719BMA...B5	222

ÍNDICE ALFANUMÉRICO

1719BMA...M	222	1741U	226	1759HD/RR	231	1772M	238	1833M	243
1719BMA...P	222	1742AN	226	1759HD/TRUCK	232	1772R	239	1833MW	243
1719BMA...Q	221	1742AN/C	227	1759LR	232	1772R	607	1833RB-L/USB	242
1719BMA...R	222	1742AN/KR	227	1759TT	232	1772RL/2	239	1833S	243
1719BMA...S5	222	1742N	226	1760/IR1000	235	1773A	239	1833XL	243
1719BMA...T	221	1742N/C4	226	1760/IR1600	235	1773RL	239	1833XS/1	242
1719BMB/P	223	1742N/KR	226	1760/IR500	235	1773S	239	1833XS/2	242
1719BMC	223	1742R-A/M...	226	1760/OHM	233	1773S/RL	239	1833XSW	243
1719BMD...B5	222	1742R-AL/M...	226	1760/RMS	233	1774	239	1834RR	608
1719BMD...M	222	1749	227	1760/RSE	234	1774A	239	1836AW	243
1719BMD...P	222	1749A	227	1760/TC2	235	1774A/RL	239	1836B	243
1719BMD...Q	221	1749A/RB	227	1760B	233	1774S	239	1837C	244
1719BMD...R	222	1749A/RT	227	1760DGT	232	1776BA	312	1837F	243
1719BMD...S5	222	1749AC	227	1760DGT/2	233	1777BM	239	1837F/USB	244
1719BMD...T	221	1750	227	1760DGT-R3	234	1777BMT	239	1837M	244
1719BMR	223	1750CG	227	1760K	235	1777BMT	607	1837RB-F/USB	244
1719BMR/B3	223	1750KG10	228	1760LX	236	1777MQ/C	291	1837S	244
1719BMX...M	222	1750M	228	1760PA/80	234	1777MQ/U	291	1838/11LED	245
1719BMX...P	222	1750M3	228	1760PA/AC	234	1777RL/U	291	1838AM	245
1719BMX...Q	221	1750R/1 - 1750R/2	227	1760PA/AC-DC	234	1777T	239	1838COB	245
1719BMX...R	222	1750RC	227	1760PA/AC-DC2000	234	1777T	607	1838E	246
1719BMX...S5	222	1750RP/1 - 1750RP/2	227	1760PT	235	1778AN	239	1838E-BT	246
1719BMX...T	221	1750RT	227	1760R/TC2	235	1778AX	240	1838FLASH	244
1719R/...	223	1750TA	228	1760S	233	1778BS	240	1838P	245
1720/...	223	1750TLA	228	1760TMC	236	1778CM	240	1838POCKET	244
1720/B	223	1751CR	228	1760WMM	236	1778M7	240	1838RA/10-11LED	245
1720/S	223	1751N	228	1761	236	1778MT	241	1838RB/10LED	245
1720D/...	223	1752	228	1761RS/1	236	1778P	240	1838RB/FLASH	244
1720D/B	224	1754	228	1762	236	1778SCL	240	1838RR/11LED	245
1721/B6	224	1755C	229	1762K	607	1778SOS	240	1838RV/11LED	245
1723	224	1756	229	1763	236	1778V18	240	1838SLIM	245
1725	224	1756B	229	1763G/S500	236	1778X	240	1838SW	246
1725CR	224	1756C	229	1764/K5	236	1781	241	1838UV	246
1725MQ	291	1756C-2OR	229	1764/K5-R	236	1783	241	1839/R1	246
1726	224	1756D	229	1765/C24	237	1783	607	1839/R2	246
1726BM	224	1756D-2OR	229	1766	237	1784	241	1839/R4	246
1727	224	1756E	229	1766/8	237	1784BA	312	1839/R5	246
1727BA	312	1756G	229	1766A	237	1800/100	241	1839/R6	246
1727BM	224	1757	229	1766ER	237	1808	251	1839BRW	246
1728...	224	1757A	229	1766ER/VW	237	1812 150	251	1842	248
1728BA	312	1758	229	1766G	237	1814M	251	1842LED/ABM	247
1729CG	224	1758A	230	1766I	237	1820	251	1842LED/BM	247
1729DM 450	224	1758ADB-45°	230	1766L	237	1820 60	251	1843	248
1730	224	1758ADB-D	229	1766LI	237	1820 80	251	1844	248
1730M	224	1758B	230	1766T	237	1822	251	1844SCK	248
1730V 38	224	1758B/K5	230	1767A	238	1822 180	251	1845	248
1736A	224	1758B-1,6	230	1767B	238	1822 320	251	1846	248
1737	225	1758BA	312	1767PMC	238	1823 60	251	1846R-LED/BM	248
1737AC	225	1758B-RNT	230	1767PMR	238	1823R/60	251	1847	249
1737B	225	1758LG	230	1768	238	1824R	251	1848	249
1737BA	312	1758M	230	1770	238	1825B	251	1850D	325
1737NX	225	1758R	231	1770A	238	1827	251	1850E	325
1738	225	1758RD	230	1770BM	238	1827/K	252	1851VK	325
1739C	225	1758S	230	1770BM	607	1827F	252	1851VK-12C	325
1740AN	225	1758VT	231	1770RL	238	1827PC	251	1851VK-12V	325
1740B	225	1758VT/L	231	1771	238	1827PCL	251	1852 S-PIATTE	249
1741B	225	1759	231	1771BM	238	1827PFL	252	1852R1750	249
1741B/C5	225	1759A	231	1771HD	238	1830T	252	1852S-CC	249
1741BP	226	1759B	231	1771RL	238	1833L	243	1852S-CNT	249
1741RV...K	226	1759HD/3	231	1772H	239	1833L/USB	242	1852S-F	249

ÍNDICE ALFANUMÉRICO

1852S-FLESS	249	1885/C1-R3	258	1916G	348	1930CD	334	1945C/G...	342
1852S-KR/CNT	249	1885/C1-R4	258	1916GF	348	1930HLA	335	1945C/GP...	342
1852S-L	249	1885/C1-R5	258	1916GFE	348	1930LA	335	1945P	342
1860BH R/CM	252	1885/C1-R6	258	1916I	348	1930LH	334	1945P/S...	342
1860BH R/CS	252	1885/C1-R7	258	1916JF	348	1930PA	334	1945S	342
1860BH/120A	252	1885/C1-R8	258	1916JM	348	1930ZL	335	1945S/G...	342
1860BH/160A	252	1885/C2	258	1916P	348	1931AN10	336	1946	343
1860BH/200A	252	1885/C2-R1	258	1916S	348	1931CD10	335	1946C/T...	343
1860BHT R/CM	253	1885/C2-R2	258	1917F	348	1931CD13	336	1946C4,8	343
1860BHT R/CS	253	1885/C2-R3	258	1917JF	348	1931CD6	335	1946C7,8	343
1860BHT/160A	253	1885/C2-R4	258	1917JM	348	1932B10	336	1946KF	343
1860BHT/T	253	1885/C2-R5	258	1917M	348	1932B13	336	1946KF/M...	343
1860DM	253	1885/C2-R6	258	1917RG	348	1932RS13	336	1947	343
1860EI	253	1885/C2-R7	259	1917SP	349	1933	337	1947G	344
1860M	253	1885/C3	259	1917ST	349	1933AN90	337	1947G2	344
1860PMIG	253	1885/C3-R1	259	1918	349	1933AN90-H	337	1947H	343
1860RG	253	1885/C3-R10	259	1918N	349	1933I	337	1948	344
1860SQ	253	1885/C3-R2	259	1918R	349	1933IH	336	1948PR	344
1870	325	1885/C3-R3	259	1919F1/2	350	1933IL	337	1949BC	345
1870-20/5S	326	1885/C3-R4	259	1919F1/4	349	1933ILH	337	1949BC/RUL	345
1870-72 /FC	326	1885/C3-R5	259	1919F3/8	350	1933L	337	1949DGT/2	346
1870-72/FL	326	1885/C3-R6	259	1919FE1/4	349	1934BV	337	1949F2	345
1870I	325	1885/C3-R7	259	1919L	350	1934MAV	338	1949GPA	345
1872L	326	1885/C3-R8	259	1919ML	350	1934MAV70	338	1949GPN	346
1872L 35/5S	326	1885/C3-R9	259	1919RB-F	350	1935F	338	1949M	346
1872L 35/FC	326	1885/XC60	259	1919RB-FE1/4	349	1936/4A	338	1949P	345
1873	326	1889CF	257	1919RF-F	350	1936/5A	338	1949R	346
1873-30/5S	326	1889N	257	1919RF-FE1/4	349	1936/7A	338	1949T	345
1874	326	1893/1234YF	260	1919RM-F	350	1937	339	1949U5	344
1874-50/5S	326	1893/134A	259	1919RM-FE1/4	349	1937C...	339	1949U5/A	344
1874-50/FC	326	1893TR/1234YF	260	1919SC	350	1937K...	339	1949U5/B	344
1875LT	255	1893TR/134A	260	1921B1	330	1937KC	339	1949U5/C	344
1875SP/K3	255	1893TR/CI	260	1921M1	330	1937KL	339	1949U5/D	344
1877	255	1895 13	260	1921M2	330	1937KL-D	339	1949U5/E	345
1877A	255	1895 27	261	1921N3	330	1937M	339	1949U5/F	345
1877F	255	1895 6	260	1922P1	330	1937M-01÷11	339	1949U5/G	345
1877P	255	1895/RC	261	1922P2	330	1937N10	340	1949XS	344
1878 11	256	1895/S	260	1922P3	330	1937N10-GR	340	1950BZK	346
1878 2	255	1895G	260	1924B	331	1937N20	340	1951	346
1878 3	255	1897	261	1924CD	331	1937N20-GR	340	1951A	346
1878 30	256	1897/CRB	261	1924F	330	1937R/P	339	1952	347
1878 4	255	1897/G	261	1924XM	331	1938	340	1956 115-750W	322
1878 8	256	1897/MV	261	1927AN	333	1938R/L	340	1956 125-1400W	323
1879	256	1898/B	261	1927B	331	1938R/S5	340	1956 230-2400W	323
1879 6	256	1898/D	262	1927B/K5	331	1940	340	1966/910W	324
1879/FUEL	256	1898/K40	261	1927CD	332	1940/C6	340	1967/800W	324
1879R/K4	256	1898/M	262	1927CD/K3	332	1940/S5	341	1972/12V-10	315
1880	256	1898/S	262	1927G	333	1940E10	341	1972/20V-13BMC	316
1880ADB	256	1899A	262	1927P	332	1940E10/MT	341	1972/K12V-10	314
1881	256	1899SI	262	1927P/K3	332	1940E10/S...	341	1972/K12V-COMBO	314
1882N	256	1900M 8X15 - 1900M 10X15	347	1927SP-AM	333	1940E10/S5	341	1972/K20V-13BMC	316
1883N	256			1927XM	332	1940MT	341	1982/12V	315
1883NC	257	1900S 8x10	347	1927XM/K5	332	1940S...	341	1982/K12V	314
1884	257	1914	347	1928CD	334	1942A	341	1984 20V/1200BMC	318
1884/C12	257	1915B	347	1928DA	333	1942LR	341	1984 20V/600BMC	317
1884N/C8	257	1915C	347	1928DAL	333	1944A	341	1984/K1200	318
1885	257	1915C/L	347	1928K4	333	1944AR 2	341	1984/K600	317
1885/C1	258	1915D	347	1928P	334	1944N	341	1986/20V-125BMC	319
1885/C1-R1	258	1915E	347	1928XM	333	1944PA	342	1986/K20V-125	319
1885/C1-R2	258	1915E/XL	348	1930A	335	1945C	342	1989RCB	321

ÍNDICE ALFANUMÉRICO

1994B 20V-2AH	320	11204B	577	11491	584	2254T	263	330R/A	28
1994B 20V-4AH	320	11208A	577	11493	584	2258N-O	263	330R/I	28
1994B 20V-6AH	320	11208B	577	11495	584	2258RR	263	331C	28
1994BL 12V-2AH	315	11210A	577	11498	584	2300ST/KIT	370	332	29
1994C 20V	320	11210B	577			2400 RSC24/MP	378	334	29
1994CB 12V	315	11212A	577			2400 RSC24/PC	377	334R	29
1995MQ/G1 - G2	291	11212B	577			2400 RSC24/PD	377	334R/I	29
1995MQ/T	291	11214A	578	2001/B26	352	2400 RSC24/PF	377	336	29
1996MQ/GM	291	11214B	578	2001/BV	352	2400 RSC24/PF-	377	338	29
1996MQ/T	291	11214C	578	2001/BZ24 MQ	353	2400 RSC24/PL	377	338R	29
1996SVG	291	11216A	578	2001/BZ27 VU	353	2400 RSC24/SPC	378	338R/I	29
11001	570	11216B	578	2001/BZV	352	2400 RSC24AXLP/PCPR	376	338RP	29
11001H	570	11218A	578	2002/BV12	353	2400 RSC24AXLP/PF	376	339A	29
11003	570	11218B	578	2002/BV13	354	2400 RSC24AXLP/VL	377	339A/R	29
11011	570	11220A	578	2002/BV42	354	2400-COVER RSC24	393	340	29
11011H	570	11220B	578	2002/BV6	9	2400-COVER	393	340C	30
11018	570	11222	579	2002/BV7-ZIP	353	RSC24AXL		340C/KRL	30
11019	571	11230A	579	2002/BV8	353	2499PC	378	340RL	29
11021	571	11230B	579	2002/BV9	353	2499PF	378	341	30
11023	571	11232A	579	2002/BVL6	353	2499PF/M	378	341B	30
11024	571	11234A	579	2005MPU	354			341B/RL	30
11031÷11038	571	11240A	580	2005MPU/E	354			341B/RM	30
11032	571	11240B	580	2005PA/D	354	30	9	341RL	30
11034	571	11242A	580	2005PA/E	354	30BA	304	342	30
11035	571	11242B	580	2005PA/ET	354	31	9	342A	30
11037	571	11246A	580	2005PA/S	354	31/B6N	9	342A/MOL	30
11038	571	11248A	580	2005PA/U	355	31/B6N-LSE	9	342A/RL	30
11040	572	11248B	580	2009N/BV	354	31_serie	9	342MOL	30
11045	572	11259	580	2028/VV	355	31BA	304	342P	30
11046	572	11260	581	2028E	355	31BA/C	304	342P/RL	30
11048	572	11263	581	2029/VV	355	31BM	9	342RL	30
11049	572	11264	581	2029E	355	31BM/D6	9	345	31
11050	572	11265	581	2029EM	355	31L	9	345C	31
11069	572	11266	581	2032/TE	356	31SE	9	345SB	31
11100	573	11268	581	2032/TV	355	32	9	345SB/R	31
11101	573	11271A	581	2033L	356	32AU	9	345SB2	31
11102	573	11271B	581	2033L/VV	356	32AUR	10	345SC	31
11105	573	11271C	581	2036/TV	356	32BA	304	345SI	31
11106	573	11276A	581	2036E	356	33LT	10	345SI/R	31
11107	574	11276B	581	2037/TV	356	33NR	10	345U	31
11110	574	11276C	581	2038/TV	356	34	10	345U/A	31
11111	574	11300A	582	2041UC	357	34BA	304	349	31
11115	574	11300B	582	2051N	357	35	10	349/SMAS	31
11116	574	11300C	582	2055HB	357	35PM	10	349/SMM	31
11120	574	11300D	582	2080/D10	357	35PMR	10	350	32
11121	575	11300E	582	2080/V12	357	36	10	351C	32
11125	575	11300F	582	2080/V12-...	357	37	10	351P	32
11130	575	11300G	582	2080/V6	357	37PM	10	352C/U	32
11131	575	11320	582	2080/V6-U	357	37PMR	10	352U	32
11132	575	11411	582	2080/VG	262	38/DS1	611	355	32
11135	575	11415B	582	2109MT ID/1	360	38/DS2	611	357F3	32
11140	576	11420B	583	2115P L-MQ32	362	38_serie	10	357R/F3	32
11141	576	11431	583	2115PI/BIKE-HOME	361	39BA	305	358	32
11145	576	11440A	583	2250-O	262	310	27	358RL	32
11200A	576	11440B	583	2252	262	310/C8	28	359	32
11200B	576	11440C	583	2252KR4	262	310B	27	359CH	33
11202A	576	11450A	583	2254A	263	311	28	360	33
11202B	576	11450B	583	2254C	263	330	28	360R/...	33
11202C	576	11450C	583	2254F	263	330BA	307	361N	33
11204A	577	11488PF	584	2254K	263	330BA/2R	307	362	33
				2254SM	263				

362R/...	33	3010/T...	266	3040C/S2	274	3500/P-M	385	4		
363	33	3010H	266	3041C	274	3700/PC	388			
363BA	307	3010V	266	3041C/12	274	3700/PF	388		42	11
363R/...	33	3011/T	266	3041C/16	275	3700/PFL	388		42/B	10
365	33	3012	267	3042C	275	3700/PLA	388		42/B9N	11
365R/...	33	3012C	267	3043C	275	3700/PLL	388		42/S	12
366	33	3012I	267	3043C/ 41÷47	275	3700-COVER C37	393		42/SC9I-E	12
374	33	3014	267	3047C	275	3910	281		42/SP_plastica	12
374K	597	3014 SAR	267	3048C	275	3912PP	281		42/SP25	12
374R/...	34	3014R/GR5	267	3050/600	275	3912TP	281		42AS	12
375	33	3014SAR/1	267	3050/CC	275	3912TP/A	281	42AS/B9N	12	
376	33	3014SAR/2	267	3050/KA	275	3912TP/C	281	42AS/S	12	
378	34	3014SAR/RR	267	3050/LA	276	3912TP/FOX	281	42BA	305	
378BA	307	3023	267	3050/MS	275	3912TP/QRE	281	42BA-AS	305	
383	34	3025N	267	3050/MV	276	3912TP/ROAD	281	42LMP	13	
383R	34	3025N/PF	268	3054	276	3912TP/RS	281	42LMP/S	13	
384	34	3026 0,3	268	3055M	276	3912TP/ST	281	42MP	12	
384RC	34	3026 0,5	268	3057	276	3916MMP	282	42MP/B9N	12	
386A	34	3026 1,0	268	3061/2T	272	3918MML	282	42MP/S	12	
386A/RC	34	3026/R 1,0	268	3061/2T-P100	272	3921	282	42NEWK	596	
386BA	307	3026/R0,3	268	3061/2T-P50	272	3923	282	42SLIM	13	
387	34	3026/R0,5	268	3065/20-10T	273	3927	282	42SLIM/B8NI-E	13	
387R	34	3026/S	268	3065/40-20T	273	3932U	282	42SLIM/S11	13	
388	34	3026/SA	268	3067/60-15T	273	3935	282	45	13	
388A	34	3026/SAM	268	3067/70-13T	273	3937	282	410	36	
388C/C8	35	3026/SP	268	3068	273	3948	282	410/SEL	37	
389/K4	35	3027/PR	270	3069	273	3952	282	410/SP	36	
392C	35	3027N 10	269	3070B	276	3952/S	282	410A	37	
392RG/C	35	3027N 100	269	3070B/10	276	3953	282	410AS	37	
393	35	3027N 20	269	3070BE/B	277	3955	282	410AS/SEL	37	
395	35	3027N 30	269	3070BE/F	277	3961 3,2	282	410AS/SP	37	
395T	35	3027N 50	269	3070BE/K	276	3961 3,3	283	410MIX/SEL19	37	
398	35	3027N/KP	269	3070BE/S	276	3961 3,5	283	412	37	
399	35	3027N/KPP	269	3071A	277	3961U	283	412/C150	38	
399R/...	35	3028 15	270	3071B	277	3962MV	283	412/SP	37	
3000L	263	3028 20	270	3071RS	277	3962SH	283	412/SP91	38	
3000L/RLS	263	3028 30	270	3072N	277	3963P	283	412A	38	
3000M/PLM	383	3028 50	270	3073	277	3964	283	412L	38	
3002	264	3028/KP	270	30740	277	3965	283	412XL	38	
3002/RLS	264	3028SP/15	270	30740/2	278	3965C	283	414	38	
3003	264	3028SP/20	270	30740/M	278	3967	283	414/C116	39	
3003/RLS	264	3028SP/30	270	30740/S	278	3969	283	414/SP	38	
3003C	264	3028SP/50	270	3075/CM	278	3969K3	283	415	39	
3003C/RLS	264	3029/2T	271	3075/K10	278	3971	283	415/C116	39	
3003PRO	264	3029/2T-L/R5	271	3075A	278	3972	283	415/SP	39	
3003PRO/PM	264	3029/2T-L/R6	271	3075B 55	278	3973/1	283	415/SP91	39	
3003PRO/RRCR	264	3029/2T-L/RP	271	3075MV	278	3973/2	284	415CO	39	
3003PRO/RRG	265	3029L/2T	271	3079/21	278	3973/3	284	415CO/SP	39	
3003PRO/RT	265	3030/2T	271	3080/C15	278	3973/4	284	415CO-A	39	
3003PRO/SP	264	3030/2T-R5	271	3080R/CS3	278	3973PF	283	415L	40	
3004	265	3030/2T-R6	271	3081	278	3975	284	416	40	
3006	265	3030/2TRP	271	3085	278	3984/1	284	416/SP19	40	
3006 R/RG	265	3030H/2T	271	3091	279	3984/2	284	416P/SP19	40	
3006 R/RGF	265	3033/3T	271	3092	279	3984/3	284	417	40	
3007	265	3033E/3T	272	3093/E	279	3984/4	284	417/SP	40	
3007 R/RG	266	3033S 3T/R2	272	3093/U	279	3984/5	284	419	40	
3007 R/RGF	266	3035	272	3094PA	279	3984/6	284	419/SP	40	
3008N	266	3036	272	3095	279	3991	284	419T	41	
3009	266	3040C	274	3099E	279	3992	284	421	41	
3009R/GR4	266	3040C/S1	274	3099T	279					

ÍNDICE ALFANUMÉRICO

421/SP6	41	437K/12	47	53	13	5904VI/2T	482	605E	62	
422	41	437K/16	47	55	13	5904VI/3T	483	606_RIC	63	
423	41	437K/33	47	55/B12N	14	5904VU/1M	490	606MQ/50	287	
423A	41	437K/8	46	55/B8N	14	5904VU/2M	491	610/5	62	
424	41	437K/9	46	55/S	14	5904VU/2T	492	610L/5	62	
424/SP	41	437P	46	55/SP	14	5904VU/3T	493	610L/5L	62	
425	41	437U/09	47	55AS	14	5904VU/4T	494	611	62	
425/SP	41	437U/E-M...	47	55AS/S	14	5905VG/1	525	612 ÷ 614	62	
426	42	437U/PM	47	55BA	305	5905VG/2	526	614/50	63	
426/SP	42	438...	47	55BA-AS	305	5908VG/2T	527	615	63	
426A/SP6	42	438A	47	55K	596	5908VI/2T	484	616 - 617 - 619	63	
426MD/CP	43	440	47	55MP	14	5908VU/2T	495	621	63	
426MD/CT	43	440A	47	55MP/S	14	5910VI/3	485	622	63	
426MD/F	43	440ASC	48	58	14	5910VI/3T	486	641	63	
426MD/FA	43	440ASF	48	58BA	305	5914VU/M	496	642	63	
426MD/OG	43	440ASG	48	58BA-AS	305	5915VU/0	498	643	63	
426MD/OV	43	440ASW	48	560/C12	55	5915VU/1	498	644	63	
426MD/S	43	440B	48	560/C2	55	5915VU/2	499	650A	64	
426MD/SP10	43	441	48	560/C3	55	5915VU/3	499	650H	64	
426MD/T	43	441A	48	560/C3PLUS	55	5915VU/4	500	652	64	
426MD/TA	43	441B	48	560/C4+	55	5915VU/5	500	653	64	
426MD-3/A9	43	442	49	560/C6	55	5915VU/AS	501	654	64	
426MD-3/CP3	42	443	49	561/1	55	5927VU/M	501	659/15	64	
426MD-3/CT3	42	444	49	562-1/VA - 562-2/VA	56	5935ET/1MB	511	659/16	64	
426MD-3/F3	42	444G	49	562VV-A	56	5935VG/1MB	528	665	64	
426MD-3/FA3	42	446/C110	50	564-3R/V - 564-4R/V	56	5935VI/2MB	487	665LB	65	
426MD-3/OG3	42	446/C30	49	565-1R/VA - 565-2R/ VA - 565-3R/VA	56	5938U/2T	502	665SW	65	
426MD-3/OV3	43	446/C48	49	565-4R/VB	56	5940SBK	528	666	66	
426MD-3/S3	43	446ASC/C37	50	565-5R/VB	56	5941VU/M	529	666 LBF.FT	66	
426MD-3/T3	43	446ASF/C29	50	565VV-B	56	5945VUM_2024	530	667	66	
426MD-3/TA3	43	446ASG/C23	50	567-4R/VB	56	5954VG	531	668N	66	
426SB	42	446ASW/C36	50	567-5R/VB	56	5954VI	489	668RG	67	
426SB/SP	42	447/C37	51	581	60	5957U-P	503	668RGC	67	
426T	42	447/C53	51	583	60	5957VG	532	669N	67	
426T/SP	42	447/C70	51	583/C31	60	5957VI	488	671B/C10	67	
427	44	450	51	590 - 592	60	5958U	504	671B/C5	67	
428/C14	44	450/C13	52	594	60	5980/MQ	513	671N/C10	67	
428FC	44	450/C15	52	596 - 598	60	5980EL/A	514	671N/C20	68	
428FP	44	450/C21	52	599DGT	61	5980EL/B	515	671N/C30	68	
429/C14	44	450/C9	52	599DGT-AN	61	5980ET/A	512	674/C	68	
429FC	44	450AD	51	5000 RSC50/ASL	475	5980ET/B	513	677	68	
429FP	44	450AL	51	5000 RSC50/CAL	453	5980ID/1	516	677/C	68	
430	44	450PA/1	52	5000 RSC50/CLL	453	5980U/BIKE	506	677/CP2000	68	
430/SP	44	450PA/2	52	5000 RSC50/CTR	476	5980U/BIKE-M	507	677/CV - 678/CV	69	
430ASC	45	450PR	52	5000 RSC50/KFC	453	5988 VHB-MQ	514	678/C	69	
430ASW	45	451	52	5000 RSC50/MP	453	5988H/7M	508	680	69	
431	45	451/C	53	5000 RSC50/MPA140	453	5988L/4M	509	682	69	
431/SP	45	451GA	53	5000 RSC50/PLED	475	5988U/7M	497	6200AP/S10	670	
433	45	451PA	53	5000 RSC50/PLED-ST	475	5988U6/M	510	6600 M/112	618	
433ASF	45	451PR	53	5700LAMP	405	5989 VEM	517	6600 M/116	618	
433ASG	45	452	53	5902MT	518	5990V1	505	6600 M/120	618	
434	45	452GA	53	5902MT/AS	519	5990V3	505	6600 M/125	618	
435	46	460	53	5902VI	481	6			6600 M/126	618
435G	46	460G	53	5904VG/2M	520				6600 M/131	618
436	46	460PP	53	5904VG/2T	521	600	61	6600 M/14	616	
436L	46	4900-COVER C49	397	5904VG/3	522	601C	61	6600 M/174	618	
436R	46	5			5904VG/3T	523	601CA	61	6600 M/175	618
437C	46				5904VG/5T	524	603	62	6600 M/217	618
437C/...	46	52	13	5904VI/1T	481	604B	62	6600 M/218	618	
437C/RM14	46	52MQ	286			605DGT/2	62	6600 M/22	616	

ÍNDICE ALFANUMÉRICO

6600 M/222	618	6600 M/881	622	720RNG	72	7042LCD/RV	254	7352B	642
6600 M/223	618	6800 VE	616	720S	71	7042LCD/RV-INT	254	7352G	642
6600 M/230	619	6800BA	670	720S/SB6	71	7043	254	7352LG	643
6600 M/236	619	6800RS	670	720TC	72	7061TC	669	7353Y	643
6600 M/241	619	6888	616	720TC/S5	73	7076BC	669	7354N	643
6600 M/242	619	6888B1/2	609	720TX	73	7076BD	669	7355V	643
6600 M/253	619	6888B1/4	609	720TX/C6	73	7076BP	669	7356G	644
6600 M/27	616	6888B3/8	609	720XZN	73	7076BU	669	7356LN	644
6600 M/29	616	6888GS	670	720XZN/C6	73	7093BC	669	7356V	644
6600 M/311	619	6888GW	670	727/C16	75	7093BD	669	7357G	644
6600 M/315	619	7		727/ES16	74	7104 90	668	7357V	645
6600 M/320	619	7		727/ES16TX	74	7105 6	668	7362B	645
6600 M/326	619	73	15	727/ES16XZN	74	7109A	668	7363N	645
6600 M/327	619	73/B13N	15	727/ES22	75	7109D	668	7371V	645
6600 M/33	616	73/S	15	727/ES22TX	75	7201BKK	637	7372B	646
6600 M/330	619	78	15	727/ES32	75	7210BKK	637	7376A	646
6600 M/371	619	78AS	15	727PI/16	74	7212B	634	7381N	646
6600 M/380	620	78BA	305	727PI/16 1/2	74	7212G	635	7382N	646
6600 M/40	617	78BA-AS	306	727PI/22	75	7213G	635	7398 0/G	648
6600 M/406	620	710	70	727PI/32	75	7214FN	635	7398EF	649
6600 M/417	620	710/16	70	728	75	7214G	636	7398ESD	648
6600 M/42	617	710/20	70	728/15	76	7215FN	636	7398GEL	648
6600 M/423	620	710/21	70	728/16	76	7216BKK	637	7398T	648
6600 M/424	620	710/22	70	728/21	76	7218FN	636	7398U	648
6600 M/427	620	710/25	70	728/22	76	7218G	636	7398UP	648
6600 M/430	620	710/C10	70	728/22L	76	7220PEK	633	7399 A/N...	649
6600 M/44	617	710/OR... - 710/SP...	70	728/25	77	7221PEK	633	7421	649
6600 M/440	620	720	70	728/C10	75	7222PEK	633	7422P	649
6600 M/456	620	720/15	73	728/OR - 728/SP	77	7223PEK	634	7425	649
6600 M/465	620	720/16	73	728AS	76	7236BK	638	7426P	649
6600 M/47	617	720/20	74	728B	75	7238WR	638	7427	649
6600 M/480	620	720/21	74	728B/C10	75	7241BK	630	7430T	649
6600 M/485	620	720/22	74	728FTX	76	7241CK	630	7431P	649
6600 M/51	617	720/25	74	728L	76	7241EN	629	7527	652
6600 M/510	621	720/C12	70	728L/S	76	7243BK	630	7528	652
6600 M/52	617	720/C24	71	728LQ	76	7243CK	631	7529	657
6600 M/532	621	720/C6	70	728LS	76	7243CR	631	7530	652
6600 M/534	621	720/OR... - 720/SP...	74	728ME	76	7243EN	629	7545F	664
6600 M/542	621	720/SN	73	728ME/C6	76	7243FT	631	7547AZ	664
6600 M/548	621	720AS	71	729	77	7245BK	631	7547BL	665
6600 M/561	621	720B	71	729/15	64	7246BK	632	7547G	665
6600 M/58	617	720B/C12	71	729/16	77	7246E	629	7547N	665
6600 M/583	621	720FRD	72	729/21	77	7247BK	632	7547R	665
6600 M/59	617	720FTX	73	729/21L	77	7249GK	638	7548C	665
6600 M/61	617	720FTX/SB	73	729/22	77	7293HM	647	7548M	665
6600 M/62	617	720IC	72	729/25	77	7294HM	647	7549AZ	665
6600 M/63	617	720L	71	729/OR... - 729/SP...	77	7294HMC	647	7549BL	665
6600 M/643	621	720L/S3	71	729L	77	7314AF	639	7549G	665
6600 M/650	621	720LC	72	729LS	77	7315AN	639	7549N	666
6600 M/657	621	720LC/C3	72	729T	77	7316NB	639	7549NE	666
6600 M/658	621	720LC/PM5	72	730	78	7316NG	640	7549R	666
6600 M/716	622	720LC/S5	72	730/15	78	7317NA	640	7550G	666
6600 M/73	617	720LCL	72	730/21	78	7318AN	640	7550N	666
6600 M/813	622	720LCL/C3	72	730/25	78	7320NA	640	7557BL	666
6600 M/842	622	720LS	72	730L	78	7321NA	641	7575N	661
6600 M/852	622	720MC	71	733/15	78	7322SA	641	7579QN	661
6600 M/856	622	720MC/C13	71	7041LCD/4S	254	7323SA	641	7600G	652
6600 M/857	622	720ME	73	7041LCD/4S-VE	254	7328A	632	7600N	652
6600 M/871	622	720ME/C8	73	7041LCD/4S-VI	254	7328N	632	7610G	653
6600 M/878	622	720MRC	72	7042LCD	254	7352A	642	7610N	653

ÍNDICE ALFANUMÉRICO

7611G	657	7907G	662	861PE	81	8002ZS	676	8040EN-K	684
7636N	663	7909B	660	861PH	80	8003ZD	676	8040EZ	684
7637G	663	7909G	660	861PH/C	80	8003ZS	676	8040EZ	684
7642G	663	7909P	660	861PZ	80	8004ND	676	8040EZ-K	684
7650	653	7909V	660	861PZ/C	81	8004NS	676	8041	683
7650B	653	7930MG	656	861RIBE	81	8005TZ	673	8041-K	683
7653G	660	7931MG	658	861RTX	81	8005TZ-K	673	8042EN	685
7654B	663	7935MG	659	861SP	81	8005Z	673	8042EN-K	685
7654N	664	7937MG	662	861TQS	81	8005Z	673	8042EZ	685
7657B	664	7940	656	861TRW	81	8005Z-K	673	8042EZ	685
7657N	664	7949	661	861TX	81	8006Z	673	8042EZ-K	685
7658CM	662	7970	666	861TX/C	81	8006Z	673	8043	684
7659N	662	7971L	667	861XZN	81	8006Z-K	673	8043-K	684
7660B	653	7978L	667	862F	83	8007Z	674	8044	685
7660G	653	7979	667	862F/A7	83	8007Z-K	674	8048	677
7661B	657	7980L	668	862LP	82	8008N	674	8049	682
7661G	657	7980NC	668	862PE	82	8008N-K	674	8049A	683
7664G	664	7980RN	668	862PH	82	8008TZN	674	8049V	683
7664N	664	7981N	668	862PH/L	82	8009FD	677	8050 D	697
7665G	664	7982N	668	862PH-XL	82	8009FS	677	8051S	692
7665N	664	7984EG	668	862PZ	82	8009TZ	674	8051S-K	692
7669N	662	7984G	668	862TX	82	8009TZ-K	674	8052 - 8055S	691
7670G	662	7985N	668	862TX/L	82	8009Z	674	8057R - 8057	691
7673NG	661	7996N	667	862TX-XL	82	8009Z	674	8058R - 8058	690
7674NG	663			862XP/A16	83	8009Z-K	674	8058R/PS	698
7750N	663	8		866LP	83	8010TZ	675	8060R - 8060	690
7780QN	663	80	15	866PE	83	8010Z	675	8060R/PS	698
7800G	668	80/S	15	866PH	83	8010Z-K	675	8061R - 8061F	691
7815CM	657	83	15	866PZ	83	8011TZ	675	8062	692
7818BL	654	83/S	15	866RTX	83	8011Z	675	8063	691
7818CM	654	83AS	16	866TX	83	8015	678	8063SL	691
7818G	654	83AS/S	16	867/...	84	8016	678	8064S	691
7818LN	654	88	16	867/C20	84	8016	678	8065SC	692
7819G	654	88/S7	16	867/C38	84	8016FR	679	8068S	683
7830SN	654	89BA	306	867/C52	85	8016-K	678	8074	695
7830ST	655	89MQ	286	867PE	83	8016U2	679	8074	695
7831SN	657	850MQ	287	867PE/L	83	8016UGK	679	8074A	695
7831ST	657	851	78	867RIBE	84	8016U-K	679	8074G	695
7840BL	655	851SR	78	867RIBE/L	84	8018E	679	8080	695
7849BL	660	852	79	867RTX	84	8018T	679	8080FM	695
7850G	655	855P	79	867RTX/L	84	8020	680	8082	695
7860B	655	855P	598	867TX	84	8020A	680	8083	696
7860G	655	860/55	79	867TX/L	84	8021A	680	8085R	690
7861B	658	860/58	79	867XZN	84	8025	681	8086	690
7861G	658	860/58K	598	867XZN/L	84	8025	681	8090F	710
7863G	658	860/C27	79	882	85	8025-K	681	8090R - 8090	690
7865B	659	860/C38P	80	882AN	85	8026A	682	8091	686
7865G	659	860LP	79	882M	85	8026A-K	682	8091SL	686
7867B	661	860MIX/A10	80	882M1	85	8026R	680	8092	686
7867G	661	860MIX/A31	80	882MSR	85	8026R-K	680	8092SL	687
7869G	660	860PE	79	882P	85	8028	682	8094	687
7880SC	655	860PE/A10	80	892	85	8028-K	682	8094SL	687
7900B	656	860PH	79	895	85	8029R	680	8096	688
7900G	656	860PHZ/A10	79	897	85	8029R	681	8096SL	688
7900P	656	860PZ	79	897L	85	8029R-K	681	8097	688
7900V	656	860RTX	79	8001TZ	675	8031R	681	8097SL	689
7901G	658	860TX	79	8001TZ-K	675	8031R-K	681	8098	689
7903G	659	860TX/A10	80	8001Z	675	8032	681	8098SL	689
7903P	659	861/C61P	82	8001Z-K	675	8032-K	681	8100	690
7905G	659	861LP	80	8002ZD	676	8040EN	684	8105	672

ÍNDICE ALFANUMÉRICO

8105-K	672	8180	710	8274	703	8889P3	559	96C/AS	19
8109	672	8181	710	8274	703	8889P4	559	96C/AS	596
8109-K	672	8181 6/S4	710	8274A	703	8889PD	560	96C-AS/SC9	19
8110	672	8181S	710	8274G	703	8889PS	560	96L	20
8114	696	8182	711	8276	703	9		96L/SC12	20
8116	696	8182 8,5/S2	711	8276G	704				96L/SP8
8120	694	8182A	711	8278	704	90	16	96LBP	20
8120B	694	8182E	710	8279	706	90/B8N	16	96LBP/SC9	20
8120D	694	8182GD	711	8280	704	90/S	16	96LBP/SC9	597
8120DZC	694	8182H	711	8282S	705	90/SP	16	96LC	19
8121MZC	694	8182H/2	711	8284	705	90AS	16	96LC/SC12	20
8129	695	8182S	711	8285	705	90AS/S	16	96LC/SC8	20
8130	695	8182T	710	8286	705	90BA	306	96N	18
8134	692	8182TS	710	8287	705	90K	596	96N/B	19
8135	692	8183	711	8290	705	91	17	96N/G	19
8135/KLA1	698	8184	711	8293	706	91BA	306	96N/SC12	19
8135/KMO	698	8185	712	8297C	706	92	17	96N/SC9	19
8143	692	8186	712	8297F	706	92BA	306	96N/ST	19
8143/RKCI	698	8187	712	8302Z	677	93	17	96N/ST6K	596
8143/RKL	698	8188/K8	713	8302Z	677	93BA	306	96T	21
8143/RPC	698	8188C	712	8303Z	677	93C	17	96T/AS	21
8143/RPF	698	8188CG/25	712	8303Z	677	93K	596	96T/S11	21
8146	693	8188CU/25	713	8317DZ	696	94	17	96T/S6	21
8146/RK	698	8188F	713	8317SZ	696	94/S	17	96T/SP	21
8146/RKCI	699	8188F35	713	8381SL	696	94K	596	96T/SPV	561
8146/RKFC	698	8188VFG2	713	8381SP	696	95	17	96TAS/S	21
8146/RKL	698	8189	713	8381SX	706	95/S	17	96TBP	22
8146/RPC	698	8189A	713	8383C	697	95BA	306	96TBP/S6	22
8146C	693	8189PA	713	8383P	697	95FTX	17	96TK	597
8147C	693	8190	712	8515CH	697	95FTX/S	17	97BRTL/SC8	23
8147P	693	8190B	712	8515V	697	96	18	97BTX	22
8147S	693	8201T	701	8515Z	697	96/B	18	97BTX/B	22
8148	694	8205	700	8531	697	96/BG7	18	97BTX/SC8	22
8148/RA	699	8205	700	8532	697	96/BGS7	18	97BTX-C	22
8148/RKCL	699	8206	700	8535	697	96/SC12	18	97BTX-C/SC8	22
8148/RKCM	699	8207	700	8600 R/11	622	96/SC9	18	97BTL	23
8148/RKG	699	8209	700	8600 R/113	623	96/ST	18	97BTL/SC8	23
8148/RKS	699	8210	700	8600 R/114	623	96/ST6K	596	97RTX	23
8148/RP	699	8210F	701	8600 R/12	622	96AS	19	97RTX/B	23
8148F	694	8210FTP	701	8600 R/13	623	96AS/B	19	97RTX/SC8	23
8149	699	8216	701	8600 R/225	623	96AS/BG7	19	97TTX	23
8149CM	699	8216	701	8600 R/412	623	96AS/SC9	19	97TTX/S	23
8149CM/RA	699	8216-K	701	8600 R/511	623	96AS/T	19	97TTX/SP	23
8150	706	8220	702	8600 R/601	623	96BA	306	97TX	22
8153	707	8225	702	8600 R/611	623	96BA/BP	306	97TX/B	22
8156	707	8225	702	8702N	677	96BAF-AS	307	97TX/BG8	22
8157	707	8227	702	8702Z	677	96BP	20	97TX/G	22
8158	707	8228	702	8702ZC	677	96BP/AS	21	97TX/SC8	22
8159	707	8240	702	8709N	678	96BP/ASB	21	97TX/ST	22
8160	707	8240F	702	8709Z	678	96BP/AS-SC9	21	98XZN	23
8161	708	8242	703	8709ZC	678	96BP/SC9	20	98XZN/B	23
8166	710	8242F	703	8889C1	559	96BPA	21	99	23
8170	708	8248	701	8889C2	559	96BPA/SC9	21	99 VN/...	24
8173	708	8249	701	8889C3	559	96BPA/SC9	596	99BA	307
8176	708	8249G	701	8889C6	560	96BPC	20	99SQ	24
8177	708	8250	704	8889CD	560	96BPC/SC9	20	99ST	24
8178	708	8264	704	8889CS	560	96BPC/SC9	596	900	86
8179A	709	8267	704	8889I4	559	96BP-CL	20	900/...	89
8179B	709	8272	705	8889P1	559	96BP-CL/SC9	20	900/16	88
8179M	709	8273	705	8889P2	559	96BP-CL/SC9	596	900/20LK	598

ÍNDICE ALFANUMÉRICO

900/25	89	900PE/AS	88	910BL/SB	94	920/55	104	920ES/SB	103
900/25K	599	900PH	88	910BP	96	920/55K	599	920ES/XL-SB	103
900/32	89	900PH/SB4	88	910BP/SB6L	96	920/55LC	105	920FTX	101
900/35A	89	900PT	88	910CF	96	920/55Q	104	920FTX/C	101
900/40	89	900PZ	88	910CF/SB	96	920/55X	105	920FTX/L	101
900/42	89	900T/44	89	910FTX	95	920/56A	105	920FTX/LSB	101
900/55	89	900TX	88	910FTX/L	95	920/58	105	920FTX/SB	101
900/55K	599	900TX/SB	88	910FTX/LSB	95	920/58K	599	920LH/SB7	101
900/55Z	90	900U	87	910FTX/SB	95	920/C37	107	920LP	101
900/55ZK	599	900U/C12M	92	910FTX/XL	95	920/R50	111	920M/35	104
900/58	90	900U/SB	87	910FTX-XL/C10	95	920/R55	111	920M/35L	104
900/58K	599	902A/C22	93	910LP	95	920/R55LC	112	920M/55	105
900/C11	90	902R/C6	93	910M/35	97	920/R55Q	111	920M/56	105
900/C11HR	93	910/15	96	910M/35L_WARN	104	920/R55X	112	920M/R55	111
900/C11Z	91	910/16	97	910M/55	97	920A	99	920MC	100
900/C12MR	91	910/20 - 910/21 -	97	910M/56	98	920A/AS	100	920MC/C14	106
900/C12MZ	91	910/22		910M/R55	111	920A/C11	105	920ME	102
900/C13-5	91	910/21K	599	910ME	96	920A/C12	105	920ME/C	102
900/C13-8	91	910/25	97	910ME/SB	96	920A/C12X	105	920ME/SB	102
900/C24	92	910/25K	599	910MQ/21	287	920A/C17HR	108	920MQ/21	288
900/C39N	90	910/36A	97	910MQ/22	287	920A/C17M	107	920MQ/22	288
900/C39U	90	910/40	97	910MQ/55	287	920A/C17MR	107	920MQ/55A	288
900/R55	111	910/42	97	910MQ/B	287	920A/C20	106	920MQ/A	288
900/R55-Z	111	910/46	97	910MQ/C16	287	920A/C20Q	106	920MQ/C16	288
900/SB	86	910/55	97	910MQ/PE	287	920A/C20X	106	920MQ/PE	288
900AN	89	910/55K	599	910MQ/PT	287	920A/C21	106	920MQ/T	288
900AS	87	910/55Q	97	910MQ/T	287	920A/C21X	106	920PE	102
900AS/C10	93	910/58	98	910MQ/TX	287	920A/C33	107	920PE/AS	102
900AS/C17-MBM	93	910/58K	599	910MQ/XZN	287	920A/SB13	99	920PE/C	102
900AS/L	87	910/R55	111	910PE	96	920A/SB8	99	920PE/SB	102
900AS/MB	87	910/R55Q	111	910PE/AS	96	920A-AS/SB11	100	920PE-AS/SB6	102
900AS/MB-C17	93	910/R55X	111	910PE/SB	96	920AK	599	920PH	101
900AS/MBL	87	910A	93	910PH	95	920AL	100	920PH/SB4	101
900AS/SB11	87	910A/AS	94	910PH/SB4	95	920AL/SB11	100	920RTX	103
900BG/30	89	910A/C10	98	910PT	96	920AN	103	920RTX/SB	103
900BG/30C	89	910A/C16	98	910PT/SB	96	920AS	100	920TX	102
900BG/30K	599	910A/C16HR	99	910TX	96	920AS/C10	108	920TX/C	102
900FL	89	910A/C16Q	98	910TX/SB	96	920AS/C15	108	920TX/C17	108
900FTX	87	910A/C17	98	910XZN	96	920AS/C17X	108	920TX/L-SB4	102
900FTX/SB9	87	910A/C29	99	911BA	307	920AS/L	101	920TX/SB	102
900K	598	910A/SB	93	911BA/16	307	920AS/MBM-C21	108	920U	101
900L	86	910A-AS/SB13	94	911BA/20	307	920AS/SB11	100	920U/C17M	109
900L/SB	86	910AK	599	911BA/55	307	920ASL/SB11	101	920U/SB13	101
900LP	87	910AL	94	914MQ/A	288	920B	100	920U/SB4	101
900M/35	89	910AL/SB14	94	914MQ-A/S4	288	920B/C11	105	920XZN	103
900M/55	90	910AN	97	920/15	103	920B/C12	106	920XZN/LS	103
900M/R55	111	910AS	94	920/16	103	920B/C12X	106	920XZN/SB12	103
900MB	86	910AS/C13	99	920/20÷920/23	103	920B/C20	106	920XZN/SB7	103
900MB/C19	91	910AS/L	95	920/21K	599	920B/C20X	106	921BA	308
900MB/C28	92	910AS/MBM-C18	99	920/25	104	920B/C21	106	921BA/15	308
900MB/L	87	910AS/SB13	94	920/25K	599	920B/C21X	107	921BA/16	308
900MB/SB	86	910AS/SN	95	920/35A	104	920B/C30Q	107	921BA/21 - 921BA/22	308
900MC	86	910ASL/SB12	95	920/36A	104	920B/C33	107	921BA/25	308
900MC/C24	92	910B	94	920/38	104	920B/SB13	100	921BA/42	308
900MC/C32	92	910B/C10	98	920/40	104	920B/SB8	100	921BA/50	308
900MC/LP	87	910B/C16	98	920/42	104	920BL	100	921BA/R50	308
900MC/PH	88	910B/C16Q	98	920/44	104	920BL/SB11	100	921BA-AS	308
900MC/TX	88	910B/C29	99	920/46	104	920BP	102	926BA	308
900ME	88	910B/SB	94	920/50	104	920BP/SB	102	926BA/15	308
900ME/SB8	88	910B/SN	94	920/50F	104	920ES	103	926BA/22	308
		910BL	94						

ÍNDICE ALFANUMÉRICO

926BA/42	308	944BX/S	114	960RPI	122	993G	126	9548KB	721
926BA/50	309	949	114	960SL	119	993MQ	289	9548KB 20	721
926BA/R50	309	949/S6	114	960SN	119	993PL	126	9548KB 24	721
928.../C12	110	950	114	960T/A	120	994	126	9549ABW	723
928/15	109	950/S	114	960T/B	120	994MQ	289	9549BP	723
928/16	109	951	115	960T/C	120	994PL	126	9549BRW	724
928/20 - 928/21 - 928/22	109	951/S	115	960T/C11	120	994TF	126	9549C	724
		951/SP	115	960T/F	120	996	126	9549CR	723
928/25	109	951AS	115	960T/G	120	998	126	9549MPC	723
928/36A	110	951AS/S	115	960T/H	120	999	126	9549SBW	723
928/42	110	951BA	309	960UC	121	999/B6N	127	9557J 2.0	717
928/55	110	951GP	115	960VTC	122	999A	126	9557N	717
928/R55	112	951GP/S6	115	960YP	121	999B	126	9559	722
928/R55X	112	951K	600	961BA	309	999C	126	9559/30MT	722
928A	109	951MQ	288	961P6	122	999D	127	9561V	722
928AS	109	951TX	116	961P6/S	122	999E	127	9561V 2,5	722
928AS/C12	110	951TX/S	116	962	122	999G	127	9561VV	722
928B	109	952	116	962C	122	9500TL	715	9561VV 2,5	722
928B/C12	110	952/D7	116	962M	123	9501TL	715	9562P12	726
928ME	109	952/S	116	962P	123	9501TLD	715	9562P2	726
929	110	952AS	117	963	123	9502TL	716	9562T1	276
929/15	110	952FTX	117	963BA	309	9503TL	716	9562T2	409
929/21 - 929/22	110	952FTX/S	117	964	123	9504TL	716	9562T3	276
929/42	110	952L	117	964BA	309	9505TL	716	9562TB	670
929/55	110	953	117	964BA/L	309	9510W	716	9563G	723
929/55PR	111	953/S	117	965	123	9520P	718	9563U	723
929/C8	111	953TX	117	965/S	123	9521	718	9565K	723
929/R55	112	953TX/S	117	965BA	309	9521OB	719	9565S	670
930	112	955	118	966/C3	123	9522A	724	9565T	723
930/C	112	956C	118	966BA	309	9523A	724	9569MS	725
930/S	112	956E	118	966BA/V	309	9523T	721	9569MS-2	725
932	112	956F	118	969/C5	123	9524SC	721	9569P	725
932/S	112	956L	118	969B	123	9525CM	718	9569S	725
933	112	957	118	970B	123	9525TR	718	9572LB	716
933/S	112	959	119	970IVECO	123	9525WB	718	9574B	718
935	113	959R	119	971/C8	124	9526F	719	9574O	718
935/S	113	960	119	972/C10	124	9526P	724	9577R	722
935K	599	960/22EP	120	972/C4BMW	124	9526RMN	724	9579C	722
937	113	960/C6	120	973	124	9527 6T	724	9580S	717
937/S	113	960/D	120	978 - 979	124	9528B	721	9586K	724
937BA	309	960A	119	982	124	9534BO	716	9587 13x21	725
937K	599	960AD/TP2	175	983 PM/R-DA	124	9534WO	716	9587 9x14	725
940	113	960AVE	121	983PM	124	9537TL	716	9588/10PI	725
941	113	960BC/C5	119	984	124	9539CB	720	9588M	725
941/S	113	960EPC/L	121	985/B7	124	9541BIKE	718	9588S/10...	725
942BX	113	960E-PI/P	121	985F	125	9541F	718	9589A/36	726
942BX/DG	611	960ER	119	985M	125	9541PC	718	9589B/36	726
942BX/S	113	960F	119	986 48	125	9541S	718	9590B	722
943BX	114	960G	119	986 78	125	9542AL	721	9592B/C50	724
943BX/D	114	960H/C4	119	986PT	125	9542AT	720	9592B/P	724
943BX/DG	611	960KC-M8/M9/M10	121	987	125	9542C	720	9592M/50	724
943BX/S	114	960KPC	121	987AR	125	9542G	720	9592MB	724
943BXK	600	960L	119	987P	125	9542GW	720	9593A	717
943FL	114	960M	119	988/K4	125	9542M	720	9593M	717
943FL/S	114	960P	121	989	125	9542S	720	9593S	717
943MQ	288	960PI	121	989A	125	9543C	721	9593SB	717
943MQ/BG	611	960PI/C19	122	989B	125	9544C	717	9593W	717
943MQ/S	288	960PI/K36	122	990	126	9547	724	9594	724
944BX	114	960PI/S	122	991	126	9547T	721	9595C	725
944BX/D	114	960PMC	122	992	126	9547WSK	721	9595T	725
944BX/DG	611			993	126	9548G	722		

ÍNDICE ALFANUMÉRICO

9596	725	C39/7	391	C45PRO PM	472	C55P/2MDX-SX	427	CB/2	561
9597P	721	C39/8	392	C45PRO PML	473	C55P/MCD	427	CB52	400
9597TRIOWAY	719	C39MD	394	C45PRO RD/X	467	C55PB/3	413	CD23S	369
9598WHP-N	719	C39SM	394	C45PRO SL	470	C55PB-PRO/7	414	CP	477
9598W-N	719	C39T	392	C45PRO SS	470	C55PB-PRO/8	414	CP15 - 2115	361
9599CB-N2	719	C41H	395	C45PRO T3	469	C55PFA-0,8	429	CP15L - 2115	361
9599CB-WN	719	C41H/CE	395	C45PRO TC	469	C55PFA-1,0	427	CP17 - CP17L - 2117	362
9881U	261	C41S	395	C45PRO W	457	C55PM	427	CP51	400
9882R	261	C42H	396	C45PRO X	456	C55PM/M0,8	429	CPMB/3C	476
9899 CV/A	111	C45PRO A1/R600	473	C45PW/1-0,7MT	463	C55PRO B/2	415	CPMB/5C	477
9899 CV/B	111	C45PRO A1/RB600	474	C45PW/2-1,3MT	464	C55PRO B/2,8	416	CX49-G	397
9899 CV/C	111	C45PRO A2/R915	474	C45PW/3-2,0MT	464	C55PRO B-D4	417	G,K	
C		C45PRO ACT	469	C45PX/1-0,7MT	463	C55PS	430	GM	560
C04TSS-7	380	C45PRO AS1	473	C45PX/2-1,3MT	464	C55PSE	430	KIT 6VC/3C	476
C3	358	C45PRO AS2	474	C45PX/3-2,0MT	464	C55PT0,8x0,6	429	KIT 10VC/5C	477
C4 - 2104	358	C45PRO AW	458	C45STR	474	C55PT1,0x0,6	428	KIT/GPS	560
C5 - 2105	358	C45PRO AX	458	C48M	398	C55PTE-0,8	429	M	
C5S	358	C45PRO BPW-1,3	461	C48P	398	C55PTE-1,0	428	M01	533
C6T - 2106	358	C45PRO BPW-2,0	461	C51	399	C55RB	420	M02	533
C7 - 2107	358	C45PRO BPX-1,3	461	C54S	402	C55STR	435	M05	533
C7AT	359	C45PRO BPX-2,0	460	C55	412	C55T3	426	M06	533
C8 - 2108	359	C45PRO BW	459	C55 A1/RB42	433	C56	406	M06	533
C8B	359	C45PRO BX	458	C55/1PF	429	C56B	406	M13	533
C9 - 2109	359	C45PRO C5	464	C55/2PM	428	C56M	407	M25	533
C9/RT	359	C45PRO C7	465	C55/PF	427	C56P O	401	M30	533
C9DA	359	C45PRO CAI/W	472	C55/PL-1,024	420	C56PL O	401	M31	534
C9MT	360	C45PRO CAI/X	472	C55A1	433	C56W	406	M33	534
C9PT	321	C45PRO CORNER/W	472	C55A1/R42	433	C57SA	403	M38	534
C10 - 2110	360	C45PRO CORNER/X	471	C55A2	434	C57SB	404	M39	534
C10S - 2110S	360	C45PRO CPF	463	C55A2/R70	434	C57SC	404	M40	534
C11 - 2111	360	C45PRO CW	460	C55AB	413	C57SD	403	M44	534
C12 - 2112	361	C45PRO CX	460	C55AC	431	C57SP	405	M45	534
C13	361	C45PRO DX	455	C55AE	430	C58B	407	M46	534
C14	361	C45PRO DW	454	C55AT1	435	C58M	407	M49	534
C16 - 2116	362	C45PRO DX	454	C55AT2	435	C58P	405	M50	534
C18 - 2118	362	C45PRO EW	459	C55B PT/2	420	C59A	408	M52	535
C19-2119-C19L-2119L	362	C45PRO EX	459	C55B PT/2,8	420	C59B	408	M53	535
C20 - C20L - 2120	362	C45PRO FW	455	C55B/1	432	C59C	409	M55	535
C20TSS	363	C45PRO FX	455	C55B/2	415	C62M/WW	669	M60	535
C22B	363	C45PRO GW	456	C55B/2,8	416	C64/1	669	M62	535
C22P	363	C45PRO GX	456	C55B/G	418	C64CW	670	M63	535
C22W	363	C45PRO HW	457	C55B/GAA	418	C64G/1	670	M65	535
C25	380	C45PRO HX	457	C55B/GAE	419	C68	615	M67	535
C27S	381	C45PRO M3A	468	C55B/GAE	419	C68 G	615	M69	535
C30M	383	C45PRO M4	465	C55B/GDP	418	C68N	615	M75	535
C35/6GM	384	C45PRO M5	465	C55B/GDS	418	C88 R/1	615	M78	536
C35/7GM	385	C45PRO M7	466	C55B/GDS	418	C88NR/1	615	M79	536
C35/8GM	385	C45PRO M7A/W	462	C55B/GE	419	C88SE	615	M82	536
C35/9GM	385	C45PRO M7A/X	462	C55B/GE	419	C88VE	615	M83	536
C37/6	387	C45PRO M8	466	C55B/VS	420	C99	364	M85	536
C37/7	386	C45PRO M8	466	C55B-D4	417	C99C-V3	367	M86	536
C37/8	387	C45PRO MA	467	C55C7	421	C99P	367	M91	536
C37A/7	387	C45PRO MAL	467	C55C8	422	C99P12-V0	365	M92	536
C38	389	C45PRO MAT	468	C55CS	424	C99PC	367	M94	536
C38C	390	C45PRO MAT	468	C55KAI	431	C99PP	367	M96	536
C38L	389	C45PRO MAT	468	C55KAS	431	C99V0	364	M100	537
C38L A	389	C45PRO ML	468	C55M2	422	C99V0-P12	365	M105	537
C38T	390	C45PRO MP	471	C55M4	423	C99V1	365	M108	537
C39/6	392	C45PRO MS	466	C55M7	423	C99V2	366	M110	537
		C45PRO MWS/W	463	C55M8	424	C99V3/2C	366	M112	537
		C45PRO MWS/X	462	C55M8	424	CA49-G	397		
		C45PRO PAS	470	C55MA	425				
		C45PRO PF	470	C55MDO	425				
		C45PRO PFE	471	C55MP	431				
				C55MS	426				

ÍNDICE ALFANUMÉRICO

M115	537	MB58	545	RSC50 CS	447	T34	550	T177	555
M120	538	MB59	545	RSC50 D	440	T40	550	T180	555
M121	538	MB63	546	RSC50 E	440	T41	550	T183	555
M125	538	MB64	546	RSC50 F	440	T45	550	T198	555
M126	538	MB65	545	RSC50 G	439	T46	550	T199	555
M127	538	MC10	543	RSC50 H	439	T48	550	T201	555
M128	538	MC12	543	RSC50 I	438	T50	550	T202	555
M129	538	MC20	543	RSC50 KAI	451	T52	550	T204	555
M133	538	MC21	543	RSC50 KPF	449	T55	550	T205	556
M134	538	MM11	546	RSC50 L	438	T59	550	T206	556
M135	539	MM26	546	RSC50 M10	445	T63	550	T207	556
M136	539	MM30	546	RSC50 M4	444	T64	551	T208	556
M137	539	MM60	546	RSC50 M5	444	T65	551	T209	556
M145	539	MM63	546	RSC50 M7	445	T68	551	T211	556
M153	539	MM100	547	RSC50 M8	445	T73	551	T213	556
M161	539	MM105	547	RSC50 MA	447	T75	551	T216	556
M162	539	MM129	547	RSC50 MDO	448	T76	551	T221	556
M166	539	MM210	547	RSC50 ML	447	T77	551	T226	556
M170	539	MM230	548	RSC50 MS-2AVV	446	T80	551	T227	556
M172	539	MM400	548	RSC50 MS-2C	446	T81	551	T228	556
M174	540	MM401	548	RSC50 MS-AVV	446	T82	551	T231	557
M180	540	P		RSC50 MTP	450	T83	551	T233	557
M195	540			RSC50 P/1-0,7MT	442	T85	552	T234	557
M201	540	PM 1/2-Q5	72	RSC50 P/2-1,5MT	442	T91	552	T236	557
M204	540	PM/5C	477	RSC50 P/2MDX-SX	450	T92	552	T239	557
M208	540	PM/6C	477	RSC50 P/3-2,2MT	442	T99	552	T241	557
M209	540	PV	405	RSC50 PFI	449	T100	552	T259	557
M213	540	R		RSC50 PFS	449	T101	552	T264	557
M214	540			RSC50 PM	450	T102	552	T270	557
M216	540	RSC22	368	RSC50 PS	451	T103	552	T273	557
M217	540	RSC23	369	RSC50 RB	443	T105	552	T279	558
M218	541	RSC23C	369	RSC50 T3	448	T106	552	T281	557
M219	541	RSC23T	370	RSC51	399	T111	552	T284	558
M222	541	RSC24/5	372	S		T112	553	T291	558
M226	541	RSC24/6	372				T113	553	T294
M227	541	RSC24/7	371	S42/17	561	T122	553	T297	558
M230	541	RSC24/8	372	S55/12	560	T123	553	TSPP	560
M231	541	RSC24A/6	373	S55/8	560	T124	553	V	
M234	541	RSC24A/7	373	S951/6	561	T135	553		
M236	541	RSC24A/8	373	S952/10	560	T136	553	VE1	560
M237	542	RSC24AXL/7	374	S96T/8	561	T137	553	VP-3SC	559
M240	542	RSC24AXL/8	375	S1719BM	561	T138	553	VP-LD	559
M264	542	RSC24AXL/9	375	SB	560	T140	553	VP-LS	559
M284	542	RSC24AXLP/7	376	SGN	561	T144	553	VP1 - VP2	559
M292	542	RSC24L/7	379	SP5S	478	T145	553	VP3 - VP4	559
M294	542	RSC24L-CAB	379	SPC	478	T146	554	VP5	559
M295	542	RSC28	382	SPG11 - S1203/8	561	T151	554	VP6	559
M305	542	RSC50	439	SSPE	473	T153	554	VPM0	548
M310	542	RSC50 A	441	ST2P	560	T156	554	VPM3	548
M400	543	RSC50 A1	452	T		T157	554	VPM7	548
M401	543	RSC50 A1/R59	452				T160	554	VPM7-C
MB	560	RSC50 A1/RB59	452	T01	549	T161	554	VPM8	548
MB12	544	RSC50 A2	452	T05	549	T164	554	VPM9	548
MB37	544	RSC50 A2/R91	453	T06	549	T167	554		
MB38	544	RSC50 AC	451	T18	549	T168	554		
MB39	544	RSC50 B	441	T19	549	T170	554		
MB44	544	RSC50 C	441	T22	549	T171	554		
MB45	545	RSC50 C5	443	T23	549	T172	555		
MB46	545	RSC50 C7	443	T31	549	T173	555		
MB47	545	RSC50 C8	444	T33	550	T175	555		
MB56	545					T176	555		

GRUPO BETA

OS NÚMEROS



www.gruppo-beta.com



10 unidades de
produção
EM ITÁLIA



1.000
colaboradores

BETA UTENSILI S.p.A. - 20845 Sovico (MB)
Via A. Volta, 18 - Tel. 039.2077.1 - Fax 039.2010742
www.beta-tools.com

11 filiais em
todo o mundo

Atividade em mais
de **100 países**
com mais de
250
importadores



Robur Wire rope accessories:
67039 Sulmona (AQ) Zona industriale - C.da S. Nicola
Tel. 0864.2504.1 - Fax 0864.253132
www.roburitaly.com - info@roburitaly.com

A HISTÓRIA DAS FERRAMENTAS ITALIANAS

- 1923** ● Alessandro Ciceri fundou a “Alessandro Ciceri & Figli”, em Erba (na província de Como), dedicada ao fabrico de peças fundidas em ferro e aço.
- 1939** ● A marca Beta foi registrada e a Empresa passou a dedicar-se sobretudo ao fabrico de ferramentas profissionais na fábrica de Sovico (na província de Monza e Brianza), onde ainda está sediada.
- 1960** ● A Beta Utensili contava com cerca de duzentos colaboradores, estabeleceu-se como fabricante de ferramentas manuais profissionais e exportou os seus produtos.
- 1969** ● Foi lançado o revolucionário carro “Tank” em chapa cor de laranja; a partir desse momento a cor laranja resultaria num estilo único para a marca Beta.
- 1971** ● A Beta Utensili entrou no mundo do automobilismo – primeiro na Fórmula 1 e depois nos ralis e nos desportos motorizados em geral.
- 1973** ● Foi inaugurada a fábrica de Castiglione d’Adda (na província de Lodi), juntando-se assim à já estabelecida fábrica em Sovico (na província de Monza e Brianza).
- 1975** ● Conquistou a sua primeira vitória na Fórmula 1, com o March-Beta Utensili laranja pilotado por Vittorio Brambilla, que venceu o Grande Prémio da Áustria em Zeltweg, sob chuva torrencial.
- 1980** ● A Beta Utensili penetrou ainda mais nos principais mercados europeus, estabelecendo filiais em França, Grã-Bretanha, Holanda, Espanha, Polónia e Hungria.
- 1984** ● A Empresa inaugurou a sua terceira fábrica em Sulmona (na província de L’Aquila). Começou a fabricar as icónicas chaves combinadas, item 42. A produção e os testes de acessórios de elevação tiveram início sob a marca Robur.
- 2000** ● O lançamento do novo catálogo Beta Utensili testemunhou o crescimento contínuo. A gama de produtos disponíveis foi duplicada e as mais de 10 mil referências foram divididas em 22 famílias de produtos.
- 2002** ● A gama da Beta Utensili foi ampliada, sendo complementada com calçado de segurança e também com a coleção de trabalho e lazer “Beta Work”.
- 2009** ● A Beta começou a expandir-se, estabelecendo a Beta China e, três anos depois, a Beta no Brasil.
- 2016** ● A Beta lançou o novo sistema modular de equipamentos de oficina, RSC55.
- 2018** ● O Grupo Beta expandiu-se ainda mais ao adquirir a BM S.p.A., fabricante líder de terminais e sistemas de ligação elétrica, a 3D Beta S.r.l., empresa especializada na conceção e produção de sistemas modulares de equipamentos de oficina personalizados, e a VGF S.r.l., empresa especializada na pintura de mobiliário em metal.
- 2019** ● A estratégia de crescimento do Grupo Beta foi acelerada com a aquisição dos principais fabricantes de abrasivos, Abra Beta S.p.A. e Elpa Abrasivi S.r.l.
- 2020** ● Foi criada a Beta Tools USA como um grande passo para a expansão no mercado norte-americano.
- 2023** ● A Empresa adquiriu a Helvi S.p.A., importante player na indústria de soldadura de metais. Assim, o Grupo Beta ultrapassa atualmente os 1.000 colaboradores em todo o mundo, 40 famílias de produtos e mais de 30.000 referências, desenvolvidos para satisfazer as exigências dos profissionais e proporcionar qualidade e desempenho a longo prazo, de acordo com o princípio ‘Beta Well Done’, porque nós na Beta fazemos apenas bem feito.



1923 Alessandro Ciceri & Figli



1939 Ofi cina de Forja



1955 Ofi cina de Corte



1960 Departamento de Design



1969 Tank trolley



1974 Anúncio a jogos de ferramentas



1975 Vittorio Brambilla



2002 “BetaWork”



2016 Mobiliário de Oficina RSC55



2023 Fabio Quartararo, Embaixador da Beta

QUALIDADE CERTIFICADA

Em 2018 os carros de ferramentas Beta receberam a prestigiada certificação TÜV, após passarem por rigorosos testes de acordo com o protocolo EK5/TA5.

O protocolo EK5/TA5 verifica 31 características de construção bem definidas, exigentes testes estáticos e de comportamento dinâmico. Outros testes determinam a resistência a altas e baixas temperaturas, a vida útil das marcações e a resistência à corrosão.

O mérito por essa conquista deve-se ao design especializado, ao fabrico preciso e aos testes rigorosos aos quais a Beta submete os seus carros de ferramentas, o que permitiu que a sua qualidade fosse reconhecida pelos utilizadores.



CONTROLO E QUALIDADE



Na Beta, a qualidade tem um significado simples e concreto: “aquilo que satisfaz plenamente as necessidades e expectativas dos utilizadores profissionais que dependem dos nossos produtos como um instrumento de trabalho insubstituível”. As ferramentas não são apenas concebidas e fabricadas para satisfazer apenas uma necessidade, mas para garantir performances consistentes ao longo do tempo. Na Beta, a qualidade significa mais do que uma mera política de fabrico e vendas atenta, englobando todos os departamentos da empresa no sentido de atingir metas cada vez mais ambiciosas em termos de satisfação do cliente. A Beta tem construído a sua história com base neste mesmo conceito.



**Qualidade Beta,
A nossa prova
mais concreta**



**A qualidade
das ferramentas Beta
é uma sinergia
entre técnicas
tradicionais e novas
tecnologias.**



Desde 1995 os nossos processos de produção têm respeitado os padrões do Sistema de Qualidade ISO 9001



LOGÍSTICA



**30.000 m²
de superfície**



40.000
referências
e mais de **27.000**
unidades de carga



**Entregas rápidas,
precisas
e completas**



ORGANIZAÇÃO DO TRABALHO

consiste num método de organização do espaço de trabalho de origem japonesa. O nome deriva da transcrição ocidental de 5 palavras japonesas: **seiri, seiton, seiso, seiketsu and shitsuke**.

Ao seguir os 5 passos anteriormente identifi cados, é possível implementar um método sistemático e consistente, com planos de trabalho otimizados e funcionais.



SEIRI

ORGANIZAÇÃO

Retire todos os itens/produtos desnecessários do espaço de trabalho; Mantenha apenas o necessário.



SEITON

ORDEM

Coloque tudo no seu devido lugar: um lugar para tudo e tudo no seu lugar.



SEISO

LIMPEZA

Mantenha o espaço de trabalho limpo e arrumado.



SEIKETSU

PADRONIZAÇÃO

Estabeleça práticas de trabalho consistentes para racionalizar os recursos e espaços, defini dos com a implementação de um padrão.



SHITSUKE

SUSTENTABILIDADE

Apoie e divulgue este método de organização.



BENEFÍCIOS



Economia de tempo, relação custo/ eficiência melhorada



Melhor qualidade e produtividade



Acidentes de trabalho reduzidos



Maior eficiência



ANTES



DEPOIS

PRESENÇA EFICAZ



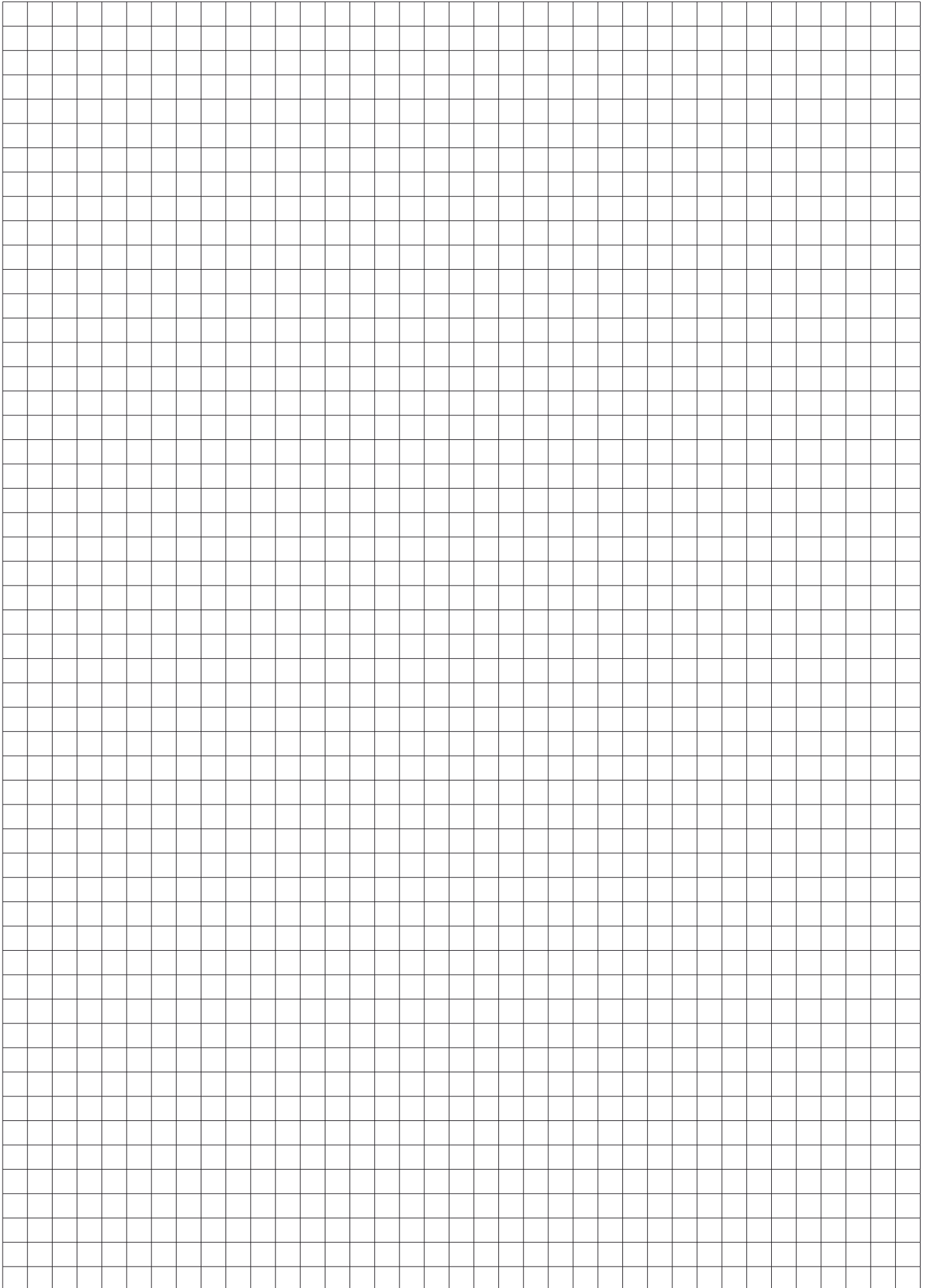

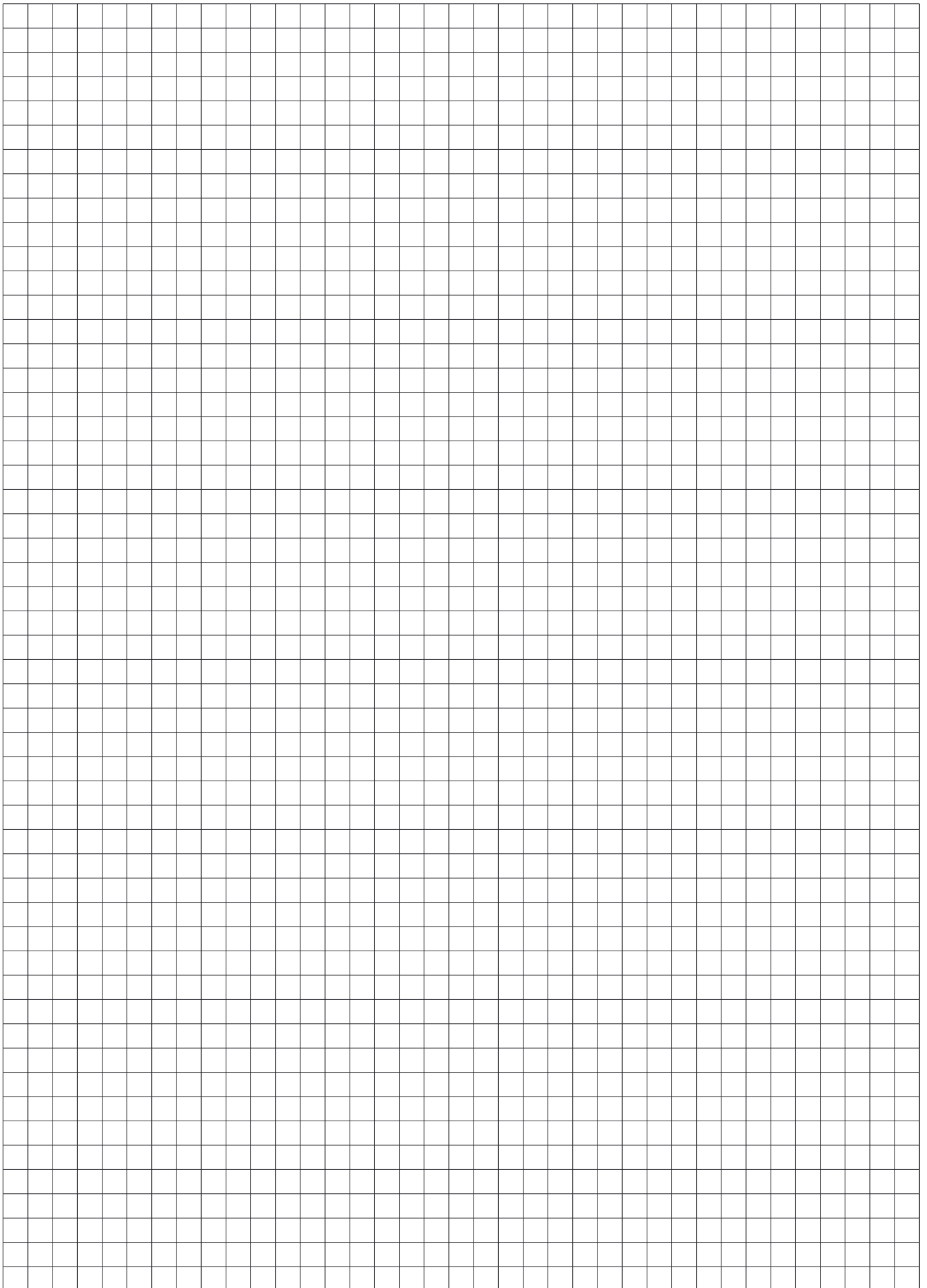

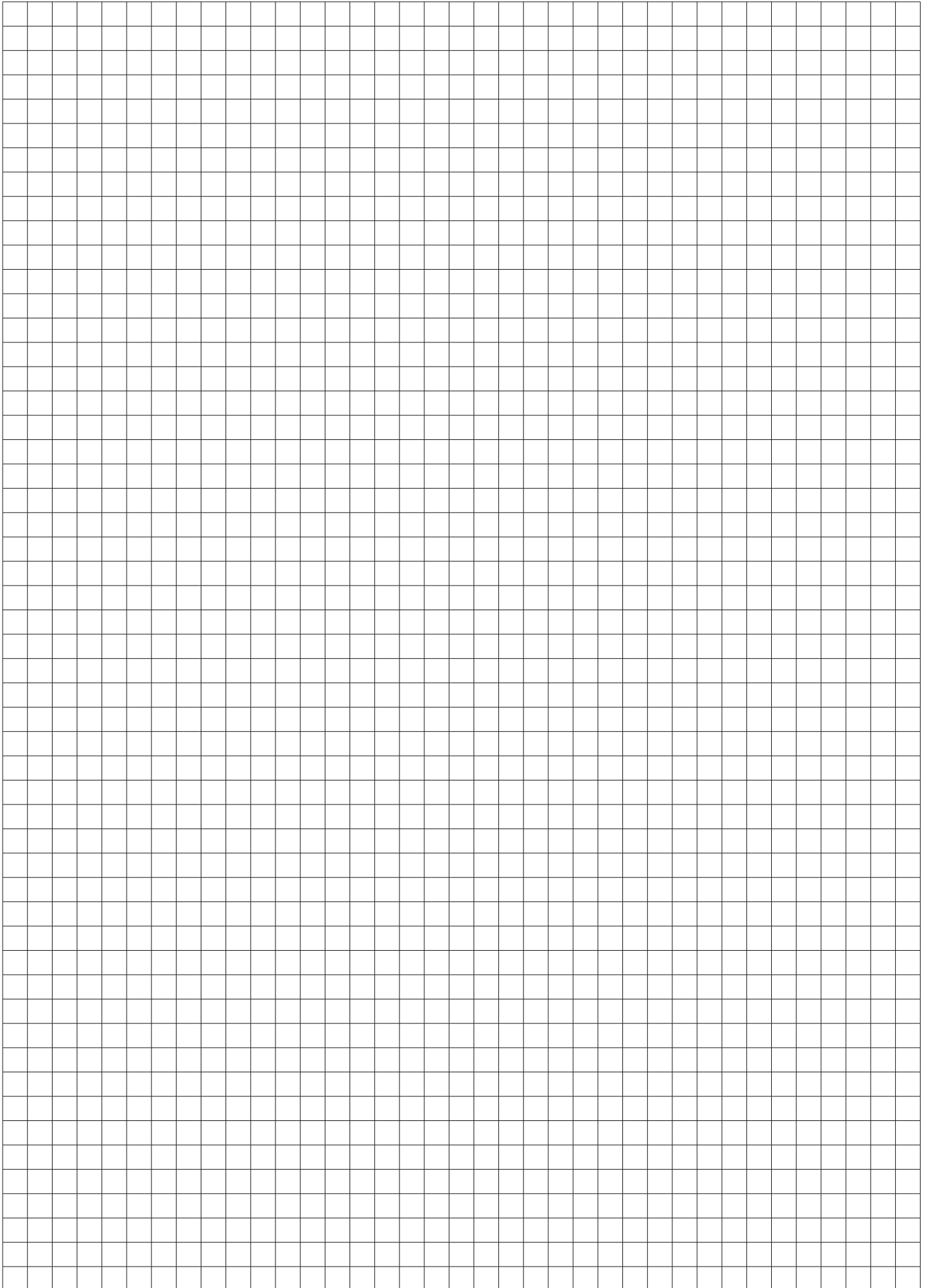

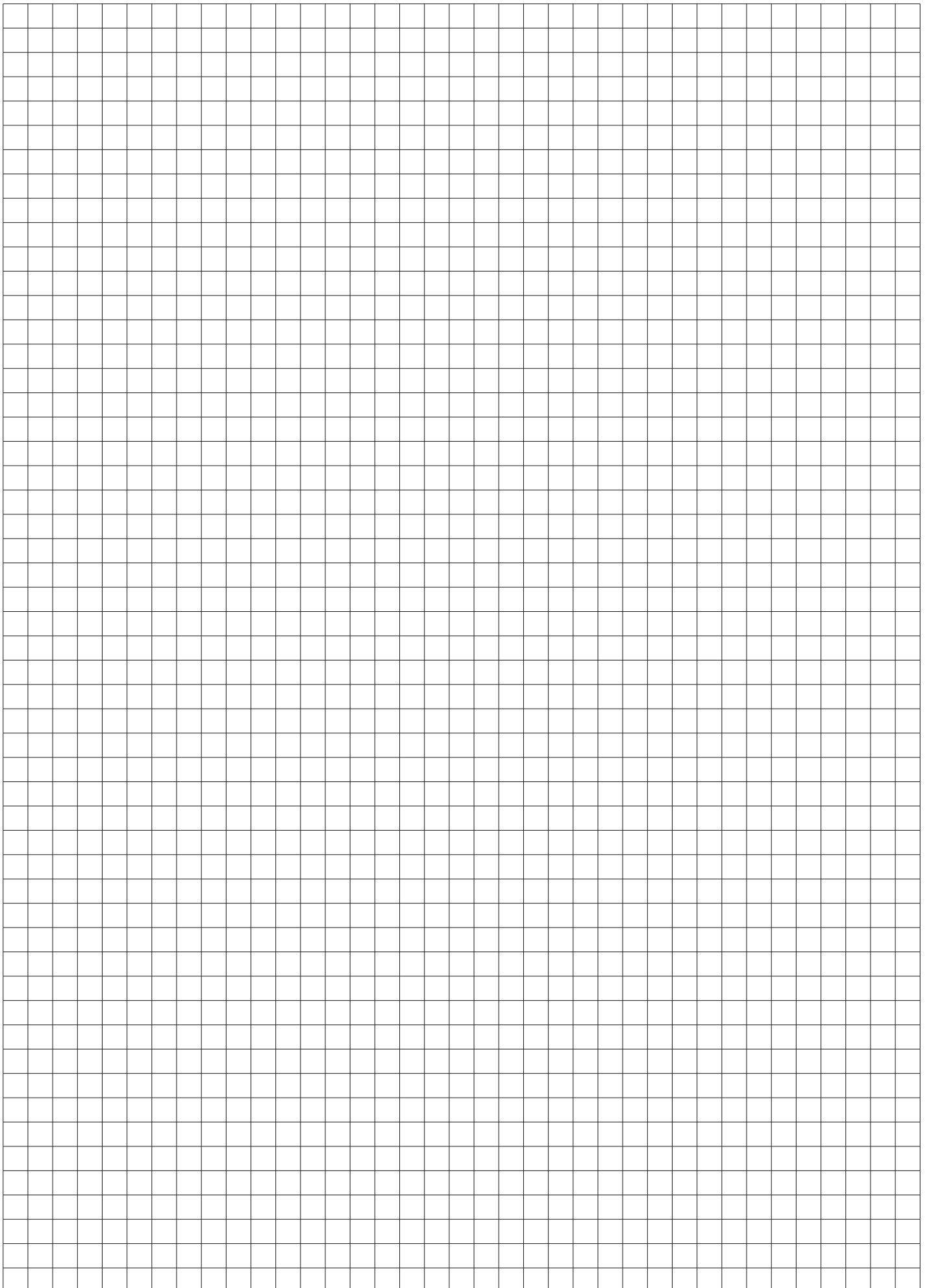

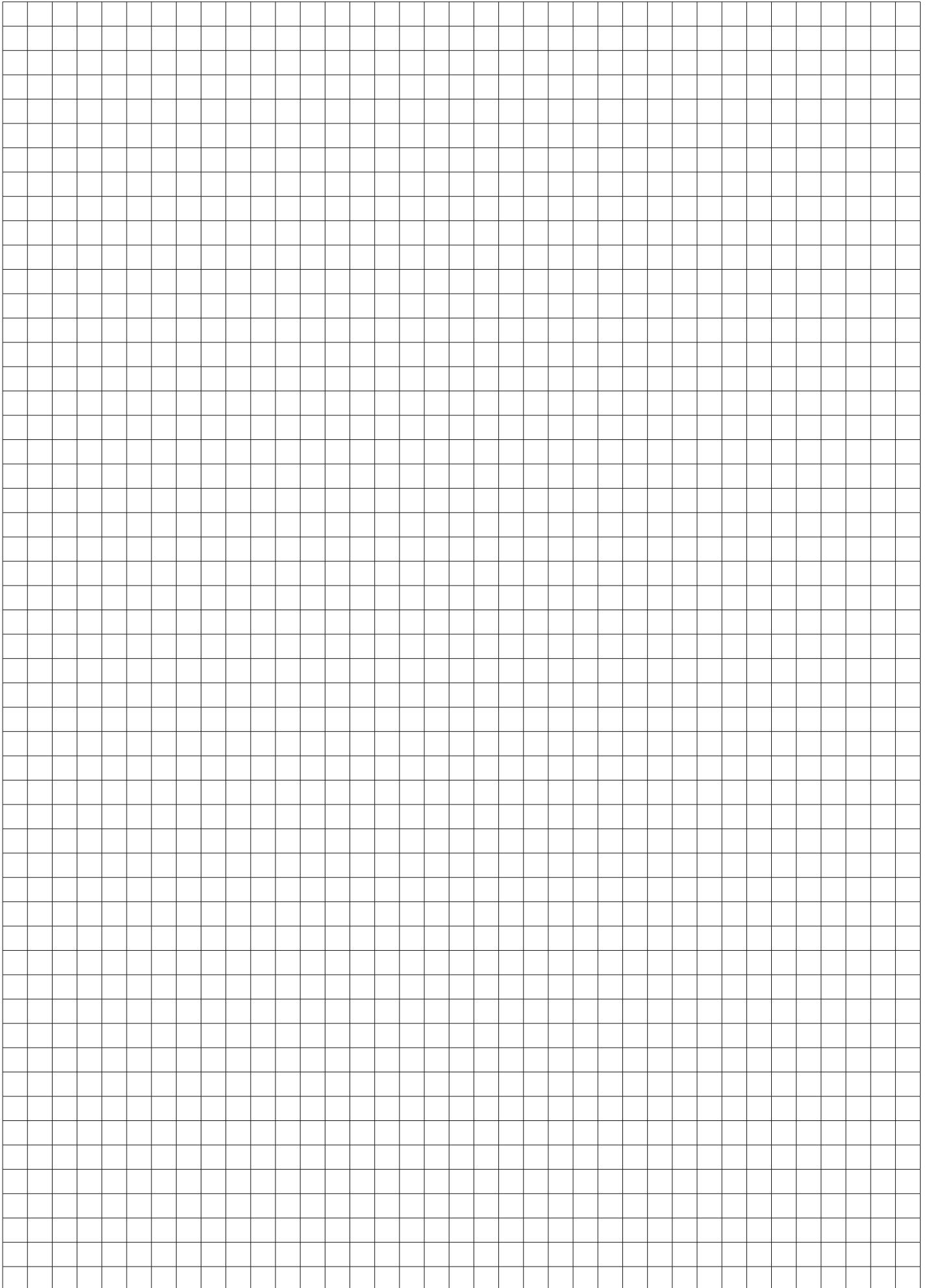

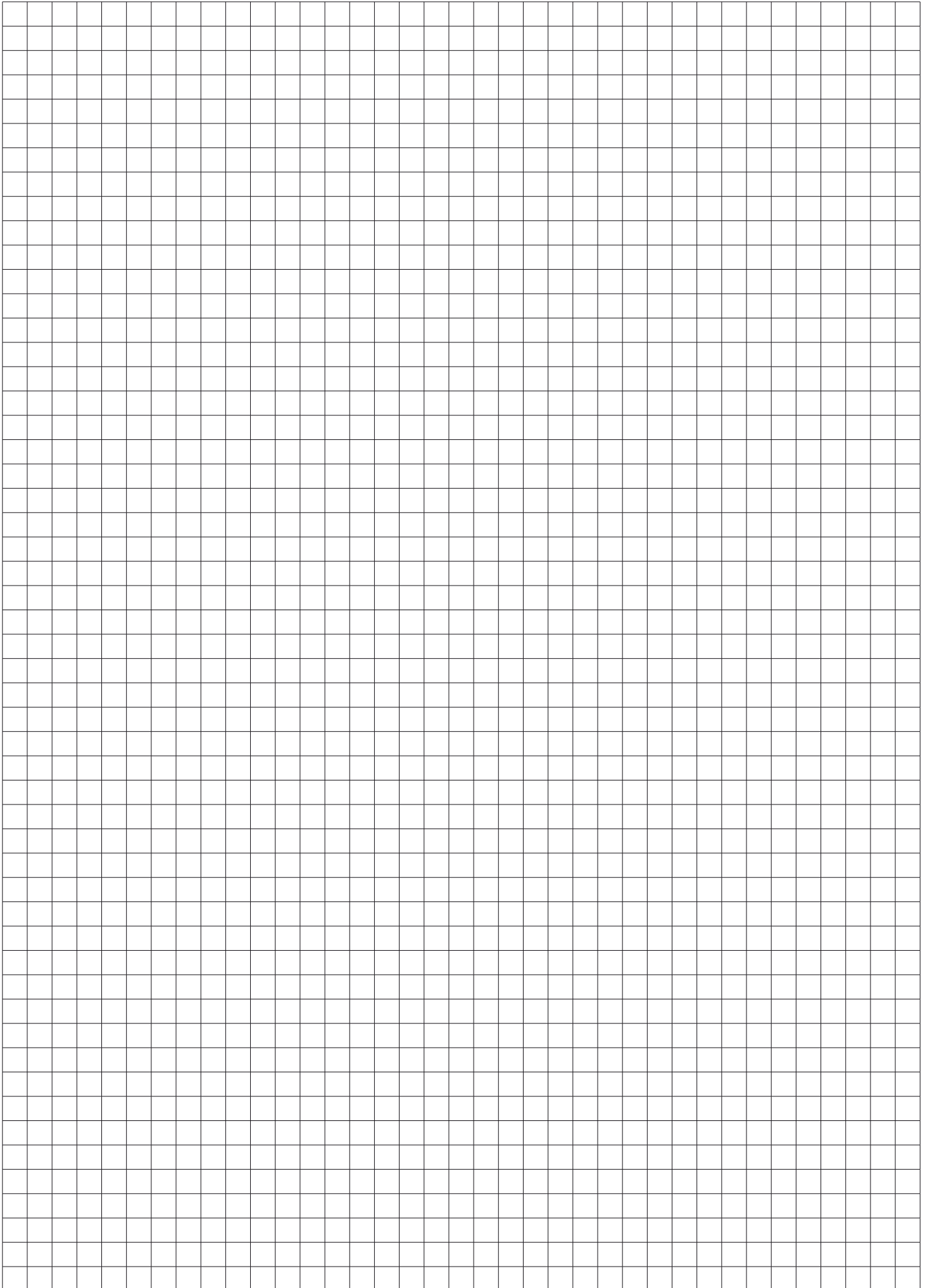

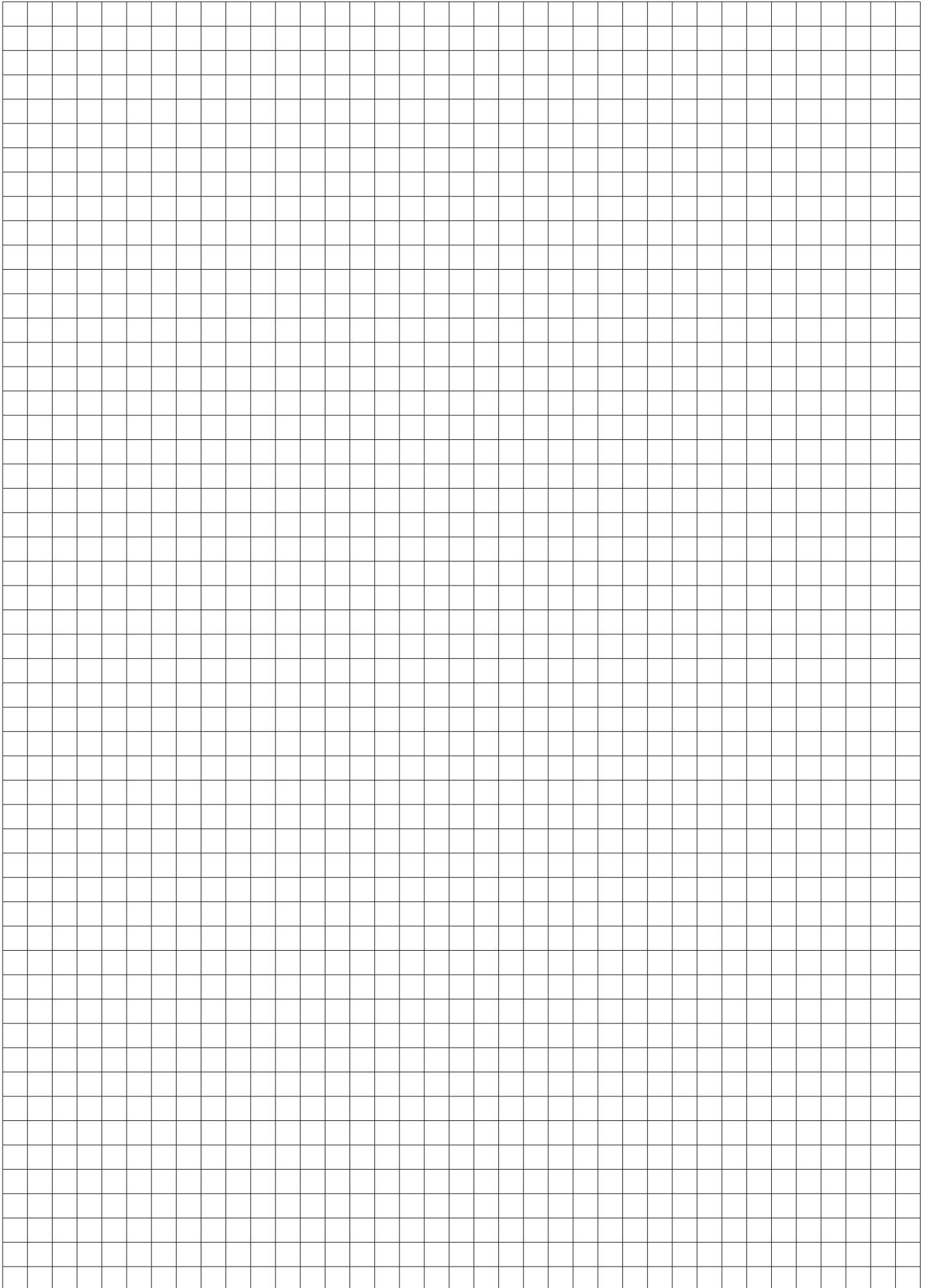

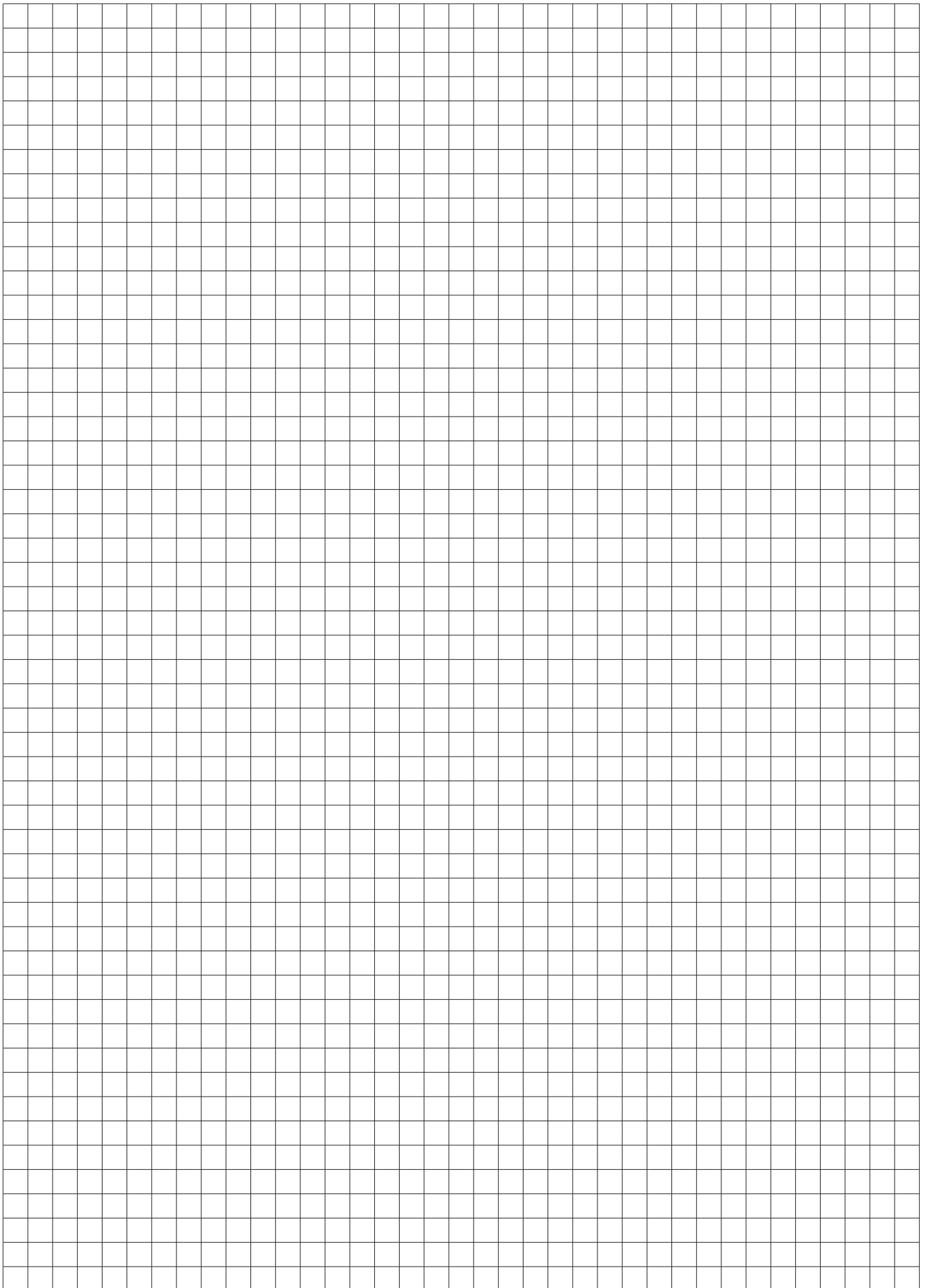

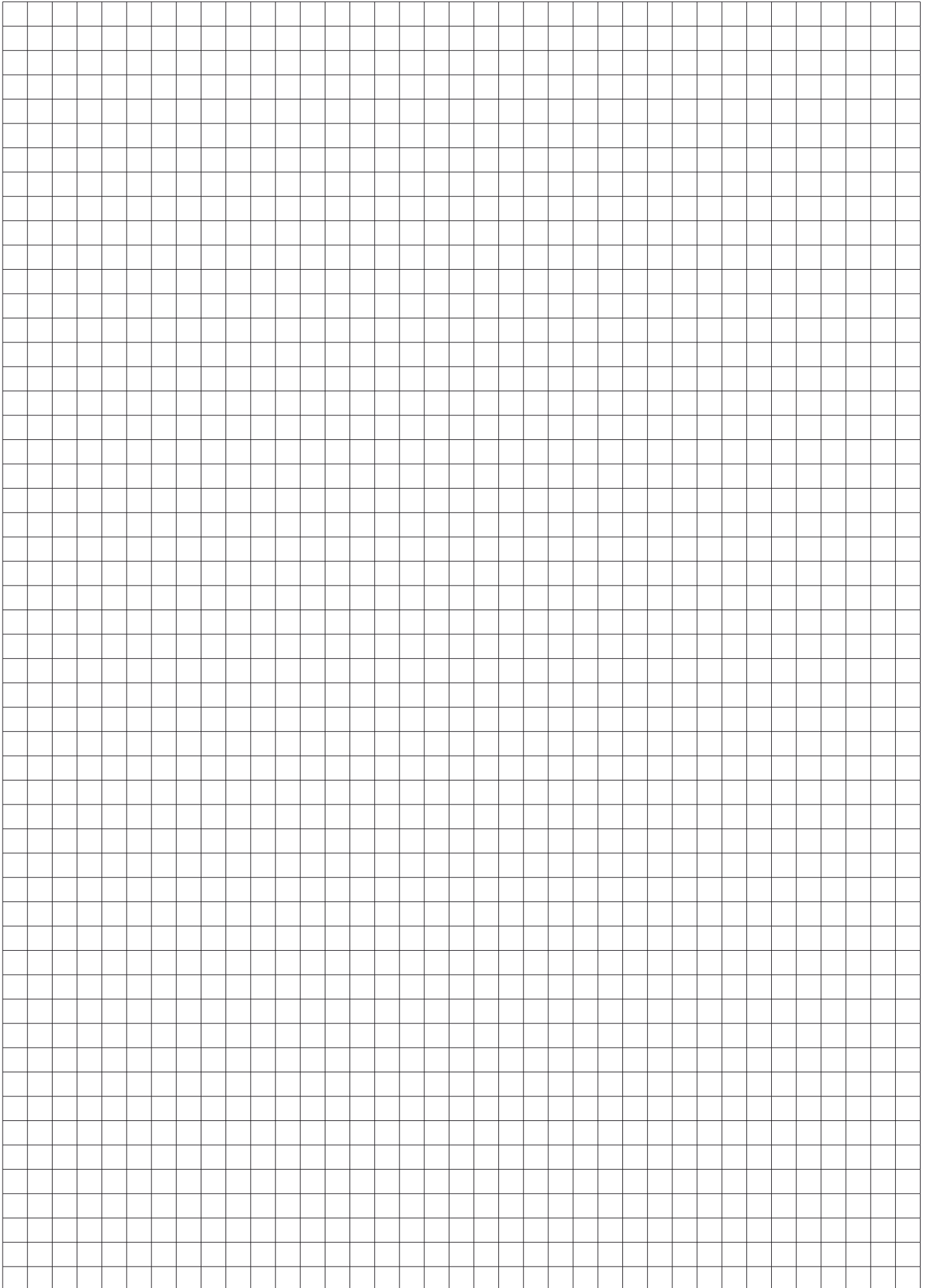

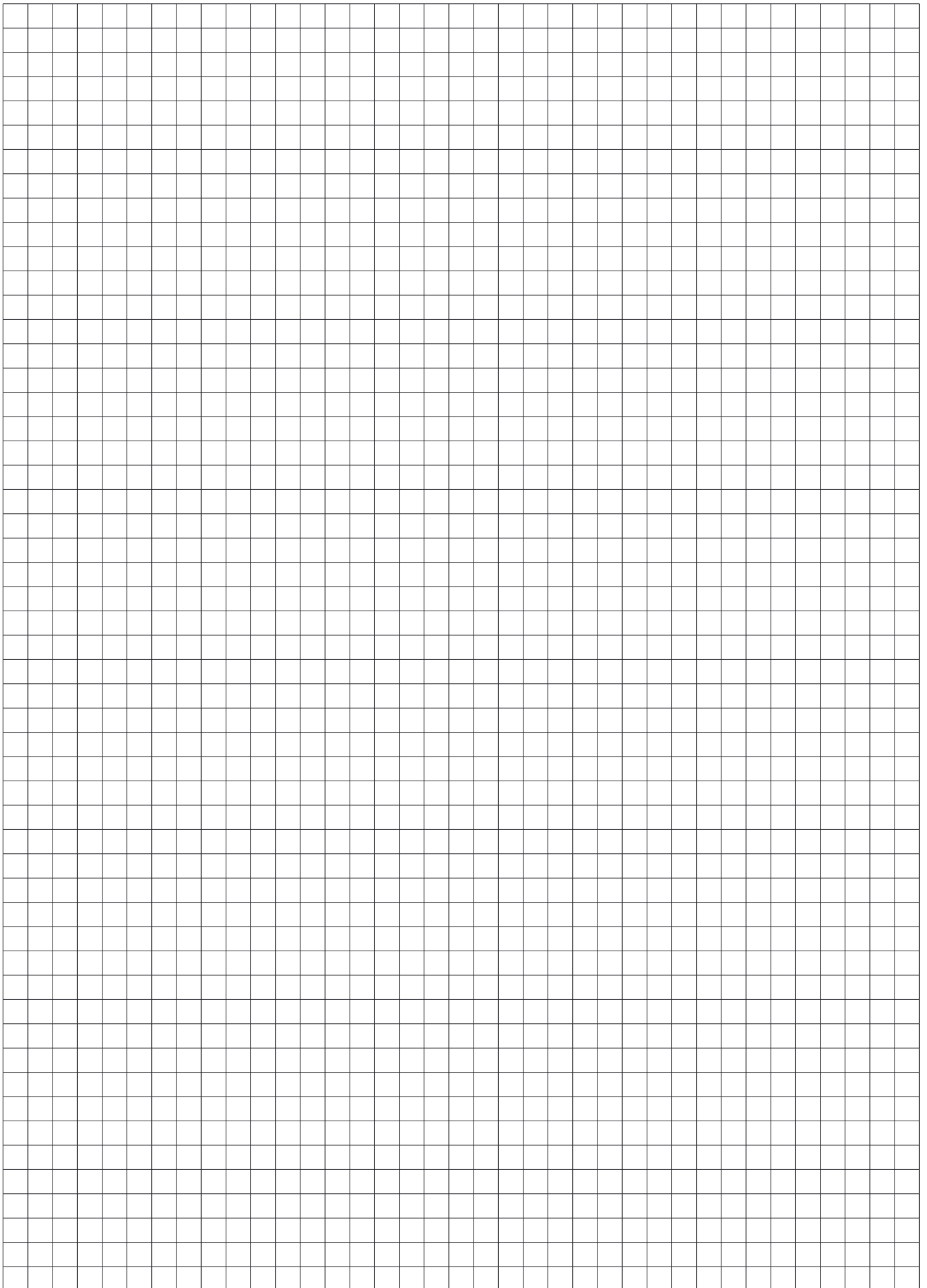

2023 Moto2
World Championship



**FERMÍN
ALDEGUER**



 **Beta**

50 Years in Motorsports

2023

PARTNERSHIP



 **Beta**
AMBASSADOR

FABIO QUARTARARO
2023 MotoGP
World Championship

